

For air-conditioner fan motor

3-Phase Brushless Fan Motor Driver



BM6202FS

● General Description

This motor driver IC adopts PrestoMOS™ as the output transistor, and put in a small full molding package with the high voltage gate driver chip. The protection circuits for overcurrent, overheating, under voltage lock out and the high voltage bootstrap diode with current regulation are built-in. It provides optimum motor drive system for a wide variety of applications by the combination with controller BD6201X series and enables motor unit standardization.

● Features

- 600V PrestoMOS™ built-in
- Output current 1.5A
- Bootstrap operation by floating high side driver (including diode)
- 3.3V logic input compatible
- Protection circuits provided: OCP, TSD and UVLO
- Fault output (open drain)

● Applications

- Air conditioners; air cleaners; water pumps; dishwashers; washing machines
- General OA equipment

● Key Specifications

- Output MOSFET voltage: 600V
- Driver output current (DC): ±1.5A(Max.)
- Driver output current (Pulse): ±2.5A(Max.)
- Output MOSFET DC on resistance: 2.7Ω (Typ.)
- Operating case temperature: -20°C to +100°C
- Junction temperature: +150°C
- Power dissipation: 3.0W

● Package

SSOP-A54_23

W (Typ.) x D (Typ.) x H (Max.)
22.0 mm x 14.1 mm x 2.4 mm

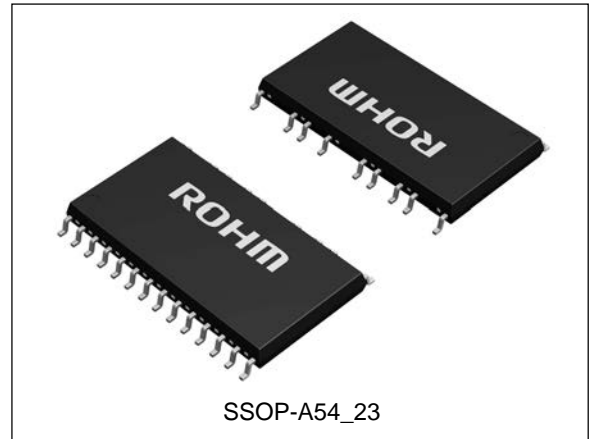

● Typical Application Circuit

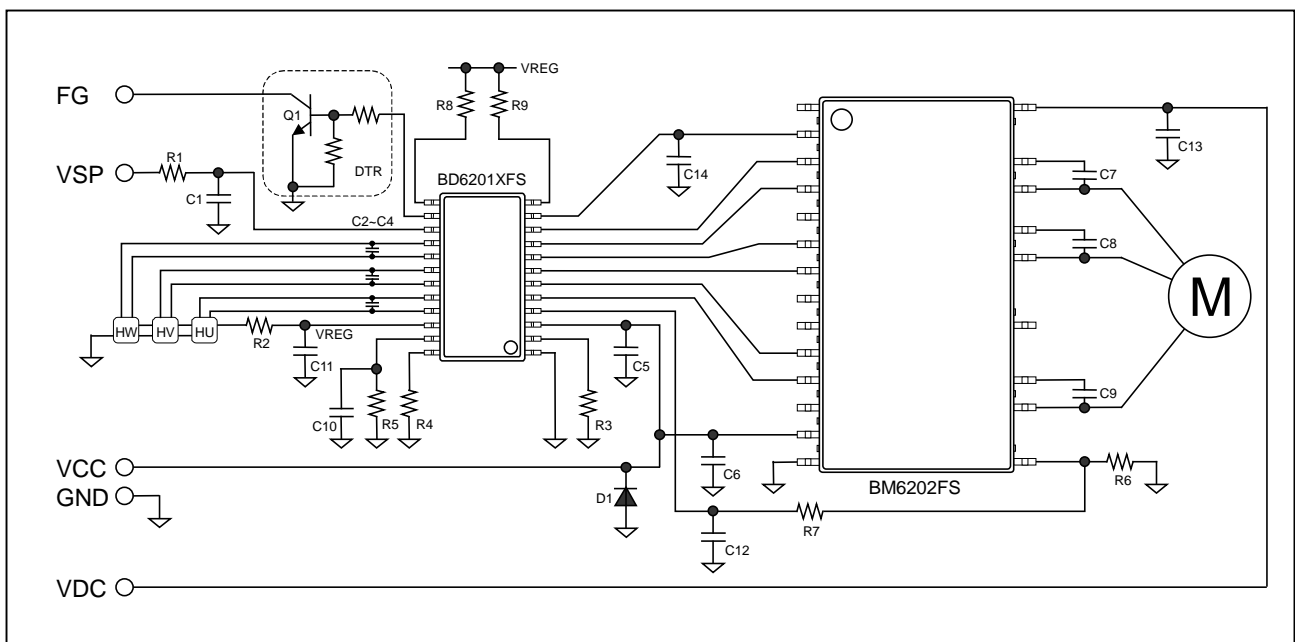

Figure 1. Application circuit example - BM6202FS & BD6201XFS

● Block Diagram and Pin Configuration

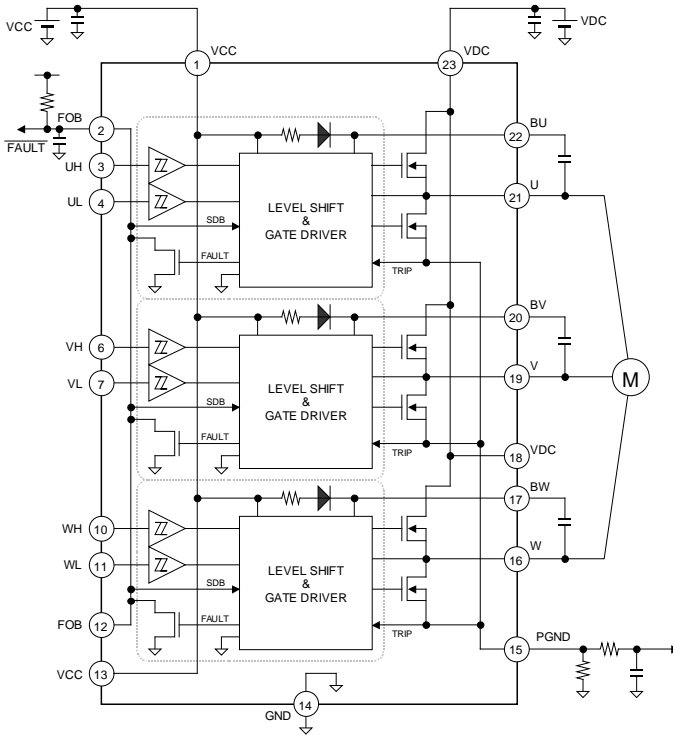

Figure 2. Block diagram

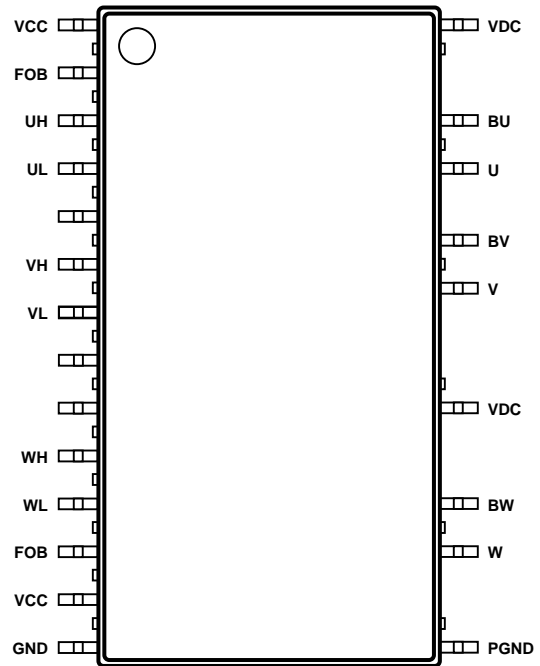

Figure 3. Pin configuration

● Pin Descriptions (NC: No Connection)

Pin	Name	Function	Pin	Name	Function
1	VCC	Low voltage power supply	23	VDC	High voltage power supply
2	FOB	Fault signal output (open drain)	-	VDC	
3	UH	Phase U high side control input	22	BU	Phase U floating power supply
4	UL	Phase U low side control input	-	U	
5	NC		21	U	Phase U output
6	VH	Phase V high side control input	20	BV	Phase V floating power supply
7	VL	Phase V low side control input	-	V	
8	NC		19	V	Phase V output
9	NC		-	VDC	
10	WH	Phase W high side control input	18	VDC	High voltage power supply
11	WL	Phase W low side control input	17	BW	Phase W floating power supply
12	FOB	Fault signal output (open drain)	-	W	
13	VCC	Low voltage power supply	16	W	Phase W output
14	GND	Ground	15	PGND	Ground (current sense pin)

Note) All pin cut surfaces visible from the side of package are no connected, except the pin number is expressed as a "-".

● Functional Descriptions

1) Control input pins (UH, UL, VH, VL, WH, WL)

The input threshold voltages of the control pins are 2.5V and 0.8V, with a hysteresis voltage of approximately 0.4V. The IC will accept input voltages up to the VCC voltage. When the same phase control pins are input high at the same time, the high side and low side gate driver outputs become low. Dead time is installed in the control signals. The control input pins are connected internally to pull-down resistors (100kΩ nominal). However, the switching noise on the output stage may affect the input on these pins and cause undesired operation. In such cases, attaching an external pull-down resistor (10kΩ recommended) between each control pin and ground, or connecting each pin to an input voltage of 0.8V or less (preferably GND), is recommended.

Truth table

HIN	LIN	HO	LO
L	L	L	L
H	L	H	L
L	H	L	H
H	H	Inhibition	

Note) HIN: UH,VH,WH, LIN: UL,VL,WL

2) Under voltage lock out (UVLO) circuit

To secure the lowest power supply voltage necessary to operate the driver, and to prevent under voltage malfunctions, the UVLO circuits are independently built into the upper side floating driver and the lower side driver. When the supply voltage falls to V_{UVL} or below, the controller forces driver outputs low. When the voltage rises to V_{UVH} or above, the UVLO circuit ends the lockout operation and returns the chip to normal operation. Even if the controller returns to normal operation, the output begins from the following control input signal.

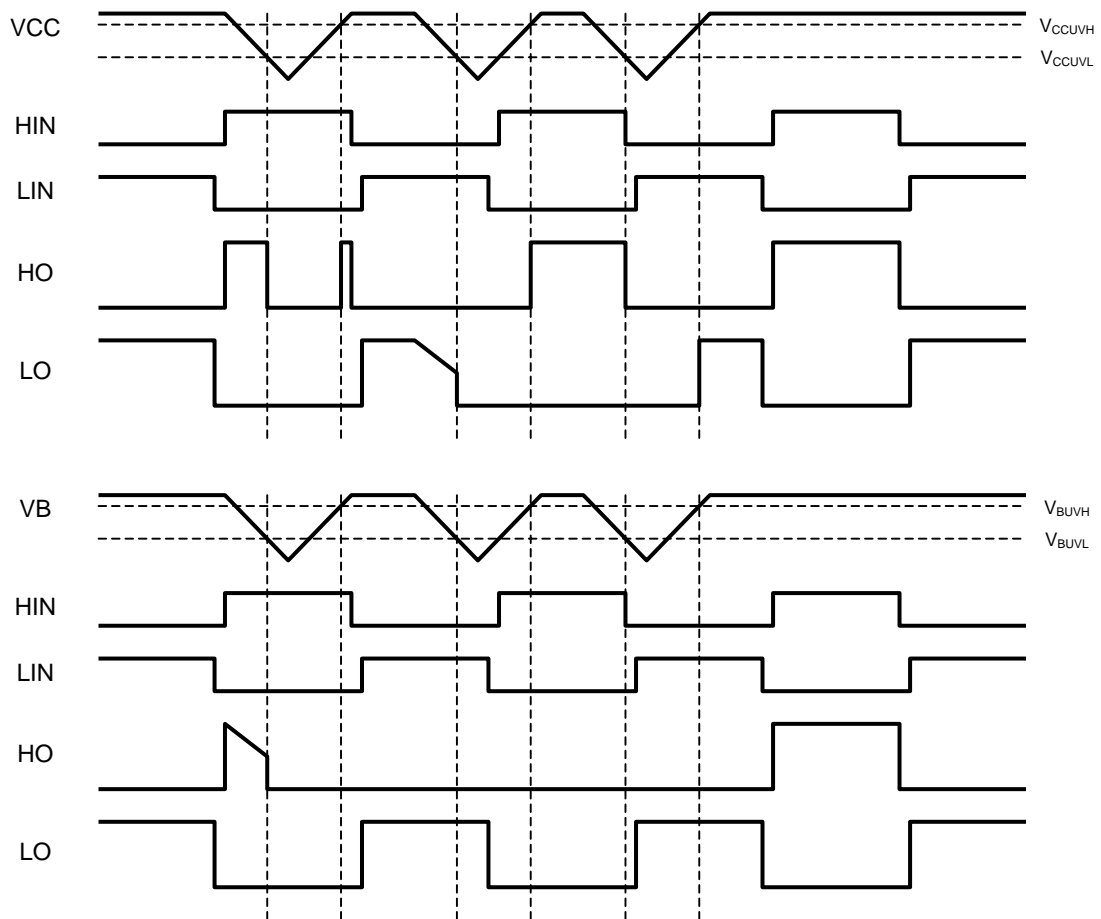

Figure 4. Low voltage monitor - UVLO - timing chart

3) Bootstrap operation

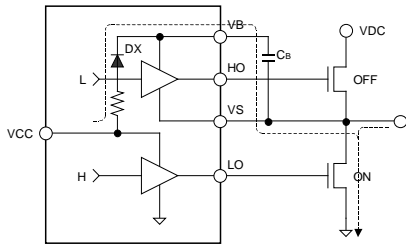

Figure 5. Charging period

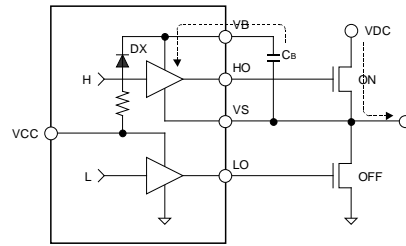

Figure 6. Discharging period

The bootstrap is operated by the charge period and the discharge period being alternately repeated for bootstrap capacitor (CB) as shown in the figure above. In a word, this operation is repeated while the output of an external transistor is switching with synchronous rectification. Because the supply voltage of the floating driver is charged from the VCC power supply to CB through prevention of backflow diode DX, it is approximately (VCC-1V). The resistance series connection with DX has the impedance of approximately 200 Ω.

The capacitance value for the bootstrap is the following formula:

Example:

- Floating driver power supply quiescence current $I_{BBQ} : 150\mu A(\text{max.})$
- Bootstrap diode reverse bias current $I_{LBD} : 10\mu A(\text{max.})$
- Carrier frequency $F_{PWM} : 20\text{kHz}$
- Output MOSFET total gate charge $Q_g : 25\text{nC}(\text{max.})$
- Floating driver transmission loss $Q_{LOSS} : 1\text{nC}(\text{max.})$
- Drop voltage of the floating driver power supply $dV_{DROP} : 3\text{V}$

$$C_{BOOT} \gg ((I_{BBQ} + I_{LBD}) / F_{PWM} + 2 \times Q_g + Q_{LOSS}) / dV_{DROP} \approx 20\text{nF}$$

The allowed drop voltage actually becomes smaller by the range of the used power supply voltage, the output MOSFET ON resistance, the forward voltages of the internal boot diode (the drop voltage to the capacitor by the charge current), and the power supply voltage monitor circuits etc. Please set the calculation value to the criterion about the capacitance value tenfold or more to secure the margin in consideration of temperature characteristics and the value change, etc. Moreover, the example of the mentioned above assumes the synchronous rectification switching. Because the total gate charge is needed only by the carrier frequency in the upper switching section, for example 150° commutation driving, it becomes a great capacity shortage in the above settings. Please set it after confirming actual application operation.

4) Thermal shutdown (TSD) circuit

The TSD circuit operates when the junction temperature of the gate driver exceeds the preset temperature (150°C nominal). At this time, the controller forces all driver outputs low. Since thermal hysteresis is provided in the TSD circuit, the chip returns to normal operation when the junction temperature falls below the preset temperature (125°C nominal). The TSD circuit is designed only to shut the IC off to prevent thermal runaway. It is not designed to protect the IC or guarantee its operation in the presence of extreme heat. Do not continue using the IC after the TSD circuit is activated, and do not use the IC in an environment where activation of the circuit is assumed. Moreover, it is not possible to follow the output MOSFET junction temperature rising rapidly because it is a gate driver chip that monitors the temperature and it is likely not to function effectively.

5) Overcurrent protection (OCP) circuit

The overcurrent protection circuit can be activated by connecting a low value resistor for current detection between the PGND pin and the GND pin. When the PGND pin voltage reaches or surpasses the threshold value (0.9V typical), the gate driver outputs low to the gate of all output MOSFETs, thus initiating the overcurrent protection operation.

6) Fault signal output

When the gate driver detects either state that should be protected (UVLO / TSD / OCP), the FOB pin outputs low (open drain) for at least 25µs nominal. The FOB pin has wired-OR connection with each phase gate driver chip internally, and into another phase also entering the protection operation. Even when this function is not used, the FOB pin is pull-up to the voltage of 3V or more and at least a resistor with a value 10k Ω or more. Moreover, the signal from the outside of the chip is not passed because of the built-in analog filter, but the internal control signals (UVLO / TSD / OCP) pass the filter (2.0µs Min.) for the malfunction prevention by the switching noise, etc.

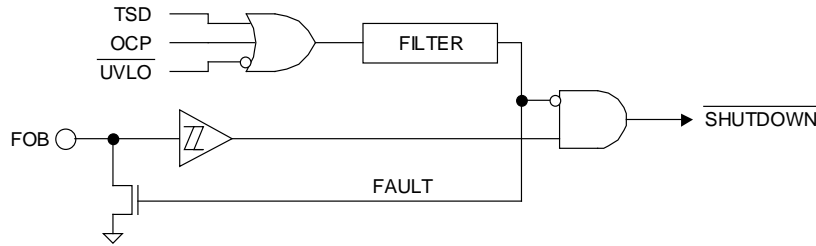

Figure 7. Fault signal bi-directional input pin interface

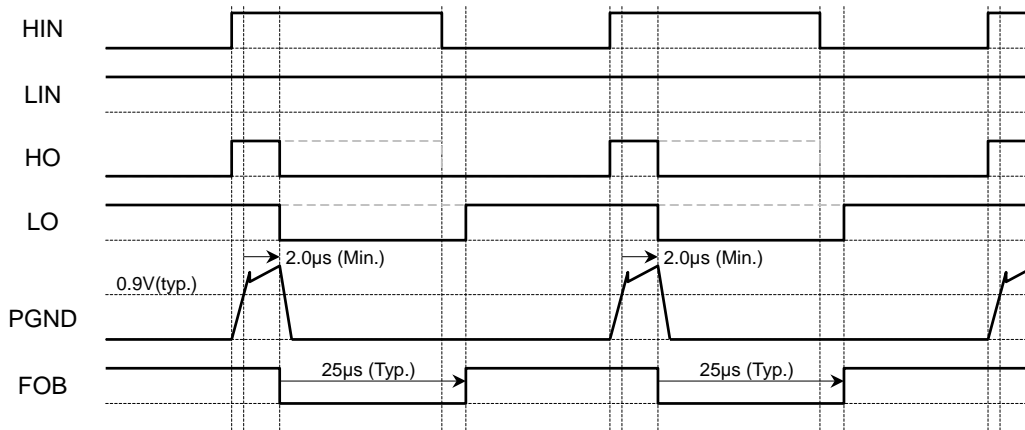

Figure 8. Fault operation ~ OCP ~ timing chart

The release time from the protection operation can be changed by inserting an external capacitor. Refer to the formula below. Release time of 2ms or more is recommended.

$$t = - \ln \left(1 - \frac{2.0}{VPU} \right) \cdot R \cdot C \text{ [s]}$$

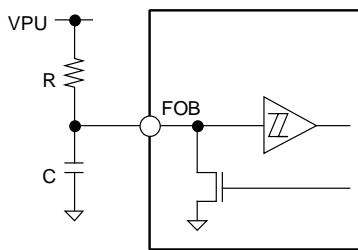

Figure 9. Release time setting application circuit

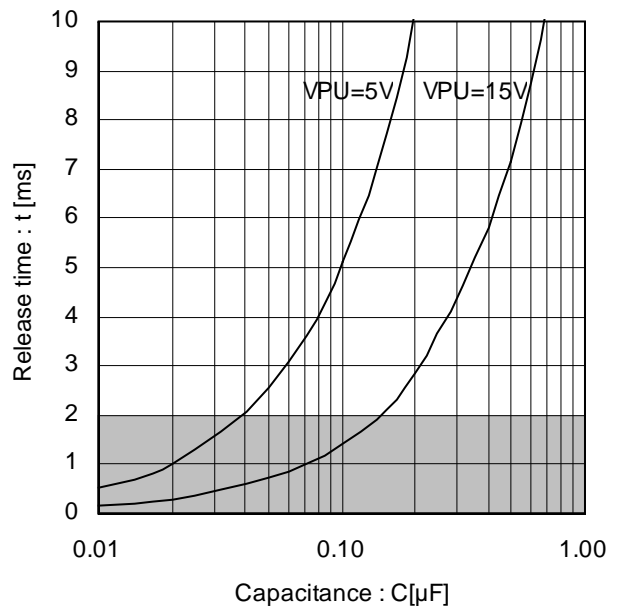

Figure 10. Release time (reference data @R=100kΩ)

When using controller BD6201X series as a control IC, the FOB pin can be linked to the external fault signal input pin of the side of the control IC since it has the internal pull-up resistor. Refer to figure 11.

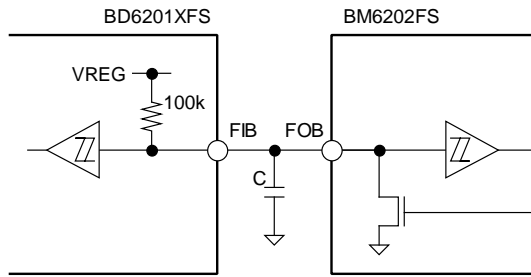

Figure 11. Interface equivalent circuit

7) Switching time

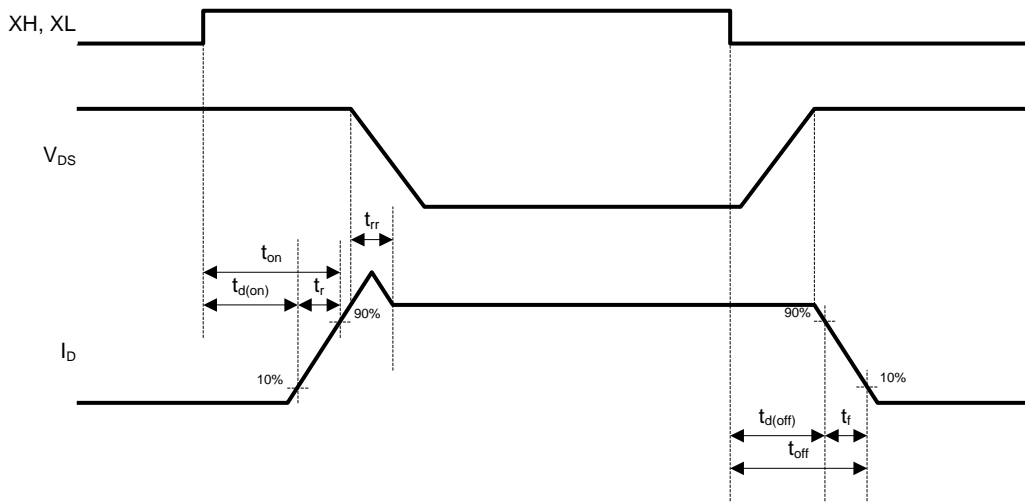

Figure 12. Switching time definition

Parameter	Symbol	Reference	Unit	Conditions
High side switching time	$t_{dH(on)}$	930	ns	VDC=300V, VCC=15V, I _D =0.75A VIN= 0V↔5V, Inductive load
	t_{rH}	170	ns	
	t_{rrH}	250	ns	
	$t_{dH(off)}$	600	ns	
	t_{fH}	20	ns	
Low side switching time	$t_{dL(on)}$	990	ns	
	t_{rL}	220	ns	
	t_{rrL}	250	ns	
	$t_{dL(off)}$	600	ns	
	t_{fL}	60	ns	

● Absolute Maximum Ratings (Ta=25°C)

Parameter	Symbol	Ratings	Unit
		BM6202FS	
Output MOSFET	V _{DSS}	600* ¹	V
Supply voltage	V _{DC}	-0.3 to 600* ¹	V
Output voltage	V _U , V _V , V _W	-0.3 to 600* ¹	V
High side supply pin voltage	V _{BU} , V _{BV} , V _{BW}	-0.3 to 600* ¹	V
High side floating supply voltage	V _{BU} -V _U , V _{BV} -V _V , V _{BW} -V _W	-0.3 to 20	V
Low side supply voltage	V _{CC}	-0.3 to 20	V
All others	V _{I/O}	-0.3 to V _{CC}	V
Driver outputs (DC)	I _{OMAX(DC)}	±1.5* ²	A
Driver outputs (Pulse)	I _{OMAX(PLS)}	±2.5* ²	A
Fault signal output	I _{OMAX(FOB)}	15* ¹	mA
Power dissipation	P _d	3.00* ³	W
Thermal resistance	R _{thj-c}	15	°C/W
Operating case temperature	T _C	-20 to 100	°C
Storage temperature	T _{STG}	-55 to 150	°C
Junction temperature	T _{jmax}	150	°C

Note) All voltages are with respect to ground.

*1 Do not, however, exceed P_d or ASO.

*2 P_w ≤ 10μs, Duty cycle ≤ 1%

*3 Mounted on a 70mm x 70mm x 1.6mm FR4 glass-epoxy board with less than 3% copper foil. Derated at 24mW/°C above 25°C.

● Operating Conditions (T_C=25°C)

Parameter	Symbol	Range			Unit
		Min.	Typ.	Max.	
Supply voltage	V _{DC}	-	310	400	V
High side floating supply voltage	V _{BU} -V _U , V _{BV} -V _V , V _{BW} -V _W	13.5	15	16.5	V
Low side supply voltage	V _{CC}	13.5	15	16.5	V
Minimum input pulse width	T _{MIN}	0.8	-	-	μs
Dead time	T _{DT}	1.5	-	-	μs
Shunt resistor (PGND)	R _S	0.4	-	-	Ω
Junction temperature	T _j	-	-	125	°C

Note) All voltages are with respect to ground.

● **Electrical Characteristics** (Unless otherwise specified, Ta=25°C and VCC=15V)

Parameter	Symbol	Limits			Unit	Conditions
		Min.	Typ.	Max.		
Power supply						
HS quiescence current	I _{BBQ}	30	70	150	μA	XH=XL=L, each phase
LS quiescence current	I _{CCQ}	0.4	0.9	1.5	mA	XH=XL=L
Output MOSFET						
D-S breakdown voltage	V _{(BR)DSS}	600	-	-	V	I _D =1mA, XH=XL=L
Leak current	I _{DSS}	-	-	100	μA	V _{DS} =600V, XH=XL=L
DC on resistance	R _{DS(ON)}	-	2.7	3.5	Ω	I _D =0.75A
Diode forward voltage	V _{SD}	-	1.1	1.5	V	I _D =0.75A
Bootstrap diode						
Leak current	I _{LBD}	-	-	10	μA	V _{BX} =600V
Forward voltage	V _{FBD}	1.5	1.8	2.1	V	I _{BD} =-5mA, including series-R
Series resistance	R _{BD}	-	200	-	Ω	
Control inputs						
Input bias current	I _{XIN}	30	50	70	μA	V _{IN} =5V
Input high voltage	V _{XINH}	2.5	-	VCC	V	
Input low voltage	V _{XINL}	0	-	0.8	V	
Under voltage lock out						
HS release voltage	V _{BUVH}	9.5	10.0	10.5	V	V _{BX} - V _X
HS lockout voltage	V _{BUVL}	8.5	9.0	9.5	V	V _{BX} - V _X
LS release voltage	V _{CCUVH}	11.0	11.5	12.0	V	
LS lockout voltage	V _{CCUVL}	10.0	10.5	11.0	V	
Overcurrent protection						
Threshold voltage	V _{SNS}	0.8	0.9	1.0	V	
Fault output						
Output low voltage	V _{FOL}	-	-	0.8	V	I _O =+10mA
Input high voltage	V _{FINH}	2.5	-	VCC	V	
Input low voltage	V _{FINL}	0	-	0.8	V	
Noise masking time	T _{MASK}	2.0	-	-	μs	

● Typical Performance Curves (Reference data)

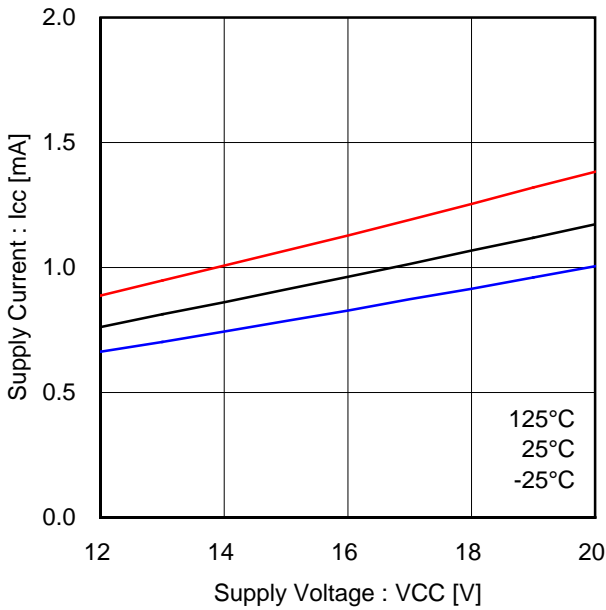

Figure 13. Quiescence current (Low side drivers)

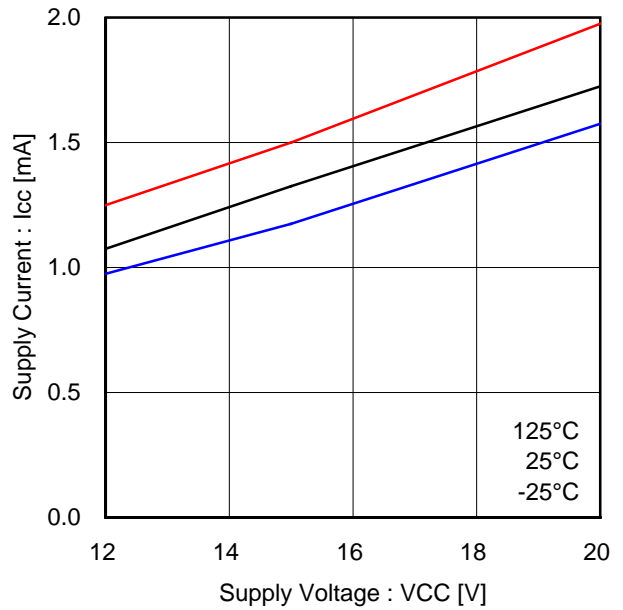

Figure 14. Low side drivers operating current (FPWM: 20kHz, one phase switching)

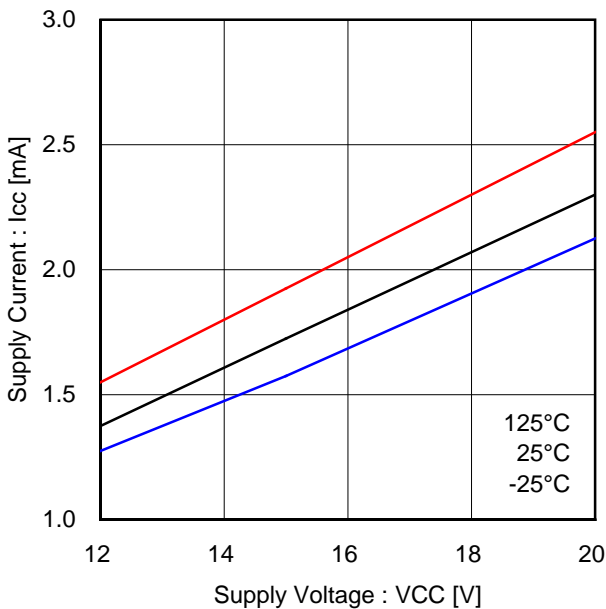

Figure 15. Low side drivers operating current (FPWM: 20kHz, two phase switching)

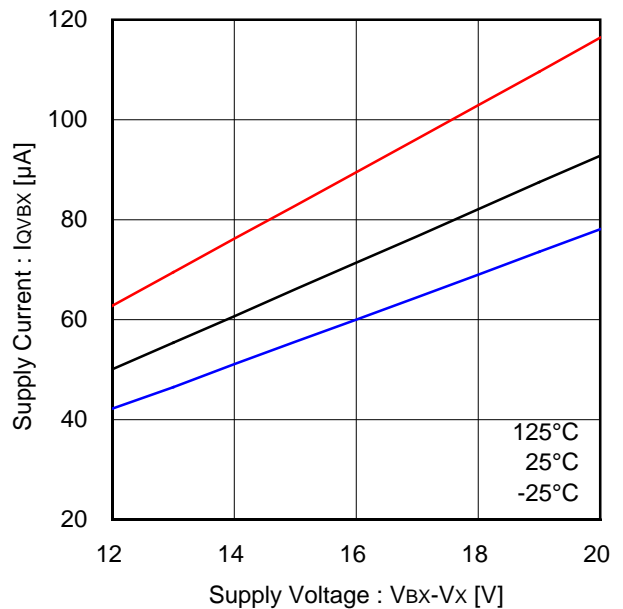

Figure 16. Quiescence current (High side driver, each phase)

● Typical Performance Curves (Reference data) - Continued

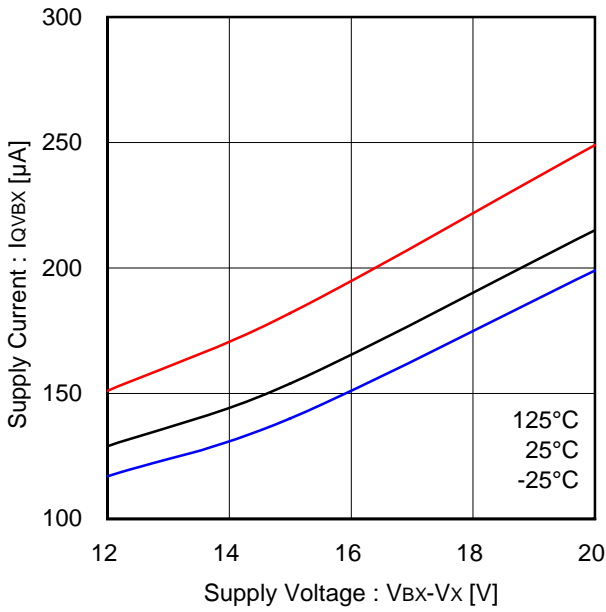

Figure 17. High side driver operating current (F_{PWM}: 20kHz, each phase)

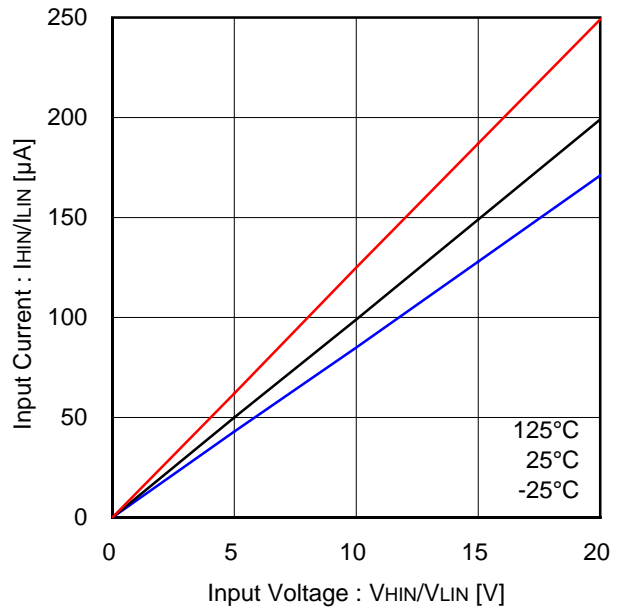

Figure 18. Input bias current (UH,UL,VH,VL,WH,WL)

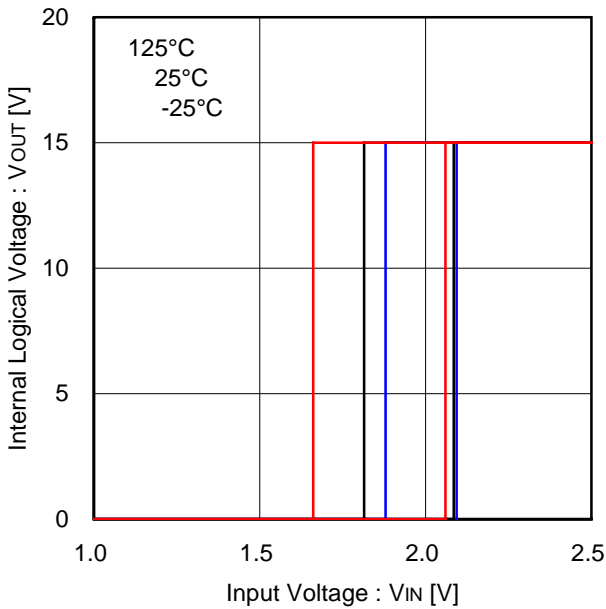

Figure 19. Input threshold voltage (UH,UL,VH,VL,WH,WL,FOB)

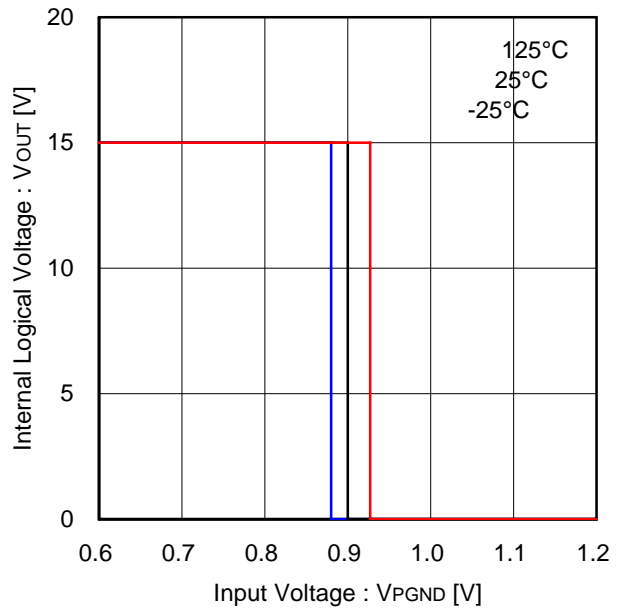

Figure 20. Overcurrent detection voltage

● Typical Performance Curves (Reference data) - Continued

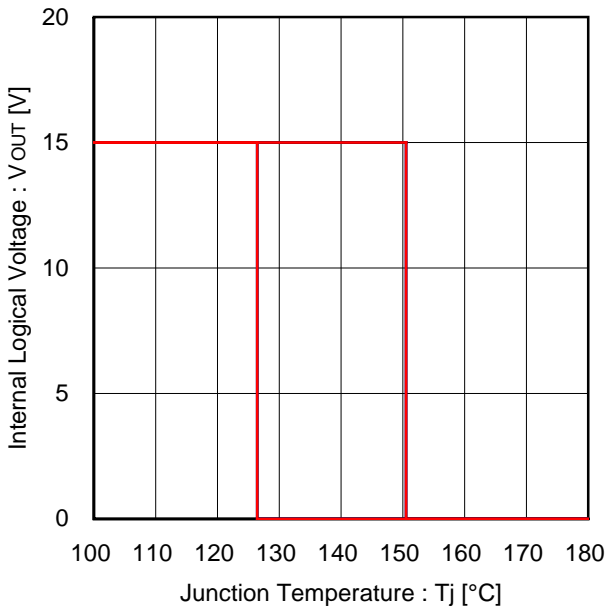

Figure 21. Thermal shut down

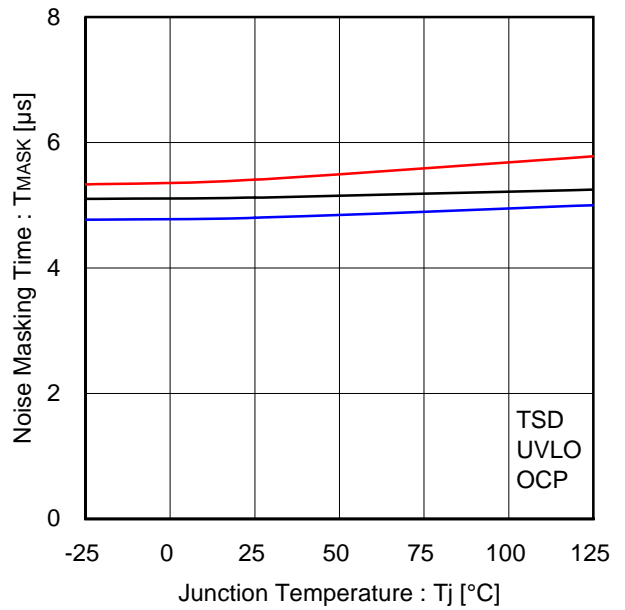

Figure 22. Noise masking time

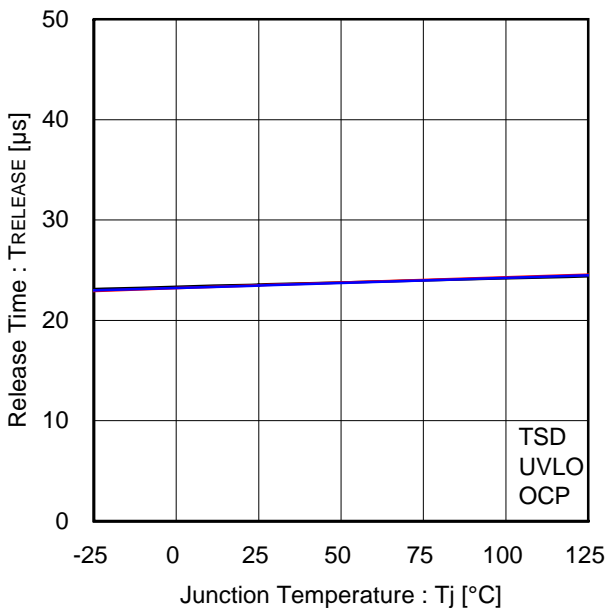

Figure 23. Release time
(No external capacitor)

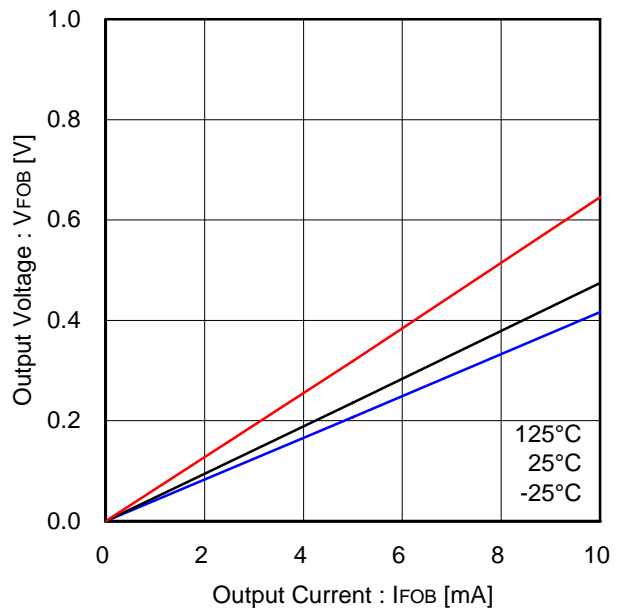

Figure 24. Fault output ON resistance

● Typical Performance Curves (Reference data) - Continued

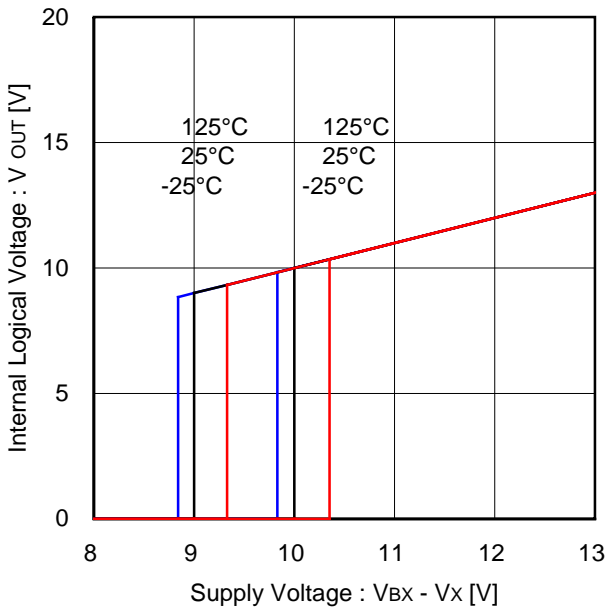

Figure 25. Under voltage lock out (High side driver, each phase)

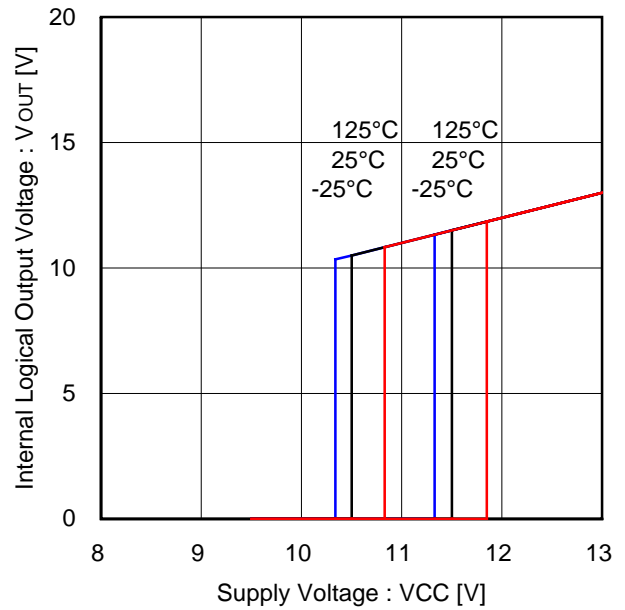

Figure 26. Under voltage lock out (Low side drivers)

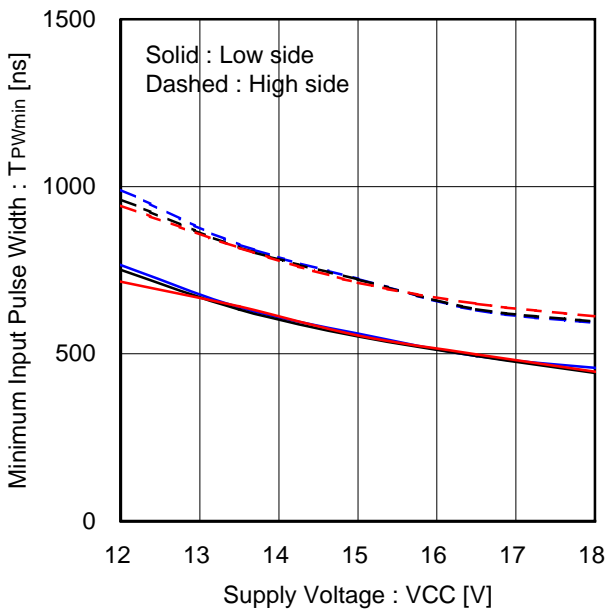

Figure 27. Minimum input pulse width

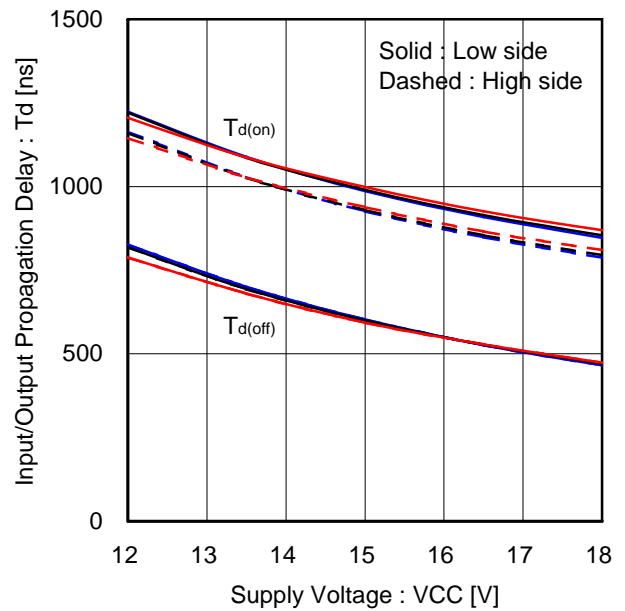

Figure 28. Input/Output propagation delay

● Typical Performance Curves (Reference data) - Continued

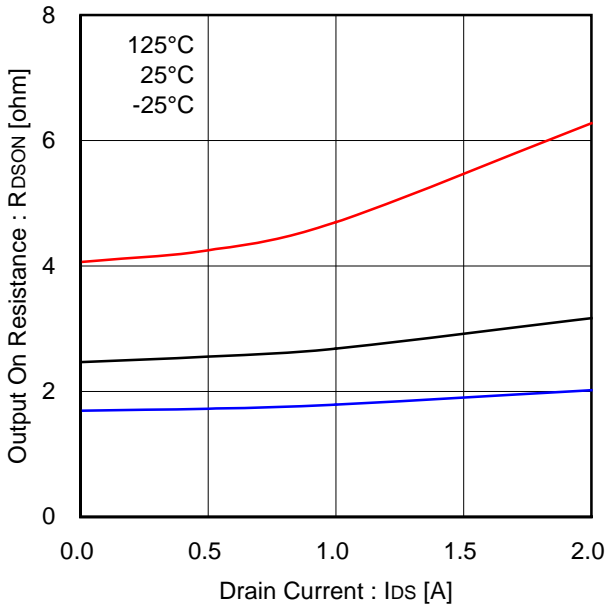

Figure 29. Output MOSFET ON resistance

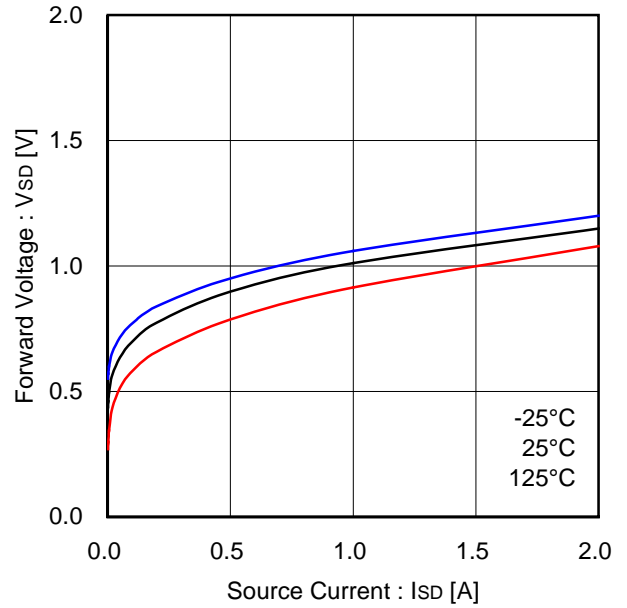

Figure 30. Output MOSFET body diode

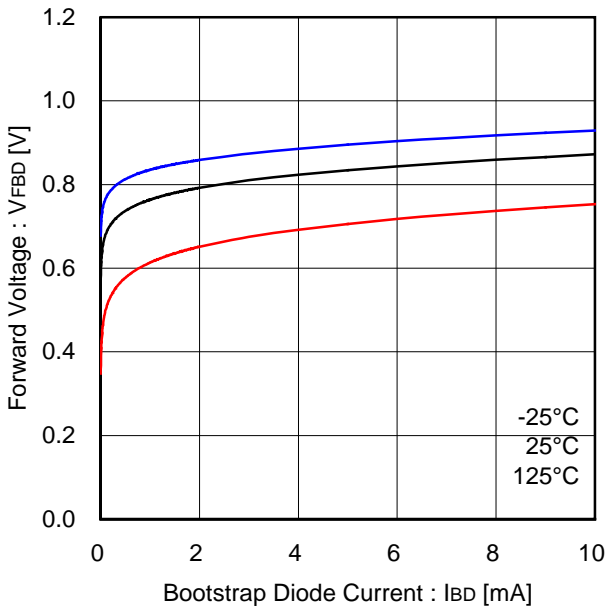

Figure 31. Bootstrap diode forward voltage

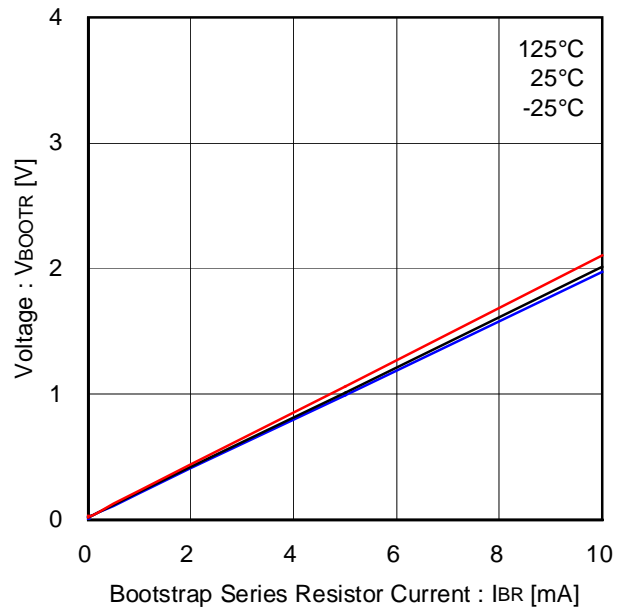

Figure 32. Bootstrap series resistor

● Typical Performance Curves (Reference data) - Continued

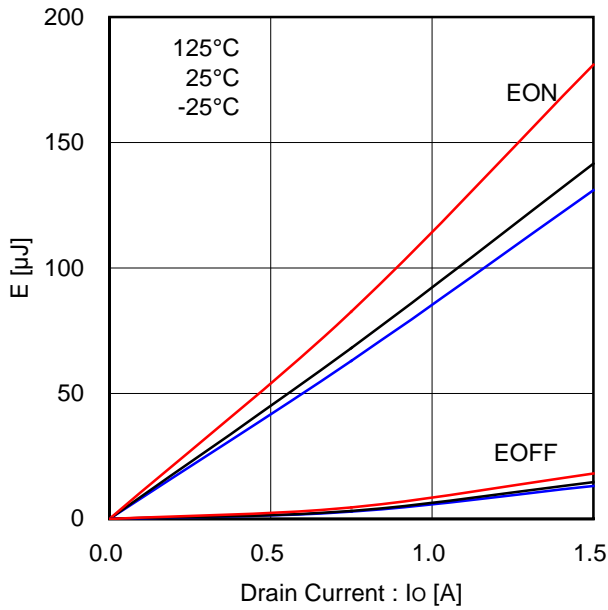

Figure 33. High side switching loss (VDC=300V)

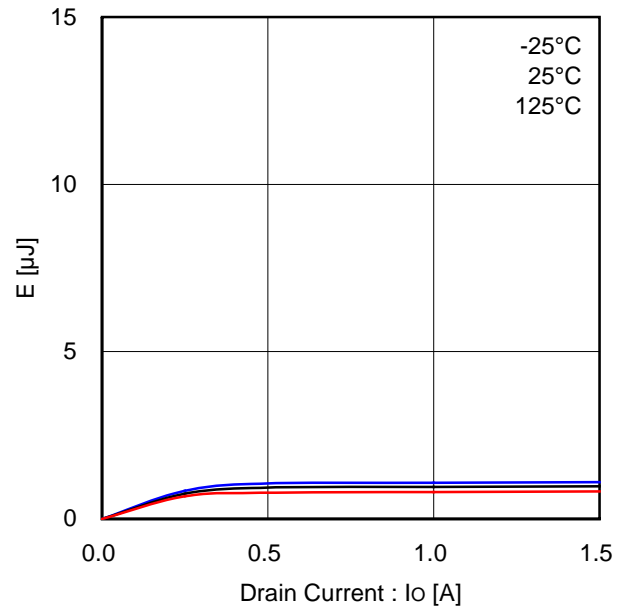

Figure 34. High side recovery loss (VDC=300V)

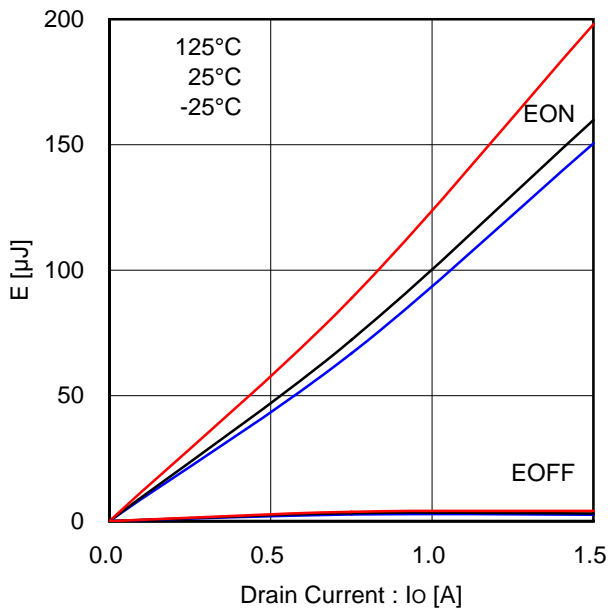

Figure 35. Low side switching loss (VDC=300V)

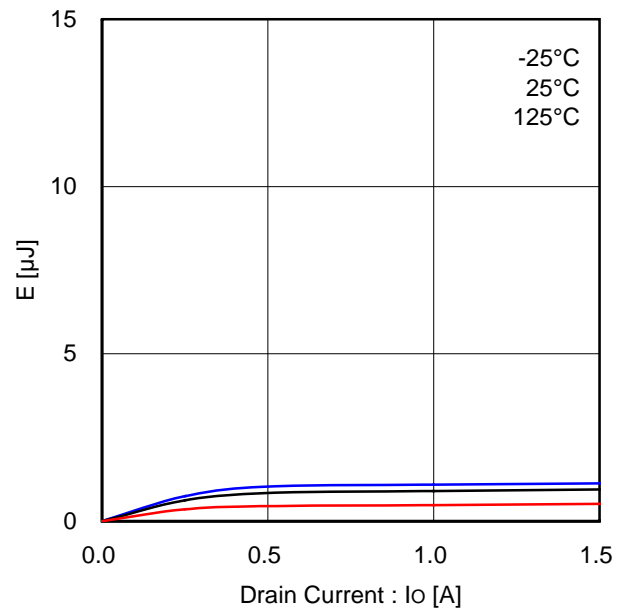

Figure 36. Low side recovery loss (VDC=300V)

● Application Circuit Example

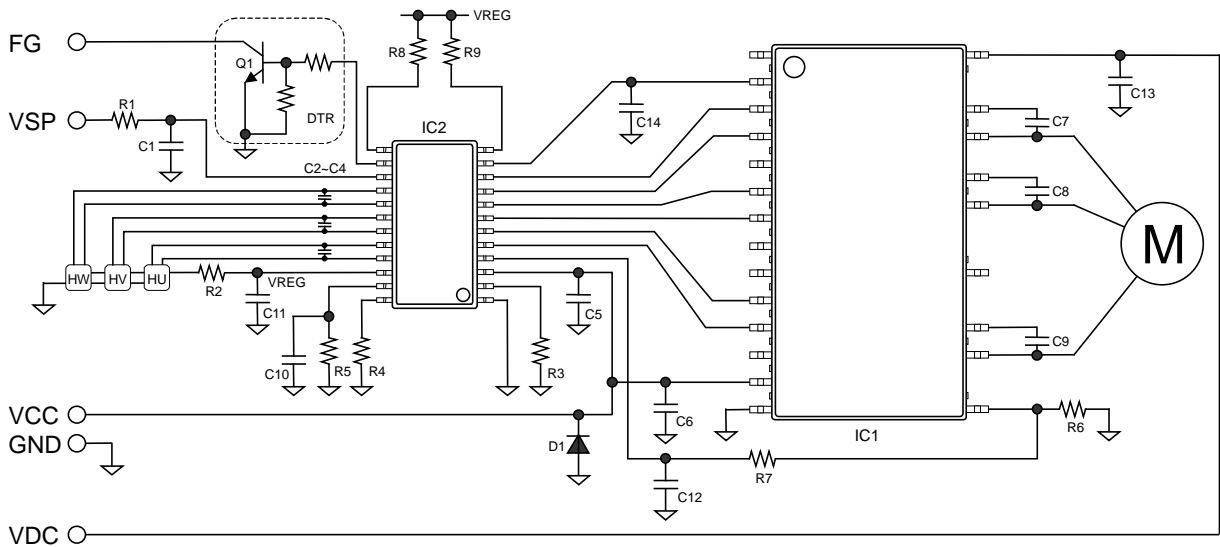

Figure 37. Application circuit example (150° commutation driver)

Parts list

Parts	Value	Manufacturer	Type	Parts	Value	Ratings	Type
IC1	-	ROHM	BM6202FS	C1	0.1μF	50V	Ceramic
IC2	-	ROHM	BD62012FS	C2-4	2200pF	50V	Ceramic
R1	1kΩ	ROHM	MCR18EZPF1001	C5	10 μF	50V	Ceramic
R2	150Ω	ROHM	MCR18EZPJ151	C6	10 μF	50V	Ceramic
R3	22kΩ	ROHM	MCR18EZPF2202	C7-9	1μF	50V	Ceramic
R4	100kΩ	ROHM	MCR18EZPF1003	C10	0.1μF	50V	Ceramic
R5	100kΩ	ROHM	MCR18EZPF1003	C11	1μF	50V	Ceramic
R6	0.5Ω	ROHM	MCR50JZHFL1R50 x 3	C12	100pF	50V	Ceramic
R7	10kΩ	ROHM	MCR18EZPF1002	C13	0.1μF	630V	Ceramic
R8	0Ω	ROHM	MCR18EZPJ000	C14	0.1μF	50V	Ceramic
R9	0Ω	ROHM	MCR18EZPJ000	HX	-	-	Hall elements
Q1	-	ROHM	DTC124EUA				
D1	-	ROHM	KDZ20B				

● Interfaces

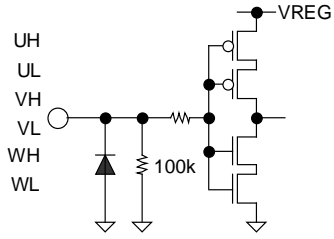

Figure 38. UH, UL, VH, VL, WH, WL

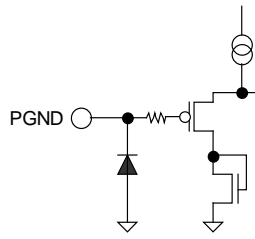

Figure 39. PGND

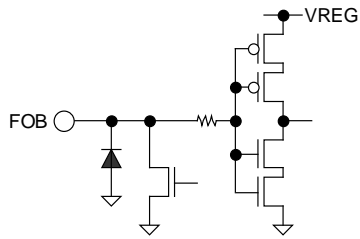

Figure 40. FOB

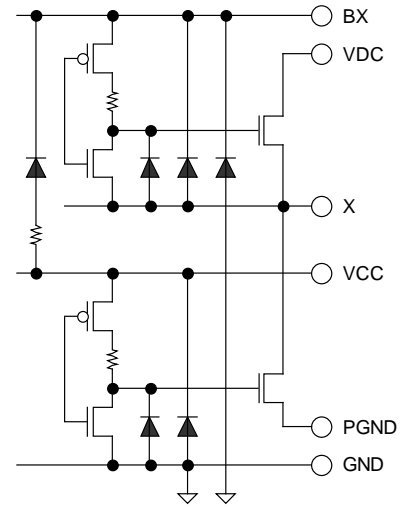

Figure 41. VCC, GND, VDC, BX(BU/BV/BW), X(U/V/W)

● Notes for Use**1) Absolute maximum ratings**

Devices may be destroyed when supply voltage or operating temperature exceeds the absolute maximum rating. Because the cause of this damage cannot be identified as, for example, a short circuit or an open circuit, it is important to consider circuit protection measures, such as adding fuses, if any value in excess of absolute maximum ratings is to be implemented.

2) Electrical potential at GND

Keep the GND terminal to the minimum potential under any operating condition. In addition, check to determine whether there is any terminal that provides voltage below GND, including the voltage during transient phenomena. However, note that even if the voltage does not fall below GND in any other operating condition, it can still swing below GND potential when the motor generates back electromotive force at the PGND pin. The chip layout in this product is designed to avoid this sort of electrical potential problem, but pulling excessive current may still result in malfunctions. Therefore, it is necessary to observe operation closely to conclusively confirm that there is no problem in actual operation. If there are a small signal GND and a high current GND, it is recommended to separate the patterns for the high current GND and the small signal GND and provide a proper grounding to the reference point of the set not to affect the voltage at the small signal GND with the change in voltage due to resistance component of pattern wiring and high current. Also for GND wiring pattern of the component externally connected, pay special attention not to cause undesirable change to it.

3) High voltage terminal – VDC, BU/U, BV/V and BW/W

When using this IC, the high voltage terminals VDC, BU/U, BV/V and BW/W need a resin coating between these pins. It is judged that the inter-pins distance is not enough. If any special mode in excess of absolute maximum ratings is to be implemented with this product or its application circuits, it is important to take physical safety measures, such as providing voltage-clamping diodes or fuses. And, set the output transistor so that it does not exceed absolute maximum ratings or ASO. In the event a large capacitor is connected between the output and ground, and if VCC and VDC are short-circuited with 0V or ground for any reason, the current charged in the capacitor flows into the output and may destroy the IC.

4) Power supply lines

Return current generated by the motor's Back-EMF requires countermeasures, such as providing a return current path by inserting capacitors across the power supply and GND (10 μ F, ceramic capacitor is recommended). In this case, it is important to conclusively confirm that none of the negative effects sometimes seen with electrolytic capacitors including a capacitance drop at low temperatures occurs. Also, the connected power supply must have sufficient current absorbing capability. Otherwise, the regenerated current will increase voltage on the power supply line, which may in turn cause problems with the product, including peripheral circuits exceeding the absolute maximum rating. To help protect against damage or degradation, physical safety measures should be taken, such as providing a voltage-clamping diode across the power supply and GND.

5) Thermal design

Use a thermal design that allows sufficient margin in light of the power dissipation (Pd) in actual operating conditions.

6) Inter-pin shorts and mounting errors

Take caution when positioning the IC for mounting on printed circuit boards. The IC may be damaged if there is any connection error or if pins are shorted together. Also, connecting the power supply in reverse polarity can damage the IC. Take precautions against reverse polarity when connecting the power supply lines, such as establishing an external diode between the power supply and the IC power supply pin.

7) Operation in strong electromagnetic fields

Using this product in strong electromagnetic fields may cause IC malfunctions. Take extreme caution with electromagnetic fields.

8) Testing on application boards

When testing the IC on an application board, connecting a capacitor to a low impedance pin subjects the IC to stress. Always discharge capacitors after each process or step. Always turn the IC's power supply off before connecting it to or removing it from a jig or fixture during the inspection process. Ground the IC during assembly steps as an antistatic measure. Use similar precaution when transporting or storing the IC.

9) Regarding the input pin of the IC

Do not force voltage to the input pins when the power does not supply to the IC. Also, do not force voltage to the input pins that exceed the supply voltage or in the guaranteed the absolute maximum rating value even if the power is supplied to the IC.

● Ordering Information

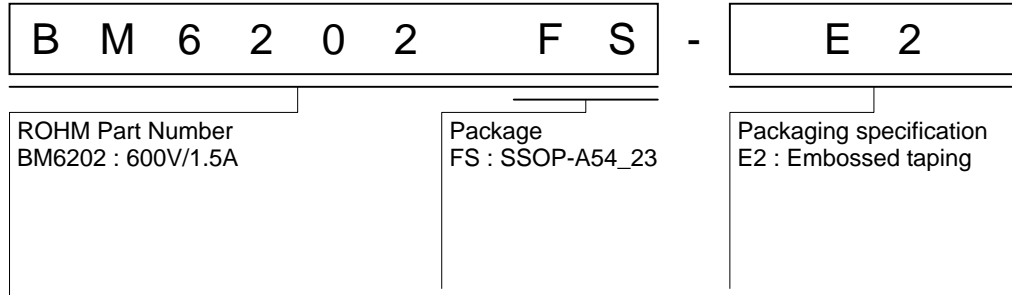

● Physical Dimension, Tape and Reel Information

SSOP-A54_23

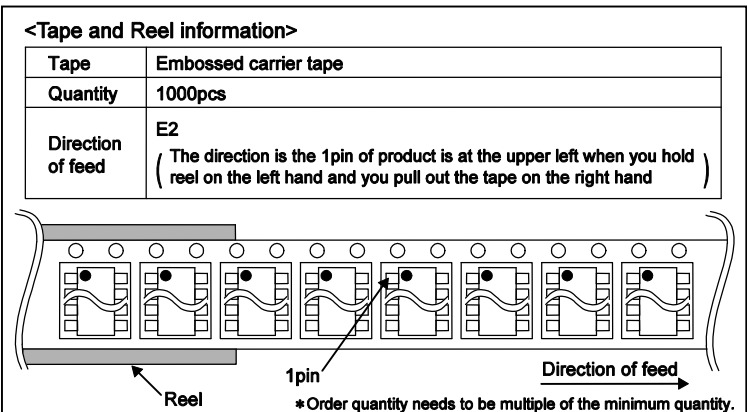
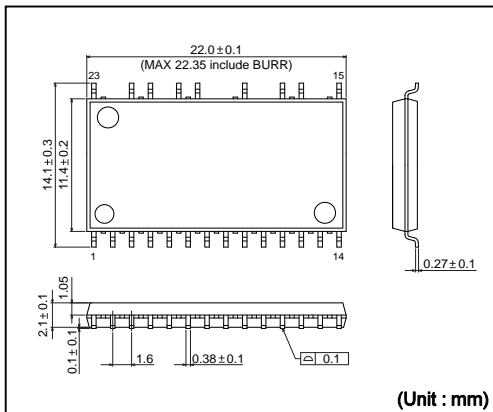

● Marking Diagram

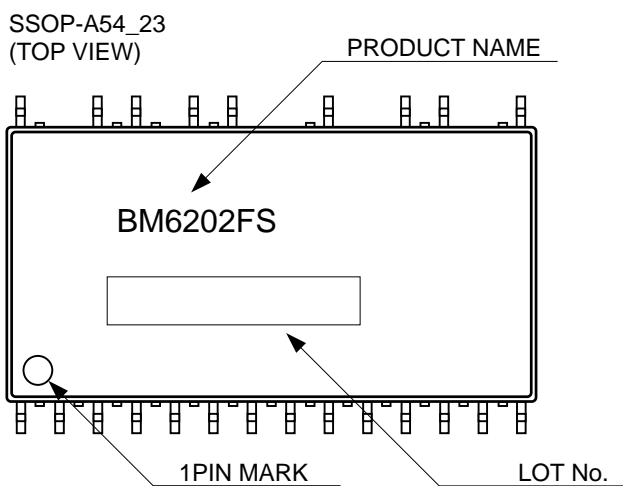

● Revision History

Date	Revision	Changes
22.FEB.2013	001	New release

Notice

Precaution on using ROHM Products

- Our Products are designed and manufactured for application in ordinary electronic equipments (such as AV equipment, OA equipment, telecommunication equipment, home electronic appliances, amusement equipment, etc.). If you intend to use our Products in devices requiring extremely high reliability (such as medical equipment ^(Note 1), transport equipment, traffic equipment, aircraft/spacecraft, nuclear power controllers, fuel controllers, car equipment including car accessories, safety devices, etc.) and whose malfunction or failure may cause loss of human life, bodily injury or serious damage to property ("Specific Applications"), please consult with the ROHM sales representative in advance. Unless otherwise agreed in writing by ROHM in advance, ROHM shall not be in any way responsible or liable for any damages, expenses or losses incurred by you or third parties arising from the use of any ROHM's Products for Specific Applications.

(Note1) Medical Equipment Classification of the Specific Applications

JAPAN	USA	EU	CHINA
CLASS III	CLASS III	CLASS II b	CLASS III
CLASS IV		CLASS III	

- ROHM designs and manufactures its Products subject to strict quality control system. However, semiconductor products can fail or malfunction at a certain rate. Please be sure to implement, at your own responsibilities, adequate safety measures including but not limited to fail-safe design against the physical injury, damage to any property, which a failure or malfunction of our Products may cause. The following are examples of safety measures:
 - Installation of protection circuits or other protective devices to improve system safety
 - Installation of redundant circuits to reduce the impact of single or multiple circuit failure
- Our Products are designed and manufactured for use under standard conditions and not under any special or extraordinary environments or conditions, as exemplified below. Accordingly, ROHM shall not be in any way responsible or liable for any damages, expenses or losses arising from the use of any ROHM's Products under any special or extraordinary environments or conditions. If you intend to use our Products under any special or extraordinary environments or conditions (as exemplified below), your independent verification and confirmation of product performance, reliability, etc. prior to use, must be necessary:
 - Use of our Products in any types of liquid, including water, oils, chemicals, and organic solvents
 - Use of our Products outdoors or in places where the Products are exposed to direct sunlight or dust
 - Use of our Products in places where the Products are exposed to sea wind or corrosive gases, including Cl₂, H₂S, NH₃, SO₂, and NO₂
 - Use of our Products in places where the Products are exposed to static electricity or electromagnetic waves
 - Use of our Products in proximity to heat-producing components, plastic cords, or other flammable items
 - Sealing or coating our Products with resin or other coating materials
 - Use of our Products without cleaning residue of flux (even if you use no-clean type fluxes, cleaning residue of flux is recommended); or Washing our Products by using water or water-soluble cleaning agents for cleaning residue after soldering
 - Use of the Products in places subject to dew condensation
- The Products are not subject to radiation-proof design.
- Please verify and confirm characteristics of the final or mounted products in using the Products.
- In particular, if a transient load (a large amount of load applied in a short period of time, such as pulse. is applied, confirmation of performance characteristics after on-board mounting is strongly recommended. Avoid applying power exceeding normal rated power; exceeding the power rating under steady-state loading condition may negatively affect product performance and reliability.
- De-rate Power Dissipation (Pd) depending on Ambient temperature (Ta). When used in sealed area, confirm the actual ambient temperature.
- Confirm that operation temperature is within the specified range described in the product specification.
- ROHM shall not be in any way responsible or liable for failure induced under deviant condition from what is defined in this document.

Precaution for Mounting / Circuit board design

- When a highly active halogenous (chlorine, bromine, etc.) flux is used, the residue of flux may negatively affect product performance and reliability.
- In principle, the reflow soldering method must be used; if flow soldering method is preferred, please consult with the ROHM representative in advance.

For details, please refer to ROHM Mounting specification

Precautions Regarding Application Examples and External Circuits

1. If change is made to the constant of an external circuit, please allow a sufficient margin considering variations of the characteristics of the Products and external components, including transient characteristics, as well as static characteristics.
2. You agree that application notes, reference designs, and associated data and information contained in this document are presented only as guidance for Products use. Therefore, in case you use such information, you are solely responsible for it and you must exercise your own independent verification and judgment in the use of such information contained in this document. ROHM shall not be in any way responsible or liable for any damages, expenses or losses incurred by you or third parties arising from the use of such information.

Precaution for Electrostatic

This Product is electrostatic sensitive product, which may be damaged due to electrostatic discharge. Please take proper caution in your manufacturing process and storage so that voltage exceeding the Products maximum rating will not be applied to Products. Please take special care under dry condition (e.g. Grounding of human body / equipment / solder iron, isolation from charged objects, setting of Ionizer, friction prevention and temperature / humidity control).

Precaution for Storage / Transportation

1. Product performance and soldered connections may deteriorate if the Products are stored in the places where:
 - [a] the Products are exposed to sea winds or corrosive gases, including Cl₂, H₂S, NH₃, SO₂, and NO₂
 - [b] the temperature or humidity exceeds those recommended by ROHM
 - [c] the Products are exposed to direct sunshine or condensation
 - [d] the Products are exposed to high Electrostatic
2. Even under ROHM recommended storage condition, solderability of products out of recommended storage time period may be degraded. It is strongly recommended to confirm solderability before using Products of which storage time is exceeding the recommended storage time period.
3. Store / transport cartons in the correct direction, which is indicated on a carton with a symbol. Otherwise bent leads may occur due to excessive stress applied when dropping of a carton.
4. Use Products within the specified time after opening a humidity barrier bag. Baking is required before using Products of which storage time is exceeding the recommended storage time period.

Precaution for Product Label

QR code printed on ROHM Products label is for ROHM's internal use only.

Precaution for Disposition

When disposing Products please dispose them properly using an authorized industry waste company.

Precaution for Foreign Exchange and Foreign Trade act

Since our Products might fall under controlled goods prescribed by the applicable foreign exchange and foreign trade act, please consult with ROHM representative in case of export.

Precaution Regarding Intellectual Property Rights

1. All information and data including but not limited to application example contained in this document is for reference only. ROHM does not warrant that foregoing information or data will not infringe any intellectual property rights or any other rights of any third party regarding such information or data. ROHM shall not be in any way responsible or liable for infringement of any intellectual property rights or other damages arising from use of such information or data.:
2. No license, expressly or implied, is granted hereby under any intellectual property rights or other rights of ROHM or any third parties with respect to the information contained in this document.

Other Precaution

1. This document may not be reprinted or reproduced, in whole or in part, without prior written consent of ROHM.
2. The Products may not be disassembled, converted, modified, reproduced or otherwise changed without prior written consent of ROHM.
3. In no event shall you use in any way whatsoever the Products and the related technical information contained in the Products or this document for any military purposes, including but not limited to, the development of mass-destruction weapons.
4. The proper names of companies or products described in this document are trademarks or registered trademarks of ROHM, its affiliated companies or third parties.

General Precaution

1. Before you use our Products, you are requested to carefully read this document and fully understand its contents. ROHM shall not be in any way responsible or liable for failure, malfunction or accident arising from the use of any ROHM's Products against warning, caution or note contained in this document.
2. All information contained in this document is current as of the issuing date and subject to change without any prior notice. Before purchasing or using ROHM's Products, please confirm the latest information with a ROHM sales representative.
3. The information contained in this document is provided on an "as is" basis and ROHM does not warrant that all information contained in this document is accurate and/or error-free. ROHM shall not be in any way responsible or liable for any damages, expenses or losses incurred by you or third parties resulting from inaccuracy or errors of or concerning such information.

Компания «Life Electronics» занимается поставками электронных компонентов импортного и отечественного производства от производителей и со складов крупных дистрибьюторов Европы, Америки и Азии.

С конца 2013 года компания активно расширяет линейку поставок компонентов по направлению коаксиальный кабель, кварцевые генераторы и конденсаторы (керамические, пленочные, электролитические), за счёт заключения дистрибьюторских договоров

Мы предлагаем:

- Конкурентоспособные цены и скидки постоянным клиентам.
- Специальные условия для постоянных клиентов.
- Подбор аналогов.
- Поставку компонентов в любых объемах, удовлетворяющих вашим потребностям.
- Приемлемые сроки поставки, возможна ускоренная поставка.
- Доставку товара в любую точку России и стран СНГ.
- Комплексную поставку.
- Работу по проектам и поставку образцов.
- Формирование склада под заказчика.
- Сертификаты соответствия на поставляемую продукцию (по желанию клиента).
- Тестирование поставляемой продукции.
- Поставку компонентов, требующих военную и космическую приемку.
- Входной контроль качества.
- Наличие сертификата ISO.

В составе нашей компании организован Конструкторский отдел, призванный помогать разработчикам, и инженерам.

Конструкторский отдел помогает осуществить:

- Регистрацию проекта у производителя компонентов.
- Техническую поддержку проекта.
- Защиту от снятия компонента с производства.
- Оценку стоимости проекта по компонентам.
- Изготовление тестовой платы монтаж и пусконаладочные работы.



Тел: +7 (812) 336 43 04 (многоканальный)

Email: org@lifeelectronics.ru