

Fork terminals allow connection without solder



Detector

Slide

Push

Rotary

Power

Dual-in-line
Package Type

General-
purpose Type

Water-proof
Type

Fast Switching
Type

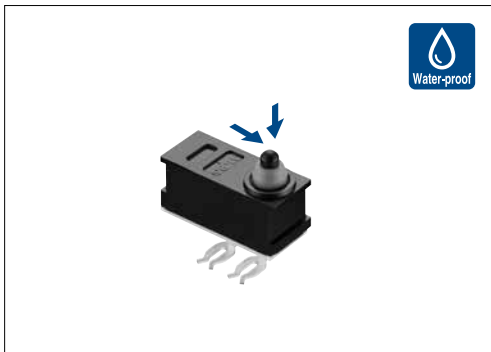

Typical Specifications

Items		Specifications
Rating (max.)/(min.) (Resistive load)		0.1A 12V DC / 50μA 5V DC
Contact resistance (Initial / After operating life)		500mΩ max. / 1Ω max.
Operating force		1±0.5N
Operating life	Without load	300,000cycles
	With load	300,000cycles (0.1A 12V DC)

Product Line

Poles	Positions	Change over timing	Operating part shape	Terminal type	Main body form	Minimum order unit (pcs)		Product No.	Drawing No.		
						Japan	Export				
1	1	Non shorting	Push	Press fit (Without terminal No.3)	Without boss L type	1,200	4,800	SPVQA10103	1		
					Without boss R type			SPVQA10203	2		
				Press fit (Without terminal No.2)	Without boss L type			SPVQA10302	3		
					Without boss R type			SPVQA10402	4		
	Press fit			Without boss L type	SPVQA10504			5			
				Without boss R type	SPVQA10604			6			
	1			2	For PC board (Without terminal No.3)			Without boss		SPVQA20103	7
									For PC board	SPVQA20203	8

Note

This unit cannot be used in water (IP67 rating, except for terminal).

Packing Specifications

Number of packages (pcs.)		Export package measurements (mm)
1 case /Japan	1 case /export packing	
1,200	4,800	540×360×270

Dimensions

No.	Style	No.	Style
1		2	

Unit:mm

■ Dimensions

Unit:mm

No.	Style	No.	Style
3		6	
4		7	
5		8	

■ Circuit Diagram

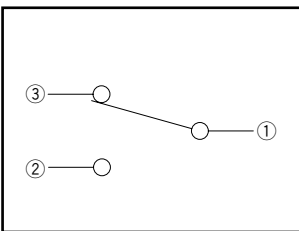

Detector

Slide

Push

Rotary

Power

Dual-in-line
Package Type

General-
purpose Type

Water-proof
Type

Fast Switching
Type

Detector

Slide

Push

Rotary

Power

Dual-in-line
Package
Type

General-
purpose
Type

Waterproof
Type

Fast Switching
Type









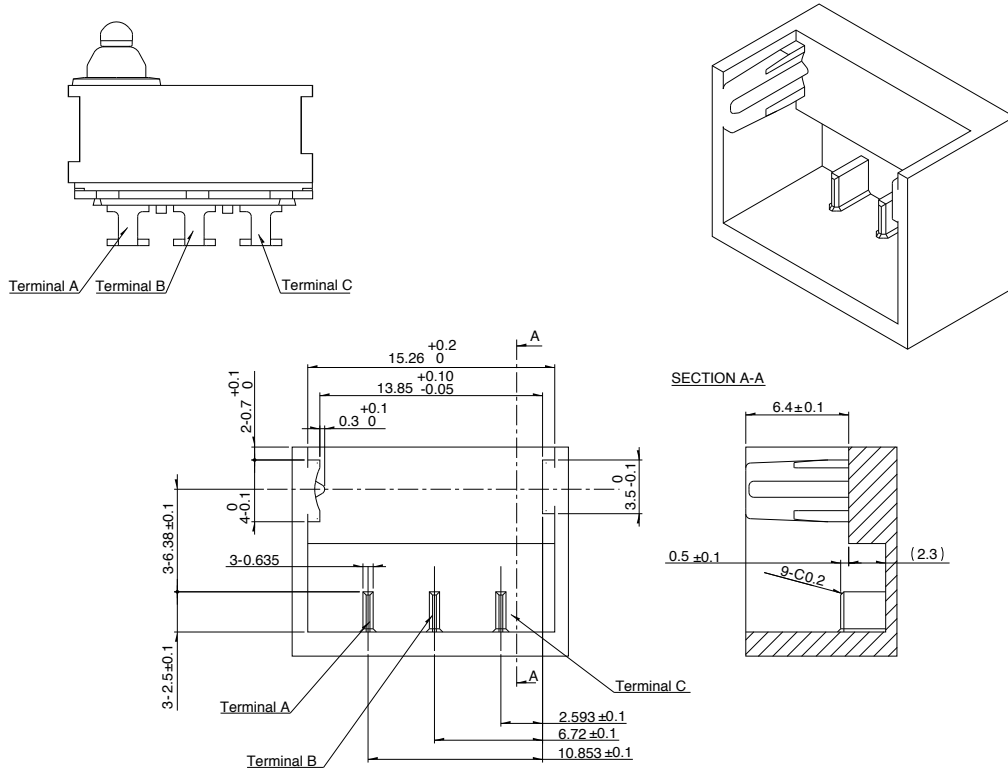

Reference Drawing for Unit Terminals

Unit:mm

Style

SPVQA10504



Series		Water-proof Type			Fast Switching Type	
		SPVQ8	SPVQA	SSCN	SPVQ9	SPVQC
Photo						
Operation type		Two-way				
Dimensions (mm)	W	8.3	15.2	13	15.4	15.4
	D	5.3	6.4	5	8.4	7.4
	H	6.5	7.95	15	7.5	
Operating temperature range		-40°C to +85°C				
Automotive use		●	●	●	●	●
Life cycle (availability)						
Poles / Positions		1/1	1/1 1/2	1/2	2/2	
Rating (max.) (Resistive load)		0.1A 12V DC			50mA 26V DC	50mA 18V DC
Rating (min.) (Resistive load)		50μA 5V DC		100μA 5V DC	50μA 5V DC	
Durability	Operating life without load	300,000cycles 1Ω max. or 1,000,000cycles 3Ω max.	300,000cycles 1Ω max.	100,000cycles 1Ω max.	300,000cycles 200mΩ max.	—
	Operating life with load Rating (max.) (Resistive load)	300,000cycles 1Ω max. or 1,000,000cycles 3Ω max.	300,000cycles 1Ω max.	100,000cycles 1Ω max.	300,000cycles 200mΩ max.	
Electrical performance	Initial contact resistance	500mΩ max.			75mΩ max.	
	Insulation resistance	100MΩ min. 500V DC				100MΩ min. 250V DC
	Voltage proof	500V AC for 1minute				250V AC for 1minute
Mechanical performance	Terminal strength	3N for 1minute (with terminal) Wire strength 30N for 1minute (with wire)	3N for 1minute			
	Actuator strength	20N		10N	20N	
Environmental performance	Cold	-40°C 500h				
	Dry heat	85°C 500h				
	Damp heat	60°C, 90 to 95% RH 500h				
Operation force		1±0.5N		2N max.	1±0.5N	
Page		55	60	63	64	65

Detector Switches Soldering Conditions 66
 Detector Switches Cautions 67

Note
 ● Indicates applicability to all products in the series.

Example of Reflow Soldering Condition

1. Heating method: Double heating method with infrared heater.
2. Temperature measurement: Thermocouple $\phi 0.1$ to 0.2 CA (K) or CC (T) at soldering portion (copper foil surface). A heat resisting tape should be used for fixed measurement.
3. Temperature profile



Series (Reflow type)	A (°C) 3s max.	B (°C)	C (s)	D (°C)	E (°C)	F (s)
SPPB	250	230	40	180	150	120
SPVE	260		40			
SPVL						
SPVM						
SPVN						
SPVR						
SPVS						
SPVT						
SSCM						
SSCQ						
SPVQC	250					

Notes

1. The condition mentioned above is the temperature on the mounting surface of a PC board. There are cases where the PC board's temperature greatly differs from that of the switch, surface depending on the PC board's material, size, thickness, etc. The above-stated conditions shall also apply to switch surface temperatures.
2. Soldering conditions differ depending on reflow soldering machines. Prior verification of soldering condition is highly recommended.

Reference for Hand Soldering

Series	Soldering temperature	Soldering time
SPVS, SPVN, SPVT, SPVM, SPVR, SPVE, SSCQ, SSCM, SPVL, SSCT, SPVQC	350±5°C	3s max.
SPVQ1, SPVQ3, SPVQ6, SPVQ7, SPVQ8, SPVQ9, SSCN, SPVQA	300±10°C	3 + 1 / 0s
SPPB (Reflow)	300±5°C	5s max.
SSCF, SPPB (For Lead, Dip)	350±10°C	3 + 1 / 0s

Reference for Dip Soldering (For PC board terminal types)

Series	Items		Dip soldering	
	Preheating temperature	Preheating time	Soldering temperature	Duration of immersion
SSCT, SPVQ1, SPVQ3, SPVQ6, SPVQ7, SPVQ8, SPVQ9, SPVQA	100±10°C	60s max.	260±5°C	5±1s
SPPW8, SPPB	100°C max.	60s max.	255±5°C	5±1s
SSCF	—		260±5°C	5±1s

Компания «Life Electronics» занимается поставками электронных компонентов импортного и отечественного производства от производителей и со складов крупных дистрибьюторов Европы, Америки и Азии.

С конца 2013 года компания активно расширяет линейку поставок компонентов по направлению коаксиальный кабель, кварцевые генераторы и конденсаторы (керамические, пленочные, электролитические), за счёт заключения дистрибьюторских договоров

Мы предлагаем:

- Конкурентоспособные цены и скидки постоянным клиентам.
- Специальные условия для постоянных клиентов.
- Подбор аналогов.
- Поставку компонентов в любых объемах, удовлетворяющих вашим потребностям.
- Приемлемые сроки поставки, возможна ускоренная поставка.
- Доставку товара в любую точку России и стран СНГ.
- Комплексную поставку.
- Работу по проектам и поставку образцов.
- Формирование склада под заказчика.
- Сертификаты соответствия на поставляемую продукцию (по желанию клиента).
- Тестирование поставляемой продукции.
- Поставку компонентов, требующих военную и космическую приемку.
- Входной контроль качества.
- Наличие сертификата ISO.

В составе нашей компании организован Конструкторский отдел, призванный помогать разработчикам, и инженерам.

Конструкторский отдел помогает осуществить:

- Регистрацию проекта у производителя компонентов.
- Техническую поддержку проекта.
- Защиту от снятия компонента с производства.
- Оценку стоимости проекта по компонентам.
- Изготовление тестовой платы монтаж и пусконаладочные работы.



Тел: +7 (812) 336 43 04 (многоканальный)
Email: org@lifeelectronics.ru