

Analog Devices Welcomes Hittite Microwave Corporation

NO CONTENT ON THE ATTACHED DOCUMENT HAS CHANGED



THIS PAGE INTENTIONALLY LEFT BLANK



GaAs InGaP HBT MMIC BROADBAND AMPLIFIER GAIN BLOCK, DC - 6 GHz

Typical Applications

Ideal as a Driver & Amplifier for:

- 2.2 - 2.7 GHz MMDS
- 3.5 GHz Wireless Local Loop
- 5 - 6 GHz UNII & HiperLAN

Features

- P1dB Output Power: +14 dBm
- Output IP3: +27 dBm
- Gain: 17 dB
- Single Supply: +5V
- High Reliability GaAs HBT Process
- Ultra Small Package: SOT26
- Included in the HMC-DK001 Designer's Kit

Functional Diagram

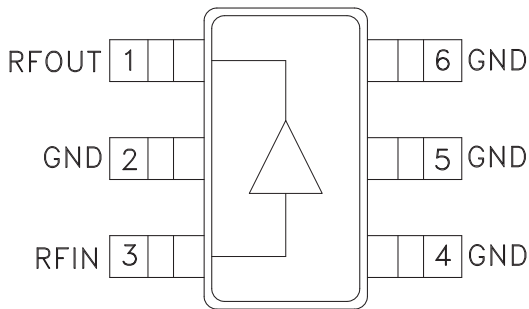

General Description

The HMC313 & HMC313E are GaAs InGaP Heterojunction Bipolar Transistor (HBT) MMIC amplifiers that operate from a single Vcc supply. The surface mount SOT26 amplifier can be used as a broadband gain stage or used with external matching for optimized narrow band applications. With Vcc biased at +5V, the HMC313(E) offers 17 dB of gain and +15 dBm of saturated power while only requiring 50 mA of current.

Electrical Specifications, $T_A = +25^\circ\text{C}$, $V_{CC} = +5.0V$

Parameter	Vcc = +5V			Units
	Min.	Typ.	Max.	
Frequency Range	DC - 6			GHz
Gain	14	17	20	dB
Gain Variation Over Temperature		0.02	0.03	dB/°C
Input Return Loss		7		dB
Output Return Loss		6		dB
Reverse Isolation		30		dB
Output Power for 1 dB Compression (P1dB) @ 1.0 GHz	11	14		dBm
Saturated Output Power (Psat) @ 1.0 GHz		15		dBm
Output Third Order Intercept (IP3) @ 1.0 GHz	24	27		dBm
Noise Figure		6.5		dB
Supply Current (Icc)		50		mA

Note: Data taken with broadband bias tee on device output.

For price, delivery, and to place orders, please contact Hittite Microwave Corporation:
 20 Alpha Road, Chelmsford, MA 01824 Phone: 978-250-3343 Fax: 978-250-3373
 Order On-line at www.hittite.com

GaAs InGaP HBT MMIC BROADBAND AMPLIFIER GAIN BLOCK, DC - 6 GHz

Gain & Return Loss

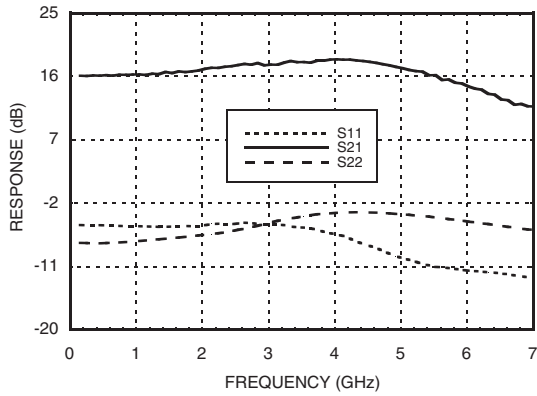

Gain vs. Temperature

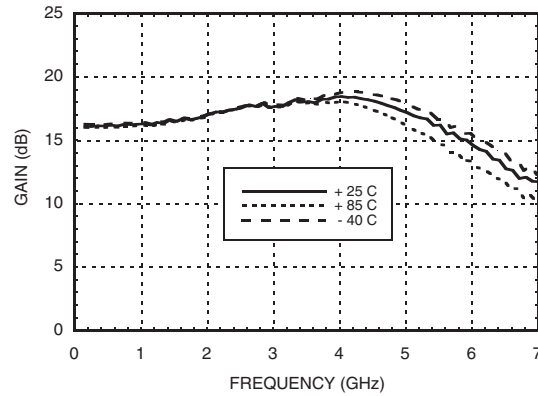

Input & Output Return Loss

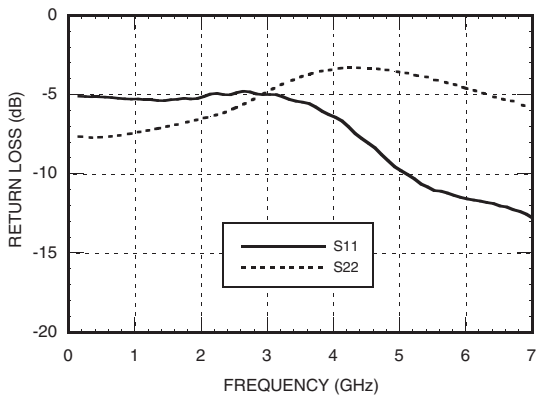

Reverse Isolation

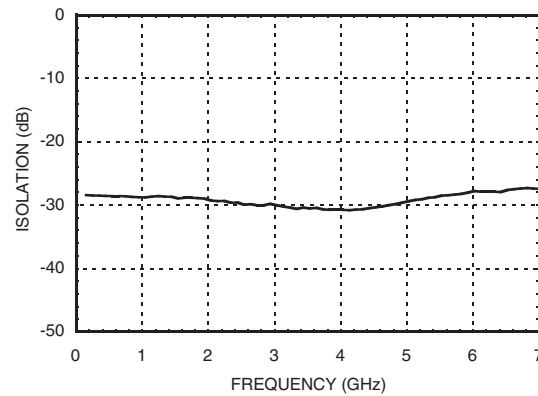

P1dB vs. Temperature

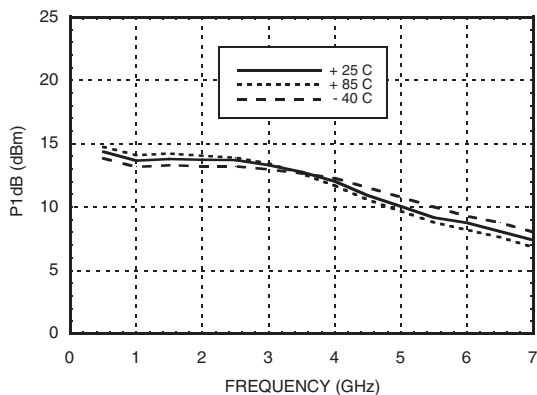

Psat vs. Temperature

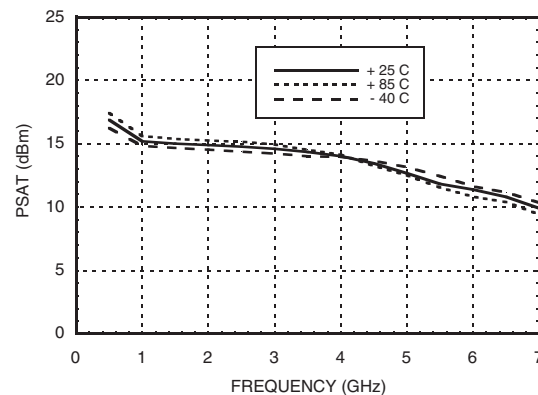



GaAs InGaP HBT MMIC BROADBAND AMPLIFIER GAIN BLOCK, DC - 6 GHz

Output IP3 vs. Temperature

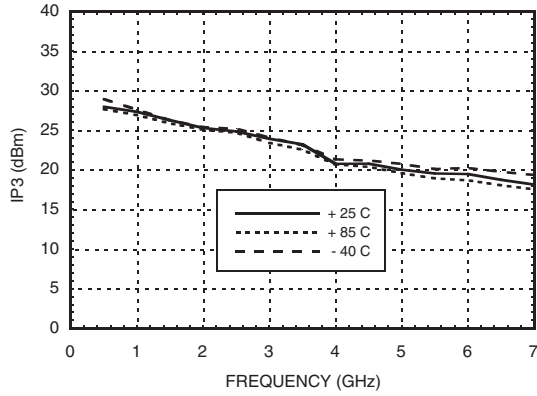

Power Compression @ 1 GHz

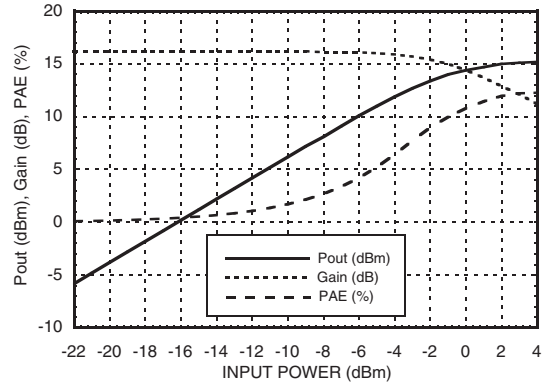

Power Compression @ 3 GHz

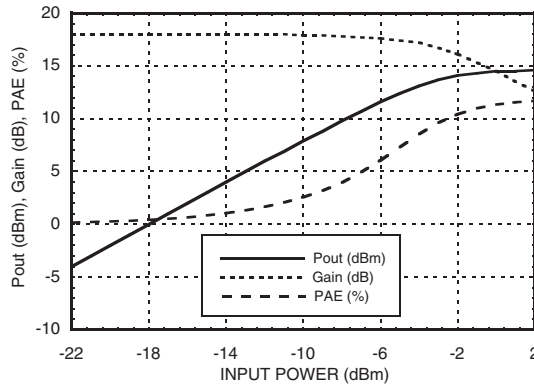

GaAs InGaP HBT MMIC BROADBAND AMPLIFIER GAIN BLOCK, DC - 6 GHz

Absolute Maximum Ratings

Collector Bias Voltage (Vcc)	+5.5 Vdc
RF Input Power (RFIN)(Vcc = +5Vdc)	+20 dBm
Junction Temperature	150 °C
Continuous P _{diss} (T = 85 °C) (derate 3.99 mW/°C above 85 °C)	0.259 W
Thermal Resistance (junction to lead)	251 °C/W
Storage Temperature	-65 to +150 °C
Operating Temperature	-40 to +85 °C
ESD Sensitivity (HBM)	Class 1A



ELECTROSTATIC SENSITIVE DEVICE
OBSERVE HANDLING PRECAUTIONS

Outline Drawing

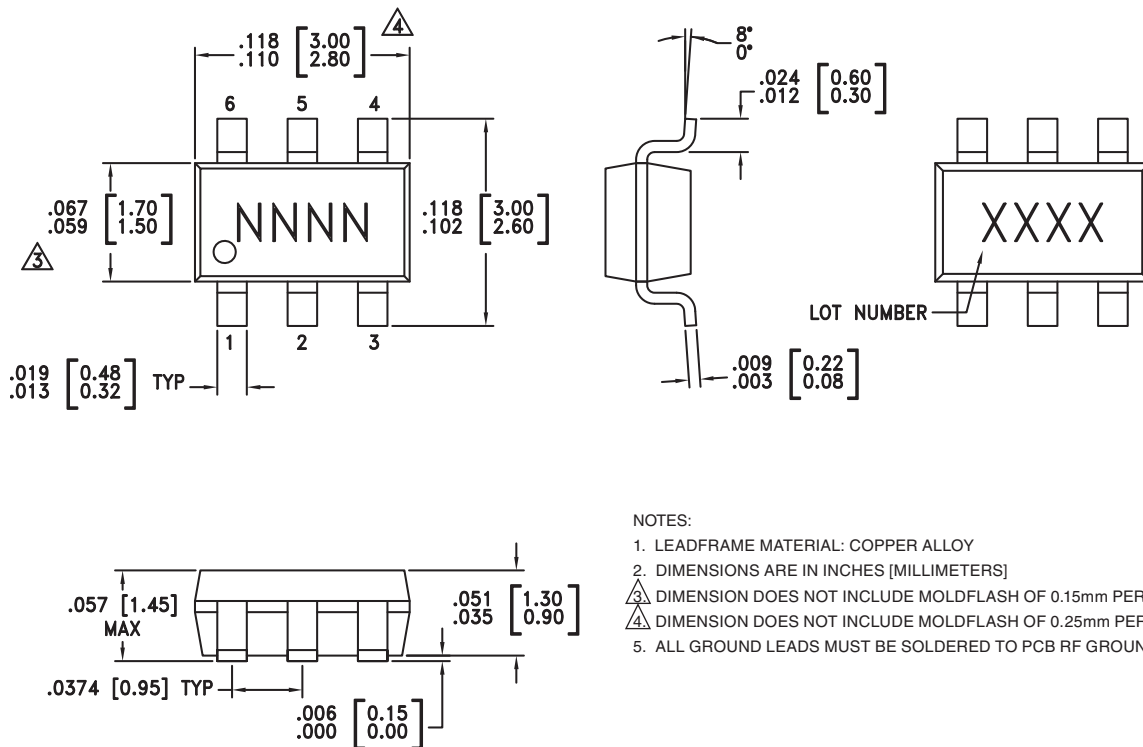

NOTES:

1. LEADFRAME MATERIAL: COPPER ALLOY
2. DIMENSIONS ARE IN INCHES [MILLIMETERS]
- △ DIMENSION DOES NOT INCLUDE MOLDFLASH OF 0.15mm PER SIDE.
- ▲ DIMENSION DOES NOT INCLUDE MOLDFLASH OF 0.25mm PER SIDE.
5. ALL GROUND LEADS MUST BE SOLDERED TO PCB RF GROUND

Package Information

Part Number	Package Body Material	Lead Finish	MSL Rating	Package Marking ^[3]
HMC313	Low Stress Injection Molded Plastic	Sn/Pb Solder	MSL1 ^[1]	H313 XXXX
HMC313E	RoHS-compliant Low Stress Injection Molded Plastic	100% matte Sn	MSL1 ^[2]	313E XXXX

[1] Max peak reflow temperature of 235 °C

[2] Max peak reflow temperature of 260 °C

[3] 4-Digit lot number XXXX

For price, delivery, and to place orders, please contact Hittite Microwave Corporation:
20 Alpha Road, Chelmsford, MA 01824 Phone: 978-250-3343 Fax: 978-250-3373
Order On-line at www.hittite.com

Pin Descriptions

Pin Number	Function	Description	Interface Schematic
1	RFOUT	This pin is DC coupled. An off chip DC blocking capacitor is required.	
3	RFIN	This pin is DC coupled. An off chip DC blocking capacitor is required.	
2, 4-6	GND	These pins must be connected to RF/DC ground.	

Application Circuit
**Recommended Bias Resistor Values
for $I_{cc} = 50 \text{ mA}$, $R_{bias} = (V_s - 5.0) / I_{cc}$**

Supply Voltage (V_s)	5V	6V	8V
RBIAS VALUE	0 Ω	20 Ω	62 Ω
RBIAS POWER RATING		¼ W	½ W

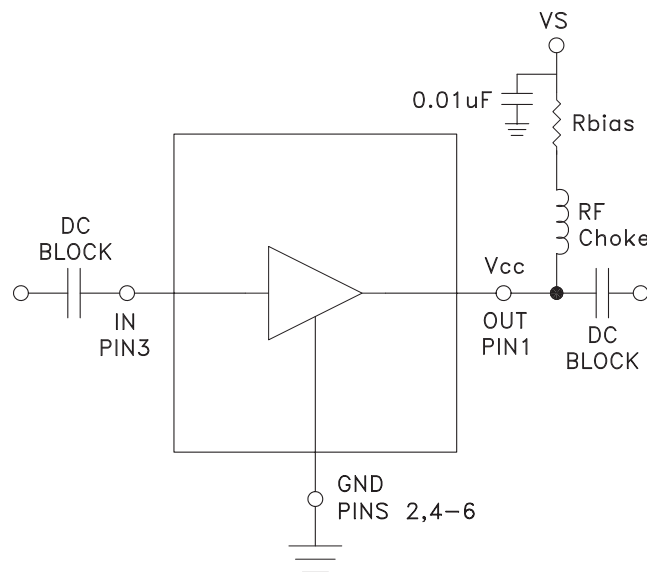
Note:

1. Select R_{bias} to achieve desired V_{cc} voltage on Pin 1.
2. External Blocking Capacitors are required on Pins 1 & 3.

Evaluation PCB

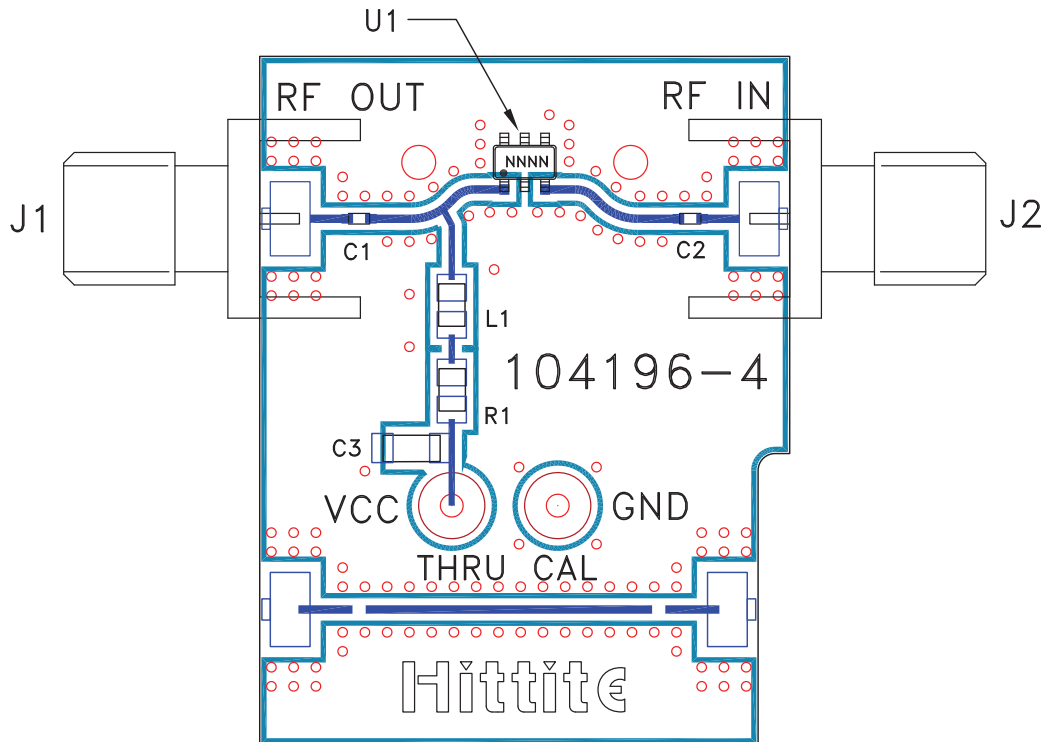

List of Materials for Evaluation PCB 104217 [1]

Item	Description
J1 - J2	PCB Mount SMA Connector
C1 - C2	100 pF Capacitor, 0402 Pkg.
C3	100 pF Capacitor, 0805 Pkg.
L1	22 nH Inductor, 0805 Pkg.
R1	22 Ω Resistor, 0805 Pkg.
U1	HMC313 / HMC313E
PCB [2]	104196 Evaluation PCB

[1] Reference this number when ordering complete evaluation PCB

[2] Circuit Board Material: Arlon 25FR or Roger 4350

The circuit board used in the final application should use RF circuit design techniques. Signal lines should have 50 ohm impedance while the package ground leads should be connected directly to the ground plane similar to that shown. A sufficient number of via holes should be used to connect the top and bottom ground planes. The evaluation circuit board shown is available from Hittite upon request.

Компания «Life Electronics» занимается поставками электронных компонентов импортного и отечественного производства от производителей и со складов крупных дистрибьюторов Европы, Америки и Азии.

С конца 2013 года компания активно расширяет линейку поставок компонентов по направлению коаксиальный кабель, кварцевые генераторы и конденсаторы (керамические, пленочные, электролитические), за счёт заключения дистрибьюторских договоров

Мы предлагаем:

- Конкурентоспособные цены и скидки постоянным клиентам.
- Специальные условия для постоянных клиентов.
- Подбор аналогов.
- Поставку компонентов в любых объемах, удовлетворяющих вашим потребностям.
- Приемлемые сроки поставки, возможна ускоренная поставка.
- Доставку товара в любую точку России и стран СНГ.
- Комплексную поставку.
- Работу по проектам и поставку образцов.
- Формирование склада под заказчика.
- Сертификаты соответствия на поставляемую продукцию (по желанию клиента).
- Тестирование поставляемой продукции.
- Поставку компонентов, требующих военную и космическую приемку.
- Входной контроль качества.
- Наличие сертификата ISO.

В составе нашей компании организован Конструкторский отдел, призванный помогать разработчикам, и инженерам.

Конструкторский отдел помогает осуществить:

- Регистрацию проекта у производителя компонентов.
- Техническую поддержку проекта.
- Защиту от снятия компонента с производства.
- Оценку стоимости проекта по компонентам.
- Изготовление тестовой платы монтаж и пусконаладочные работы.



Тел: +7 (812) 336 43 04 (многоканальный)

Email: org@lifeelectronics.ru