

FEATURES

- +3.3 Volt power supply
- Fast 35 ns read/write cycle
- SRAM compatible timing
- Unlimited read & write endurance
- Data always non-volatile for >20 years at temperature
- RoHS-compliant small footprint BGA and TSOP2 package
- All products meet MSL-3 moisture sensitivity level



BENEFITS

- One memory replaces FLASH, SRAM, EEPROM and BBSRAM in systems for simpler, more efficient designs
- Improves reliability by replacing battery-backed SRAM



INTRODUCTION

The MR4A16B is a 16,777,216-bit magnetoresistive random access memory (MRAM) device organized as 1,048,576 words of 16 bits. The MR4A16B offers SRAM compatible 35 ns read/write timing with unlimited endurance. Data is always non-volatile for greater than 20 years. Data is automatically protected on power loss by low-voltage inhibit circuitry to prevent writes with voltage out of specification. To simplify fault tolerant design, the MR4A16B includes internal single bit error correction code with 7 ECC parity bits for every 64 data bits. The MR4A16B is the ideal memory solution for applications that must permanently store and retrieve critical data and programs quickly.



The **MR4A16B** is available in a small footprint 48-pin ball grid array (BGA) package and a 54-pin thin small outline package (TSOP Type 2). These packages are compatible with similar low-power SRAM products and other nonvolatile RAM products.

The **MR4A16B** provides highly reliable data storage over a wide range of temperatures. The product is offered with commercial temperature (0 to +70 °C), and industrial temperature (-40 to +85 °C) operating temperature options.

CONTENTS

1. DEVICE PIN ASSIGNMENT.....	3
2. ELECTRICAL SPECIFICATIONS.....	4
3. TIMING SPECIFICATIONS.....	7
4. ORDERING INFORMATION.....	12
5. MECHANICAL DRAWING.....	13
6. REVISION HISTORY.....	15
How to Reach Us.....	16

1. DEVICE PIN ASSIGNMENT

Figure 1.1 Block Diagram

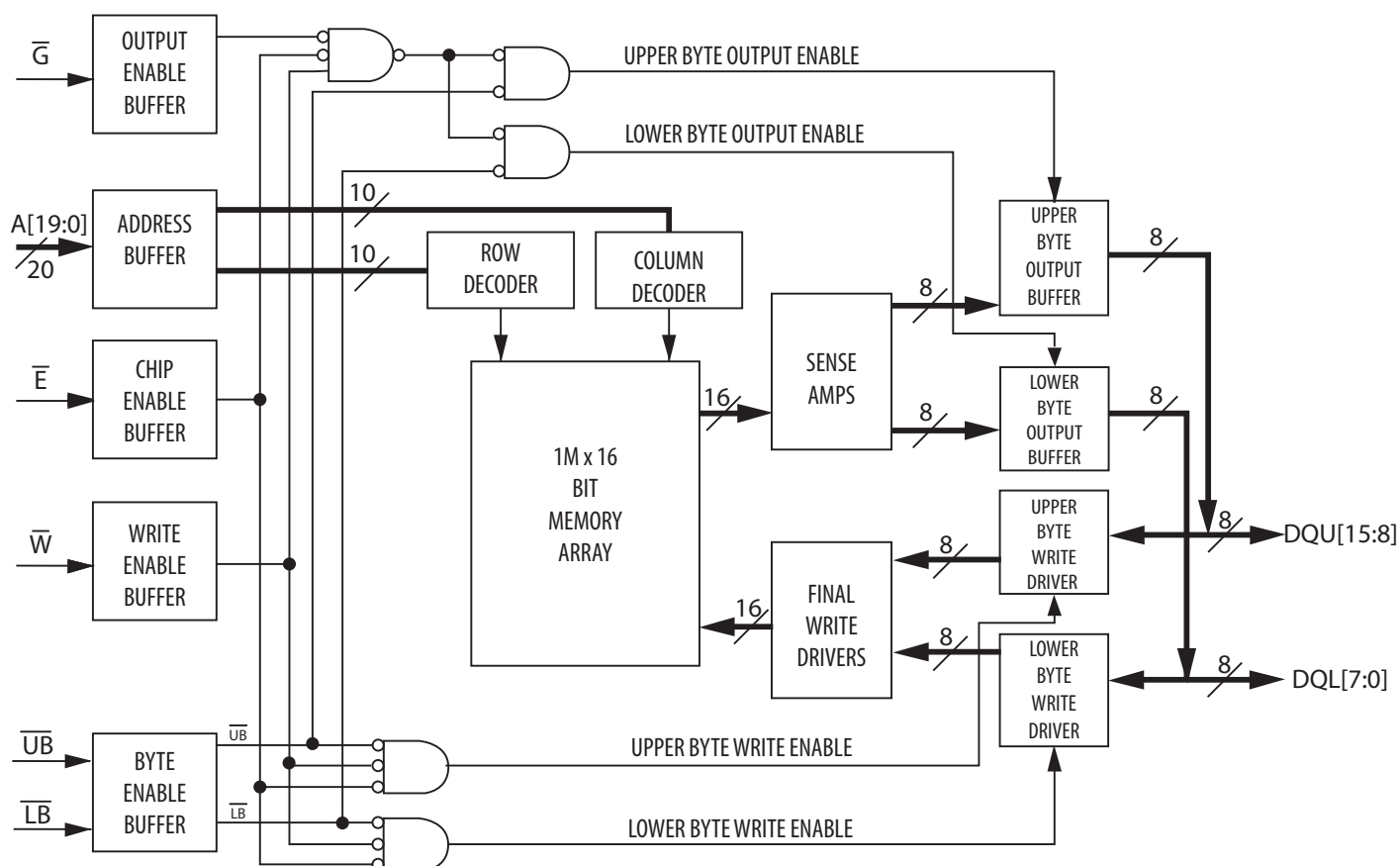
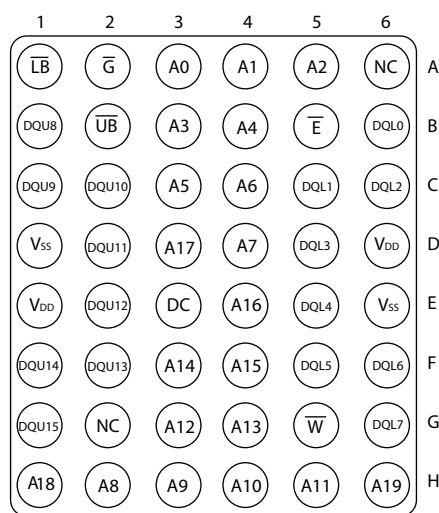

Table 1.1 Pin Functions

Signal Name	Function
A	Address Input
\bar{E}	Chip Enable
\bar{W}	Write Enable
\bar{G}	Output Enable
\bar{UB}	Upper Byte Enable
\bar{LB}	Lower Byte Enable
DQ	Data I/O
V_{DD}	Power Supply
V_{SS}	Ground
DC	Do Not Connect
NC	No Connection

Figure 1.1 Pin Diagrams for Available Packages (Top View)



48-Pin BGA

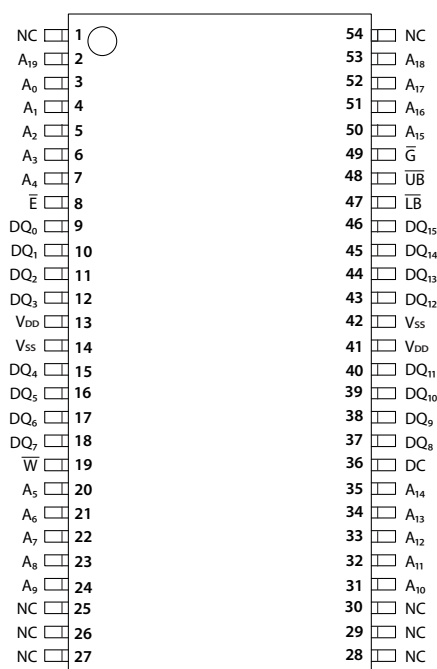

54-Pin TSOP2

Table 1.2 Operating Modes

\bar{E}^1	\bar{G}^1	\bar{W}^1	\bar{LB}^1	\bar{UB}^1	Mode	V_{DD} Current	DQL[7:0] ²	DQU[15:8] ²
H	X	X	X	X	Not selected	I_{SB1}, I_{SB2}	Hi-Z	Hi-Z
L	H	H	X	X	Output disabled	I_{DDR}	Hi-Z	Hi-Z
L	X	X	H	H	Output disabled	I_{DDR}	Hi-Z	Hi-Z
L	L	H	L	H	Lower Byte Read	I_{DDR}	D _{Out}	Hi-Z
L	L	H	H	L	Upper Byte Read	I_{DDR}	Hi-Z	D _{Out}
L	L	H	L	L	Word Read	I_{DDR}	D _{Out}	D _{Out}
L	X	L	L	H	Lower Byte Write	I_{DDW}	D _{in}	Hi-Z
L	X	L	H	L	Upper Byte Write	I_{DDW}	Hi-Z	D _{in}
L	X	L	L	L	Word Write	I_{DDW}	D _{in}	D _{in}

¹ H = high, L = low, X = don't care

² Hi-Z = high impedance

2. ELECTRICAL SPECIFICATIONS

Absolute Maximum Ratings

This device contains circuitry to protect the inputs against damage caused by high static voltages or electric fields; however, it is advised that normal precautions be taken to avoid application of any voltage greater than maximum rated voltages to these high-impedance (Hi-Z) circuits.

The device also contains protection against external magnetic fields. Precautions should be taken to avoid application of any magnetic field greater than the maximum field intensity specified in the maximum ratings.

Table 2.1 Absolute Maximum Ratings¹

Symbol	Parameter	Conditions	Value	Unit
V_{DD}	Supply voltage ²		-0.5 to 4.0	V
V_{IN}	Voltage on an pin ²		-0.5 to $V_{DD} + 0.5$	V
I_{OUT}	Output current per pin		±20	mA
P_D	Package power dissipation ³		0.600	W
T_{BIAS}	Temperature under bias	Commercial	-10 to 85	°C
		Industrial	-45 to 95	°C
T_{stg}	Storage Temperature		-55 to 150	°C
T_{Lead}	Lead temperature during solder (3 minute max)		260	°C
H_{max_write}	Maximum magnetic field	During Write	8000	A/m
H_{max_read}	Maximum magnetic field	During Read or Standby		

¹ Permanent device damage may occur if absolute maximum ratings are exceeded. Functional operation should be restricted to recommended operating conditions. Exposure to excessive voltages or magnetic fields could affect device reliability.

² All voltages are referenced to V_{SS} . The DC value of V_{IN} must not exceed actual applied V_{DD} by more than 0.5V. The AC value of V_{IN} must not exceed applied V_{DD} by more than 2V for 10ns with I_{IN} limited to less than 20mA.

³ Power dissipation capability depends on package characteristics and use environment.

Table 2.2 Operating Conditions

Symbol	Parameter	Temp Range	Min	Typical	Max	Unit
V_{DD}	Power supply voltage		3.0 ¹	3.3	3.6	V
V_{WI}	Write inhibit voltage		2.5	2.7	3.0 ¹	V
V_{IH}	Input high voltage		2.2	-	$V_{DD} + 0.3$ ²	V
V_{IL}	Input low voltage		-0.5 ³	-	0.8	V
T_A	Temperature under bias	Commercial	0	-	70	°C
		Industrial	-40	-	85	°C

¹ There is a 2 ms startup time once V_{DD} exceeds $V_{DD}(\min)$. See **Power Up and Power Down Sequencing** below.

² $V_{IH}(\max) = V_{DD} + 0.3 V_{DC}$; $V_{IH}(\max) = V_{DD} + 2.0 V_{AC}$ (pulse width ≤ 10 ns) for $I \leq 20.0$ mA.

³ $V_{IL}(\min) = -0.5 V_{DC}$; $V_{IL}(\min) = -2.0 V_{AC}$ (pulse width ≤ 10 ns) for $I \leq 20.0$ mA.

Power Up and Power Down Sequencing

The MRAM is protected from write operations whenever V_{DD} is less than V_{WI} . As soon as V_{DD} exceeds $V_{DD}(\min)$, there is a startup time of 2 ms before read or write operations can start. This time allows memory power supplies to stabilize.

The \bar{E} and \bar{W} control signals should track V_{DD} on power up to $V_{DD} - 0.2$ V or V_{IH} (whichever is lower) and remain high for the startup time. In most systems, this means that these signals should be pulled up with a resistor so that a signal remains high if the driving signal is Hi-Z during power up. Any logic that drives \bar{E} and \bar{W} should hold the signals high with a power-on reset signal for longer than the startup time.

During power loss or brownout where V_{DD} goes below V_{WI} , writes are protected and a startup time must be observed when power returns above $V_{DD}(\min)$.

Figure 2.1 Power Up and Power Down Diagram

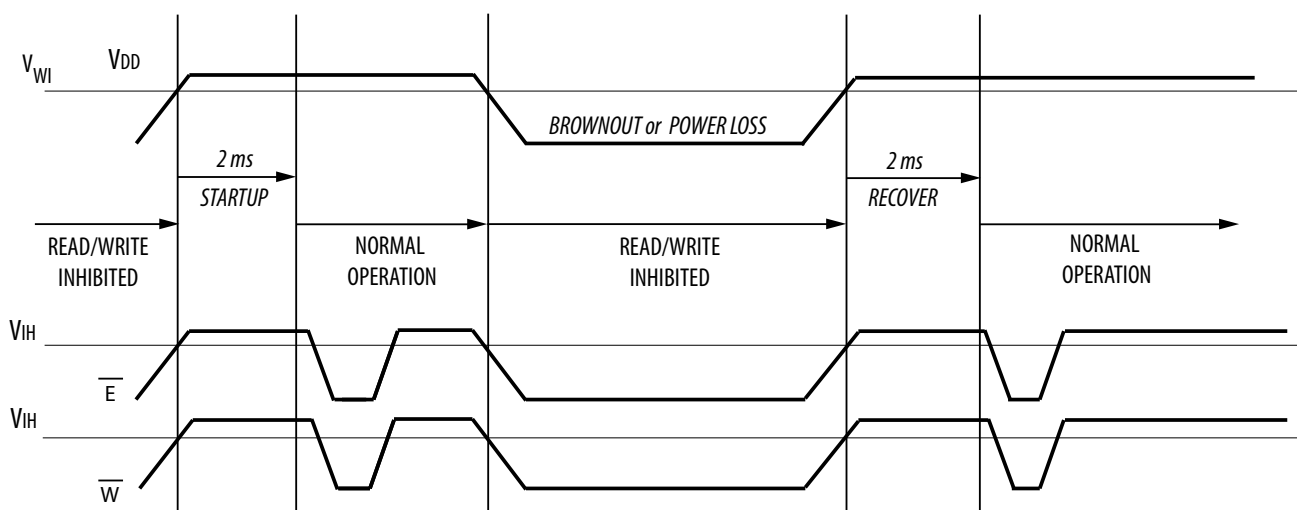

Table 2.3 DC Characteristics

Symbol	Parameter	Conditions	Min	Max	Unit
$I_{lkg(I)}$	Input leakage current	All	-	± 1	μA
$I_{lkg(O)}$	Output leakage current	All	-	± 1	μA
V_{OL}	Output low voltage	$I_{OL} = +4 \text{ mA}$	-	0.4	V
		$I_{OL} = +100 \mu\text{A}$		$V_{SS} + 0.2$	V
V_{OH}	Output high voltage	$I_{OH} = -4 \text{ mA}$	2.4	-	V
		$I_{OH} = -100 \mu\text{A}$	$V_{DD} - 0.2$	-	V

Table 2.4 Power Supply Characteristics

Symbol	Parameter	Typical	Max	Unit
I_{DDR}	AC active supply current - read modes ¹ ($I_{OUT} = 0 \text{ mA}$, $V_{DD} = \text{max}$)	60	68	mA
I_{DDW}	AC active supply current - write modes ¹ ($V_{DD} = \text{max}$)	152	180	mA
I_{SB1}	AC standby current ($V_{DD} = \text{max}$, $\bar{E} = V_{IH}$) <i>no other restrictions on other inputs</i>	9	14	mA
I_{SB2}	CMOS standby current ($\bar{E} \geq V_{DD} - 0.2 \text{ V}$ and $V_{In} \leq V_{SS} + 0.2 \text{ V}$ or $\geq V_{DD} - 0.2 \text{ V}$) ($V_{DD} = \text{max}$, $f = 0 \text{ MHz}$)	5	9	mA

¹ All active current measurements are measured with one address transition per cycle and at minimum cycle time.

3. TIMING SPECIFICATIONS

Table 3.1 Capacitance ¹

Symbol	Parameter	Typical	Max	Unit
C_{In}	Address input capacitance	-	6	pF
C_{In}	Control input capacitance	-	6	pF
$C_{I/O}$	Input/Output capacitance	-	8	pF

¹f = 1.0 MHz, dV = 3.0 V, T_A = 25 °C, periodically sampled rather than 100% tested.

Table 3.2 AC Measurement Conditions

Parameter	Value	Unit
Logic input timing measurement reference level	1.5	V
Logic output timing measurement reference level	1.5	V
Logic input pulse levels	0 or 3.0	V
Input rise/fall time	2	ns
Output load for low and high impedance parameters	See Figure 3.1	
Output load for all other timing parameters	See Figure 3.2	

Figure 3.1 Output Load Test Low and High

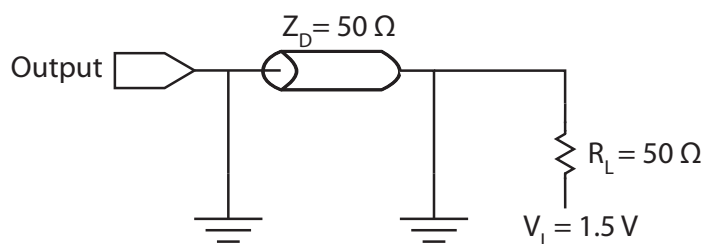
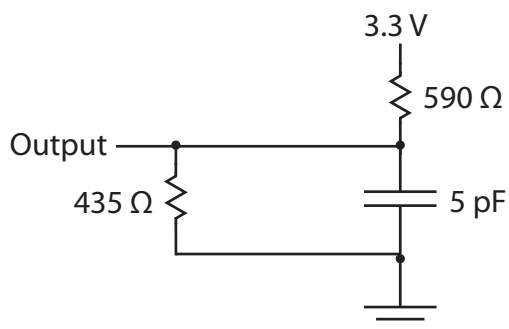

Figure 3.2 Output Load Test All Others



Read Mode

Table 3.3 Read Cycle Timing ¹

Symbol	Parameter	Min	Max	Unit
t_{AVAV}	Read cycle time	35	-	ns
t_{AVQV}	Address access time	-	35	ns
t_{ELQV}	Enable access time ²	-	35	ns
t_{GLQV}	Output enable access time	-	15	ns
t_{BLQV}	Byte enable access time	-	15	ns
t_{AXQX}	Output hold from address change	3	-	ns
t_{ELQX}	Enable low to output active ³	3	-	ns
t_{GLQX}	Output enable low to output active ³	0	-	ns
t_{BLQX}	Byte enable low to output active ³	0	-	ns
t_{EHQZ}	Enable high to output Hi-Z ³	0	15	ns
t_{GHQZ}	Output enable high to output Hi-Z ³	0	10	ns
t_{BHQZ}	Byte high to output Hi-Z ³	0	10	ns

¹ \bar{W} is high for read cycle. Power supplies must be properly grounded and decoupled, and bus contention conditions must be minimized or eliminated during read or write cycles.

² Addresses valid before or at the same time \bar{E} goes low.

³ This parameter is sampled and not 100% tested. Transition is measured ± 200 mV from the steady-state voltage.

Figure 3.3A Read Cycle 1

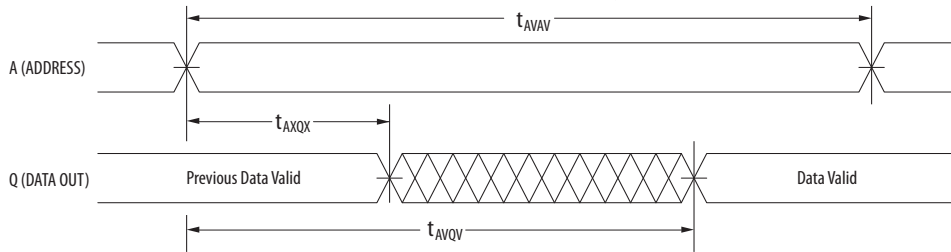

Note: Device is continuously selected ($\bar{E} \leq V_{IL}$, $\bar{G} \leq V_{IL}$).

Figure 3.3B Read Cycle 2

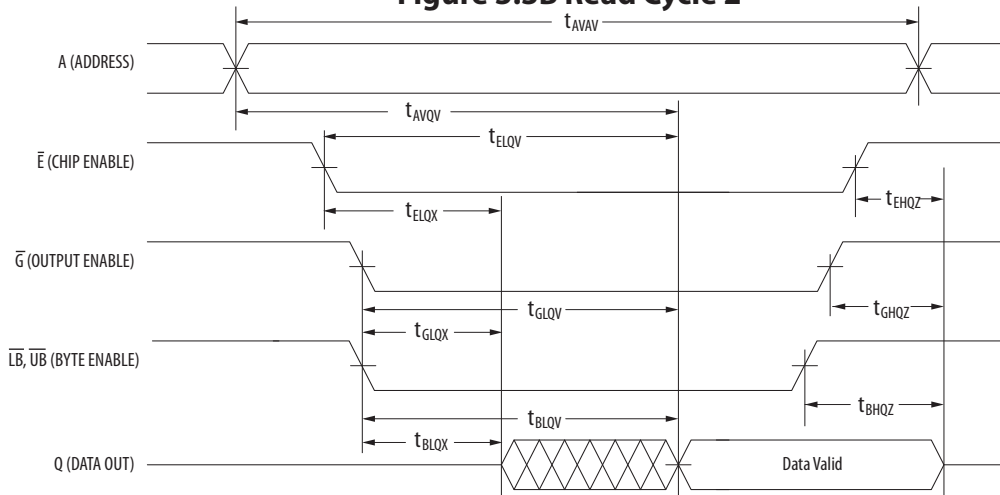

Table 3.4 Write Cycle Timing 1 (\overline{W} Controlled) ¹

Symbol	Parameter	Min	Max	Unit
t_{AVAV}	Write cycle time ²	35	-	ns
t_{AVWL}	Address set-up time	0	-	ns
t_{AVWH}	Address valid to end of write (\overline{G} high)	20	-	ns
t_{AVWH}	Address valid to end of write (\overline{G} low)	20	-	ns
t_{WLWH} t_{WLEH}	Write pulse width (\overline{G} high)	15	-	ns
t_{WLWH} t_{WLEH}	Write pulse width (\overline{G} low)	15	-	ns
t_{DVWH}	Data valid to end of write	10	-	ns
t_{WHDX}	Data hold time	0	-	ns
t_{WLQZ}	Write low to data Hi-Z ³	0	15	ns
t_{WHQX}	Write high to output active ³	3	-	ns
t_{WHAX}	Write recovery time	12	-	ns

¹ All write occurs during the overlap of \overline{E} low and \overline{W} low. Power supplies must be properly grounded and decoupled and bus contention conditions must be minimized or eliminated during read and write cycles. If \overline{G} goes low at the same time or after \overline{W} goes low, the output will remain in a high impedance state. After \overline{W} , \overline{E} or $\overline{UB/LB}$ has been brought high, the signal must remain in steady-state high for a minimum of 2 ns. The minimum time between \overline{E} being asserted low in one cycle to \overline{E} being asserted low in a subsequent cycle is the same as the minimum cycle time allowed for the device.

² All write cycle timings are referenced from the last valid address to the first transition address.

³ This parameter is sampled and not 100% tested. Transition is measured ± 200 mV from the steady-state voltage. At any given voltage or temperature, $t_{WLQZ}(\text{max}) < t_{WHQX}(\text{min})$.

Figure 3.4 Write Cycle Timing 1 (\overline{W} Controlled)

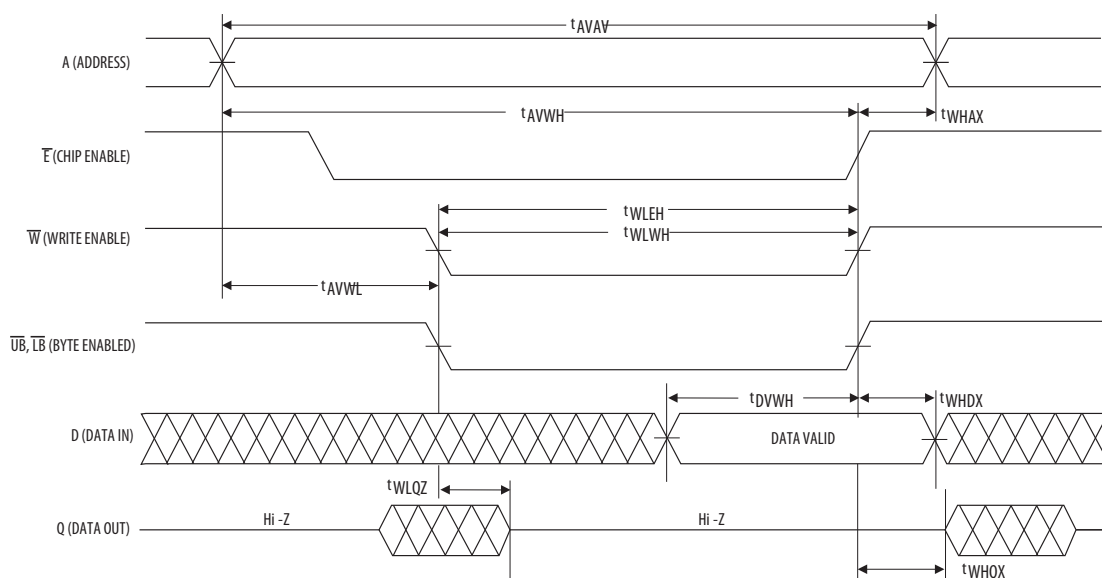

Table 3.5 Write Cycle Timing 2 (\bar{E} Controlled) ¹

Symbol	Parameter	Min	Max	Unit
t_{AVAV}	Write cycle time ²	35	-	ns
t_{AVEL}	Address set-up time	0	-	ns
t_{AVEH}	Address valid to end of write (\bar{G} high)	20	-	ns
t_{AVEH}	Address valid to end of write (\bar{G} low)	20	-	ns
t_{ELEH} t_{ELWH}	Enable to end of write (\bar{G} high)	15	-	ns
t_{ELEH} t_{ELWH}	Enable to end of write (\bar{G} low) ³	15	-	ns
t_{DVEH}	Data valid to end of write	10	-	ns
t_{EHDX}	Data hold time	0	-	ns
t_{EHAX}	Write recovery time	12	-	ns

¹ All write occurs during the overlap of \bar{E} low and \bar{W} low. Power supplies must be properly grounded and decoupled and bus contention conditions must be minimized or eliminated during read and write cycles. If \bar{G} goes low at the same time or after \bar{W} goes low, the output will remain in a high impedance state. After \bar{W} , \bar{E} or \bar{UB}/\bar{LB} has been brought high, the signal must remain in steady-state high for a minimum of 2 ns. The minimum time between \bar{E} being asserted low in one cycle to \bar{E} being asserted low in a subsequent cycle is the same as the minimum cycle time allowed for the device.

² All write cycle timings are referenced from the last valid address to the first transition address.

³ If \bar{E} goes low at the same time or after \bar{W} goes low, the output will remain in a high-impedance state. If \bar{E} goes high at the same time or before \bar{W} goes high, the output will remain in a high-impedance state.

Figure 3.5 Write Cycle Timing 2 (\bar{E} Controlled)

Table 3.6 Write Cycle Timing 3 ($\overline{\text{LB}}/\overline{\text{UB}}$ Controlled) ¹

Symbol	Parameter	Min	Max	Unit
t_{AVAV}	Write cycle time ²	35	-	ns
t_{AVBL}	Address set-up time	0	-	ns
t_{AVBH}	Address valid to end of write ($\overline{\text{G}}$ high)	20	-	ns
t_{AVBH}	Address valid to end of write ($\overline{\text{G}}$ low)	20	-	ns
t_{BLEH} t_{BLWH}	Write pulse width ($\overline{\text{G}}$ high)	15	-	ns
t_{BLEH} t_{BLWH}	Write pulse width ($\overline{\text{G}}$ low)	15	-	ns
t_{DVBH}	Data valid to end of write	10	-	ns
t_{BHDX}	Data hold time	0	-	ns
t_{BHAX}	Write recovery time	12	-	ns

¹ All write occurs during the overlap of $\overline{\text{E}}$ low and $\overline{\text{W}}$ low. Power supplies must be properly grounded and decoupled and bus contention conditions must be minimized or eliminated during read and write cycles. If $\overline{\text{G}}$ goes low at the same time or after $\overline{\text{W}}$ goes low, the output will remain in a high impedance state. After $\overline{\text{W}}$, $\overline{\text{E}}$ or $\overline{\text{UB}}/\overline{\text{LB}}$ has been brought high, the signal must remain in steady-state high for a minimum of 2 ns. If both byte control signals are asserted, the two signals must have no more than 2 ns skew between them. The minimum time between $\overline{\text{E}}$ being asserted low in one cycle to $\overline{\text{E}}$ being asserted low in a subsequent cycle is the same as the minimum cycle time allowed for the device.

² All write cycle timings are referenced from the last valid address to the first transition address.

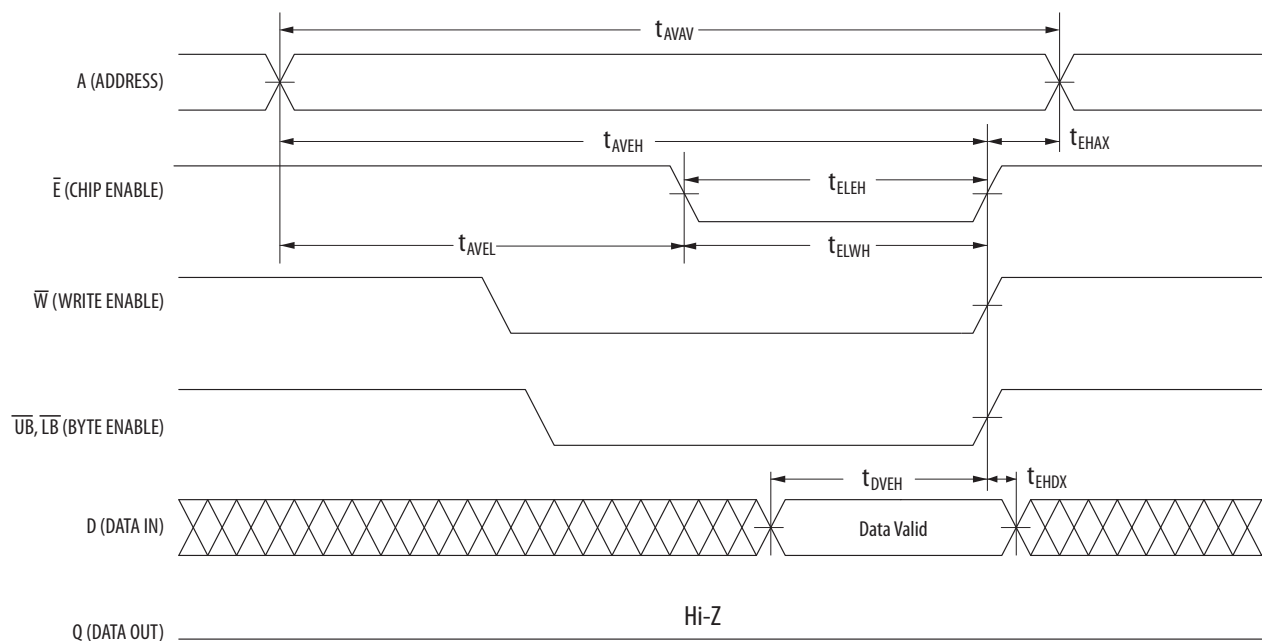
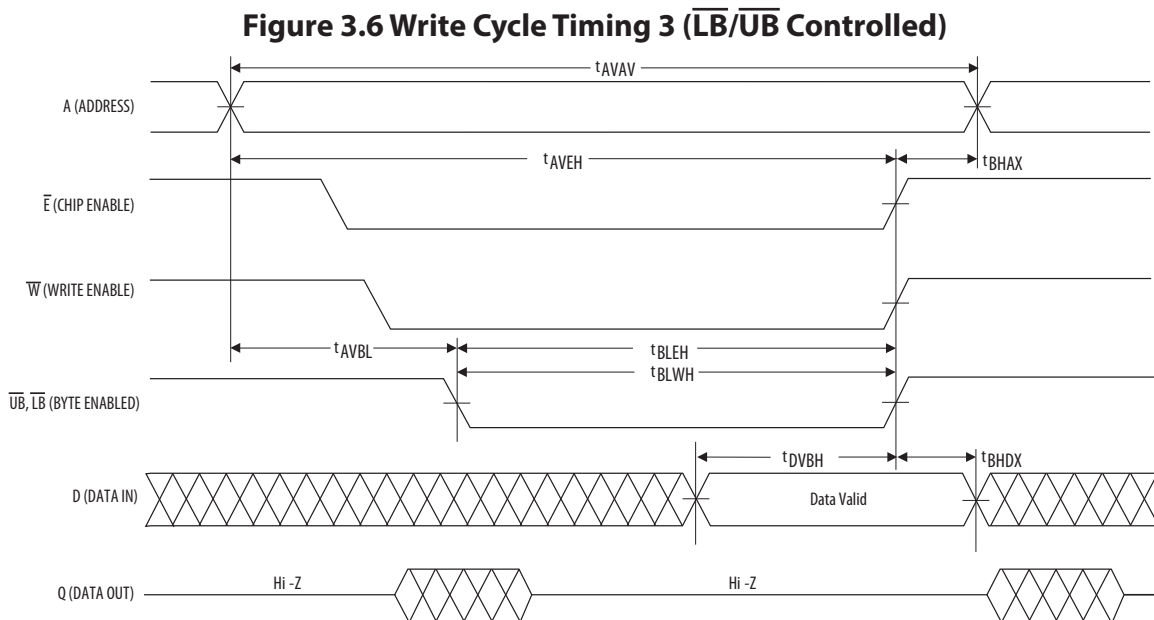

4. ORDERING INFORMATION

Figure 4.1 Part Numbering System

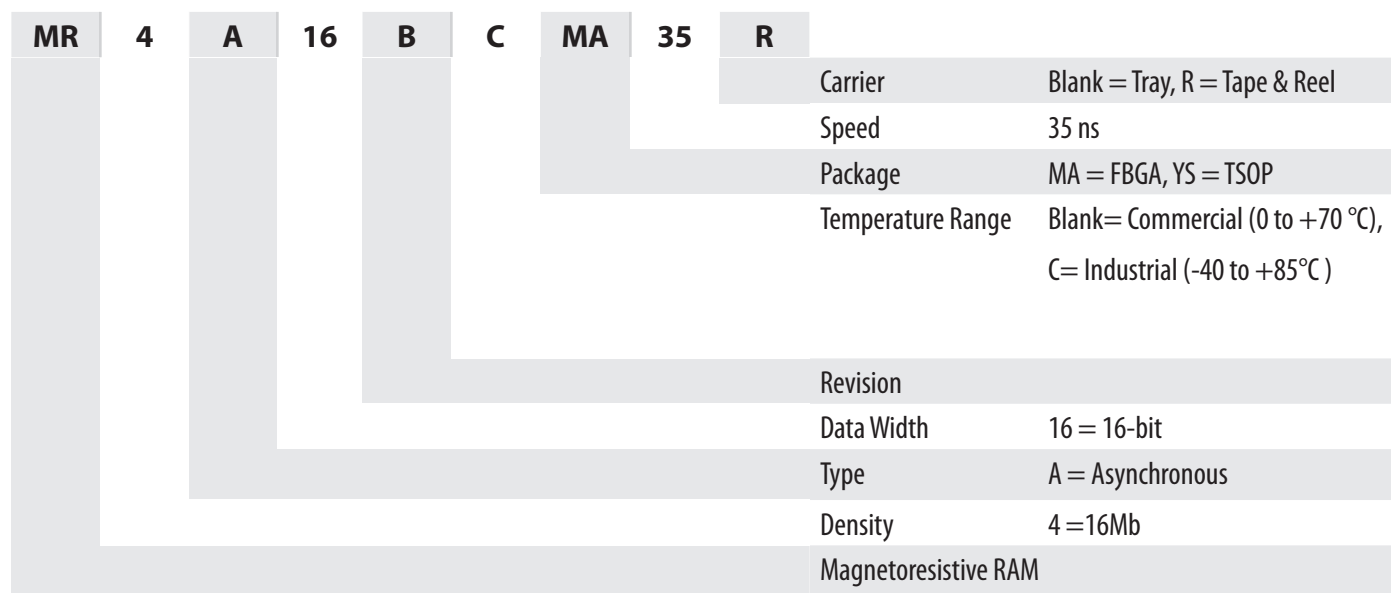
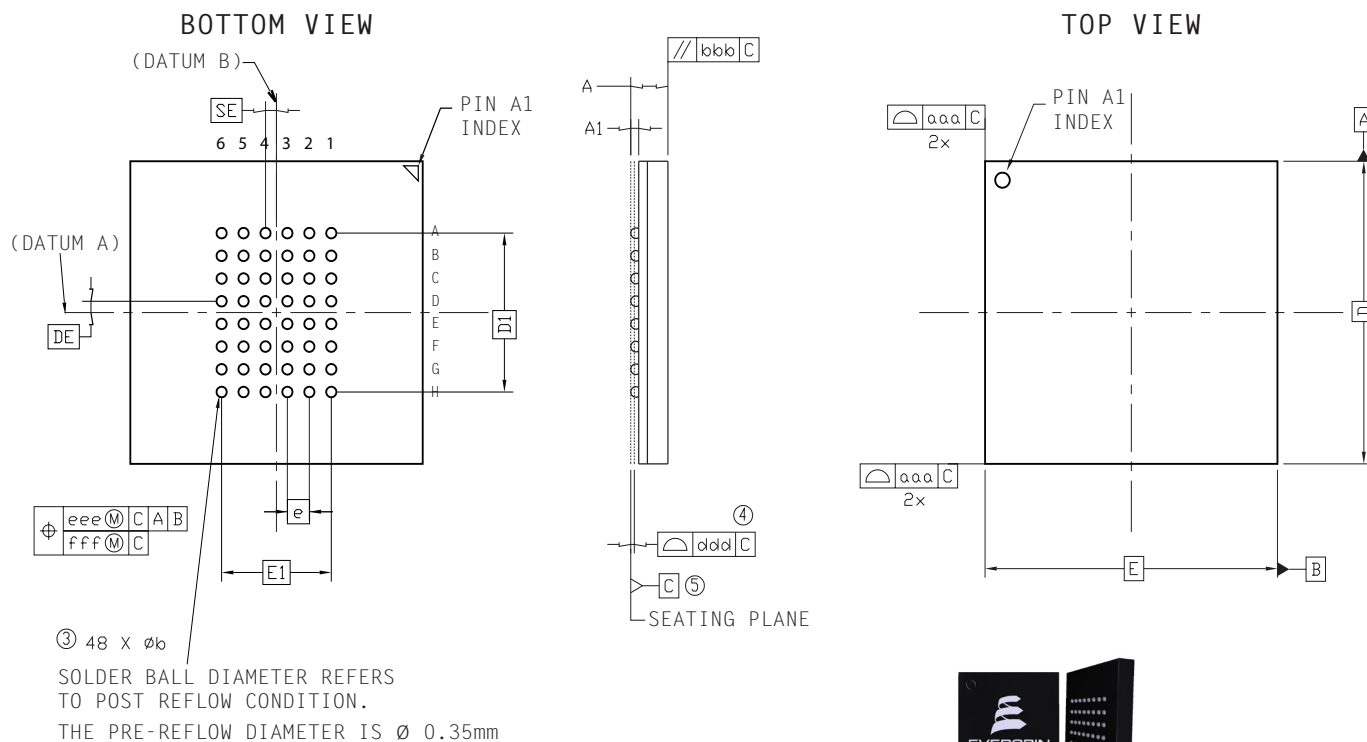

Table 4.1 Available Parts

Grade	Temp Range	Package	Shipping Container	Order Part Number
Commercial	0 to +70 °C	48-BGA	Trays	MR4A16BMA35
			Tape & Reel	MR4A16BMA35R
		54-TSOP2	Trays	MR4A16BYS35
			Tape & Reel	MR4A16BYS35R
Industrial	-40 to +85°C	48-BGA	Tray	MR4A16BCMA35
			Tape & Reel	MR4A16BCMA35R
		54-TSOP2	Tray	MR4A16BCYS35
			Tape & Reel	MR4A16BCYS35R

5. MECHANICAL DRAWING

Figure 5.1 48-FBGA



Print Version Not To Scale

Ref	Min	Nominal	Max
A	1.19	1.27	1.35
A1	0.22	0.27	0.32
b	0.31	0.36	0.41
D	10.00 BSC		
E	10.00 BSC		
D1	5.25 BSC		
E1	3.75 BSC		
DE	0.375 BSC		
SE	0.375 BSC		
e	0.75 BSC		

Ref	Tolerance of, from and position
aaa	0.10
bbb	0.10
ddd	0.10
eee	0.15
fff	0.08

1. Dimensions in Millimeters.
2. The 'e' represents the basic solder ball grid pitch.
- ③ 'b' is measurable at the maximum solder ball diameter in a plane parallel to datum C.
- ④ Dimension 'ddd' is measured parallel to primary datum C.
- ⑤ Primary datum C (seating plane) is defined by the crowns of the solder balls.
6. Package dimensions refer to JEDEC MO-205 Rev. G.

5. MECHANICAL DRAWING

Figure 5.2 54-TSOP2

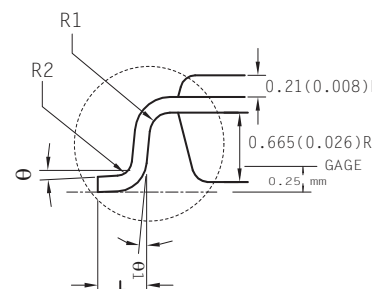
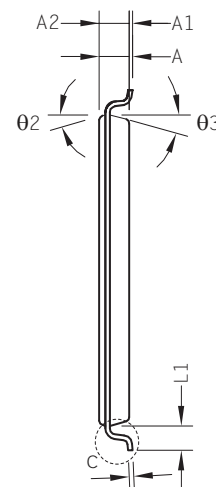
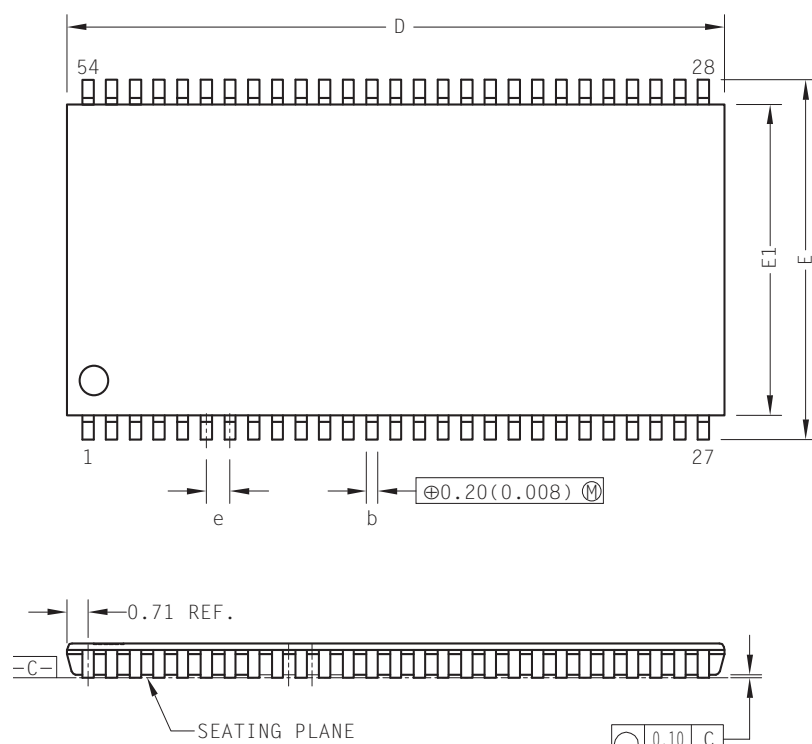

Ref	Min	Nominal	Max
A			1.20
A1	0.05	0.10	0.15
A2	0.95	1.00	1.05
b	0.30	0.35	0.45
c	0.12		0.21
D	22.10	22.22	22.35
E	11.56	11.76	11.95
E1	10.03	10.16	10.29
e	0.80 BSC		
L	0.40	0.50	0.60
L1	0.80 REF		
R1	0.12	-	-
R2	0.12	-	0.25
θ	0°	-	8°
θ1	0.40	-	-
θ2	15° REF		
θ3	15° REF		

Print Version Not To Scale

1. Dimensions in Millimeters.
2. Package dimensions refer to JEDEC MS-024



6. REVISION HISTORY

Rev	Date	Description of Change
1	May 29, 2009	Establish Speed and Power Specifications
2	July 27, 2009	Increase BGA Package to 11 mm x 11 mm
3	Nov 26, 2009	Changed ball definition of H6 to A19 and G2 to NC in Figure 1.2.
4	Mar 10, 2010	Changed speed marking and timing specs to 35 ns part. Changed BGA package to 10 mm x 10mm
5	Apr 7, 2010	Added 54-TSOP package options.
6	Oct 7, 2011	Added AEC-Q100 Grade 1 product option. Max. magnetic field during write (H_{max_write}) increased to 8000 A/m. Revised IDDW typical from 110 to 152mA, max from TBD to 180mA; IDDR max from TBD to 68mA; ISB1 typical from 11 to 9mA; ISB2 from typical 7 to 5mA.
7	Oct 28, 2011	Added note to BGA package option products are MSL-6 only, MSL-3 qualification underway. Fixed typo on BGA drawing: Top View incorrectly labeled Bottom View.
8	August 6, 2012	Figure 2.1 Power Up and Power Down Timing redrawn. Added 54-TSOP illustrations. Reformatted all parametric tables. Reformatted Table 4.1 Ordering Part Numbers.
9	August 27, 2013	Corrected the AEC Q-100 Grade A ordering option to be available in 54-TSOP2, not 48-BGA.
9.1	January 29, 2014	Corrected minor typo in Ordering PN table.
10	April 25, 2014	AEC-Q100 removed until qualified product is available.
11	September 17, 2014	48-BGA package options moisture sensitivity level upgraded to MSL-5.
11.1	May 19, 2015	Revised Everspin contact information.
11.2	June 11, 2015	Corrected Japan Sales Office telephone number.
11.3	July 29, 2015	Minor correction to the 'ddd' tolerance value for the BGA Package (Note 4.)
11.4	March 11, 2016	The BGA package moisture sensitivity level rating is changed to MSL-6 in Table 4.1.
11.5	November 22, 2016	The BGA package moisture sensitivity level rating is changed to MSL-5 in Table 4.1.
11.6	May 09, 2017	All products meet MSL-3 moisture sensitivity level
11.7	March 23, 2018	Updated the Contact Us table

7. HOW TO CONTACT US

How to Reach Us:

Home Page:

www.everspin.com

World Wide Information Request

WW Headquarters - Chandler, AZ

5670 W. Chandler Blvd., Suite 100

Chandler, Arizona 85226

Tel: +1-877-480-MRAM (6726)

Local Tel: +1-480-347-1111

Fax: +1-480-347-1175

support@everspin.com

orders@everspin.com

sales@everspin.com

Europe, Middle East and Africa

Everspin Europe Support

support.europe@everspin.com

Japan

Everspin Japan Support

support.japan@everspin.com

Asia Pacific

Everspin Asia Support

support.asia@everspin.com

Filename:

EST00352_MR4A16B_Datasheet_Rev11.7032318

Everspin Technologies, Inc.

Information in this document is provided solely to enable system and software implementers to use Everspin Technologies products. There are no express or implied licenses granted hereunder to design or fabricate any integrated circuit or circuits based on the information in this document. Everspin Technologies reserves the right to make changes without further notice to any products herein. Everspin makes no warranty, representation or guarantee regarding the suitability of its products for any particular purpose, nor does Everspin Technologies assume any liability arising out of the application or use of any product or circuit, and specifically disclaims any and all liability, including without limitation consequential or incidental damages. "Typical" parameters, which may be provided in Everspin Technologies data sheets and/or specifications can and do vary in different applications and actual performance may vary over time. All operating parameters including "Typicals" must be validated for each customer application by customer's technical experts. Everspin Technologies does not convey any license under its patent rights nor the rights of others. Everspin Technologies products are not designed, intended, or authorized for use as components in systems intended for surgical implant into the body, or other applications intended to support or sustain life, or for any other application in which the failure of the Everspin Technologies product could create a situation where personal injury or death may occur. Should Buyer purchase or use Everspin Technologies products for any such unintended or unauthorized application, Buyer shall indemnify and hold Everspin Technologies and its officers, employees, subsidiaries, affiliates, and distributors harmless against all claims, costs, damages, and expenses, and reasonable attorney fees arising out of, directly or indirectly, any claim of personal injury or death associated with such unintended or unauthorized use, even if such claim alleges that Everspin Technologies was negligent regarding the design or manufacture of the part. Everspin™ and the Everspin logo are trademarks of Everspin Technologies, Inc. All other product or service names are the property of their respective owners.

Copyright © 2018 Everspin Technologies, Inc.



Компания «Life Electronics» занимается поставками электронных компонентов импортного и отечественного производства от производителей и со складов крупных дистрибьюторов Европы, Америки и Азии.

С конца 2013 года компания активно расширяет линейку поставок компонентов по направлению коаксиальный кабель, кварцевые генераторы и конденсаторы (керамические, пленочные, электролитические), за счёт заключения дистрибьюторских договоров

Мы предлагаем:

- Конкурентоспособные цены и скидки постоянным клиентам.
- Специальные условия для постоянных клиентов.
- Подбор аналогов.
- Поставку компонентов в любых объемах, удовлетворяющих вашим потребностям.
- Приемлемые сроки поставки, возможна ускоренная поставка.
- Доставку товара в любую точку России и стран СНГ.
- Комплексную поставку.
- Работу по проектам и поставку образцов.
- Формирование склада под заказчика.
- Сертификаты соответствия на поставляемую продукцию (по желанию клиента).
- Тестирование поставляемой продукции.
- Поставку компонентов, требующих военную и космическую приемку.
- Входной контроль качества.
- Наличие сертификата ISO.

В составе нашей компании организован Конструкторский отдел, призванный помогать разработчикам, и инженерам.

Конструкторский отдел помогает осуществить:

- Регистрацию проекта у производителя компонентов.
- Техническую поддержку проекта.
- Защиту от снятия компонента с производства.
- Оценку стоимости проекта по компонентам.
- Изготовление тестовой платы монтаж и пусконаладочные работы.



Тел: +7 (812) 336 43 04 (многоканальный)

Email: org@lifeelectronics.ru

www.lifeelectronics.ru