

## SDN-C Compact DIN Rail Series

The SDN-C DIN rail power supplies are the next generation of the popular SDN series. These models combine high efficiency and compact size with new visual diagnostic LEDs to offer the most performance available from SolaHD. Essential industrial features such as Sag Immunity, Power Factor Correction, and universal voltage input have been retained in this series. Wide temperature operating range and parallel operation capability make the new SDN-C units suitable to a variety of industrial applications.

### Applications

- Industrial Machine Control and Process Control
- Conveying Equipment
- Material Handling
- Vending Machines
- Packaging Equipment and Amusement Park Equipment
- Semiconductor Fabrication Equipment
- DeviceNet™

### Features



- Compact packaging to save space on the DIN rail
- Visual diagnostic LEDs for input and output status at a glance
- High MTBF means high reliability and long life
- Higher efficiency saves energy and lowers amount of heat generated in panel
- PowerBoost™ overload capability to start high inrush loads
- Accepts Universal voltage 85-264 Vac, 50/60 Hz input
- Active Power Factor Correction
- Patented DIN rail mounting clip
- User Adjustable output voltage accessible via front face
- Parallel capability standard
- Large, rugged, accessible screw terminals
- Industrial grade design
  - -25°C to 60°C operation without derating
- Fully tested and burned-in at factory
- Highly efficient switching technology
- Five year limited warranty

### Certifications and Compliances \*

#### All Models

-  Listed, Ind. Control Equipment, E61379
  - UL 508, CSA C22.2 No. 107.1





-  UL Recognized Component, ITE, E137632
  - UL 60950-1/CSA C22.2 No. 60950-1, 2nd Edition
-  - Low Voltage Directive
  - IEC/EN60950-1, 2nd Edition
- Sag Immunity: SEMI F47
- RoHS Compliant

#### Models SDN 20-24-100C, SDN 20-24-480CC, SDN 40-24-480C

-  UL Recognized Component, Haz. Loc., E234790
  - ISA 12.12.01, CSA C22.2 No. 213
  - Class I, Division 2, Groups A, B, C, D

#### Models SDN 5-24-100C, SDN 10-24-100C, SDN 40-24-100C, SDN 5-24-480C, SDN 10-24-480C

-  UL Recognized Component, Haz. Loc., E234790
  - UL 60079-15/CSA E60079-15
  - Class I, Zone 2, AEx nC IIC, Ex nC IIC
-  ATEX Directive
  - EN60079-0, EN60079-15
  -  II 3 G, Ex nC IIC Gc

### Related Products

- SDN-P series
- SDP™ series
- SCP series
- SDU UPS

### Accessories

- Chassis Mount Bracket (SDN-PMBRK2)

\* Refer to user manual for installation requirements when used in hazardous locations.

The SolaHD Difference

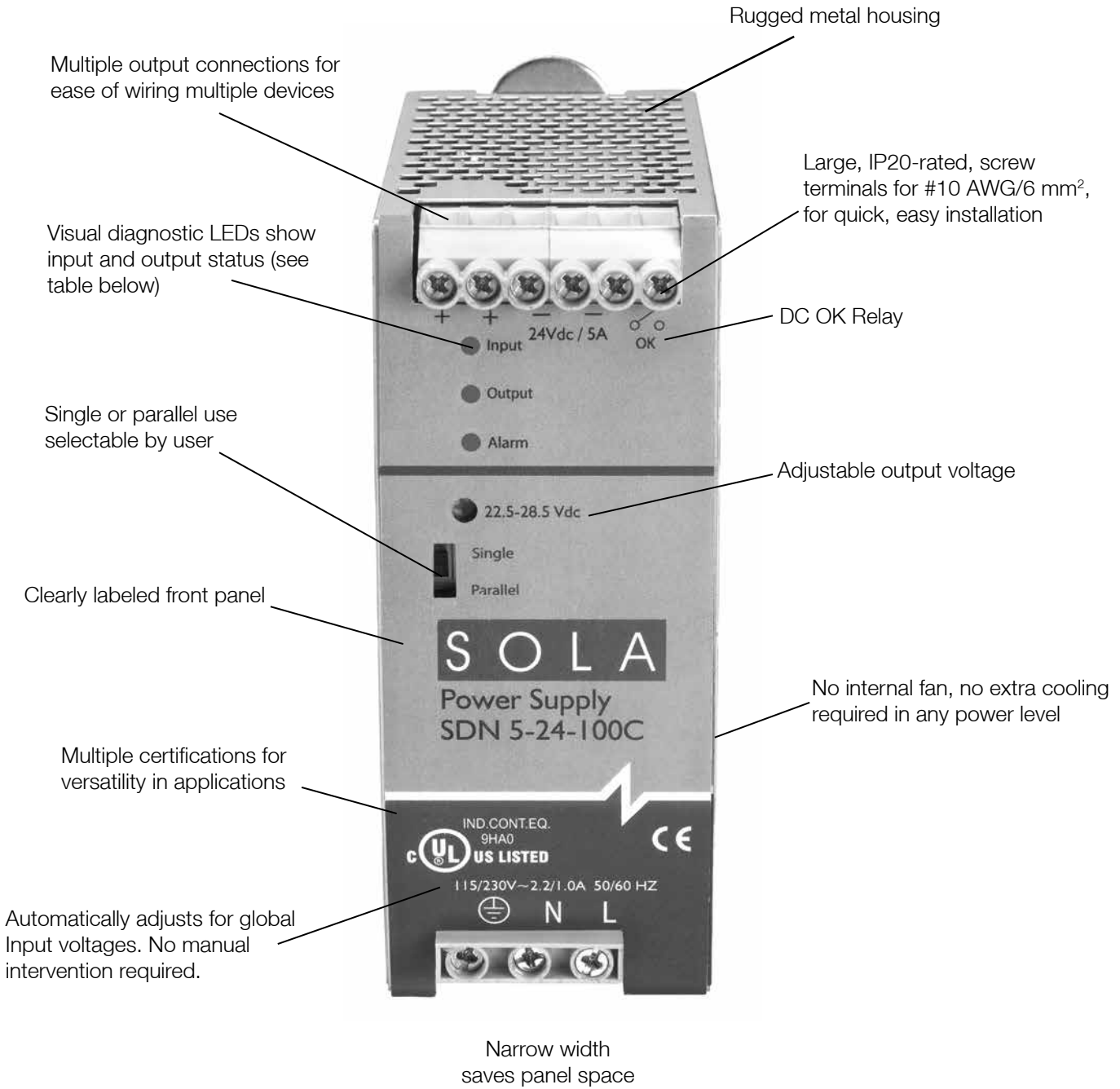

LED Light Status Conditions

|        | Normal | AC Power Loss | AC Input Low | No DC | High Load | Overload | Hot    | Too Hot |
|--------|--------|---------------|--------------|-------|-----------|----------|--------|---------|
| Input  | Green  | -             | Yellow       | Green | Green     | Green    | Green  | Green   |
| Output | Green  | -             | Green        | -     | Yellow    | Yellow   | Green  | -       |
| Alarm  | -      | -             | -            | Red   | Yellow    | Red      | Yellow | Yellow  |

## SDN-C Specifications (Single Phase)

| Description                       | Catalog Number   |  |
|-----------------------------------|--|--|
|                                   | SDN 5–24–100C  | SDN 10–24–100C                               |
| <b>Input</b>                      |  |  |
| Nominal Voltage                   | 115 - 230 Vac  |  |
| –AC Range                         | 85 - 264 Vac   |  |
| –DC Range <sup>1</sup>            | 90 - 375 Vdc   |  |
| –Frequency                        | 43 - 67 Hz   |  |
| Nominal Current <sup>2</sup>      | 1.65 - 0.55 A  | 3.2 - 1.0 A                                  |
| –Inrush current max.              | Typ. < 15 A  | Typ. < 30 A                                  |
| Efficiency (Losses <sup>3</sup> ) | > 88% typ. (14 W)  | > 90% typ. (24 W)                            |
| Power Factor Correction           | Active power factor correction to better than 0.92   |  |
| <b>Output</b>                     |  |  |
| Nominal Voltage <sup>4</sup>      | 24 V (23.5~28.5 Vdc Adj.)  |  |
| –Tolerance                        | < ±2 % overall (combination Line, load, time and temperature related changes)  |  |
| Initial Voltage Setting           | 24.5 V ± 1%  |  |
| –Ripple <sup>5</sup>              | < 50 mVpp  |  |
| PARD                              | PARD (Periodic and Random Deviation) = 100 mV peak-peak max  |  |
| Overvoltage Protection            | > 30.5 but < 33 Vdc, auto recovery   |  |
| Power Back Immunity               | < 35 V   |  |
| Nominal Current                   | 5 A (120 W)  | 10 A (240 W)                                 |
| –Peak Current <sup>6</sup>        | 1.5 x Nominal Current for 4 seconds minimum while holding voltage > 20 Vdc   |  |
| –Short Circuit Current            | 1.5 x Nominal Current at near zero volts at short circuit condition  |  |
| –Current Limit                    | PowerBoost™  |  |
| Parallel Operation                | Switch selectable single unit or parallel unit operation. Units will not be damaged by parallel operation (regardless of switch position setting).   |  |
| Holdup Time                       | >20 ms (Full load, 100 Vac Input @ T <sub>amb</sub> = +25°C) to 95% output voltage   |  |
| Voltage Fall Time                 | <150 mS from 95% to 10% rated voltage @ full load (T <sub>amb</sub> = +25°C)   |  |
| Line and Load Regulation          | < 0.5%   |  |
| <b>General</b>                    |  |  |
| EMC:<br>–Emissions                | EN61000-6-2:2001, EN61000-6-3:2001, Class B EN55011, EN55022 Radiated and Conducted including Annex. A, EN61000-3-2  |  |
| –Immunity                         | EN61000-6-1:2001, EN61000-6-2:2001, EN61000-4-2 Level 4, EN61000-4-3 Level 3, EN61000-4-6 Level 3, EN61000-4-4 Level 4 input and level 3 output. EN61000-4-5 Isolation class 4, EN61000-4-11, IEC 61000-4-34 voltage dip immunity standard   |  |
| Temperature <sup>7</sup>          | Storage: -40°C to + 85°C, Operation -25°C to +60°C full power, with linear derating to half power from 60 to 70°C (Convection cooling, no forced air required).<br>Operation up to 50% load permissible with sideways or front side up mounting orientation.   |  |
| MTBF <sup>8</sup>                 | > 550,000 hrs  |  |
| Warranty                          | 5 Year Limited Warranty  |  |
| General Protection/<br>Safety     | Protected against continuous short -circuit, continuous overload, continuous open circuit.<br>Protection Class 1 (IEC536), degree of protection IP20 (IEC60529) Safe low voltage: SELV (acc. IEC60950-1)   |  |
| Status Indicators                 | Visual: 3 status LEDs (Input, Output, Alarm)<br>Relay: N.O. contact rated 200ma/50 Vdc   |  |
| <b>Installation</b>               |  |  |
| Fusing –Input                     | Internally fused   |  |
| –Output                           | Outputs are capable of providing high currents for short periods of time for inductive load startup or switching. Fusing may be required for wire/loads if 2x Nominal O/P current rating cannot be tolerated. Continuous current overload allows for reliable fuse tripping.                           |  |
| Mounting                          | Simple snap-on to DIN TS35/7.5 or TS35/15 rail system.   |  |
| Connections                       | Input: Screw terminals, connector size range: 16-10 AWG (1.5-6 mm <sup>2</sup> ) for solid conductors. Screw torque: 4.4 lb-inch (~ 50 N-cm).<br>Output: Two terminals per output, connector size range: 16-10 AWG (1.5-6 mm <sup>2</sup> ) for solid conductors. Screw torque: 7 lb-inch (~ 80 N-cm). |  |
| Case                              | Fully enclosed metal housing with fine ventilation grid to keep out small parts.   |  |
| –Free Space                       | 25 mm above and below, 10 mm left and right, 15 mm in front  |  |
| H x W x D inches in (mm)          | 4.85 x 1.97 x 4.36<br>(123.0 x 50.0 x 110.0)   | 4.85 x 2.36 x 4.36<br>(123.0 x 60.0 x 110.0) |
| Weight lbs (kg)                   | 1.1 (0.50)   | 1.7 (0.80)                                   |

- Not UL listed for DC input.
- Input current ratings are conservatively specified with low input, worst case efficiency and power factor.
- Losses are heat dissipation in watts at full load, nominal input line.
- 24-28 Vdc adjustable guaranteed at full load.

- Ripple/noise is stated as typical values when measured with a 20 MHz, bandwidth scope and 50 Ohm resistor.
- Peak current is calculated at 24 Volt levels.
- Contact tech support for operation at -25°C.
- Demonstrated through extended life test.

## SDN-C Specifications (Single Phase)

| Description                       | Catalog Number  |   |
|-----------------------------------|---|---|
|                                   | SDN 20-24-100C  | SDN 40-24-100C  |
| <b>Input</b>                      |   |   |
| Nominal Voltage                   | 115 - 230 Vac   |   |
| -AC Range                         | 85 - 264 Vac  |   |
| -DC Range <sup>1</sup>            | 90 - 375 Vdc  |   |
| -Frequency                        | 43 - 67 Hz  |   |
| Nominal Current <sup>2</sup>      | 6 - 3 A   | 12 - 4 A  |
| -Inrush current max.              | < 40 A  | Typ. <60 A  |
| Efficiency (Losses <sup>3</sup> ) | > 92% (38 W)  | > 93 % (67 W)   |
| Power Factor Correction           | Active power factor correction to better than 0.92  |   |
| <b>Output</b>                     |   |   |
| Nominal Voltage <sup>4</sup>      | 24 V (23.5~28.5 Vdc Adj.)   |   |
| -Tolerance                        | < ±2 % overall (combination Line, load, time and temperature related changes)   |   |
| Initial Voltage Setting           | 24.5 V ± 1%   |   |
| -Ripple <sup>5</sup>              | <100 mVpp   | < 100 mVpp  |
| PARAD                             | PARAD (Periodic and Random Deviation) = 100 mV peak-peak max  |   |
| Overvoltage Protection            | > 30.5 but < 33 Vdc, auto recovery  |   |
| Power Back Immunity               | < 35 V  |   |
| Nominal Current                   | 20 A (480 W)  | 40 A (960 W)  |
| -Peak Current <sup>6</sup>        | 1.5 x Nominal Current for 4 seconds minimum while holding voltage > 20 Vdc  |   |
| -Short Circuit Current            | 1.5 x Nominal Current at near zero volts at short circuit condition   | 1.8 x Nominal Current at or near zero volts at short circuit condition  |
| -Current Limit                    | PowerBoost™   |   |
| Parallel Operation <sup>7</sup>   | Switch selectable single unit or parallel unit operation. Units will not be damaged by parallel operation (regardless of switch position setting).  | Active Paralleling  |
| Holdup Time                       | >20 mS (Full load, 100 Vac Input @ T <sub>amb</sub> = +25°C) to 95% output voltage  |   |
| Voltage Fall Time                 | <150 mS from 95% to 10% rated voltage @ full load (T <sub>amb</sub> = +25°C)  |   |
| Line and Load Regulation          | < 0.5%  |   |
| <b>General</b>                    |   |   |
| EMC:<br>-Emissions                | EN61000-6-2:2001, EN61000-6-3:2001, Class B EN55011, EN55022 Radiated and Conducted including Annex. A, EN61000-3-2   | EN61000-6-3, EN61000-6-4, Class B EN55011, EN55022 Radiated and Conducted including Annex A, EN61000-3-2, EN61000-3-3   |
| -Immunity                         | EN61000-6-1:2001, EN61000-6-2:2001, EN61000-4-2 Level 4, EN61000-4-3 Level 3, EN61000-4-6 Level 3, EN61000-4-4 Level 4 input and level 3 output. EN61000-4-5 Isolation class 4, EN61000-4-11, IEC 61000-4-34 voltage dip immunity standard  | EN61000-6-1, EN61000-6-2, EN61000-4-2 Level 4, EN61000-4-3 Level 3, EN61000-4-4 Level 4 input and Level 3 output, EN61000-4-5 Installation Class 4, EN61000-4-6 Level 3, EN61000-4-8, EN61000-4-11, SEMI F47 Sag Immunity, Transient protection according to VDE 0160/W2 over entire load range.        |
| Temperature <sup>8</sup>          | Storage: -40°C to + 85°C, Operation -25°C to +60°C full power, with linear derating to half power from 60 to 70°C (Convection cooling, no forced air required). Operation up to 50% load permissible with sideways or front side up mounting orientation.   |   |
| MTBF <sup>9</sup>                 | > 450,000 hrs   | > 500,000 hours demonstrated  |
| Warranty                          | 5 Year Limited Warranty   |   |
| General Protection/Safety         | Protected against continuous short -circuit, continuous overload, continuous open circuit. Protection Class 1 (IEC536), degree of protection IP20 (IEC60529) Safe low voltage: SELV (acc. IEC60950-1)   |   |
| Status Indicators                 | Visual: 3 status LEDs (Input, Output, Alarm)<br>Relay: N.O. contact rated 200ma/50 Vdc  |   |
| <b>Installation</b>               |   |   |
| Fusing -Input                     | Internally fused  |   |
| -Output                           | Outputs are capable of providing high currents for short periods of time for inductive load startup or switching. Fusing may be required for wire/loads if 2x Nominal O/P current rating cannot be tolerated. Continuous current overload allows for reliable fuse tripping.                        |   |
| Mounting                          | Simple snap-on to DIN TS35/7.5 or TS35/15 rail system.  |   |
| Connections <sup>10</sup>         | Input: Screw terminals, connector size range: 16-10 AWG (1.5-6 mm <sup>2</sup> ) for solid conductors. Screw Torque: 4.4 lb-in (~ 50 N-cm).<br>Output: Two terminals per output, connector size range: 16-10 AWG (1.5-6 mm <sup>2</sup> ) for solid conductors. Screw Torque: 7 lb-inch (~ 80 N-cm) | Input: Screw terminals, connector size range: 16-10 AWG (1.5-6 mm <sup>2</sup> ) for solid conductors. Screw Torque: 4.4 lb-inch (~ 50 N-cm).<br>Output: Two terminals per output, connector size range: 10-6 AWG (6-14 mm <sup>2</sup> ) for solid conductors. Screw Torque: 15.6 lb-inch (~ 176 N-cm) |
| Case                              | Fully enclosed metal housing with fine ventilation grid to keep out small parts.  |   |
| -Free Space                       | 25 - 40 mm above and below, 10 mm left and right, 15 mm in front  |   |
| H x W x D inches in (mm)          | 4.85 x 3.42 x 4.98 (123.0 x 87.0 x 127.0)   | 4.85 x 7.09 x 4.81 (123.0 x 180.0 x 122.0)  |
| Weight lbs (kg)                   | 2.6 (1.20)  | 6.0 (2.75)  |

1. Not UL listed for DC input.

2. Input current ratings are conservatively specified with low input, worst case efficiency and power factor.

3. Losses are heat dissipation in watts at full load, nominal input line.

4. 24-28 Vdc adjustable guaranteed at full load.

5. Ripple/noise is stated as typical values when measured with a 20 MHz, bandwidth scope and 50 Ohm resistor.

6. Peak current is calculated at 24 Volt levels.

7. All models except the 40amp unit are capable of parallel operation by use of a jumper pin, accessible by the end user. 40 amp unit will have active current sharing signal.

8. Contact tech support for operation at -25°C.

9. Demonstrated through extended life test.

10. SDN 40-24-100C only = Output signaling terminal block features (Shut down, Power Good, Current Monitor, Current Balance, signal GND).

SDN-C Specifications (Three Phase)

| Description                       | Catalog Number   |  |   |  |
|-----------------------------------|--|--|---|--|
|                                   | SDN 5-24-480C  | SDN 10-24-480C                               | SDN 20-24-480CC   | SDN 40-24-480C   |
| <b>Input</b>                      |  |  |   |  |
| Nominal Voltage                   | 380 - 480 Vac  |  |   |  |
| Two – phase input                 | Yes <sup>1</sup>   |  |   |  |
| –AC Range <sup>2</sup>            | 320 - 540 Vac  |  |   |  |
| –DC Range                         | 450 - 760 Vdc  | 450 - 760 Vdc                                | 450 - 760 Vdc <sup>10</sup>   | N/A  |
| –Frequency                        | 50/60 Hz   |  |   |  |
| Nominal Current <sup>3</sup>      | 3 x 0.5 or 2 x 0.7 A   | 3 x 0.8 or 2 x 1.2 A                         | 3 x 0.9 or 2 x 1.3 A  | 3 x 1.6 A  |
| –Inrush current max.              | Typ. <25 A   |  | Negligible  | Negligible   |
| Efficiency (Losses <sup>4</sup> ) | > 85% (18 W)   | 91.2% (23.6 W)                               | 93% (42 W)  | 94% (78 W)   |
| Power Factor Correction           | Power factor correction to meet EN61000-3-2 Class A  |  | Active Power Factor Correction  |  |
| <b>Output</b>                     |  |  |   |  |
| Turn on time                      | Typ. 1s  |  |   |  |
| Voltage Rise Time                 | ca. 5-20 ms  |  | <100 ms full resistive load (T <sub>amb</sub> = +25°C)                      |  |
| Power Back Immunity               | <35 V  |  |   |  |
| Overvoltage Protection            | >30.5 but <33 Vdc auto recovery  |  |   |  |
| Nominal Voltage <sup>5</sup>      | 24 V (23.5–28.5 Vdc Adj.)  |  |   |  |
| Voltage Regulation                | < ±2 % overall   |  |   |  |
| Initial Voltage Setting           | 24.5 V ± 1%  |  |   |  |
| –Ripple <sup>6</sup>              | <100 mVpp  |  |   |  |
| PARD                              | PARD = 100 mV peak-peak max  |  | PARD = 200 mV peak-peak max   |  |
| Nominal Current                   | 5 A (120 W)  | 10 A (240 W)                                 | 20 A (480 W) (constant power, not constant current)                         | 40 A (960 W)   |
| –Peak Current <sup>7</sup>        | 6A, 2xNominal Current <2sec  | 12A, 2xNominal Current <2sec                 | 1.5xNominal Current for 4 sec minimum while holding voltage > 20Vdc         |  |
| –Current Limit                    | PowerBoost™  |  |   |  |
| Derating                          | typ. 6 W/°C  | typ. 12 W/°C                                 | typ. 24 W/°C  | typ. 48 W/°C   |
| Holdup Time                       | >20 ms   |  | >15 ms  |  |
| Voltage Fall Time                 | <150 ms from 95% to 10% rated voltage @ full load (T <sub>amb</sub> = +25°C)   |  | <50 ms from 95% to 10% rated voltage @ full load (T <sub>amb</sub> = +25°C) |  |
| Parallel Operation <sup>8</sup>   | Single or Parallel operation selectable via front switch. For redundant operation, use of external diode module is preferred   |  |   | Active Paralleling                                     |
| <b>General</b>                    |  |  |   |  |
| Case                              | Fully enclosed metal housing with fine ventilation grid to keep out small parts.   |  |   |  |
| Min. Required                     | 25mm above and below or 15mm in front  | 25mm above and below or 10mm in front        | 70mm above and below or 25mm in front and 25mm left & right                 | 70mm above and below, 15mm in front, 25mm left & right |
| Free Space                        |  |  |   |  |
| HxWxD inches (mm)                 | 4.85 x 1.97 x 4.36<br>(123.0 x 50.0 x 111.0)   | 4.85 x 2.36 x 4.36<br>(123.0 x 60.0 x 111.0) | 4.85 x 3.35 x 4.68<br>(123.0 x 85.0 x 119.0)                                | 4.85 x 7.09 x 4.66<br>(123.0 x 180.0 x 119.0)          |
| Weight lbs (kg)                   | 1.2 (.52)  | 1.5 (0.70)                                   | 2.9 (1.30)  | 5.3 (2.40)   |
| EMC: –Emissions                   | EN61000-6-3:2001, Class B EN55011, EN55022 Radiated and Conducted including Annex. A, EN61000-3-2  |  |   |  |
| –Immunity                         | EN61000-6-1:2001, EN61000-6-2:2001, EN61000-4-2 Level 4, EN61000-4-3 Level 3, EN61000-4-6 Level 3, EN61000-4-4 Level 4 input and level 3 output, EN61000-4-5 Isolation class 4, EN61000-4-11   |  |   |  |
| Temperature                       | Storage : -40 to + 85°C, Operation -25 to +60°C full power, with linear derating to half power from 60 to 70°C (Convection cooling, no forced air required). Operation up to 50% load permissible with sideways or front side up mounting orientation. |  |   |  |
| Humidity                          | < 90% RH, noncondensing; IEC 60068-2-2, 68-2-3   |  |   |  |
| Altitude                          | 0 to 3000 meters (0 to 10,000 feet)  |  |   |  |
| Vibration                         | 2.5(g) RMS, 10-2000 Hz (random); three axes for 20 minutes each - IEC 60068-2-6  |  |   |  |
| Shock                             | 3(g) peak, three axes, 11mseconds for each axis - IEC 60068-2-27   |  |   |  |
| Warranty                          | 5 Year Limited Warranty  |  |   |  |
| MTBF                              | >500,000 hrs MTBF (Nominal voltage, full load, T <sub>amb</sub> = 25°C)  |  |   |  |
| General Protection/Safety         | Protected against short -circuit, overload, open circuit. Protection class 1 (IEC536), degree of protection IP20 (IEC 529)<br>Safe low voltage: SELV (acc. EN60950)  |  |   |  |
| Over-temperature protection       | LED Alarm, Output shutdown with automatic restart  |  |   |  |
| Status Indicators                 | Visual: 3 status LEDs (Input, Output, Alarm) Relay: SSR or dry relay contact, signal active when V <sub>out</sub> = 18.5 Vdc = +/-5%   |  |   |  |
| <b>Installation</b>               |  |  |   |  |
| Fusing: –Input                    | Externally fused   |  |   |  |
| –Output                           | Not fused. Output is capable of providing high currents (PowerBoost) for motor load startup.   |  |   |  |
| Mounting                          | Simple snap-on to DIN TS35/7.5 or TS35/15 rail system.<br>Unit should handle normal shock and vibration of industrial use and transportation without falling off the rail.   |  |   |  |

1. SDN 20 will operate at 75% load; SDN 40 will operate at 50% load under loss of 1 phase; SDN 5 and SDN 10 will operate with single phase input power at 100% of load. Unit will shut down if thermal threshold is exceeded under this condition.  
 2. Unit passed input voltage overstress test at 600 Vac without failure.  
 3. Input current ratings are specified with low input, line conditions, worst case efficiency values and power factor spikes. Input current at nominal input settings will typically be half these values.  
 4. Losses are heat dissipation in watts at full load, nominal line.  
 5. 24-28 Vdc adjustable guaranteed at full load.  
 6. Ripple/noise is stated as typical values when measured with a 20 MHz, bandwidth

scope and 50 Ohm resistor.  
 7. SDN 20 and 40 unit will go to HICCUP mode. SDN 5 and 10 will maintain min 4 secs to deliver 150% load then drops to almost zero V<sub>out</sub>. The output voltage will immediately drop to almost zero when load rises above 150%.  
 8. All models except the 40amp unit are capable of parallel operation by use of a jumper pin, accessible by the end user. 40 amp unit will have active current sharing signal.  
 9. SDN 40-24-100C only = Output signaling terminal block features (Shut down, Power Good, Current Monitor, Current Balance, signal GND).  
 10. 70% maximum rated load.

SDN-C Series Dimensions

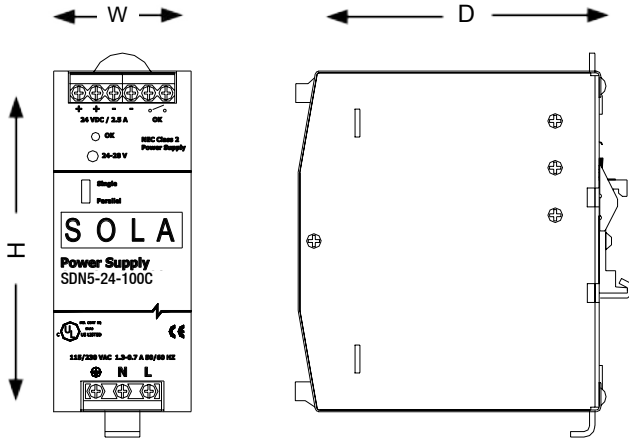

| Catalog Number  | Dimensions – inches (mm) |             |              |
|-----------------|--------------------------|-------------|--------------|
|                 | H                        | W           | D            |
| SDN 5–24–100C   | 4.85 (123.0)             | 1.97 (50.0) | 4.36 (111.0) |
| SDN 10–24–100C  | 4.85 (123.0)             | 2.36 (60.0) | 4.36 (111.0) |
| SDN 20–24–100C  | 4.85 (123.0)             | 3.42 (87.0) | 4.98 (127.0) |
| SDN 5–24–480C   | 4.85 (123.0)             | 1.97 (50.0) | 4.36 (111.0) |
| SDN 10–24–480C  | 4.85 (123.0)             | 2.36 (60.0) | 4.36 (111.0) |
| SDN 20–24–480CC | 4.85 (123.0)             | 3.35 (85.0) | 4.68 (119.0) |

SDN 40-24-100C and SDN 40-24-480C Dimensions

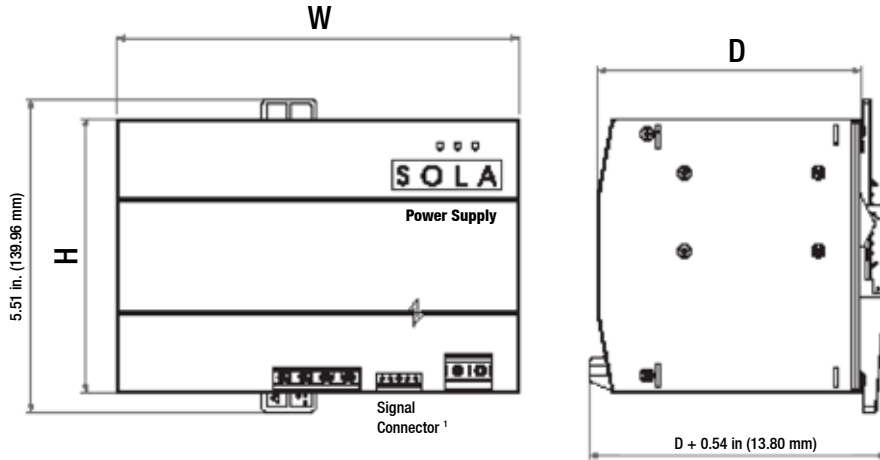

| Catalog Number | Dimensions – inches (mm) |              |              |
|----------------|--------------------------|--------------|--------------|
|                | H                        | W            | D            |
| SDN 40–24–100C | 4.85 (123.0)             | 7.09 (180.0) | 4.66 (118.0) |
| SDN 40–24–480C | 4.85 (123.0)             | 7.09 (180.0) | 4.81 (122.0) |

1. SDN 40-24-100C and SDN 40-24-480C output signaling terminal block features: Shut Down, Power Good, Current Monitor, Current Balance, GND, and active current sharing through I\_SHARE connectors (See Signals Manual for connection information).

### SDN-C Series Mounting

#### Chassis Mounting

Instead of snapping a SolaHD SDN™ unit on the DIN Rail, you can also attach it using the screw mounting set SDN-PMBRK2.

This set consists of two metal brackets, which replace the existing two aluminum profiles.

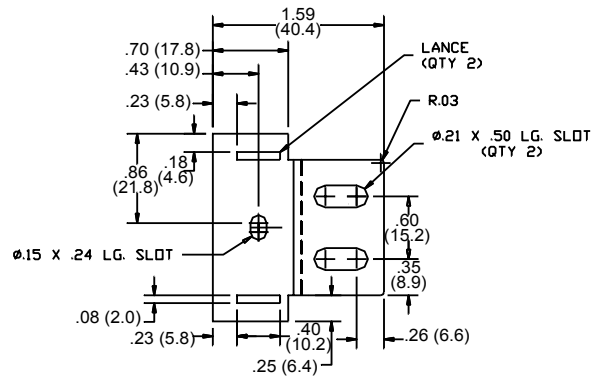

#### Dimensional Diagram - in (mm)

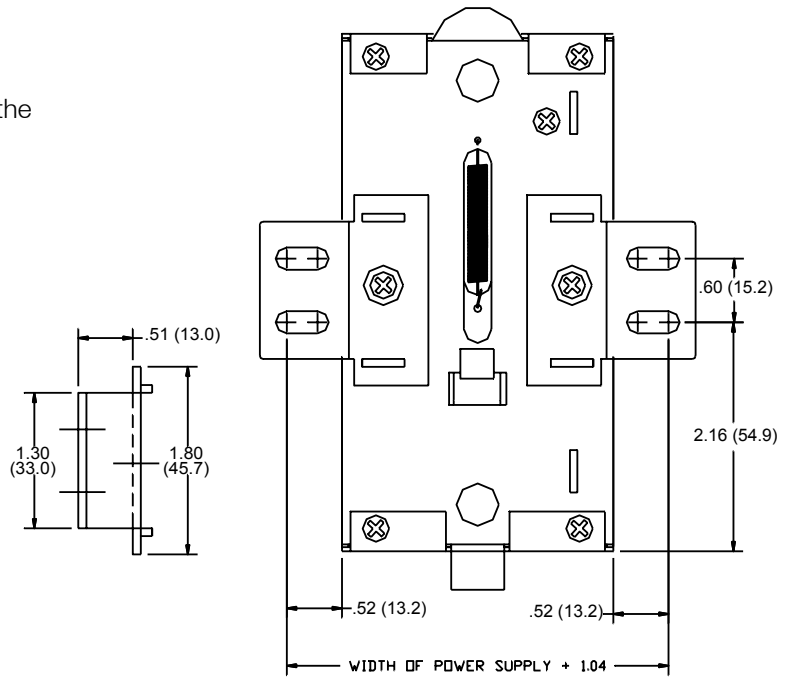

#### DIN Rail Mounting

Snap on the DIN Rail:

1. Tilt unit slightly backwards
2. Put it onto the DIN Rail
3. Push downwards until stopped
4. Push at the lower front edge to lock
5. Shake the unit slightly to ensure that the retainer has locked

Alternative Panel Mount: Using the optional SDN-PMBRK2 accessory, the unit can be screw mounted to a panel.

#### Detachment from DIN Rail:

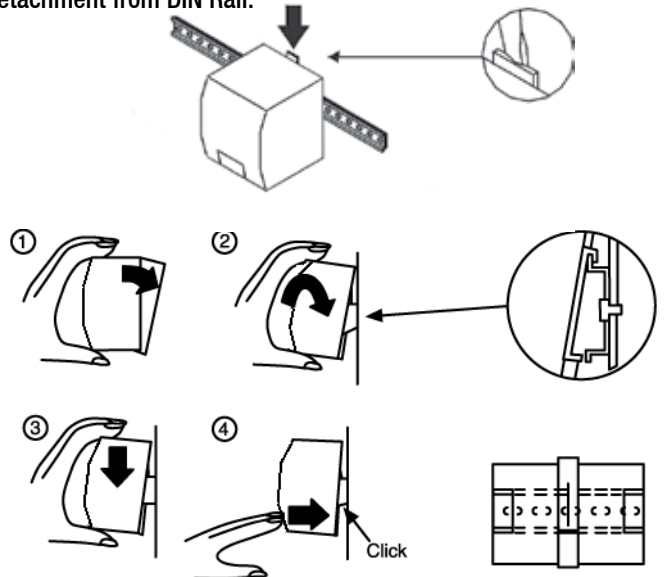



## SDN 40-24-100C Competitive Comparison

|   | SolaHD  | Phoenix  | Siemens   | PULS  | Allen Bradley   |
|---|---|--|---|---|---|
| <b>Part Number</b>                        | <b>SDN 40-24-100C</b>   | <b>QUINT-PS/ 1AC/24DC/40</b>   | <b>6EP1 337-3BA00</b>   | <b>QS40.241</b>   | <b>1606-XLS960EE</b>  |
| <b># of Conditions</b>                    | 8   | 4  | 3   | 3   | 2   |
| <b>Diagnostics</b>                        | Normal, AC Power Loss, AC Input Law, No DC, High Load, Overload, Hot, Too Hot         | IOUT < IN, IOUT > IN, VOUT < 0.9x VN, VOUT > 0.9x VN   | Normal, Yellow LED, for Overload, RED LED for latching shutdown | Normal, Overload, No DC output  | DC ON, DC OFF   |
| <b>Nominal Input Voltage</b>              | 100-240Vac  | 100-240Vac   | set by jumpers 85-132V/176-264V                                 | 100-240Vac  | 200-240Vac  |
| <b>AC Input Range</b>                     | 85-264Vac   | 85-264Vac  | 90-264Vac   | 90-264Vac   | 90-264Vac   |
| <b>Output Voltage</b>                     | 24 Vdc  | 24 Vdc   | 24 Vdc  | 24Vdc   | 24Vdc   |
| <b>Output Current</b>                     | @ 40amps  | @ 40amps   | @ 40amps  | @ 40Amps  | @ 40Amps  |
| <b>Output Voltage Adjustment Range</b>    | 23.5-28.5 Vdc adjustable  | 18-29.5 Vdc (> 24V constant capacity)  | 24-28.8 Vdc adjustable  | 24-28 Vdc adjustable  | 24-28 Vdc   |
| <b>Efficiency</b>                         | > 93% (67 W)  | >92 % (for 230Vac and nominal values)  | approx 88% (131 W)  | > 93.2%   | Typ. 94.6%  |
| <b>Mains Frequency</b>                    | 50 – 60 Hz  | 45 – 65 Hz   | 47 – 63 Hz  | 50 – 60 Hz +/-6%  | 50 – 60 Hz +/-6%  |
| <b>Reliability (MTBF)</b>                 | > 500,000 hrs   | > 500 000 h in acc. with IEC 61709 (SN 29500)  | Not published   | > 274,000 hr acc. to SN 29500, IEC 61709 at full load current and 40°C          | > 274,000 hr acc. to SN 29500, IEC 61709 at full load current and 40°C          |
| <b>Size (cm3 )</b>                        | 2712.1  | 5050.8   | 3750.3  | 1968.5  | 1968.5  |
| <b>Width along the DIN rail inch (mm)</b> | 7.09in (180mm)  | 7.09 in (180mm)  | 9.45 in (240mm)   | 4.92 in (125mm)   | 4.92 in (125mm)   |
| <b>Installation Clearance Required</b>    | 25 mm above and below, 25 mm left and right, 15 mm in front. Do not obstruct air flow | 50 mm vertically to ensure sufficient convection; 15 mm laterally required when installed next to other active components. | 50 mm above and below   | 40mm on top, 20mm on the bottom, 15 mm left and right, Do not obstruct air flow | 40mm on top, 20mm on the bottom, 15 mm left and right, Do not obstruct air flow |
| <b>Full Power Ambient</b>                 | -25°C to +60°C  | -25°C to + 60°C  | 0°C to + 70°C   | -25°C to + 70°C   | -25°C to + 70°C   |
| <b>Hazardous Location Rating</b>          | Class I, Division 2<br>Class I, Zone 2  | No rating  | No rating   | Class 1, Div 2 Pending  | Class I, Division 2   |
| <b>ATEX Rating</b>                        | Yes   | No rating  | Yes   | Pending   | No rating   |
| <b>Weight lb/kg</b>                       | 6.0lb (2.75kg)  | 7.2lb (3.3kg)  | 6.33lb (2.9kg)  | 4.2lb (1.9kg)   | 4.2lb (1.9kg)   |
| <b>Warranty</b>                           | 5 years   | 5 years  | Not published   | 3 years   | 1 year  |



# SolaHD SDN-C Series DIN Rail Power Supplies

Reliable delivery of power in a compact footprint  
for single- or three-phase input

SOLAHD



# SDN-C SERIES: SINGLE- AND THREE-PHASE POWER SUPPLIES

Maximize uptime and lower energy costs.

## The SolaHD SDN-C Series delivers:

Higher efficiency.

Improved visual diagnostics.

Greater reliability.

Compact size.

## Meet all your bulk power supply needs with a complete product line:

24 Vdc, DIN rail-mounted power supplies.

Single- and three-phase models.

New 40 Amp single-phase model.



# HIGHER EFFICIENCY

**Advanced SolaHD technology eliminates the need for an input inductor and provides more efficient AC/DC conversion.**

**Lower energy consumption.** A more efficient design helps reduce energy costs.

**Lower cooling costs.** With no input inductor, less energy is wasted in the form of dissipated heat – with no need for additional cooling fans in the panel.

**Longer life.** Less heat inside the panel enclosure means SDN-C power supplies and other components perform longer and more reliably.

# IMPROVED VISUAL DIAGNOSTICS

Multicolored LEDs show the status of input power, output power and alarm conditions at a glance.

|        | Normal | AC Power Loss | AC Input Loss | NO DC | High Load | Overload | Hot*   | Too Hot* |
|--------|--------|---------------|---------------|-------|-----------|----------|--------|----------|
| Input  | Green  | -----         | Yellow        | Green | Green     | Green    | Green  | Green    |
| Output | Green  | -----         | Green         | ----- | Yellow    | Yellow   | Green  | -----    |
| Alarm  | -----  | -----         | -----         | Red   | Yellow    | Red      | Yellow | Yellow   |

\* Hot and Too Hot indicate the unit is about to shut down due to high temperature or has shut down. Not intended to be used as a thermostat or to monitor temperature.

- **Reduce downtime.** Troubleshoot power supply problems quickly and confidently.
- **Diagnostic key.** Affix the included sticker to the power supply or panel door to provide a handy diagnostic reference.



# GREATER RELIABILITY

Count on an improved design and SolaHD manufacturing quality for dependable performance.

- **Reduced parts count.** Fewer components provide lower failure rates compared to more complex power supplies.
- **Less heat.** With no input inductor, the SDN-C Series is less prone to heat buildup that can damage components.
- **Smarter component layout.** Heat-sensitive components are placed near cool air intakes and away from heat-producing components.

# COMPACT SIZE

**SDN-C Series power supplies are smaller and more compact, so they are easier to work with and let you do more in the available space.**

- **More room to work.** SDN-C power supplies save space on the DIN rail and in the electrical enclosure, so it's easier to terminate wires and configure components.
- **Better heat dissipation.** With more space around individual components, air circulates more freely.
- **Increased enclosure capacity.** Add more components to increase the capacity and efficiency of your operations, while avoiding the need to add a new enclosure.



# NEW: 40 AMP POWER SUPPLY WITH SINGLE-PHASE INPUT

For industries located in buildings with single-phase power, there is no need to let power supply capacity limit what you can do.

Our newest single-phase SDN-C model delivers the same 40 Amp capacity as our largest three-phase model.

## **The power you need today.**

Run large industrial loads – such as sorting, conveying and packaging equipment, using the single-phase power available in any commercial building.

## **The power you need tomorrow.**

Add new equipment to your operation and get the power you need within your existing power structure – with little or no retrofitting required.

# NEW: 40 AMP POWER SUPPLY WITH SINGLE-PHASE INPUT

Single-phase power is by far the most commonly available. Even when industries require three-phase service to run large industrial motors, many branch circuits are likely to be on a single phase.

Our new 40 Amp, single-phase SDN-C transformer is a perfect fit for powering large DC loads on a standard, single-phase AC circuit.

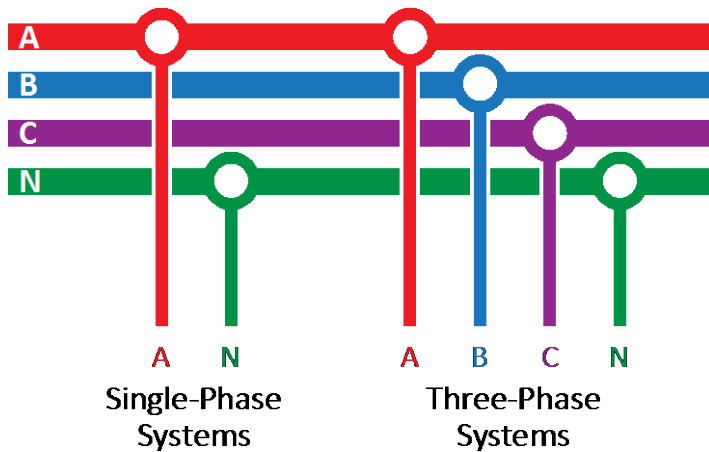



# SPECIFICATIONS/CERTIFICATIONS

## **Listed, Industrial Control Equipment, E61379**

- UL508, CSA C22.2 No. 107.1

## **UL Recognized Component, ITE, E137632**

- UL 60950-1/CSA C22.2 No. 60950-1, 2nd Edition

## **UL Recognized Component, Haz. Loc., E234790**

- UL 60079-15/CSA E60079-15
- Class I, Zone 2, AEx nC IIC, Ex nC IIC

## **Low Voltage Directive**

- IEC/ EN60950-1, 2nd Edition

## **Directive**

- EN60079-0, EN60079-15
- II 3 G, Ex nC IIC Gc

## **Sag Immunity: SEMI F47**

# CATALOG INFORMATION

## Product offering

| Single-Phase   |       |      |
|----------------|-------|------|
| Catalog Number | Watts | Amps |
| SDN 5-24-100C  | 120   | 5    |
| SDN 10-24-100C | 240   | 10   |
| SDN 20-24-100C | 480   | 20   |
| SDN 40-24-100C | 960   | 40   |

| Three-Phase     |       |      |
|-----------------|-------|------|
| Catalog Number  | Watts | Amps |
| SDN 5-24-480C   | 120   | 5    |
| SDN 10-24-480C  | 240   | 10   |
| SDN 20-24-480CC | 480   | 20   |
| SDN 40-24-480C  | 960   | 40   |

**For more information and to order your SDN-C power supply,  
contact your SolaHD representative.**

## WHY SOLAHD?

Since 1915 in the most demanding environments, SolaHD has supplied total power-quality solutions to keep production lines moving and people, equipment and information safe.

Turn to SolaHD for industrial-grade power conversion and power quality products to ensure reliable operation across your entire production environment.

Компания «Life Electronics» занимается поставками электронных компонентов импортного и отечественного производства от производителей и со складов крупных дистрибьюторов Европы, Америки и Азии.

С конца 2013 года компания активно расширяет линейку поставок компонентов по направлению коаксиальный кабель, кварцевые генераторы и конденсаторы (керамические, пленочные, электролитические), за счёт заключения дистрибьюторских договоров

Мы предлагаем:

- Конкуренспособные цены и скидки постоянным клиентам.
- Специальные условия для постоянных клиентов.
- Подбор аналогов.
- Поставку компонентов в любых объемах, удовлетворяющих вашим потребностям.
- Приемлемые сроки поставки, возможна ускоренная поставка.
- Доставку товара в любую точку России и стран СНГ.
- Комплексную поставку.
- Работу по проектам и поставку образцов.
- Формирование склада под заказчика.
- Сертификаты соответствия на поставляемую продукцию (по желанию клиента).
- Тестирование поставляемой продукции.
- Поставку компонентов, требующих военную и космическую приемку.
- Входной контроль качества.
- Наличие сертификата ISO.

В составе нашей компании организован Конструкторский отдел, призванный помогать разработчикам, и инженерам.

Конструкторский отдел помогает осуществить:

- Регистрацию проекта у производителя компонентов.
- Техническую поддержку проекта.
- Защиту от снятия компонента с производства.
- Оценку стоимости проекта по компонентам.
- Изготовление тестовой платы монтаж и пусконаладочные работы.



Тел: +7 (812) 336 43 04 (многоканальный)  
Email: [org@lifeelectronics.ru](mailto:org@lifeelectronics.ru)