

CGHV35400F

400 W, 2900 - 3500 MHz, 50-Ohm Input/Output Matched, GaN HEMT for S-Band Radar Systems

Cree's CGHV35400F is a gallium nitride (GaN) high electron mobility transistor (HEMT) designed specifically with high efficiency, high gain and wide bandwidth capabilities, which makes the CGHV35400F ideal for 2.9 - 3.5 GHz S-Band radar amplifier applications. The transistor is supplied in a ceramic/metal flange package, type 440210.

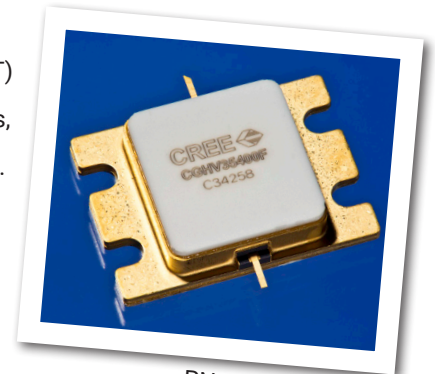

PN: CGHV35400F
Package Type: 440215

Typical Performance Over 2.9-3.5 GHz ($T_c = 85^\circ\text{C}$) of Demonstration Amplifier

Parameter	2.9 GHz	3.2 GHz	3.5 GHz	Units
Output Power	375	400	360	W
Gain	9.8	10	9.6	dB
Drain Efficiency	66	59	57	%

Note:

Measured in the CGHV35400F-AMP1 application circuit, under 500 μs pulse width, 10% duty cycle, $P_{IN} = 46$ dBm.

Features

- 2.9 - 3.5 GHz Operation
- 400 W Typical Output Power
- 10.5 dB Power Gain
- 60% Typical Drain Efficiency
- 50 Ohm Internally Matched
- <0.3 dB Pulsed Amplitude Droop

Large Signal Models Available for ADS and MWO

Absolute Maximum Ratings (not simultaneous)

Parameter	Symbol	Rating	Units	Conditions
Pulse Width	PW	500	μs	
Duty Cycle	DC	10	%	
Drain-Source Voltage	V_{DS}	125	Volts	25°C
Gate-to-Source Voltage	V_{GS}	-10, +2	Volts	25°C
Storage Temperature	T_{STG}	-65, +150	°C	
Operating Junction Temperature	T_J	225	°C	
Maximum Forward Gate Current	I_{GMAX}	80	mA	25°C
Maximum Drain Current ¹	I_{DMAX}	24	A	25°C
Soldering Temperature ²	T_S	245	°C	
Screw Torque	τ	40	in-oz	
Pulsed Thermal Resistance, Junction to Case	$R_{\theta JC}$	0.22	°C/W	100 μsec, 10%, 85°C, $P_{DISS} = 418$ W
Pulsed Thermal Resistance, Junction to Case	$R_{\theta JC}$	0.30	°C/W	500 μsec, 10%, 85°C, $P_{DISS} = 418$ W
Case Operating Temperature	T_C	-40, +85	°C	

Notes:

¹ Current limit for long term, reliable operation

² Refer to the Application Note on soldering at <http://www.cree.com/rf/tools-and-support/document-library>

Electrical Characteristics

Characteristics	Symbol	Min.	Typ.	Max.	Units	Conditions
DC Characteristics¹ ($T_C = 25^\circ\text{C}$)						
Gate Threshold Voltage	$V_{GS(th)}$	-3.8	-3.0	-2.3	V_{DC}	$V_{DS} = 10$ V, $I_D = 83.6$ mA
Gate Quiescent Voltage	$V_{GS(Q)}$	-	-2.7	-	V_{DC}	$V_{DS} = 45$ V, $I_D = 0.5$ A
Saturated Drain Current ²	I_{DS}	62.7	75.5	-	A	$V_{DS} = 6.0$ V, $V_{GS} = 2.0$ V
Drain-Source Breakdown Voltage	V_{BR}	150	-	-	V_{DC}	$V_{GS} = -8$ V, $I_D = 83.6$ mA

Notes:

¹ Measured on wafer prior to packaging.

² Scaled from PCM data.

Electrical Characteristics Continued...

Characteristics	Symbol	Min.	Typ.	Max.	Units	Conditions
RF Characteristics³ ($T_c = 85^\circ\text{C}$, $F_o = 2.9 - 3.5\text{ GHz}$ unless otherwise noted)						
Output Power at 2.9 GHz	P_{OUT1}	340	375	–	W	$V_{DD} = 45\text{ V}$, $I_{DQ} = 500\text{ mA}$, $P_{IN} = 46\text{ dBm}$
Output Power at 3.2 GHz	P_{OUT2}	340	400	–	W	$V_{DD} = 45\text{ V}$, $I_{DQ} = 500\text{ mA}$, $P_{IN} = 46\text{ dBm}$
Output Power at 3.5 GHz	P_{OUT3}	300	360	–	W	$V_{DD} = 45\text{ V}$, $I_{DQ} = 500\text{ mA}$, $P_{IN} = 46\text{ dBm}$
Gain at 2.9 GHz	G_{P1}	9.3	9.8	–	dB	$V_{DD} = 45\text{ V}$, $I_{DQ} = 500\text{ mA}$, $P_{IN} = 46\text{ dBm}$
Gain at 3.2 GHz	G_{P2}	9.3	10.0	–	dB	$V_{DD} = 45\text{ V}$, $I_{DQ} = 500\text{ mA}$, $P_{IN} = 46\text{ dBm}$
Gain at 3.5 GHz	G_{P3}	8.7	9.6	–	dB	$V_{DD} = 45\text{ V}$, $I_{DQ} = 500\text{ mA}$, $P_{IN} = 46\text{ dBm}$
Drain Efficiency at 2.9 GHz	D_{E1}	58	66	–	%	$V_{DD} = 45\text{ V}$, $I_{DQ} = 500\text{ mA}$, $P_{IN} = 46\text{ dBm}$
Drain Efficiency at 3.2 GHz	D_{E2}	53	59	–	%	$V_{DD} = 45\text{ V}$, $I_{DQ} = 500\text{ mA}$, $P_{IN} = 46\text{ dBm}$
Drain Efficiency at 3.5 GHz	D_{E3}	48	57	–	%	$V_{DD} = 45\text{ V}$, $I_{DQ} = 500\text{ mA}$, $P_{IN} = 46\text{ dBm}$
Small Signal Gain	S21	10.5	12	–	dB	$V_{DD} = 45\text{ V}$, $I_{DQ} = 500\text{ mA}$, $P_{IN} = -10\text{ dBm}$
Input Return Loss	S11	–	-8	-3.0	dB	$V_{DD} = 45\text{ V}$, $I_{DQ} = 500\text{ mA}$, $P_{IN} = -10\text{ dBm}$
Output Return Loss	S22	–	-8	-4.0	dB	$V_{DD} = 45\text{ V}$, $I_{DQ} = 500\text{ mA}$, $P_{IN} = -10\text{ dBm}$
Amplitude Droop	D	–	-0.3	–	dB	$V_{DD} = 45\text{ V}$, $I_{DQ} = 500\text{ mA}$, $P_{IN} = 46\text{ dBm}$
Output Stress Match	VSWR	–	5:1	–	Ψ	No damage at all phase angles, $V_{DD} = 45\text{ V}$, $I_{DQ} = 500\text{ mA}$, $P_{IN} = 46\text{ dBm}$ Pulsed

Notes:

³ Measured in CGHV35400F-AMP1. Pulse Width = 500 μs , Duty Cycle = 10%.

Electrostatic Discharge (ESD) Classifications

Parameter	Symbol	Class	Test Methodology
Human Body Model	HBM	1A (> 250 V)	JEDEC JESD22 A114-D
Charge Device Model	CDM	II (200 < 500 V)	JEDEC JESD22 C101-C

Typical Performance

Figure 1. - CGHV35400F Typical Sparameters
 $V_{DD} = 45\text{ V}$, $I_{DQ} = 0.5\text{ A}$

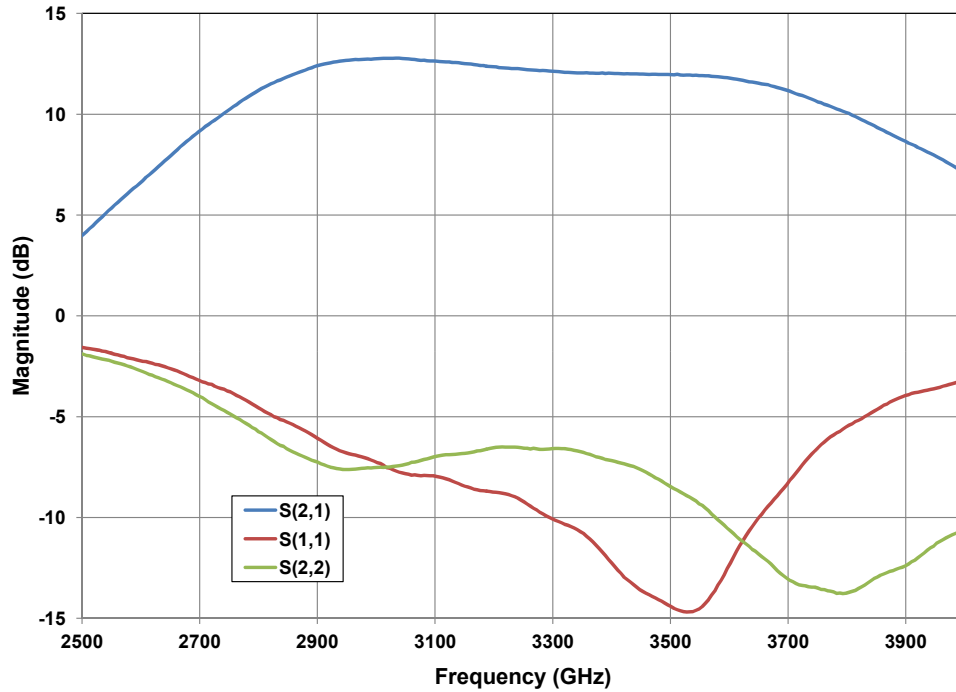
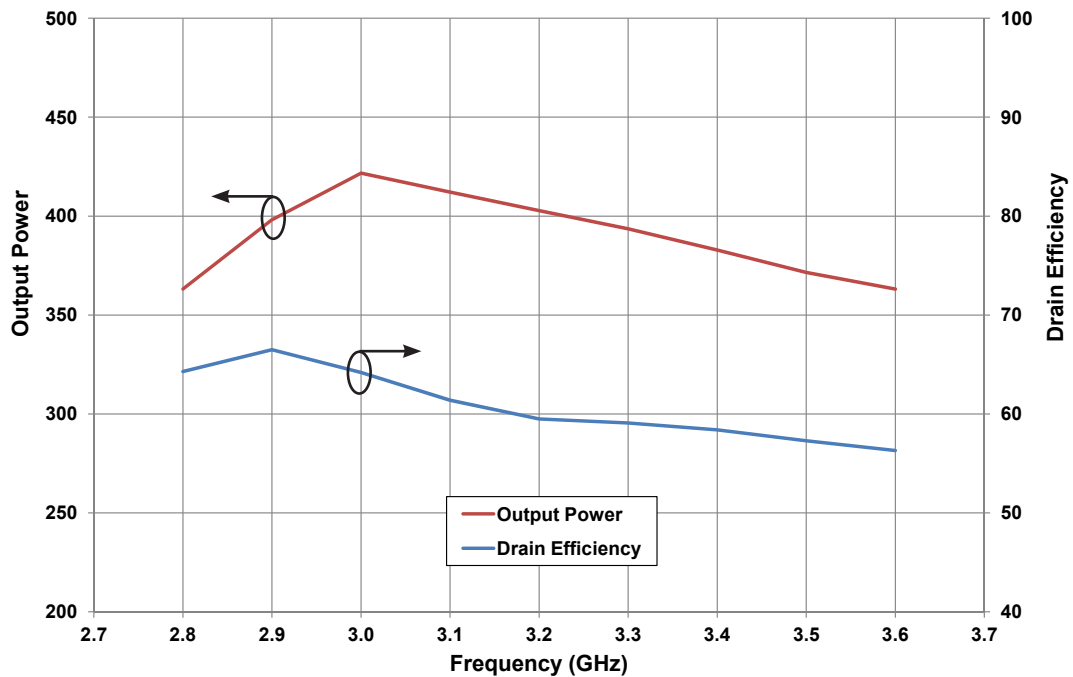

Figure 2. - CGHV35400F P_{OUT} and Drain Eff vs Frequency at $T_{CASE} = 85^\circ\text{C}$
 $V_{DD} = 45\text{ V}$, $I_{DQ} = 0.5\text{ A}$, $P_{IN} = 46\text{ dBm}$, Pulse Width = $500\mu\text{s}$, Duty Cycle = 10 %



Typical Performance

Figure 3. - CGHV35400F Output Power vs Input Power
 $V_{DD} = 45\text{ V}$, $I_{DQ} = 500\text{ mA}$, Pulse Width = $500\text{ }\mu\text{s}$, Duty Cycle = 10 %, $T_{case} = 85\text{ }^\circ\text{C}$

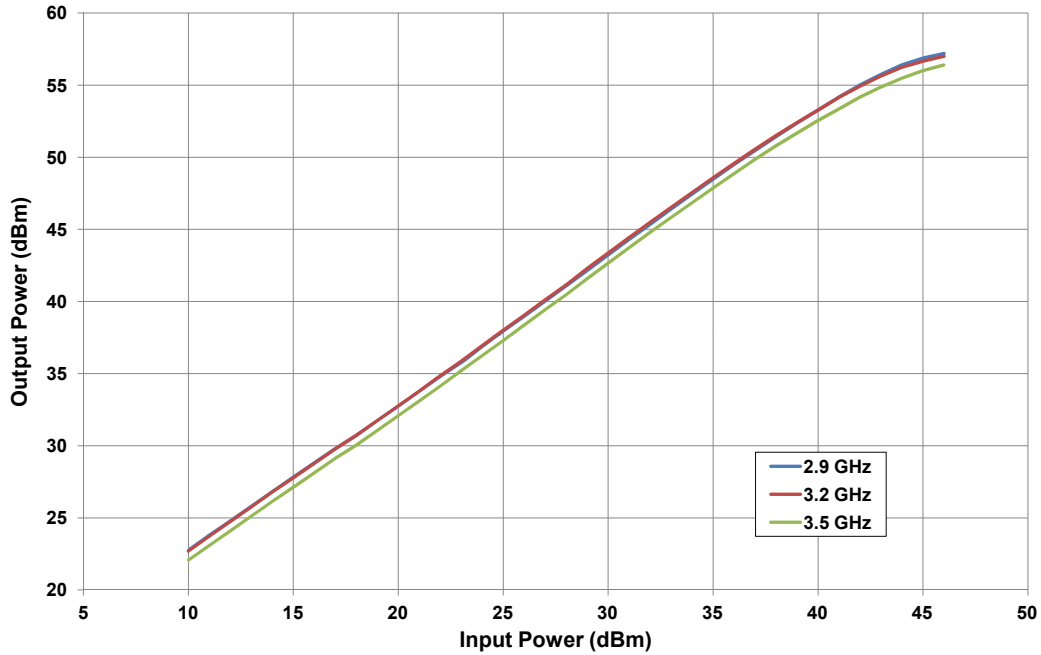
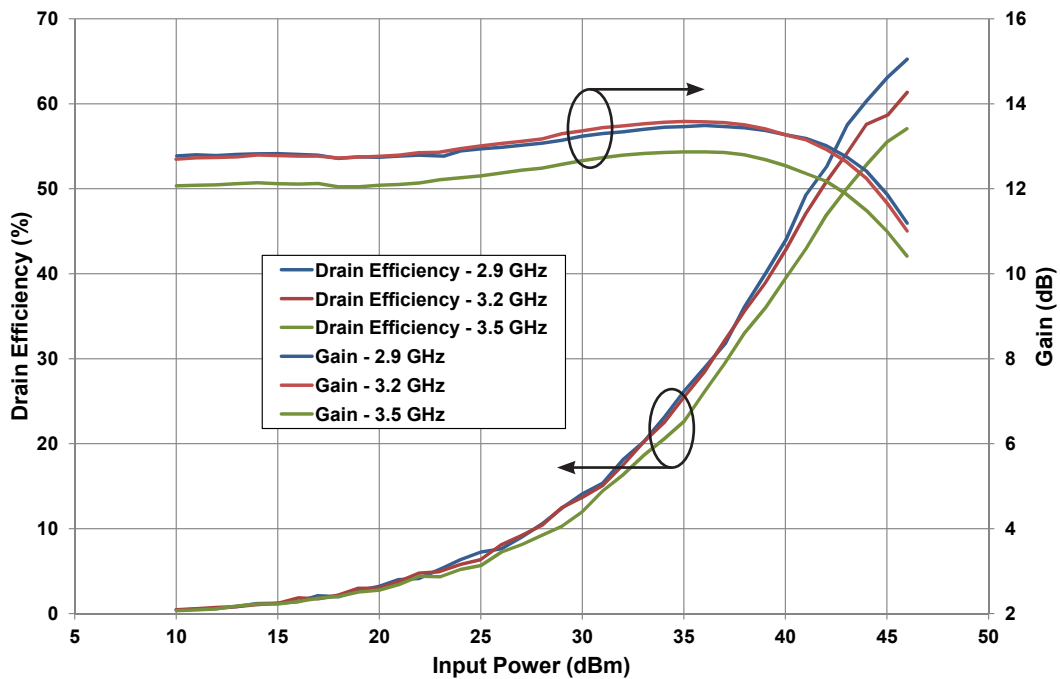

Figure 4. - CGHV35400F Drain Efficiency & Gain vs Input Power
 $V_{DD} = 45\text{ V}$, $I_{DQ} = 500\text{ mA}$, Pulse Width = $500\text{ }\mu\text{s}$, Duty Cycle = 10 %, $T_{case} = 85\text{ }^\circ\text{C}$



CGHV35400F-AMP1 Application Circuit Bill of Materials

Designator	Description	Qty
R1	RES, 511, OHM, +/- 1%, 1/16W, 0603	1
R2	RES, 5.1, OHM, +/- 1%, 1/16W, 0603	1
C1	CAP, 6.8pF, +/-0.25%, 250V, 0603	1
C2, C7, C8	CAP, 10.0pF, +/-1%, 250V, 0805	3
C3	CAP, 10.0pF, +/-5%, 250V, 0603	1
C4, C9	CAP, 470pF, 5%, 100V, 0603, X	2
C5	CAP, 33000 pF, 0805, 100V, X7R	1
C6	CAP, 10uF 16V TANTALUM	1
C10	CAP, 1.0uF, 100V, 10%, X7R, 1210	1
C11	CAP, 33uF, 20%, G CASE	1
C12	CAP, 3300uF, +/-20%, 100V, ELECTROLYTIC	1
J1,J2	CONN, SMA, PANEL MOUNT JACK, FL	2
J3	HEADER, RT>PLZ, 0.1CEN LK 9POS	1
J4	CONNECTOR, SMB, Straight, JACK, SMD	1
W1	CABLE, 18 AWG, 4.2	1
-	PCB, RO4350, 2.5 X 4.0 X 0.030	1
Q1	CGHV35400F	1

CGHV35400F Power Dissipation De-rating Curve

Figure 5. - CGHV35400F Transient Power Dissipation De-Rating Curve

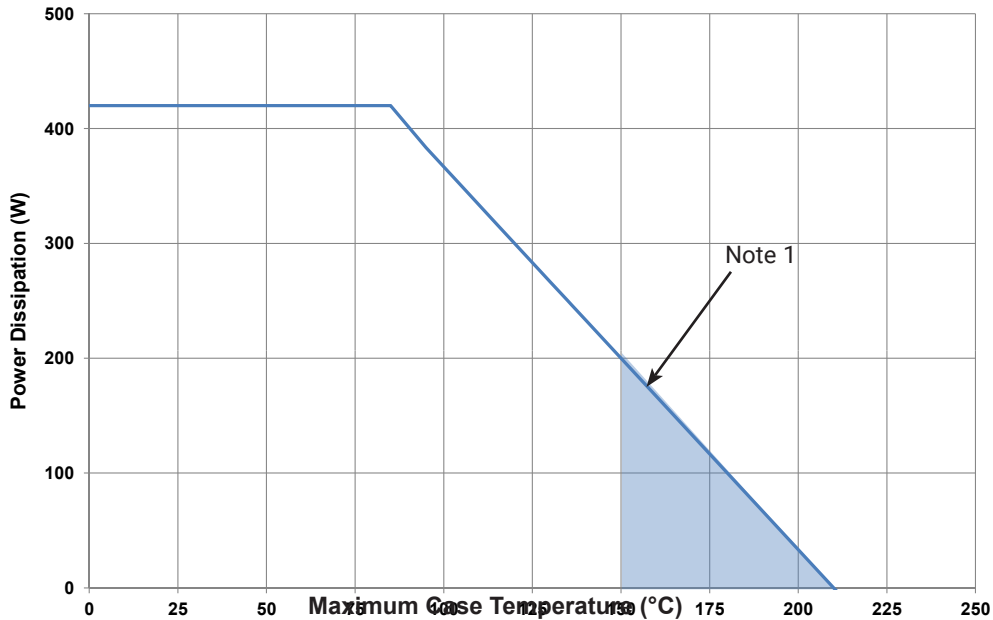

Note 1. Area exceeds Maximum Case Temperature (See Page 2).

CGHV35400F-AMP1 Application Circuit Outline

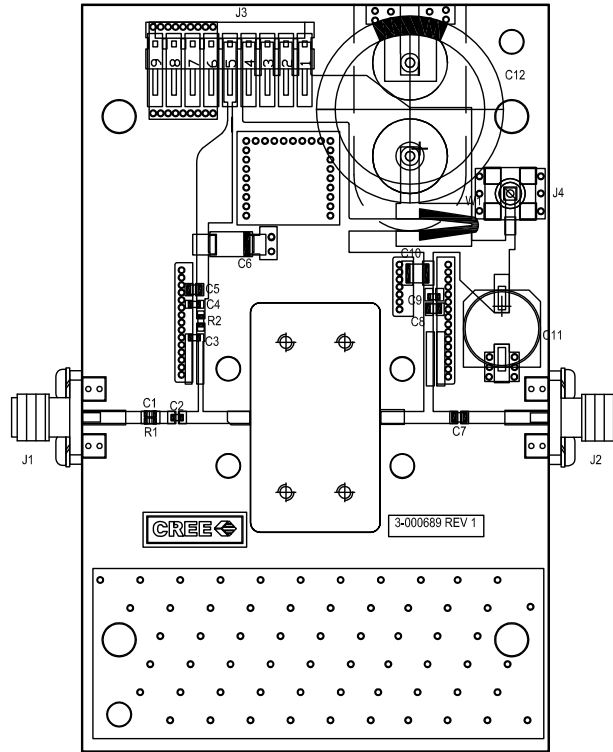

CGHV35400F-AMP1 Application Circuit Schematic

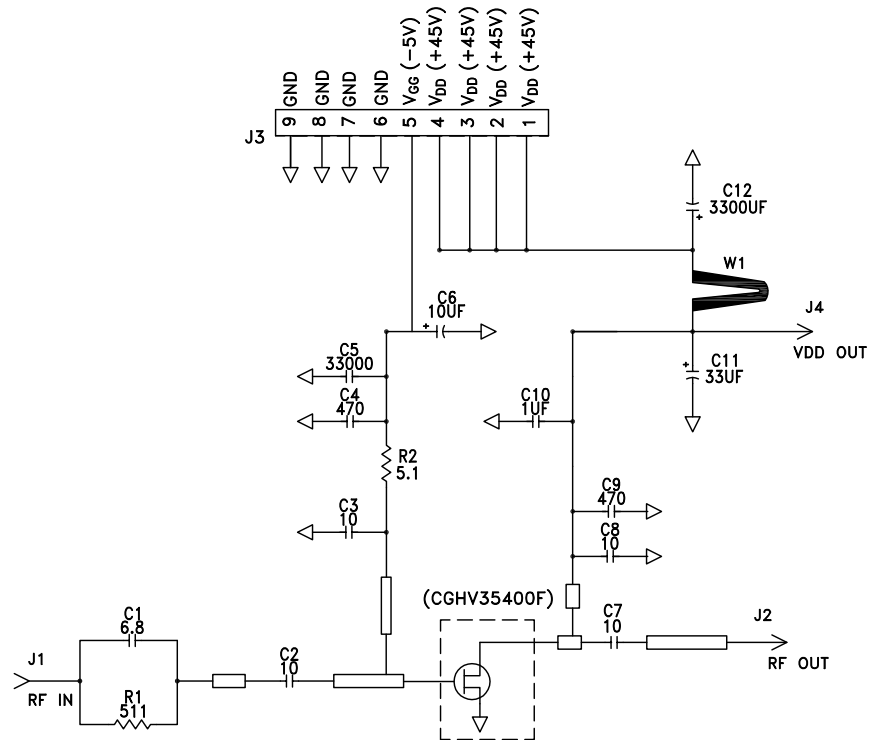

Product Dimensions CGHV35400F (Package Type – 440210)

NOTES: (UNLESS OTHERWISE SPECIFIED)

1. INTERPRET DRAWING IN ACCORDANCE WITH ANSI Y14.5M-2009
2. ADHESIVE FROM LID MAY EXTEND A MAXIMUM OF .020 BEYOND EDGE OF LID
3. LID MAY BE MISALIGNED TO THE BODY OF PACKAGE BY A MAXIMUM OF .008 IN ANY DIRECTION
4. ALL PLATED SURFACES ARE GOLD OVER NICKEL

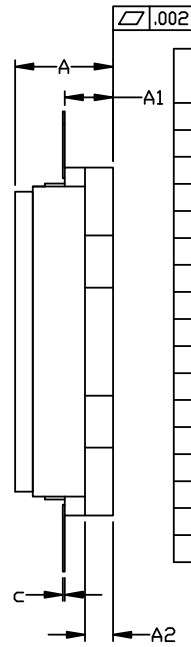
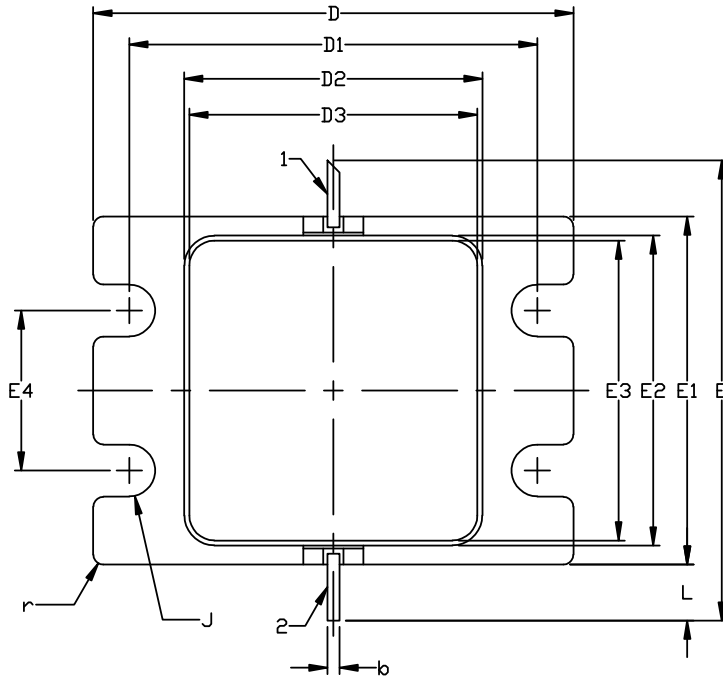

1. GATE
2. DRAIN

DIM	INCHES		MILLIMETERS		NOTES
	MIN	MAX	MIN	MAX	
A	0.188	0.198	4.78	5.03	
A1	0.088	0.100	2.24	2.54	2x
A2	0.049	0.061	1.24	1.55	
b	0.022	0.026	0.56	0.66	2x
c	0.002	0.006	0.05	0.15	
D	0.935	0.955	23.75	24.26	
D1	0.797	0.809	20.24	20.55	2x
D2	0.581	0.593	14.76	15.06	
D3	0.563	0.571	14.30	14.50	
E	0.906		23.01		REF
E1	0.679	0.691	17.25	17.55	
E2	0.604	0.616	15.34	15.65	
E3	0.586	0.594	14.88	15.09	
E4	0.309	0.321	7.85	8.15	2x
J	∅0.097	∅0.107	∅2.46	∅2.72	4x
L	0.090	0.130	2.29	3.30	2x
r	0.02	TYP	0.51	TYP	12x

CGHV35400F

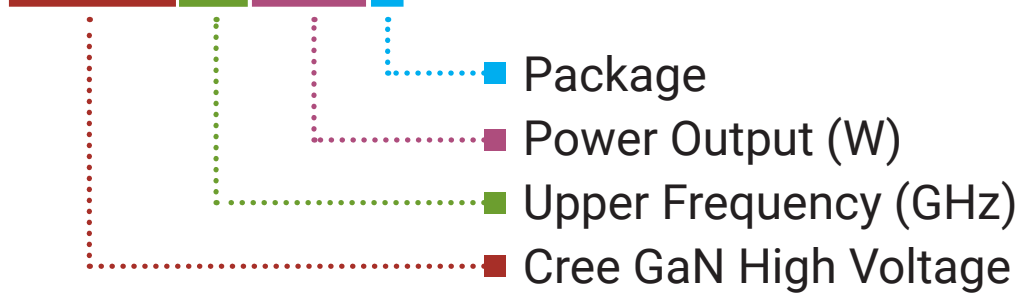

Parameter	Value	Units
Upper Frequency ¹	3.5	GHz
Power Output	400	W
Package	Flange	-

Table 1.

Note¹: Alpha characters used in frequency code indicate a value greater than 9.9 GHz. See Table 2 for value.

Character Code	Code Value
A	0
B	1
C	2
D	3
E	4
F	5
G	6
H	7
J	8
K	9
Examples:	1A = 10.0 GHz 2H = 27.0 GHz

Table 2.

Product Ordering Information

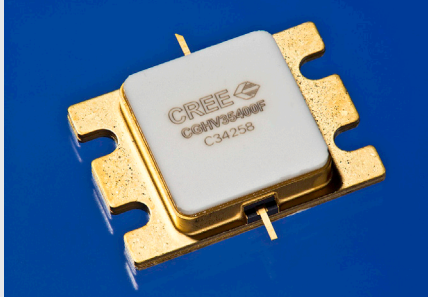
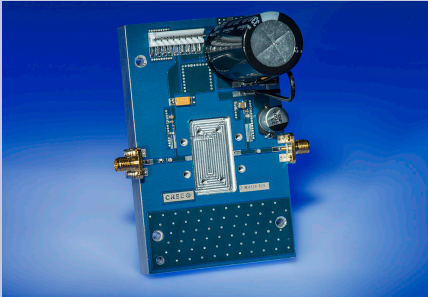
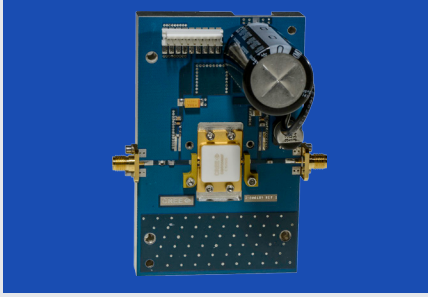
Order Number	Description	Unit of Measure	Image
CGHV35400F	GaN HEMT	Each	
CGHV35400F-TB	Test board without GaN HEMT	Each	
CGHV35400F-AMP1	Test board with GaN HEMT installed	Each	



Disclaimer

Specifications are subject to change without notice. Cree, Inc. believes the information contained within this data sheet to be accurate and reliable. However, no responsibility is assumed by Cree for any infringement of patents or other rights of third parties which may result from its use. No license is granted by implication or otherwise under any patent or patent rights of Cree. Cree makes no warranty, representation or guarantee regarding the suitability of its products for any particular purpose. "Typical" parameters are the average values expected by Cree in large quantities and are provided for information purposes only. These values can and do vary in different applications and actual performance can vary over time. All operating parameters should be validated by customer's technical experts for each application. Cree products are not designed, intended or authorized for use as components in applications intended for surgical implant into the body or to support or sustain life, in applications in which the failure of the Cree product could result in personal injury or death or in applications for planning, construction, maintenance or direct operation of a nuclear facility.

For more information, please contact:

Cree, Inc.
4600 Silicon Drive
Durham, North Carolina, USA 27703
www.cree.com/rf

Sarah Miller
Marketing
Cree, RF Components
1.919.407.5302

Ryan Baker
Marketing & Sales
Cree, RF Components
1.919.407.7816

Tom Dekker
Sales Director
Cree, RF Components
1.919.407.5639

Компания «Life Electronics» занимается поставками электронных компонентов импортного и отечественного производства от производителей и со складов крупных дистрибьюторов Европы, Америки и Азии.

С конца 2013 года компания активно расширяет линейку поставок компонентов по направлению коаксиальный кабель, кварцевые генераторы и конденсаторы (керамические, пленочные, электролитические), за счёт заключения дистрибьюторских договоров

Мы предлагаем:

- Конкурентоспособные цены и скидки постоянным клиентам.
- Специальные условия для постоянных клиентов.
- Подбор аналогов.
- Поставку компонентов в любых объемах, удовлетворяющих вашим потребностям.
- Приемлемые сроки поставки, возможна ускоренная поставка.
- Доставку товара в любую точку России и стран СНГ.
- Комплексную поставку.
- Работу по проектам и поставку образцов.
- Формирование склада под заказчика.
- Сертификаты соответствия на поставляемую продукцию (по желанию клиента).
- Тестирование поставляемой продукции.
- Поставку компонентов, требующих военную и космическую приемку.
- Входной контроль качества.
- Наличие сертификата ISO.

В составе нашей компании организован Конструкторский отдел, призванный помогать разработчикам, и инженерам.

Конструкторский отдел помогает осуществить:

- Регистрацию проекта у производителя компонентов.
- Техническую поддержку проекта.
- Защиту от снятия компонента с производства.
- Оценку стоимости проекта по компонентам.
- Изготовление тестовой платы монтаж и пусконаладочные работы.



Тел: +7 (812) 336 43 04 (многоканальный)
Email: org@lifeelectronics.ru