

Main

| | |
|------------------------------|---|
| Range of product | Altistart 22 |
| Product or component type | Soft starter |
| Product destination | Asynchronous motors |
| Product specific application | Pumps and fans |
| Component name | ATS22 |
| Phase | 3 phases |
| [Us] rated supply voltage | 230...600 V - 15...10 % |
| Motor power kW | 160 kW 400 V 160 kW 440 V 220 kW 500 V 90 kW 230 V |
| Factory setting current | 302 A |
| Power dissipation in W | 150 W for standard applications |
| Utilisation category | AC-53A |
| Type of start | Start with torque control (current limited to 3.5 In) |
| IcL starter rating | 320 A connection in the motor supply line for standard applications |
| IP degree of protection | IP00 |

Complementary

| | |
|------------------------------|--|
| Assembly style | With heat sink |
| Function available | Internal bypass |
| Supply voltage limits | 195...660 V |
| Supply frequency | 50...60 Hz - 10...10 % |
| Network frequency | 45...66 Hz |
| Device connection | In the motor supply line |
| [Uc] control circuit voltage | 230 V -15...10 % 50/60 Hz |
| Control circuit consumption | 20 W |
| Discrete output number | 2 |
| Discrete output type | Relay outputs R1 230 V running, alarm, trip, stopped, not stopped, starting, ready C/O Relay outputs R2 230 V running, alarm, trip, stopped, not stopped, starting, ready C/O |
| Minimum switching current | 100 mA 12 V DC relay outputs |
| Maximum switching current | 5 A 250 V AC resistive 1 relay outputs 5 A 30 V DC resistive 1 relay outputs 2 A 250 V AC inductive 0.4 20 ms relay outputs 2 A 30 V DC inductive 7 ms relay outputs |
| Discrete input number | 3 |
| Discrete input type | Logic LI1, LI2, LI3 5 mA 4.3 kOhm |
| Discrete input voltage | 24 V <= 30 V |
| Discrete input logic | Positive logic LI1, LI2, LI3 < 5 V and <= 2 mA > 11 V >= 5 mA |
| Output current | 0.4...1 Icl adjustable |
| PTC probe input | 750 Ohm |
| Communication port protocol | Modbus |
| Connector type | 1 RJ45 |
| Communication data link | Serial |
| Physical interface | RS485 multidrop |
| Transmission rate | 4800, 9600 or 19200 bps |
| Installed device | 31 |
| Protection type | Thermal protection motor |

The information provided in this documentation contains general descriptions and/or technical characteristics of the performance of the products contained herein. This documentation is not intended as a substitute for and is not to be used for determining suitability or reliability of these products for specific user applications. It is the duty of any such user or integrator to perform the appropriate and complete risk analysis, evaluation and testing of the products with respect to the relevant specific application or use thereof. Neither Schneider Electric Industries SAS nor any of its affiliates or subsidiaries shall be responsible or liable for misuse of the information contained herein.

| | |
|--------------------|---|
| | Phase failure line Thermal protection starter |
| Marking | CE |
| Type of cooling | Forced convection |
| Operating position | Vertical +/- 10 degree |
| Height | 16.73 in (425 mm) |
| Width | 8.11 in (206 mm) |
| Depth | 11.77 in (299 mm) |
| Product weight | 72.75 lb(US) (33 kg) |
| Power range | 55...100 kW at 200...240 V 3 phases 110...220 kW at 380...440 V 3 phases 110...220 kW at 480...500 V 3 phases |
| Motor starter type | Soft starter |

Environment

| | |
|---------------------------------------|--|
| electromagnetic compatibility | Conducted and radiated emissions level A IEC 60947-4-2 Damped oscillating waves level 3 IEC 61000-4-12 Electrostatic discharge level 3 IEC 61000-4-2 Immunity to electrical transients level 4 IEC 61000-4-4 Immunity to radiated radio-electrical interference level 3 IEC 61000-4-3 Voltage/current impulse level 3 IEC 61000-4-5 |
| standards | EN/IEC 60947-4-2 |
| product certifications | CCC CSA C-Tick GOST UL |
| vibration resistance | 1 gn 13...200 Hz EN/IEC 60068-2-6 1.5 mm 2...13 Hz EN/IEC 60068-2-6 |
| shock resistance | 15 gn 11 ms EN/IEC 60068-2-27 |
| noise level | 56 dB |
| pollution degree | Level 2 IEC 60664-1 |
| relative humidity | 0...95 % without condensation or dripping water EN/IEC 60068-2-3 |
| ambient air temperature for operation | 14...104 °F (-10...40 °C) without derating > 104...< 140 °F (> 40...< 60 °C) with current derating 2.2 % per °C |
| ambient air temperature for storage | -13...158 °F (-25...70 °C) |
| operating altitude | <= 3280.84 ft (1000 m) without derating > 3280.84...< 6561.68 ft (> 1000...< 2000 m) with current derating of 2.2 % per additional 100 m |

Offer Sustainability

| | |
|--|--|
| Green Premium product | Green Premium product |
| Compliant - since 0939 - Schneider Electric declaration of conformity | Compliant - since 0939 - Schneider Electric declaration of conformity |
| Reference not containing SVHC above the threshold | Reference not containing SVHC above the threshold |
| Available | Available |
| Available | Available |
| WARNING: This product can expose you to chemicals including: | WARNING: This product can expose you to chemicals including: |
| Lead and lead compounds, which is known to the State of California to cause cancer and birth defects or other reproductive harm. | Lead and lead compounds, which is known to the State of California to cause cancer and birth defects or other reproductive harm. |
| Bisphenol A (BPA), which is known to the State of California to cause birth defects or other reproductive harm. | Bisphenol A (BPA), which is known to the State of California to cause birth defects or other reproductive harm. |
| For more information go to www.p65warnings.ca.gov | For more information go to www.p65warnings.ca.gov |

Contractual warranty

| | |
|-----------------|-----------|
| Warranty period | 18 months |
|-----------------|-----------|

Frame Size D

Dimensions

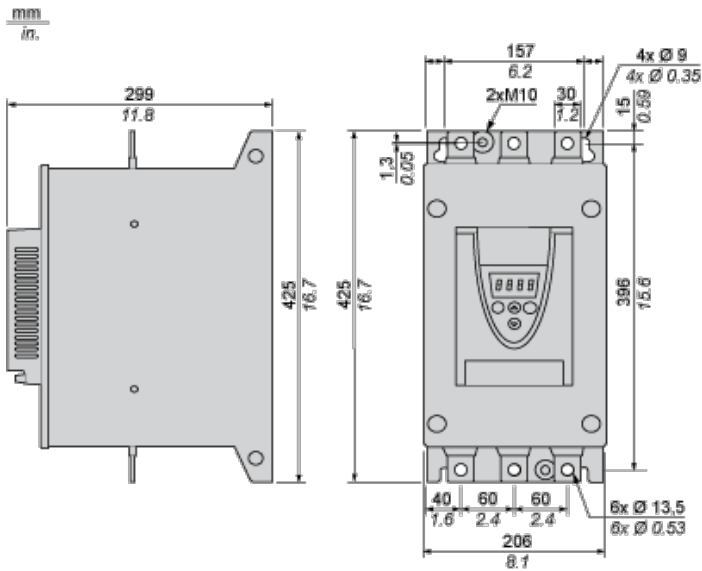

Precautions

Standards

The Altistart 22 soft starter is compliant with pollution Degree 2 as defined in NEMA ICS1-1 or IEC 60664-1.

For environment pollution degree 3, install the Altistart 22 soft starter inside a cabinet type 12 or IP54.

⚠ DANGER

HAZARD OF ELECTRIC SHOCK, EXPLOSION, OR ARC FLASH

ATS22 soft starters are open devices and must be mounted in a suitable enclosure.

Failure to follow these instructions will result in death or serious injury.

Air Circulation

Leave sufficient free space to help the air required for cooling purposes to circulate from the bottom to the top of the unit.

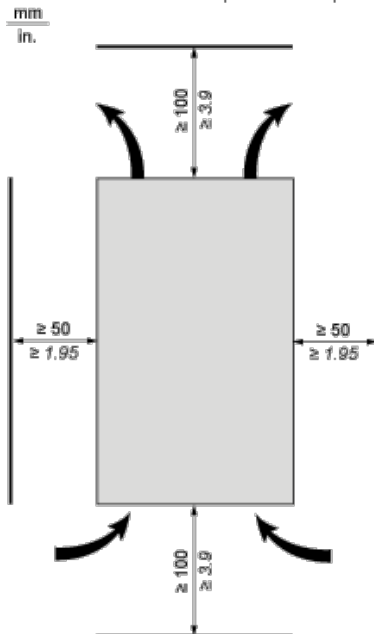

Overheating

To avoid the soft starter to overheat, respect the following recommendations:

- 1 Mount the Altistart 22 Soft Starter within $\pm 10^\circ$ of vertical.
- 1 Do not locate the Altistart 22 Soft Starter near heat radiating elements.
- 1 Electrical current through the Altistart 22 Soft Starter will result in heat losses that must be dissipated into the ambient air immediately surrounding the soft starter. To help prevent a thermal fault, provide sufficient enclosure cooling and/or ventilation to limit the ambient temperature around the soft starter.

- 1 If several soft starters are installed in a control panel, arrange them in a row. Do not stack soft starters. Heat generated from the bottom soft starter can adversely affect the ambient temperature around the top soft starter.

Wall mounted or Floor-standing Enclosure with IP 23 Degree of protection

Introduction

To help proper air circulation in the soft starter, grilles and forced ventilation can be installed.

Ventilation Grilles



Forced Ventilation Unit

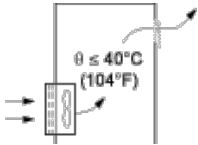

Power Terminal

Bar Style

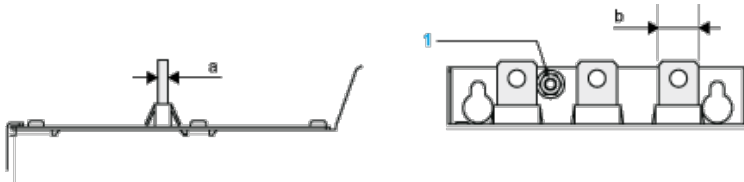

| | | | |
|----------------------------------|----------------------------|-------------------|------------------------|
| Power supply and output to motor | Bar | b | 30 mm (1.18 in) |
| | | a | 5 mm (0.2 in) |
| | | Bolt | M12 (0.47 in) |
| | Cable and protective cover | Size | 2X150 mm ² |
| | | Gauge | 2X250 MCM |
| | | Protective cover | LA9F703 |
| | | Tightening torque | 57 N.m 498.75 lb.in |

Power connections, minimum required wiring section

| IEC cable mm ² (Cu 70°C/158°F) (1) | UL cable AWG (Cu 75°C/167°F) (1) |
|--|-------------------------------------|
| 185 | 2 X 3/0 |

230 Vac control, logic Inputs (LI) 24 Vdc, 3-wire control

With Line Contactor, Freewheel or Controlled Stop

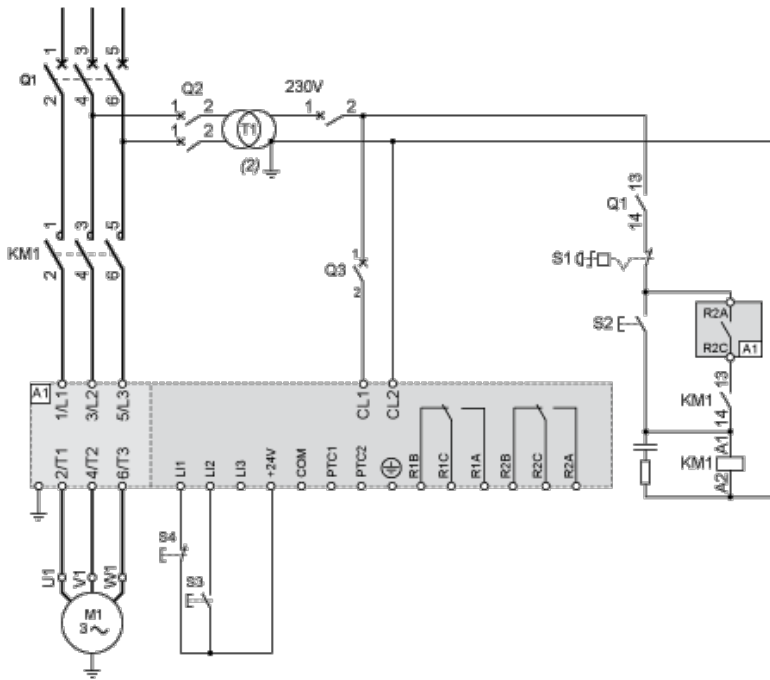

230 Vac control, logic Inputs (LI) 24 Vdc, 2-wire control, freewheel stop

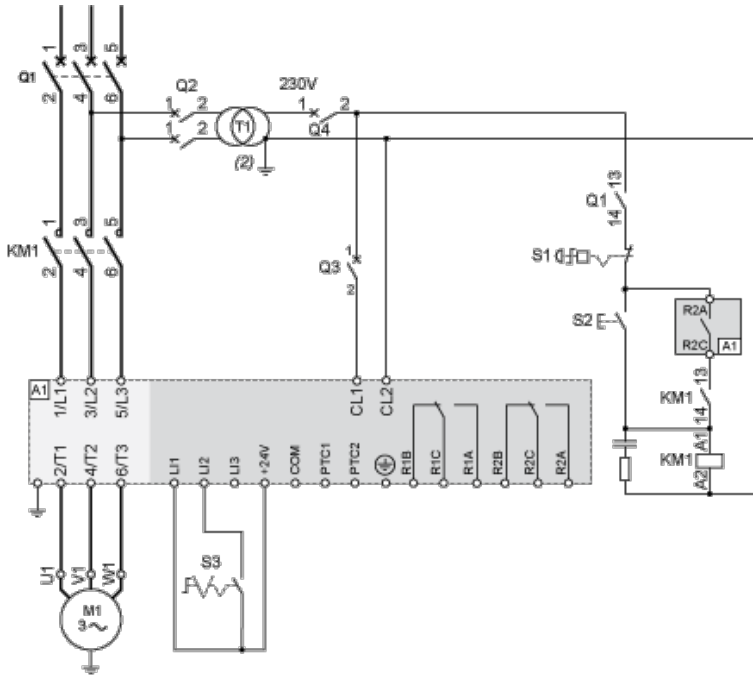

Motor Thermal Protection - Cold Curves

Curves

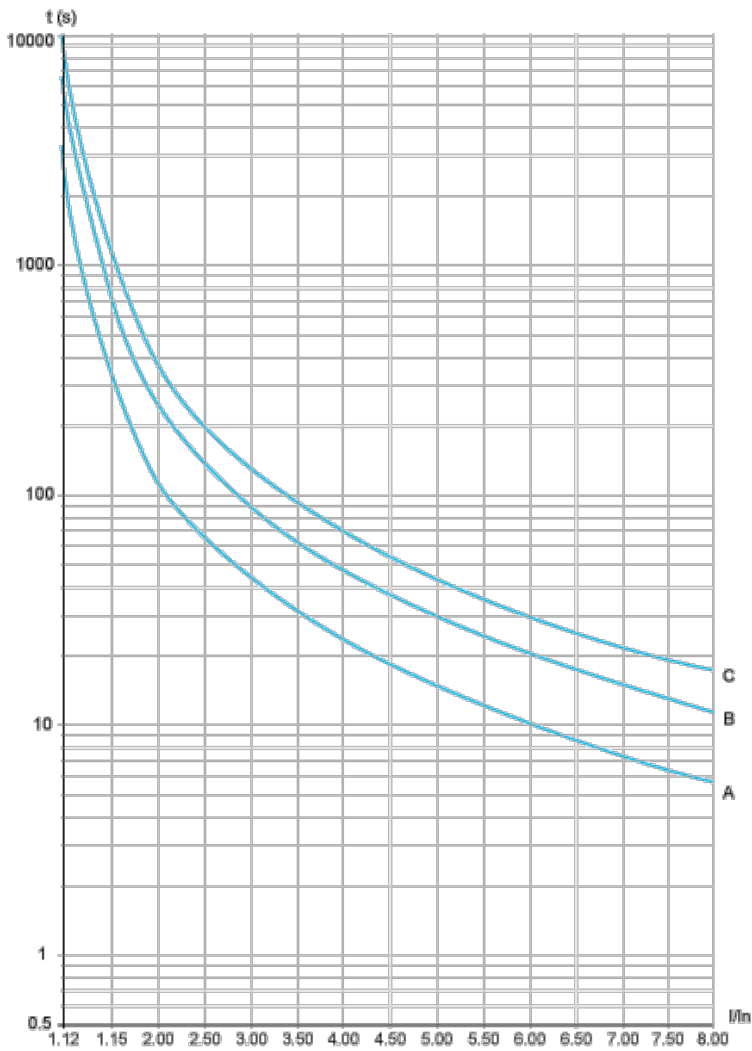

- A Class 10
- B Class 20
- C Class 30

Trip time for a Standard Application (Class 10)

3.5 In
32 s

Trip time for a Severe Application (Class 20)

3.5 In
63 s

Trip time for a Severe Application (Class 30)

3.5 In
95 s

Motor Thermal Protection - Warm Curves

Curves

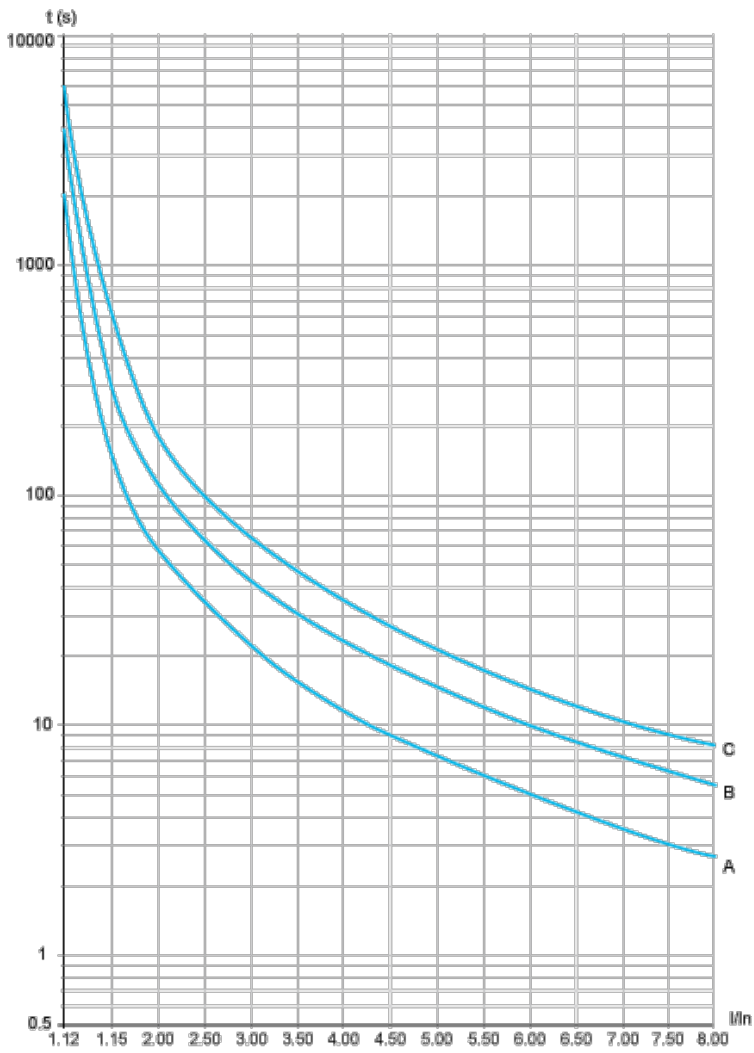

- A Class 10
- B Class 20
- C Class 30

Trip time for a Standard Application (Class 10)

3.5 In
16 s

Trip time for a Severe Application (Class 20)

3.5 In
32 s

Trip time for a Severe Application (Class 30)

3.5 In
48 s

Компания «Life Electronics» занимается поставками электронных компонентов импортного и отечественного производства от производителей и со складов крупных дистрибьюторов Европы, Америки и Азии.

С конца 2013 года компания активно расширяет линейку поставок компонентов по направлению коаксиальный кабель, кварцевые генераторы и конденсаторы (керамические, пленочные, электролитические), за счёт заключения дистрибьюторских договоров

Мы предлагаем:

- Конкуренспособные цены и скидки постоянным клиентам.
- Специальные условия для постоянных клиентов.
- Подбор аналогов.
- Поставку компонентов в любых объемах, удовлетворяющих вашим потребностям.
- Приемлемые сроки поставки, возможна ускоренная поставка.
- Доставку товара в любую точку России и стран СНГ.
- Комплексную поставку.
- Работу по проектам и поставку образцов.
- Формирование склада под заказчика.
- Сертификаты соответствия на поставляемую продукцию (по желанию клиента).
- Тестирование поставляемой продукции.
- Поставку компонентов, требующих военную и космическую приемку.
- Входной контроль качества.
- Наличие сертификата ISO.

В составе нашей компании организован Конструкторский отдел, призванный помогать разработчикам, и инженерам.

Конструкторский отдел помогает осуществить:

- Регистрацию проекта у производителя компонентов.
- Техническую поддержку проекта.
- Защиту от снятия компонента с производства.
- Оценку стоимости проекта по компонентам.
- Изготовление тестовой платы монтаж и пусконаладочные работы.



Тел: +7 (812) 336 43 04 (многоканальный)

Email: org@lifeelectronics.ru