

MLX90640 32x24 IR array

Datasheet

1. Features and Benefits

- Small size, low cost 32x24 pixels IR array
- Easy to integrate
- Industry standard four lead TO39 package
- Factory calibrated
- Noise Equivalent Temperature Difference (NETD) 0.1K RMS @1Hz refresh rate
- I²C compatible digital interface
- Programmable refresh rate 0.5Hz...64Hz
- 3.3V supply voltage
- Current consumption less than 23mA
- 2 FOV options – 55°x35° and 110°x75°
- Operating temperature -40°C ÷ 85°C
- Target temperature -40°C ÷ 300°C
- Complies with RoHS regulations

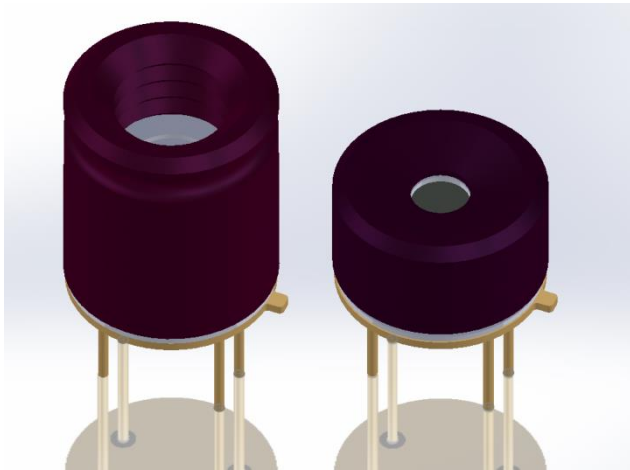

2. Application Examples

- High precision non-contact temperature measurements
- Intrusion / Movement detection
- Presence detection / Person localization
- Temperature sensing element for intelligent building air conditioning
- Thermal Comfort sensor in automotive Air Conditioning control system
- Microwave ovens
- Industrial temperature control of moving parts
- Visual IR thermometers
- Driver software for MCU available at: <https://github.com/melexis/mlx90640-library.git>

3. Description

The MLX90640 is a fully calibrated 32x24 pixels thermal IR array in an industry standard 4-lead TO39 package with digital interface.

The MLX90640 contains 768 FIR pixels. An ambient sensor is integrated to measure the ambient temperature of the chip and supply sensor to measure the VDD. The outputs of all sensors IR, Ta and VDD are stored in internal RAM and are accessible through I²C.

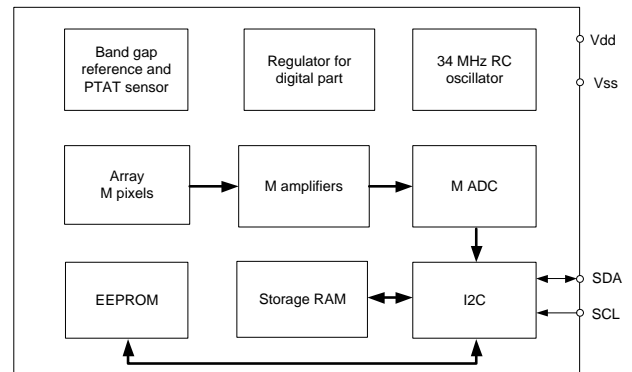

Figure 1 Block diagram

Contents

1. Features and Benefits.....	1
2. Application Examples.....	1
3. Description	1
4. Ordering Information	6
5. Glossary of Terms.....	7
6. Pin Definitions and Descriptions	8
7. Absolute Maximum Ratings	8
8. General Electrical Specifications	9
9. False pixel correction.....	10
10. Detailed General Description.....	10
10.1. Pixel position	10
10.2. Communication protocol	11
10.2.1. Low level	11
10.3. Measurement mode	12
10.4. Refresh rate.....	12
10.5. Measurement flow	13
10.6. Reading patterns.....	14
10.7. Address map	16
10.7.1. Internal registers.....	16
10.7.2. RAM	18
10.7.3. EEPROM	19
11. Calculating Object Temperature	22
11.1. Restoring calibration data from EEPROM	22
11.1.1. Restoring the VDD sensor parameters	22
11.1.2. Restoring the Ta sensor parameters	22
11.1.3. Restoring the offset	23
11.1.4. Restoring the Sensitivity $\alpha_{i,j}$	24
11.1.5. Restoring the $K_v(i,j)$ coefficient.....	25
11.1.6. Restoring the $K_{ta}(i,j)$ coefficient	25
11.1.7. Restoring the GAIN coefficient (common for all pixels)	26
11.1.8. Restoring the K_{sTa} coefficient (common for all pixels)	26

11.1.9. Restoring corner temperatures (common for all pixel).....	26
11.1.10. Restoring the KsTo coefficient (common for all pixels).....	27
11.1.11. Restoring sensitivity correction coefficients for each temperature range	27
11.1.12. Restoring the Sensitivity α_{CP}	28
11.1.13. Restoring the offset of the Compensation Pixel (CP)	28
11.1.14. Restoring the Kv CP coefficient.....	28
11.1.15. Restoring the Kta CP coefficient	28
11.1.16. Restoring the TGC coefficient	29
11.1.17. Restoring the resolution control coefficient.....	29
11.2. Temperature Calculation.....	30
11.2.1. Example Input Data	30
11.2.2. Temperature calculation	35
12. Performance graphs	47
12.1. Accuracy	47
12.1.1. Pixel accuracy.....	47
12.1.2. Ta accuracy	48
12.2. Startup time	49
12.2.1. First valid data.....	49
12.2.2. Thermal behavior.....	49
12.3. Noise performance and resolution.....	50
12.4. Field of view (FOV).....	52
13. Application information.....	53
13.1. Optical considerations.....	53
13.2. Electrical considerations	53
13.3. Using the device in “image mode”	54
14. Application Comments	55
15. Mechanical drawings.....	56
15.1. FOV 55°	56
15.2. FOV 110°	57
15.3. Device marking	58
16. Standard Information	59
17. ESD Precautions.....	59
18. Revision history table	59

19. Contact.....	60
20. Disclaimer.....	60

Tables

Table 1 Ordering information.....	6
Table 2 Glossary of terms.....	7
Table 3 Pin definition.....	8
Table 4 Absolute maximum ratings	8
Table 5 Electrical specification	9
Table 6 Priorities of subpage controls (0x0800D).....	17
Table 7 Configuration parameters memory	19
Table 8 EEPROM to registers mapping.....	19
Table 9 EEPROM overview (words).....	20
Table 10 Calibration parameters memory (EEPROM - bits).....	21
Table 11 Calculation example input data	30
Table 12 Calculation example calibration data.....	34
Table 13 XOR truth table.....	42
Table 14 Noise performance	51
Table 15 Available FOV options	52

Figures

Figure 1 Block diagram.....	1
Figure 2 MLX90640 Overview and pin description	8
Figure 3 Pixel in the whole FOV.....	10
Figure 4 I ² C write command format (default SA=0x33 is used)	11
Figure 5 I ² C read command format (default SA=0x33 is used)	11
Figure 6 Refresh rate timing.....	12
Figure 7 Recommended measurement flow	13
Figure 8 TV mode reading pattern (only highlighted cells are updated)	15
Figure 9 Chess reading pattern (only highlighted cells are updated)	15
Figure 10 MLX90640 memory map.....	16
Figure 11 Status register (0x8000) bits meaning	16
Figure 12 Control register1 (0x800D) bits meaning	17
Figure 13 I ² C configuration register (0x800F) bits meaning	18
Figure 14 RAM memory map (Chess pattern mode) – factory default mode.....	18
Figure 15 RAM memory map (Interleaved mode)	18
Figure 16 To calculation flow	35
Figure 17 Absolute temperature accuracy – MLX90640BAA (left) and MLX90640BAB (right)	47
Figure 19 MLX90640BAx noise vs refresh rate for different device types.....	50
Figure 20 MLX90640BAA noise vs pixel and refresh rate at 1Hz and 2Hz	50
Figure 21 MLX90640BAA noise vs pixel and refresh rate at 4Hz, 8Hz and 16Hz	50
Figure 22 MLX90640BAB noise vs pixel and refresh rate at 1Hz and 2Hz	51
Figure 23 MLX90640BAB noise vs pixel and refresh rate at 4Hz, 8Hz and 16Hz.....	51
Figure 24 Field Of View measurement.....	52

Figure 26 MLX90640 electrical connections53

Figure 27 Calculation flow in thermal image mode54

Figure 28 Mechanical drawing of 55° FOV device.....56

Figure 29 Mechanical drawing of 110° FOV device.....57

4. Ordering Information

Product	Temperature	Package	Option Code	Custom Configuration	Packing Form	Definition
MLX90640	E	SF	BAA	000	TU	32x24 IR array
MLX90640	E	SF	BAB	000	TU	32x24 IR array

Legend:

Temperature Code:	E: -40°C to 85°C
Package Code:	“SF” for TO39 package
Option Code:	xAx – TGC is disabled and may not be changed
Option Code:	xxA – FOV = 110°x75° xxB – FOV = 55°x35°
Custom configuration	000 – standard product
Packing Form:	“TU” - Tubes
Ordering Example:	“MLX90640ESF-BAA-000-TU”

Table 1 Ordering information

5. Glossary of Terms

TC	Temperature Coefficient (in ppm/°C)
POR	Power On Reset
IR	Infra-Red
Ta	Ambient Temperature – the temperature of the TO39 package
IR data	Infrared data (raw data from ADC proportional to IR energy received by the sensor)
ADC	Analog To Digital Converter
TGC	Temperature Gradient Coefficient
FOV	Field Of View
nFOV	Field Of View of the N-th pixel
I ² C	Inter-Integrated Circuit communication protocol
SDA	Serial Data
SCL	Serial Clock
LSB	Least Significant Bit
MSB	Most Significant Bit
Fps	Frames per Second – data refresh rate
MD	Master Device
SD	Slave Device
ASP	Analog Signal Processing
DSP	Digital Signal Processing
ESD	Electro Static Discharge
EMC	Electro Magnetic Compatibility
CP	Compensation Pixel
NC	Not Connected
NA	Not Applicable
TBD	To Be Defined

Table 2 Glossary of terms

6. Pin Definitions and Descriptions

Pin #	Name	Description
1	SDA	I ² C serial data (input / output)
2	VDD	Positive supply
3	GND	Negative supply (Ground)
4	SCL	I ² C serial clock (input only)

Table 3 Pin definition

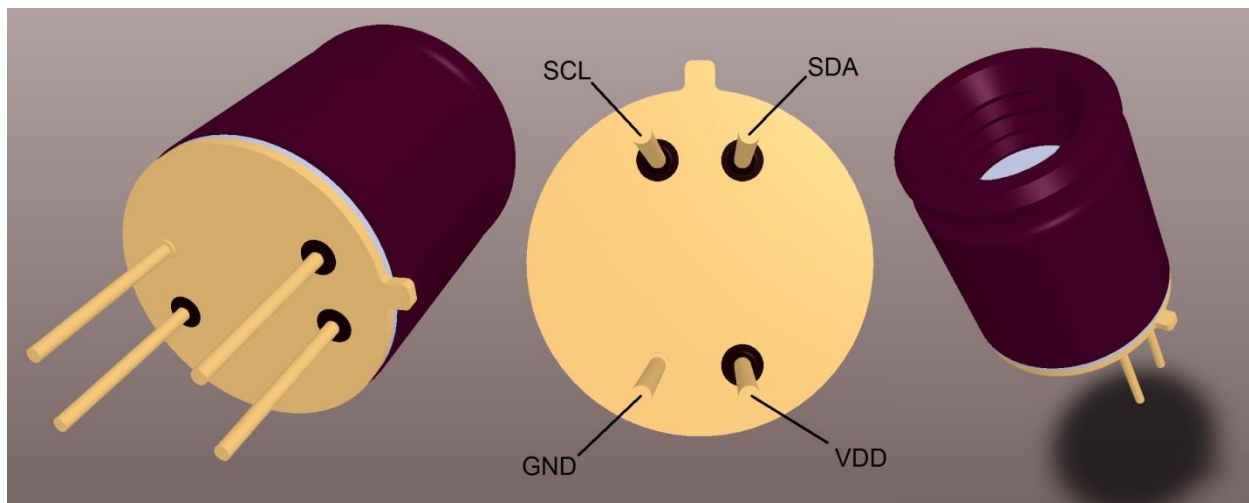

Figure 2 MLX90640 Overview and pin description

7. Absolute Maximum Ratings

Parameter	Symbol	Min.	Typ.	Max.	Unit	Remark
Supply Voltage (over voltage)	V _{DD}			5	V	
Supply Voltage (operating max voltage)	V _{DD}			3.6		
Reverse Voltage (each pin)				-0.3	V	
Operating Temperature	T _{AMB}	-40		+85	°C	
Storage Temperature	T _{ST}	-40		+85	°C	Not in plastic tubes
ESD sensitivity (AEC Q100 002)		4			kV	
SDA DC sink current				40	mA	

Table 4 Absolute maximum ratings

Exceeding the absolute maximum ratings may cause permanent damage. Exposure to absolute maximum-rated conditions for extended periods may affect device reliability.

8. General Electrical Specifications

Electrical Parameter	Symbol	Min.	Typ.	Max.	Unit	Condition
Supply Voltage	V _{DD}	3	3.3	3.6	V	
Supply Current	I _{DD}	15	20	25	mA	
POR level up analog	V _{POR_UP}	2.2		2.6	V	VDD rising
POR level down analog	V _{POR_DOWN}			2.55	V	VDD falling
POR hysteresis	V _{POR_hys}		50		mV	
I ² C address ^(NOTE 3)		0x01	0x33(default)	0xFF		
Input high voltage (SDA, SCL)	V _{IH}	0.7*V _{DD}			V	Over Ta and V _{DD}
Input low voltage (SDA, SCL)	V _{LOW}			0.3*V _{DD}	V	Over Ta and V _{DD}
SDA output low voltage	V _{OL}			0.4	V	Over Ta and V _{DD} I _{SINK} =3mA
SDA leakage	I _{SDA_leak}			± 10	µA	V _{SDA} =3.6V, Ta=85°C
SCL leakage	I _{SCL_leak}			± 10	µA	V _{SCL} =3.6V, Ta=85°C
SDA capacitance	C _{SDA}			10	pF	
SCL capacitance	C _{SCL}			10	pF	
Acknowledge setup time	T _{SUAC(MD)}			0.45	µs	
Acknowledge hold time	T _{DUAC(MD)}			0.45	µs	
Acknowledge setup time	T _{SUAC(SD)}			0.45	µs	
Acknowledge hold time	T _{DUAC(SD)}			0.45	µs	
I ² C clock frequency	F _{I2C}		0.4	1	MHz	
EEPROM erase/write cycles				10	times	
Write cell time	T _{WRITE}	5			ms	

Table 5 Electrical specification

NOTE 1: For best performance it is recommended to keep the supply voltage as accurate and stable as possible to 3.3V ± 0.05V

NOTE 2: When a data in EEPROM cell to be changed an erase (write 0x0000) must be done prior to writing the new value. After each write at least 5ms delay is needed in order to writing process to take place.

NOTE 3: Slave address 0x00 must be avoided.

NOTE 4: According to I²C standard the max sink current is specified to be 20mA, however due to the thermal considerations (the dissipated power into the driver) the max current is limited to 10mA. This is the only parameter which does not comply with the FM+ specification.

NOTE 5: Max EEPROM I²C speed operations to be done at 400kHz

9. False pixel correction

The imager can have up to 4 defective pixels, with either no output or out of specification temperature reading. These pixels are identified in the EEPROM table of the sensor and can be read out through the I²C. The defective pixel result can be replaced by an interpolation of its neighboring pixels.

10. Detailed General Description

10.1. Pixel position

The array consists of 768 IR sensors (also called pixels). Each pixel is identified with its row and column position as Pix(*i,j*) where *i* is its row number (from 1 to 24) and *j* is its column number (from 1 to 32)

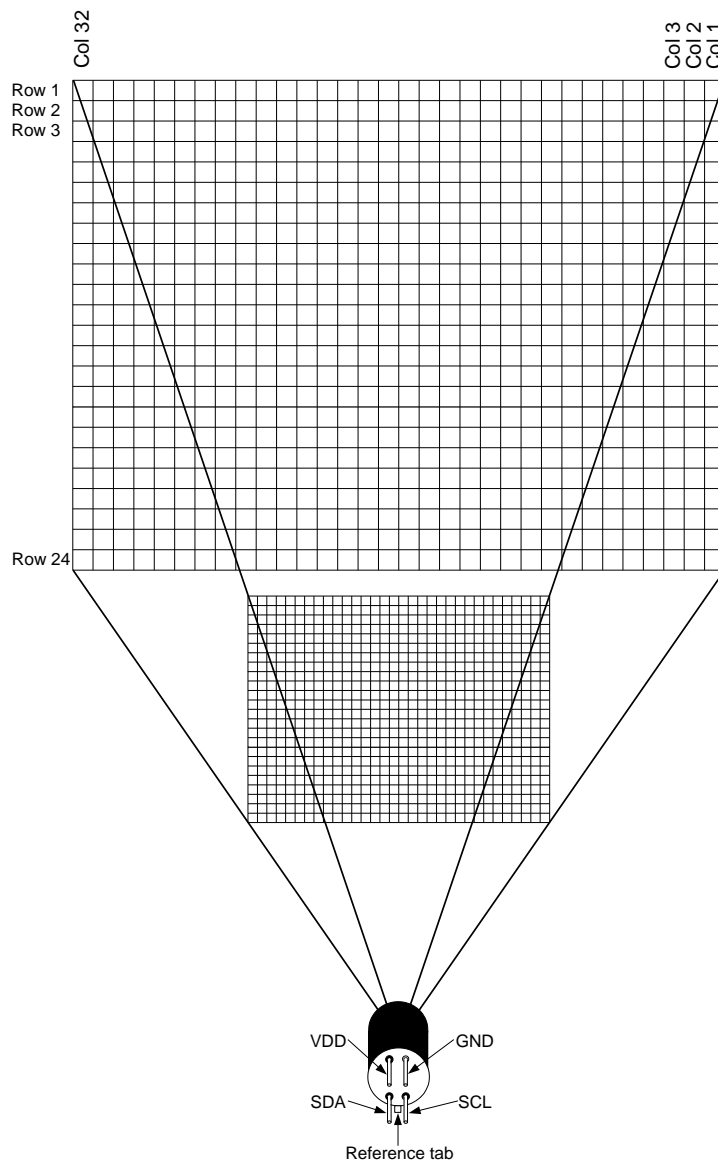

Figure 3 Pixel in the whole FOV

10.2. Communication protocol

The device use I²C protocol with support of FM+ mode (up to 1MHz clock frequency) and can be only slave on the bus. The SDA and SCL ports are 5V tolerant and the sensor can be directly connected to a 5V I²C network. The slave address is programmable and can have up to 127 different slave addresses.

10.2.1. Low level

10.2.1.1. Start / Stop conditions

Each communication session is initiated by a START condition and ends with a STOP condition. A START condition is initiated by a HIGH to LOW transition of the SDA while a STOP is generated by a LOW to HIGH transition. Both changes must be done while the SCL is HIGH.

10.2.1.2. Device addressing

The master is addressing the slave device by sending a 7-bit slave address after the START condition. The first seven bits are dedicated for the address and the 8th is Read/Write (R/W) bit. This bit indicates the direction of the transfer:

- Read (HIGH) means that the master will read the data from the slave
- Write (LOW) means that the master will send data to the slave

10.2.1.3. Acknowledge

During the 9th clock following every byte transfer the transmitter releases the SDA line. The receiver acknowledges (ACK) receiving the byte by pulling SDA line to low or does not acknowledge (NoACK) by letting the SDA 'HIGH'.

10.2.1.4. I²C command format



Figure 4 I²C write command format (default SA=0x33 is used)

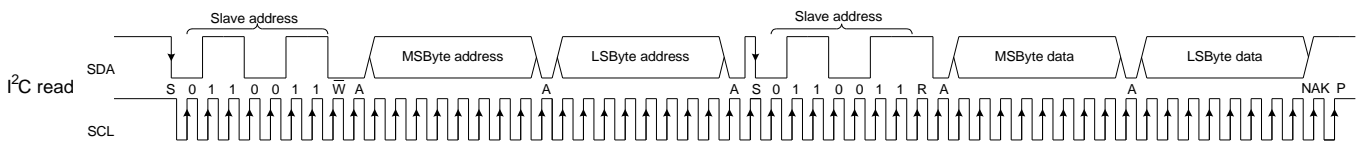

Figure 5 I²C read command format (default SA=0x33 is used)

10.3. Measurement mode

In this mode the measurements are constantly running. Depending on the selected frame rate F_{ps} in the control register, the data for IR pixels and T_a will be updated in the RAM each $\frac{1}{F_{ps}}$ second. In this mode the external microcontroller has full access to the internal registers and memories of the device.

10.4. Refresh rate

The refresh rate is configured by “Control register 1” (0x800D) i.e. if “Refresh rate control” = 011 → 4Hz this would mean that each 250ms a new subpage data is available in the RAM.

NOTE: It is possible to program the desired refresh rate into device EEPROM eliminating the necessity to reconfigure the device every time it is powered on. The corresponding EEPROM cell is at address 0x240C (see Table 8)

Which subpage is updated is indicated by the “Last measured subpage” field.

It is important to read both subpages as the necessary information for the T_a calculations is only available by combining the data from both subpages i.e. the T_a is refreshed with an update speed twice as low as the one set in “Refresh rate control”.

When a complete new data set (subpage) is available, a dedicated bit is set to indicate this – bit 3 “New data available in RAM” in “Status register” (0x8000). It is up to the customer to reset the bit once the data has been read.

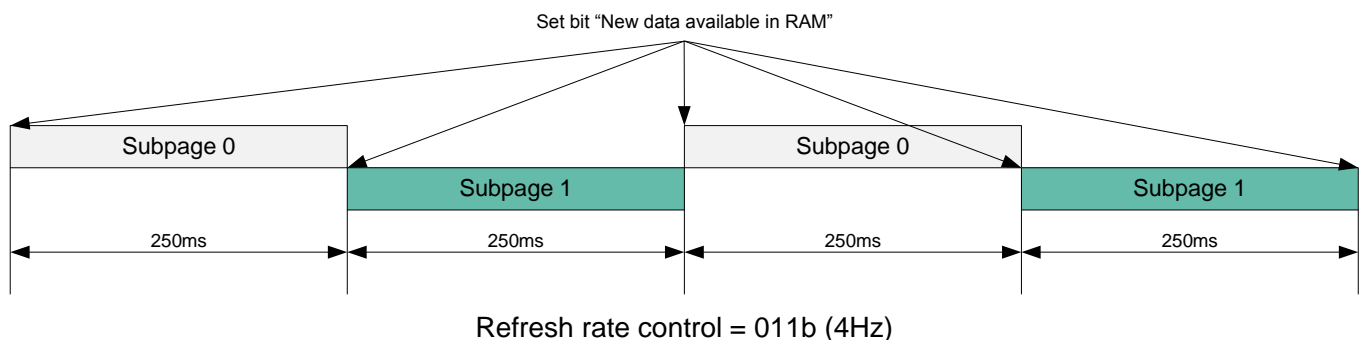

Figure 6 Refresh rate timing

10.5. Measurement flow

Following measurement flow is recommended:

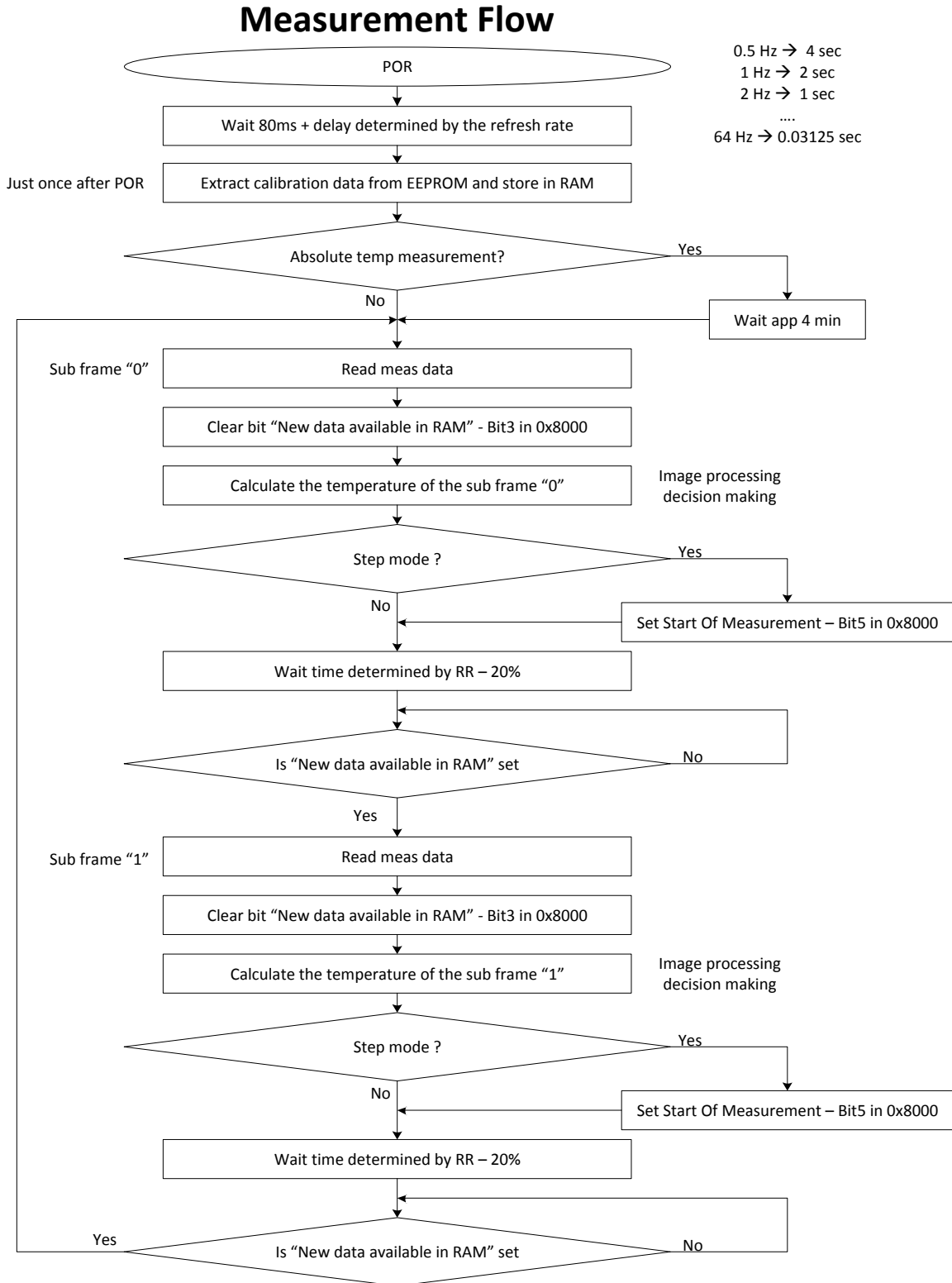

Figure 7 Recommended measurement flow

10.6. Reading patterns

The array frame is divided in two subpages and depending of bit 12 in “Control register 1” (0x800D) – “Reading pattern” there are two modes of the pixel arrangement:

- Chess pattern mode (factory default)
- TV interleave mode

NOTE1: As a standard the MLX90640 is calibrated in Chess pattern mode, this results in better fixed pattern noise behaviour of the sensor when in chess pattern mode. For best results Melexis advises to use chess pattern mode.

NOTE2: Please make sure a proper configuration of the subpage control bit is done. See: [Table 6 Priorities of subpage controls](#)

10.7. Address map

0x0000	ROM
0x03FF	
0x0400	RAM
0x07FF	
0x2400	EEPROM
0x273F	
0x8000	Registers (MLX reserved)
0x800C	
0x800D	Registers
0x8010	
0x8011	Registers (MLX reserved)
0x8016	

Figure 10 MXL90640 memory map

10.7.1. Internal registers

There are a few internal registers that are customer accessible through which the device performance can be customized:

B15	B14	B13	B12	B11	B10	B9	B8	B7	B6	B5	B4	B3	B2	B1	B0					
Melexis reserved											Enable overwrite	New data available in RAM	Last measured subpage controlled by MLX90641			Status register - 0x8000				
													0	0	0		Measurement of subpage 0 has been measured			
													0	0	1		Measurement of subpage 1 has been measured			
													0	1	0		Melexis reserved			
													0	1	1		Melexis reserved			
													1	0	0		Melexis reserved			
													1	0	1		Melexis reserved			
													1	1	0		Melexis reserved			
													1	1	1		Melexis reserved			
													0	No new data is available in RAM (must be reset by the customer)						
													1	A new data is available in RAM						
													0	Data in RAM overwrite is disabled						
													1	Data in RAM overwrite is enabled						
											Melexis reserved									

Figure 11 Status register (0x8000) bits meaning

B15	B14	B13	B12	B11	B10	B9	B8	B7	B6	B5	B4	B3	B2	B1	B0
Melexis reserved			Reading pattern	Resolution control		Refresh rate control			Select subpage			Enable subpages repeat	Enable data hold	Melexis reserved	Enable subpages mode
Control register 1 - 0x800D															
0 No subpages, only one page will be measured 1 Subpage mode is activated (default)															
0 Keep this bit = "0" (default)															
0 Transfer the data into storage RAM at each measured frame (default) 1 Transfer the data into storage RAM only if en_overwrite = 1 (check 0x8000)															
0 Toggles between subpage "0" and subpage "1" if Enable subpages mode = "1" (default) 1 Select subpage determines which subpage to be measured if Enable subpages mode = "1"															
0 0 0 Subpage 0 is selected (default) 0 0 1 Subpage 1 is selected 0 1 0 Not Applicable 0 1 1 Not Applicable 1 0 0 Not Applicable 1 0 1 Not Applicable 1 1 0 Not Applicable 1 1 1 Not Applicable															
0 0 0 IR refresh rate = 0.5Hz 0 0 1 IR refresh rate = 1Hz 0 1 0 IR refresh rate = 2Hz (default) 0 1 1 IR refresh rate = 4Hz 1 0 0 IR refresh rate = 8Hz 1 0 1 IR refresh rate = 16Hz 1 1 0 IR refresh rate = 32Hz 1 1 1 IR refresh rate = 64Hz															
0 0 ADC set to 16 bit resolution 0 1 ADC set to 17 bit resolution 1 0 ADC set to 18 bit resolution (default) 1 1 ADC set to 19 bit resolution															
0 Interleaved (TV) mode 1 Chess pattern (default)															
- - - Melexis reserved															

Figure 12 Control register1 (0x800D) bits meaning

Enable subpage mode (Bit 0)	Enable subpage repeat (Bit 3)	Select subpage (Bit 4)	Working mode
0	0	-	measure subpage 0 only
0	1	-	measure subpage 0 only
1	0	-	0 → 1 → 0 → 1 ...
1	1	0	measure subpage 0 only
1	1	1	measure subpage 1 only

Table 6 Priorities of subpage controls (0x800D)

B7	B6	B5	B4	B3	B2	B1	B0	B7	B6	B5	B4	B3	B2	B1	B0				
Melexis reserved												Melexis reserved	SDA driver current limit control	I2C threshold levels	FM+ disable	I2C configuration register - 0x800F 0 FM+ mode enabled (default) 1 FM+ mode disabled 0 VDD referred threshold (normal mode) (default) 1 1.8V referred threshold (1.8V mode) 0 SDA driver current limit is ON (default) 1 SDA driver current limit is OFF 0 Melexis reserved Melexis reserved			

Figure 13 I²C configuration register (0x800F) bits meaning

10.7.2. RAM

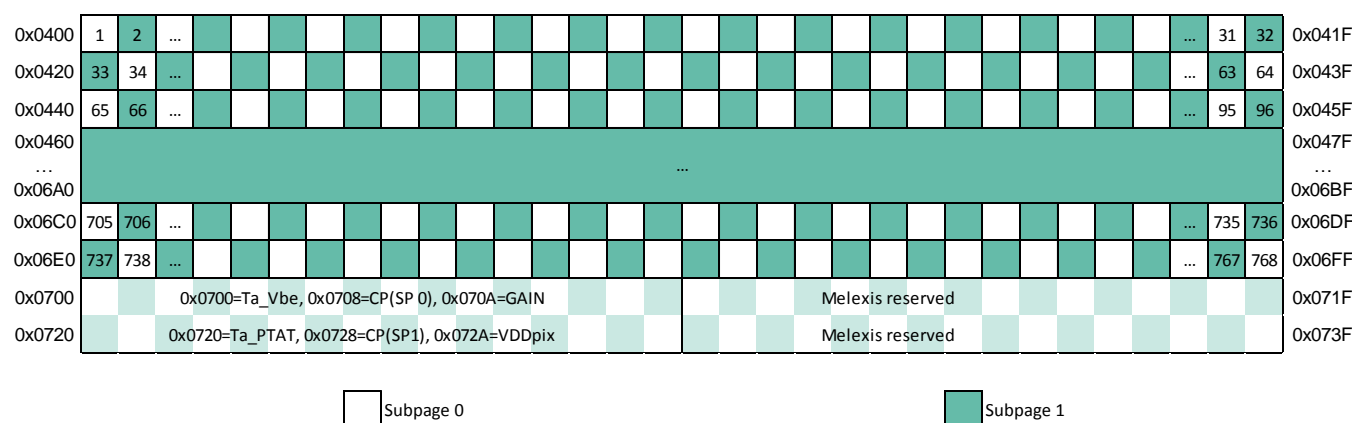

Figure 14 RAM memory map (Chess pattern mode) – factory default mode

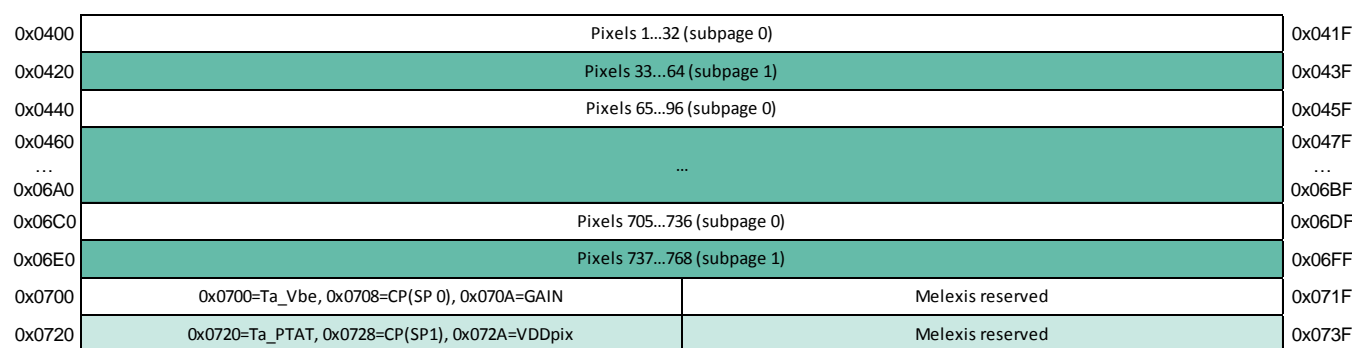

Figure 15 RAM memory map (Interleaved mode)

10.7.3. EEPROM

The EEPROM is used to store the calibration constants and the configuration parameters of the device

EEPROM address	Access	Meaning
0x2400	Melexis	Melexis reserved
0x2401	Melexis	Melexis reserved
0x2402	Melexis	Melexis reserved
0x2403	Melexis	Configuration register
0x2404	Melexis	Melexis reserved
0x2405	Melexis	Melexis reserved
0x2406	Melexis	Melexis reserved
0x2407	Melexis	Device ID1
0x2408	Melexis	Device ID2
0x2409	Melexis	Device ID3
0x240A	Melexis	Device Options
0x240B	Melexis	Melexis reserved
0x240C	Customer	Control register_1
0x240D	Customer	Control register_2
0x240E	Customer	I2CConfReg
0x240F	Customer	Melexis reserved / I2C_Address

Table 7 Configuration parameters memory

After POR the device read dedicated EEPROM cells and transfers their content to into the control and configuration register of the device. This way the device is configured and prepared for operation. The relation between EEPROM and register address is shown here after (explanation of the bit meaning can be found in section 10.7.1 Internal registers:

EEPROM address	Register address	Access	Name	Data [hex]
0x240C	0x800D	Customer	Control_register_1	1901
0x240D	0x800E	Customer	Control_register_2	0000
0x240E	0x800F	Customer	I2CConfReg	0000
0x240F	0x8010	Customer	Melexis internal use (8 bit) I2C_Address (8bit)	BE33

Table 8 EEPROM to registers mapping

Address	0	1	2	3	4	5	6	7	8	9	A	B	C	D	E	F	
0x2400	Osc Trim	Ana Trim	MLX	Conf reg	MLX	MLX	MLX	ID 1	ID 2	ID 3	MLX	MLX	Cont reg 1	Cont reg 2	I2C conf	I2C add	
0x2410	Scale OCC	Pix os avg	OCC_row_01...24 (6 x 4 x 3bit+sign)						OCC_column_01...32 (8 x 4 x 3bit+sign)								
0x2420	Scale ACC	Pix α avg	ACC_row_01...24 (6 x 4 x 3bit+sign)						ACC_column_01...32 (8 x 4 x 3bit+sign)								
0x2430	GAIN	PTAT_25	Kv, Kt ptat	Kv Vdd_25	Kv_avg	MLX	Kta_avg	Kv, Kta Sca	ACP 1,2	Off - CP1,2	Kv, Kta Cp	KsTa, TGC	KsTo 4, 3	KsTo 2, 1	CT 4, 3		
0x2440																	
0x2450																	
0x2460																	
0x2470																	
0x2480																	
0x2490																	
0x24A0																	
0x24B0																	
0x24C0																	
0x24D0																	
0x24E0																	
0x24F0																	
0x2500																	
0x2510																	
0x2520																	
0x2530																	
0x2540																	
0x2550																	
0x2560																	
0x2570																	
0x2580																	
0x2590																	
0x25A0																	
0x25B0																	
0x25C0																	
0x25D0																	
0x25E0																	
0x25F0																	
0x2600																	
0x2610																	
0x2620																	
0x2630																	
0x2640																	
0x2650																	
0x2660																	
0x2670																	
0x2680																	
0x2690																	
0x26A0																	
0x26B0																	
0x26C0																	
0x26D0																	
0x26E0																	
0x26F0																	
0x2700																	
0x2710																	
0x2720																	
0x2730																	

768 x Offset, α, Kta, Outlier

Table 9 EEPROM overview (words)

Address \ bit	15	14	13	12	11	10	9	8	7	6	5	4	3	2	1	0
0x2410	(Alpha PTAT - 8)*4				scale_Occ_row				scale_Occ_col				scale_Occ_rem			
0x2411	± Pix_os_average															
0x2412	± OCC row 4				± OCC row 3				± OCC row 2				± OCC row 1			
0x2413	± OCC row 8				± OCC row 7				± OCC row 6				± OCC row 5			
0x2414	± OCC row 12				± OCC row 11				± OCC row 10				± OCC row 9			
0x2415	± OCC row 16				± OCC row 15				± OCC row 14				± OCC row 13			
0x2416	± OCC row 20				± OCC row 19				± OCC row 18				± OCC row 17			
0x2417	± OCC row 24				± OCC row 23				± OCC row 22				± OCC row 21			
0x2418	± OCC column 4				± OCC column 3				± OCC column 2				± OCC column 1			
0x2419	± OCC column 8				± OCC column 7				± OCC column 6				± OCC column 5			
0x241A	± OCC column 12				± OCC column 11				± OCC column 10				± OCC column 9			
0x241B	± OCC column 16				± OCC column 15				± OCC column 14				± OCC column 13			
0x241C	± OCC column 20				± OCC column 19				± OCC column 18				± OCC column 17			
0x241D	± OCC column 24				± OCC column 23				± OCC column 22				± OCC column 21			
0x241E	± OCC column 28				± OCC column 27				± OCC column 26				± OCC column 25			
0x241F	± OCC column 32				± OCC column 31				± OCC column 30				± OCC column 29			
0x2420	Alpha scale - 30				Scale_ACC_row				Scale_ACC_column				Scale_ACC_remand			
0x2421	± Pix_sensitivity_average															
0x2422	± ACC row 4				± ACC row 3				± ACC row 2				± ACC row 1			
0x2423	± ACC row 8				± ACC row 7				± ACC row 6				± ACC row 5			
0x2424	± ACC row 12				± ACC row 11				± ACC row 10				± ACC row 9			
0x2425	± ACC row 16				± ACC row 15				± ACC row 14				± ACC row 13			
0x2426	± ACC row 20				± ACC row 19				± ACC row 18				± ACC row 17			
0x2427	± ACC row 24				± ACC row 23				± ACC row 22				± ACC row 21			
0x2428	± ACC column 4				± ACC column 3				± ACC column 2				± ACC column 1			
0x2429	± ACC column 8				± ACC column 7				± ACC column 6				± ACC column 5			
0x242A	± ACC column 12				± ACC column 11				± ACC column 10				± ACC column 9			
0x242B	± ACC column 16				± ACC column 15				± ACC column 14				± ACC column 13			
0x242C	± ACC column 20				± ACC column 19				± ACC column 18				± ACC column 17			
0x242D	± ACC column 24				± ACC column 23				± ACC column 22				± ACC column 21			
0x242E	± ACC column 28				± ACC column 27				± ACC column 26				± ACC column 25			
0x242F	± ACC column 32				± ACC column 31				± ACC column 30				± ACC column 29			
0x2430	± GAIN															
0x2431	± PTAT_25															
0x2432	± Kv_PTAT								± Kt_PTAT							
0x2433	± Kv_Vdd								± Vdd_25							
0x2434	± Kv_avg_RowOdd-ColumnOdd				± Kv_avg_RowEven-ColumnOdd				± Kv_avg_RowOdd-ColumnEven				± Kv_avg_RowEven-ColumnEven			
0x2435	± IL_CHESS_C3 - 5 bits				± IL_CHESS_C2 - 5 bits				± IL_CHESS_C1 - 6 bits							
0x2436	± Kta_avg_RowOdd-ColumnOdd				± Kta_avg_RowEven-ColumnOdd				± Kta_avg_RowOdd-ColumnEven				± Kta_avg_RowEven-ColumnEven			
0x2437	± Kta_avg_RowOdd-ColumnEven				± Kta_avg_RowEven-ColumnEven											
0x2438	MLX	Res control calib			Kv scale				Kta scale_1				Kta scale_2			
0x2439	± Alpha (CP subpage_1 / CP subpage_0 - 1)*2^7								Alpha CP subpage_0							
0x243A	± Offset (CP subpage_1 - CP subpage_0)								± Offset CP subpage_0							
0x243B	± Kv_CP								± Kta_CP							
0x243C	± KsTa*2^13								TGC (±4)*2^7							
0x243D	± KsTo range 2 (0°C...CT1°C)								± KsTo range 1 (<0°C)							
0x243E	± KsTo range 4 (CT2°C...)								± KsTo range 3 (CT1°C...CT2°C)							
0x243F	MLX	temp step x 10			CT4				CT3				KsTo Scale offset - 8			
0x2440	± Offset pixel (1, 1)								α pixel (1, 1)				± Kta (1, 1)			
0x2441	± Offset pixel (1, 2)								α pixel (1, 2)				± Kta (1, 2)			
...			
0x245E	± Offset pixel (1, 31)								α pixel (1, 31)				± Kta (1, 31)			
0x245F	± Offset pixel (1, 32)								α pixel (1, 32)				± Kta (1, 32)			
0x2460	± Offset pixel (2, 1)								α pixel (2, 1)				± Kta (2, 1)			
0x2461	± Offset pixel (2, 2)								α pixel (2, 2)				± Kta (2, 2)			
...			
0x273E	± Offset pixel (24, 31)								α pixel (24, 31)				± Kta (24, 31)			
0x273F	± Offset pixel (24, 32)								α pixel (24, 32)				± Kta (24, 32)			

Table 10 Calibration parameters memory (EEPROM - bits)

NOTE 1: EEPROM addresses from 0x2440...0x273F contain the individual pixel calibration information and may not be equal to 0x0000. In case any pixel data is equal to 0x0000 this means that this particular pixels has failed and the calculation for To should not be trusted and avoided. Depending on the application, the To value for such pixels can be replaced with a default value such as -273.15°C, can be equal to Ta or one calculate an average value from the adjacent pixels.

NOTE 2: The LSB for EEPROM addresses from 0x2440...0x273F indicate if all pixel parameters are within the calibration specification. If this bit is set i.e. = "1" this would mean that at least one of the calibration parameters for this particular pixel is outside the calibration specifications and the pixel is considered as Outlier i.e. the sensor accuracy is not guaranteed by the calibration.

NOTE 3: Pixels identified during calibration process as potentially long term deviating pixels are marked in the same manner. Long term deviating pixels are identified in zone 1 and zone 2 only, zone 3 is excluded (for zone information please refer to paragraph 12.1.1 Figure 18). An unidentified long term deviating pixel may be still present.

NOTE 4: The maximum number of deviating pixels is 4 (please check False pixel correction), none of the deviating pixels are adjacent to each other. Depending on the application one may have to choose to replace the measurement results of such pixel by an average of the temperature indicated by the adjacent pixels.

11. Calculating Object Temperature

11.1. Restoring calibration data from EERPOM

NOTE: All data in the EEPROM is coded as two's complement (unless otherwise noted)

In the example we are restoring the calibration data for pixel (12, 16)

11.1.1. Restoring the VDD sensor parameters

Following formula is used to calculate the VDD of the sensor:

$$K_{Vdd} = \frac{EE[0x2433] \& 0xFF00}{2^8}$$

$$\text{If } K_{Vdd} > 127 \rightarrow K_{Vdd} = K_{Vdd} - 256$$

$$K_{Vdd} = K_{Vdd} * 2^5$$

$$VDD_{25} = EE[0x2433] \& 0x00FF$$

$$VDD_{25} = (VDD_{25} - 256) * 2^5 - 2^{13}$$

11.1.2. Restoring the Ta sensor parameters

Following formula is used to calculate the Ta of the sensor:

$$T_a = \frac{\left(\frac{V_{PTAT_{art}} - V_{PTAT_{25}}}{1 + K_{V_{PTAT}} \cdot \Delta V} \right)}{K_{T_{PTAT}}} + 25, \text{ } ^\circ\text{C}$$

Where:

$$K_{V_{PTAT}} = \frac{EE[0x2432] \& 0xFC00}{2^{10}}$$

$$\text{If } K_{V_{PTAT}} > 31 \rightarrow K_{V_{PTAT}} = K_{V_{PTAT}} - 64$$

$$K_{V_{PTAT}} = \frac{K_{V_{PTAT}}}{2^{12}}$$

$$K_{T_{PTAT}} = EE[0x2432] \& 0x03FF$$

$$\text{If } K_{T_{PTAT}} > 511 \rightarrow K_{T_{PTAT}} = K_{T_{PTAT}} - 1024$$

$$K_{T_{PTAT}} = \frac{K_{T_{PTAT}}}{2^3}$$

$$\Delta V = \frac{RAM[0x072A] - VDD_{25}}{K_V}$$

$$V_{PTAT_{25}} = EE[0x2431]$$

$$\text{If } V_{PTAT_{25}} > 32767 \rightarrow V_{PTAT_{25}} = V_{PTAT_{25}} - 65536$$

$$V_{PTAT_{art}} = \left(\frac{V_{PTAT}}{V_{PTAT} * \text{Alpha}_{PTAT} + V_{BE}} \right) * 2^{18}$$

Where:

$$V_{PTAT} = \text{RAM}[0x0720]$$

$$\text{If } V_{PTAT} > 32767 \rightarrow V_{PTAT} = V_{PTAT} - 65536$$

$$V_{BE} = \text{RAM}[0x0700]$$

$$\text{If } V_{BE} > 32767 \rightarrow V_{BE} = V_{BE} - 65536$$

$$\text{Alpha}_{PTAT_EE} = \frac{EE[0x2410] \& 0xF000}{2^{12}}$$

$$\text{Alpha}_{PTAT} = \frac{\text{Alpha}_{PTAT_EE}}{2^2} + 8$$

11.1.3. Restoring the offset

$$\text{pix}_{OS_{ref}}(i,j) = \text{Offset}_{average} + OCC_{row_i} * 2^{OCC_{scale_{row}}} + OCC_{column_j} * 2^{OCC_{scale_{column}}} + \text{offset}(i,j) * 2^{OCC_{scale_{remnant}}}$$

$$\text{Offset}_{average} = EE[0x2411]$$

$$\text{If } \text{Offset}_{average} > 32767 \rightarrow \text{Offset}_{average} = \text{Offset}_{average} - 65536$$

$$OCC_{row_{12}} = \frac{EE[0x2414] \& 0xF000}{2^{12}} \text{ (i.e. the four most significant bits, signed)}$$

$$\text{If } OCC_{row_{12}} > 7 \rightarrow OCC_{row_{12}} = OCC_{row_{12}} - 16$$

$$OCC_{scale_{row}} = \frac{EE[0x2410] \& 0x0F00}{2^8} \text{ (unsigned)}$$

$$OCC_{column_{16}} = \frac{EE[0x241B] \& 0xF000}{2^{12}} \text{ (i.e. the four most significant bits, signed)}$$

$$\text{If } OCC_{column_{16}} > 7 \rightarrow OCC_{column_{16}} = OCC_{column_{16}} - 16$$

$$OCC_{scale_{column}} = \frac{EE[0x2410] \& 0x00F0}{2^4} \text{ (unsigned)}$$

$$\text{offset}(12,16) = \frac{EE[0x25AF] \& 0xFC00}{2^{10}} \text{ (i.e. the six most significant bits, signed)}$$

$$\text{If } \text{offset}(12,16) > 31 \rightarrow \text{offset}(12,16) = \text{offset}(12,16) - 64$$

$$OCC_{scale_{remnant}} = EE[0x2410] \& 0x000F \text{ (unsigned)}$$

11.1.3.1. Restoring the offset in case of Interleaved reading pattern

To compensate the IR data for interleaved reading pattern following formula is used:

$$\text{pix}_{OS}(i,j) = \text{pix}_{gain}(i,j) + I_{CHESS_{c3}} * (2 * I_{PATTERN} - 1) - I_{CHESS_{c2}} * \text{Conversion}_{pattern} - \text{pix}_{OS_{ref}} * \left(1 + K_{Ta(i,j)} * (T_a - T_{a0}) \right) * \left(1 + K_{V(i,j)} * (V_{dd} - V_{dd0}) \right)$$

Highlighted in yellow parameters are extracted hereafter.

As a default the device is factory calibrated in Chess pattern mode thus the best performance will be when a Chess pattern is used. However some customers may choose to use the device in interleaved mode which will degrade the device performance. In this case a correction can be applied to restore to some extent the performance. Once the IR data is compensated the calculation for To is done using default flow. The goal of this correction is to equalize the offset of the pixels due to the different pattern reading modes. We can achieve this by using several correction coefficients stored into the device EEPROM extracted and decoded as follows:

$$IL_{CHESS_{C1EE}} = EE[0x2435] \& 0x003F$$

$$\text{If } IL_{CHESS_{C1EE}} > 31 \rightarrow IL_{CHESS_{C1EE}} = IL_{CHESS_{C1EE}} - 64$$

$$IL_{CHESS_{C1}} = \frac{IL_{CHESS_{C1EE}}}{2^4}$$

$$IL_{CHESS_{C2EE}} = \frac{EE[0x2435] \& 0x07C0}{2^6}$$

$$\text{If } IL_{CHESS_{C2EE}} > 15 \rightarrow IL_{CHESS_{C2EE}} = IL_{CHESS_{C2EE}} - 32$$

$$L_{CHESS_{C2}} = \frac{IL_{CHESS_{C2EE}}}{2}$$

$$IL_{CHESS_{C3EE}} = \frac{EE[0x2435] \& 0xF800}{2^{11}}$$

$$\text{If } IL_{CHESS_{C3EE}} > 15 \rightarrow IL_{CHESS_{C3EE}} = IL_{CHESS_{C3EE}} - 32$$

$$IL_{CHESS_{C3}} = \frac{IL_{CHESS_{C3EE}}}{2^3}$$

The above calculated parameters have to be applied as a correction for the offset of each individual pixel. We do need additional patterns in order to make these calculations and the formula to calculate those patterns are as shown below depending on the pixels number:

$$IL_{PATTERN} = \text{int} \left(\frac{\text{pixel}_{number}-1}{32} \right) - \text{int} \left(\frac{\text{int} \left(\frac{\text{pixel}_{number}-1}{32} \right)}{2} \right) * 2$$

$$\text{Conversion}_{pattern} = \left(\text{int} \left(\frac{\text{pixel}_{number}-3}{4} \right) - \text{int} \left(\frac{\text{pixel}_{number}-2}{4} \right) + \text{int} \left(\frac{\text{pixel}_{number}}{4} \right) - \text{int} \left(\frac{\text{pixel}_{number}-1}{4} \right) \right) * (1 - 2 * IL_{PATTERN})$$

11.1.4. Restoring the Sensitivity $\alpha_{(i,j)}$

$$\alpha_{(i,j)} = \frac{\alpha_{reference} + ACC_{row_i} * 2^{ACC_{scale_{row}}} + ACC_{column_j} * 2^{ACC_{scale_{column}}} + \alpha_{pixel(i,j)} * 2^{ACC_{scale_{remnant}}}}{2^{\alpha_{scale}}}$$

Where (calculating for pixel (12,16)) :

$$\alpha_{reference} = EE[0x2421]$$

$$\alpha_{scale} = \frac{EE[0x2420] \& 0xF000}{2^{12}} + 30$$

$$ACC_{row_{12}} = \frac{EE[0x2424] \& 0xF000}{2^{12}} \text{ (i.e. the four most significant bits, signed)}$$

$$\text{If } ACC_{row_{12}} > 7 \rightarrow ACC_{row_{12}} = ACC_{row_{12}} - 16$$

$$ACC_{scale_{row}} = \frac{EE[0x2420] \& 0x0F00}{2^8} \text{ (unsigned)}$$

$$ACC_{column_{16}} = \frac{EE[0x242B] \& 0xF000}{2^{12}} \text{ (i.e. the four most significant bits, signed)}$$

$$\text{If } ACC_{column_{16}} > 7 \rightarrow ACC_{column_{16}} = ACC_{column_{16}} - 16$$

$$ACC_{scale_{column}} = \frac{EE[0x2420] \& 0x00F0}{2^4} \text{ (unsigned)}$$

$$\alpha_{pixel}(12,16) = \frac{EE[0x258F] \& 0x03F0}{2^4}$$

$$\text{If } \alpha_{pixel}(12,16) > 31 \rightarrow \alpha_{pixel}(12,16) = \alpha_{pixel}(12,16) - 64$$

$$ACC_{scale_{remnant}} = EE[0x2420] \& 0x000F \text{ (unsigned)}$$

11.1.5. Restoring the $K_V(i,j)$ coefficient

$K_{V(i,j)}$ depend on the pixel position in the array i.e. if the pixel row and column is odd or even

$$\text{If row number is **ODD** (1, 3, 5...23) and column number is **ODD** (1, 3, 5...31) then } K_{V(i,j)} = \frac{EE[0x2434] \& 0xF000}{2^{12}}$$

$$\text{If row number is **EVEN** (2, 4, 6...24) and column number is **ODD** (1, 3, 5...31) then } K_{V(i,j)} = \frac{EE[0x2434] \& 0x0F00}{2^8}$$

$$\text{If row number is **ODD** (1, 3, 5...23) and column number is **EVEN** (2, 4, 6...32) then } K_{V(i,j)} = \frac{EE[0x2434] \& 0x00F0}{2^4}$$

$$\text{If row number is **EVEN** (2, 4, 6...24) and column number is **EVEN** (2, 4, 6...32) then } K_{V(i,j)} = EE[0x2434] \& 0x000F$$

$$\text{If } K_{V(i,j)} > 7 \rightarrow K_{V(i,j)} = K_{V(i,j)} - 16$$

$$K_{V(12,16)} = \frac{K_{V(i,j)}}{2^{K_{V_{scale}}}} \text{ (signed)}$$

Where:

$$K_{V_{scale}} = \frac{EE[0x2438] \& 0x0F00}{2^8} \text{ (unsigned)}$$

11.1.6. Restoring the $K_{Ta}(i,j)$ coefficient

$$K_{Ta(12,16)} = \frac{K_{Ta_{RC_EE}} + K_{Ta(12,16)_EE} * 2^{K_{Ta_{scale_2}}}}{2^{K_{Ta_{scale_1}}}}$$

Where:

$$K_{Ta(12,16)_EE} = \frac{EE[0x25AF] \& 0x000E}{2} \text{ (signed)}$$

$$\text{If } K_{Ta(12,16)_EE} > 3 \rightarrow K_{Ta(12,16)_EE} = K_{Ta(12,16)_EE} - 8$$

$K_{Ta_RC_EE}$ depends on the pixel position in the array i.e. if the pixel row and column is odd or even

If row number is **ODD** (1, 3, 5...23) and column number is **ODD** (1, 3, 5...31) then $K_{Ta_RC_EE} = \frac{EE[0x2436] \& 0xFF00}{2^8}$

If row number is **EVEN** (2, 4, 6...24) and column number is **ODD** (1, 3, 5...31) then $K_{Ta_RC_EE} = EE[0x2436] \& 0x00FF$

If row number is **ODD** (1, 3, 5...23) and column number is **EVEN** (2, 4, 6...32) then $K_{Ta_RC_EE} = \frac{EE[0x2437] \& 0xFF00}{2^8}$

If row number is **EVEN** (2, 4, 6...24) and column number is **EVEN** (2, 4, 6...32) then $K_{Ta_RC_EE} = EE[0x2437] \& 0x00FF$

If $K_{Ta_RC_EE} > 127 \rightarrow K_{Ta_RC_EE} = K_{Ta_RC_EE} - 256$

$K_{Ta_scale_1} = \frac{EE[0x2438] \& 0x00F0}{2^4} + 8$ (unsigned)

$K_{Ta_scale_2} = EE[0x2438] \& 0x000F$ (unsigned)

11.1.7. Restoring the GAIN coefficient (common for all pixels)

GAIN = $EE[0x2430]$ (signed)

If GAIN > 32767 \rightarrow GAIN = GAIN – 65536

11.1.8. Restoring the KsTa coefficient (common for all pixels)

$K_{STa} = \frac{K_{STa_EE}}{2^{13}}$

Where:

$K_{STa_EE} = \frac{EE[0x243C] \& 0xFF00}{2^8}$ (signed)

If $K_{STa_EE} > 127 \rightarrow K_{STa_EE} = K_{STa_EE} - 256$

11.1.9. Restoring corner temperatures (common for all pixel)

The information regarding corner temperatures is stored into device EEPROM and is restored as follows:

$Step = \frac{EE[0x243F] \& 0x3000}{2^{12}} * 10$

$CT3 = \frac{EE[0x243F] \& 0x00F0}{2^4} * Step$

$CT4 = \frac{EE[0x243F] \& 0x0F00}{2^8} * Step + CT3$

Or we can construct the temperatures for the ranges as follows:

CT1=-40°C (hard coded) < **Range 1** > CT2=0°C (hard coded) < **Range 2** > CT3 < **Range 3** > CT4 < **Range 4**

11.1.10. Restoring the KsTo coefficient (common for all pixels)

$$K_{STo1} = \frac{K_{STo1_EE}}{2^{K_{STo_scale}}}$$

Where:

$$K_{STo_scale} = EE[0x243F] \& 0x000F + 8 \text{ (unsigned)}$$

Where:

$$K_{STo1_EE} = EE[0x243D] \& 0x00FF \text{ (signed)}$$

$$\text{If } K_{STo1_EE} > 127 \rightarrow K_{STo1_EE} = K_{STo1_EE} - 256$$

$$K_{STo2} = \frac{K_{STo2_EE}}{2^{K_{STo_scale}}}$$

Where:

$$K_{STo2_EE} = \frac{EE[0x243D] \& 0xFF00}{2^8} \text{ (signed)}$$

$$\text{If } K_{STo2_EE} > 127 \rightarrow K_{STo2_EE} = K_{STo2_EE} - 256$$

$$K_{STo3} = \frac{K_{STo3_EE}}{2^{K_{STo_scale}}}$$

Where:

$$K_{STo3_EE} = EE[0x243E] \& 0x00FF \text{ (signed)}$$

$$\text{If } K_{STo3_EE} > 127 \rightarrow K_{STo3_EE} = K_{STo3_EE} - 256$$

$$K_{STo4} = \frac{K_{STo4_EE}}{2^{K_{STo_scale}}}$$

Where:

$$K_{STo4_EE} = \frac{EE[0x243E] \& 0x00FF}{2^8} \text{ (signed)}$$

$$\text{If } K_{STo4_EE} > 127 \rightarrow K_{STo4_EE} = K_{STo4_EE} - 256$$

11.1.11. Restoring sensitivity correction coefficients for each temperature range

$$Alpha_{corr_{range1}} = \frac{1}{(1 + K_{STo1} * (0 - (-40)))}$$

$$Alpha_{corr_{range2}} = 1$$

$$Alpha_{corr_{range3}} = 1 + K_{STo2} * (CT3 - 0)$$

$$Alpha_{corr_{range4}} = (1 + K_{STo2} * (CT3 - 0)) * (1 + K_{STo3} * (CT4 - CT3))$$

11.1.12. Restoring the Sensitivity α_{CP}

Please note that there are two sensitivities for the compensation pixel – one for each subpage

$$\alpha_{CP_subpage_0} = \frac{EE[0x2439] \& 0x03FF}{2^{\alpha_{scale_CP}}}$$

$$\alpha_{CP_subpage_1} = \alpha_{CP_subpage_0} * \left(1 + \frac{CP_P1_P0_ratio}{2^7}\right)$$

Where:

$$\alpha_{scale_CP} = \frac{EE[0x2420] \& 0xF000}{2^{12}} + 27$$

$$CP_P1/P0_ratio = \frac{EE[0x2439] \& 0xFC00}{2^{10}} \text{ (signed)}$$

$$\text{If } CP_P1/P0_ratio > 31 \rightarrow CP_P1/P0_ratio = CP_P1/P0_ratio - 64$$

11.1.13. Restoring the offset of the Compensation Pixel (CP)

Please note that there are two offsets for the compensation pixel – one for each subpage

$$Off_CP_subpage_0 = EE[0x243A] \& 0x03FF \text{ (signed)}$$

$$\text{If } Off_CP_subpage_0 > 511 \rightarrow Off_CP_subpage_0 = Off_CP_subpage_0 - 1024$$

$$Off_CP_subpage_1 = Off_CP_subpage_0 + Off_CP_subpage_1_delta$$

Where:

$$Off_CP_subpage_1_delta = \frac{EE[0x243A] \& 0xFC00}{2^{10}} \text{ (signed)}$$

$$\text{If } Off_CP_subpage_1_delta > 31 \rightarrow Off_CP_subpage_1_delta = Off_CP_subpage_1_delta - 64$$

11.1.14. Restoring the Kv CP coefficient

$$K_{VCP} = \frac{K_{VCP_EE}}{2^{K_{Vscale}}}$$

$$K_{Vscale} = \frac{EE[0x2438] \& 0x0F00}{2^8} \text{ (unsigned) (the same one as for the } K_{V(i,j)} \text{ coefficients)}$$

Where:

$$K_{VCP_EE} = \frac{EE[0x243B] \& 0xFF00}{2^8} \text{ (signed)}$$

$$\text{If } K_{VCP_EE} > 127 \rightarrow K_{VCP_EE} = K_{VCP_EE} - 256$$

11.1.15. Restoring the Kta CP coefficient

$$K_{TaCP} = \frac{K_{TaCP_EE}}{2^{K_{Ta_scale_1}}}$$

$$K_{Ta_{scale_1}} = \frac{EE[0x2438] \& 0x00F0}{2^4} + 8 \text{ (unsigned) (the same one as for the } K_{Ta(i,j)} \text{ coefficients)}$$

Where:

$$K_{Ta_{CP_EE}} = EE[0x243B] \& 0x00FF \text{ (signed)}$$

$$\text{If } K_{Ta_{CP_EE}} > 127 \rightarrow K_{Ta_{CP_EE}} = K_{Ta_{CP_EE}} - 256$$

11.1.16. Restoring the TGC coefficient

$$TGC = \frac{TGC_{EE}}{2^5}$$

Where:

$$TGC_{EE} = EE[0x243C] \& 0x00FF \text{ (signed)}$$

$$\text{If } TGC_{EE} > 127 \rightarrow TGC_{EE} = TGC_{EE} - 256$$

NOTE 1: In a MLX90640ESF-BAx-000-TU device, the TGC coefficient is set to 0 and must not be changed.

NOTE 2: In a MLX90640ESF-BCx-000-TU device, the EEPROM contains a typical value for the TGC coefficient but the user may choose to adjust the value such to best fit for a specific application. Using the TGC increases noise in the temperature calculations which can be reduced by external filtering (averaging) of the CP sensor data. By making the TGC coefficient "0" the gradients compensation is bypassed.

11.1.17. Restoring the resolution control coefficient

$$Resolution_{EE} = \frac{EE[0x2438] \& 0x3000}{2^{12}} \text{ (unsigned)}$$

11.2. Temperature Calculation

11.2.1. Example Input Data

11.2.1.1. Example Measurement Data

Input data name	Input data value
Object temperature	80°C
Emissivity (ϵ)	1
Control register 1 (Res _{ctrl})	0x0901 (2 decimal)
RAM[0x056F] (pix(12,16) data)	0x0261 (609)
Vbe - RAM[0x0700]	0x4BF2 (19442)
CP subpage 0 – RAM[0x0708]	0xFFCA (-54)
CP subpage 1 – RAM[0x0728]	0xFFC8 (-56)
GAIN - RAM[0x070A]	0x1881 (6273)
PTAT - RAM[0x0720]	0x06AF (1711)
VDD - RAM[0x072A]	0xCCC5 (-13115)

Table 11 Calculation example input data

11.2.1.2. Example Calibration Data

EEPROM address	Calibration parameter name	Parameter value	Decoded value
0x2410	K_PTAT – 4 bits Scale_OCC_row – 4 bits Scale_OCC_column – 4 bits Scale_OCC_remnant – 4 bits	0x4210	K_PTAT = 9 Scale_OCC_row = 2 Scale_OCC_column = 1 Scale_OCC_remnant = 0
0x2411	Pix_os_average – 16 bits	0xFFBB	Pix_os_average = -69
0x2412	OCC_rows_04 – 4 bits OCC_rows_03 – 4 bits OCC_rows_02 – 4 bits OCC_rows_01 – 4 bits	0x0202	OCC_rows_04 = 0 OCC_rows_03 = 2 OCC_rows_02 = 0 OCC_rows_01 = 2
0x2413	OCC_rows_08 – 4 bits OCC_rows_07 – 4 bits OCC_rows_06 – 4 bits OCC_rows_05 – 4 bits	0xF202	OCC_rows_08 = -1 OCC_rows_07 = 2 OCC_rows_06 = 0 OCC_rows_05 = 2
0x2414	OCC_rows_12 – 4 bits OCC_rows_11 – 4 bits	0xF2F2	OCC_rows_12 = -1 OCC_rows_11 = 2

	OCC_rows_10 – 4 bits OCC_rows_09 – 4 bits		OCC_rows_10 = -1 OCC_rows_09 = 2
0x2415	OCC_rows_16 – 4 bits OCC_rows_15 – 4 bits OCC_rows_14 – 4 bits OCC_rows_13 – 4 bits	0xE2E2	OCC_rows_16 = -2 OCC_rows_15 = 2 OCC_rows_14 = -2 OCC_rows_13 = 2
0x2416	OCC_rows_20 – 4 bits OCC_rows_19 – 4 bits OCC_rows_18 – 4 bits OCC_rows_17 – 4 bits	0xD1E1	OCC_rows_20 = -3 OCC_rows_19 = 1 OCC_rows_18 = -2 OCC_rows_17 = 1
0x2417	OCC_rows_24 – 4 bits OCC_rows_23 – 4 bits OCC_rows_22 – 4 bits OCC_rows_21 – 4 bits	0xB1D1	OCC_rows_24 = -5 OCC_rows_23 = 1 OCC_rows_22 = -3 OCC_rows_21 = 1
0x2418	OCC_column_04 – 4 bits OCC_column_03 – 4 bits OCC_column_02 – 4 bits OCC_column_01 – 4 bits	0xF10F	OCC_column_04 = -1 OCC_column_03 = 1 OCC_column_02 = 0 OCC_column_01 = -1
0x2419	OCC_column_08 – 4 bits OCC_column_07 – 4 bits OCC_column_06 – 4 bits OCC_column_05 – 4 bits	0xF00F	OCC_column_08 = -1 OCC_column_07 = 0 OCC_column_06 = 0 OCC_column_05 = -1
0x241A	OCC_column_12 – 4 bits OCC_column_11 – 4 bits OCC_column_10 – 4 bits OCC_column_09 – 4 bits	0xE0EF	OCC_column_12 = -2 OCC_column_11 = 0 OCC_column_10 = -2 OCC_column_09 = -1
0x241B	OCC_column_16 – 4 bits OCC_column_15 – 4 bits OCC_column_14 – 4 bits OCC_column_13 – 4 bits	0xE0EF	OCC_column_16 = -2 OCC_column_15 = 0 OCC_column_14 = -2 OCC_column_13 = -1
0x241C	OCC_column_20 – 4 bits OCC_column_19 – 4 bits OCC_column_18 – 4 bits OCC_column_17 – 4 bits	0xE1E1	OCC_column_20 = -2 OCC_column_19 = 1 OCC_column_18 = -2 OCC_column_17 = 1
0x241D	OCC_column_24 – 4 bits OCC_column_23 – 4 bits OCC_column_22 – 4 bits OCC_column_21 – 4 bits	0xF3F2	OCC_column_24 = -1 OCC_column_23 = 3 OCC_column_22 = -1 OCC_column_21 = 2
0x241E	OCC_column_28 – 4 bits OCC_column_27 – 4 bits OCC_column_26 – 4 bits OCC_column_25 – 4 bits	0xF404	OCC_column_28 = -1 OCC_column_27 = 4 OCC_column_26 = 0 OCC_column_25 = 4
0x241F	OCC_column_32 – 4 bits OCC_column_31 – 4 bits	0xE504	OCC_column_32 = -2 OCC_column_31 = 5

	OCC_column_30 – 4 bits OCC_column_29 – 4 bits		OCC_column_30 = 0 OCC_column_29 = 4
0x2420	Alpha scale – 4 bits Scale_ACC_row – 4 bits Scale_ACC_column – 4 bits Scale_ACC_remand – 4 bits	0x79A6	Alpha scale = 37 Scale_ACC_row = 9 Scale_ACC_column = 10 Scale_ACC_remand = 6
0x2421	Pix_sensitivity_average - 16 bits	0x2F44	Pix_sensitivity_average = 8.80391E-08
0x2422	ACC_rows_04 – 4 bits ACC_rows_03 – 4 bits ACC_rows_02 – 4 bits ACC_rows_01 – 4 bits	0xFFDD	ACC_rows_04 = -1 ACC_rows_03 = -1 ACC_rows_02 = -3 ACC_rows_01 = -3
0x2423	ACC_rows_08 – 4 bits ACC_rows_07 – 4 bits ACC_rows_06 – 4 bits ACC_rows_05 – 4 bits	0x2210	ACC_rows_08 = 2 ACC_rows_07 = 2 ACC_rows_06 = 1 ACC_rows_05 = 0
0x2424	ACC_rows_12 – 4 bits ACC_rows_11 – 4 bits ACC_rows_10 – 4 bits ACC_rows_09 – 4 bits	0x3333	ACC_rows_12 = 3 ACC_rows_11 = 3 ACC_rows_10 = 3 ACC_rows_09 = 3
0x2425	ACC_rows_16 – 4 bits ACC_rows_15 – 4 bits ACC_rows_14 – 4 bits ACC_rows_13 – 4 bits	0x2233	ACC_rows_16 = 2 ACC_rows_15 = 2 ACC_rows_14 = 3 ACC_rows_13 = 3
0x2426	ACC_rows_20 – 4 bits ACC_rows_19 – 4 bits ACC_rows_18 – 4 bits ACC_rows_17 – 4 bits	0xEF01	ACC_rows_20 = -2 ACC_rows_19 = -1 ACC_rows_18 = 0 ACC_rows_17 = 1
0x2427	ACC_rows_24 – 4 bits ACC_rows_23 – 4 bits ACC_rows_22 – 4 bits ACC_rows_21 – 4 bits	0x9ACC	ACC_rows_24 = -7 ACC_rows_23 = -6 ACC_rows_22 = -4 ACC_rows_21 = -4
0x2428	ACC_column_04 – 4 bits ACC_column_03 – 4 bits ACC_column_02 – 4 bits ACC_column_01 – 4 bits	0xEEDC	ACC_column_04 = -1 ACC_column_03 = -1 ACC_column_02 = -2 ACC_column_01 = -3
0x2429	ACC_column_08 – 4 bits ACC_column_07 – 4 bits ACC_column_06 – 4 bits ACC_column_05 – 4 bits	0x10FF	ACC_column_08 = 1 ACC_column_07 = 0 ACC_column_06 = -1 ACC_column_05 = -1
0x242A	ACC_column_12 – 4 bits ACC_column_11 – 4 bits ACC_column_10 – 4 bits ACC_column_09 – 4 bits	0x2221	ACC_column_12 = 2 ACC_column_11 = 2 ACC_column_10 = 2 ACC_column_09 = 1

0x242B	ACC_column_16 – 4 bits ACC_column_15 – 4 bits ACC_column_14 – 4 bits ACC_column_13 – 4 bits	0x3333	ACC_column_16 = 3 ACC_column_15 = 3 ACC_column_14 = 3 ACC_column_13 = 3
0x242C	ACC_column_20 – 4 bits ACC_column_19 – 4 bits ACC_column_18 – 4 bits ACC_column_17 – 4 bits	0x2333	ACC_column_20 = 2 ACC_column_19 = 3 ACC_column_18 = 3 ACC_column_17 = 3
0x242D	ACC_column_24 – 4 bits ACC_column_23 – 4 bits ACC_column_22 – 4 bits ACC_column_21 – 4 bits	0x0112	ACC_column_24 = 0 ACC_column_23 = 1 ACC_column_22 = 1 ACC_column_21 = 2
0x242E	ACC_column_28 – 4 bits ACC_column_27 – 4 bits ACC_column_26 – 4 bits ACC_column_25 – 4 bits	0xEEFF	ACC_column_28 = -2 ACC_column_27 = -2 ACC_column_26 = -1 ACC_column_25 = -1
0x242F	ACC_column_32 – 4 bits ACC_column_31 – 4 bits ACC_column_30 – 4 bits ACC_column_29 – 4 bits	0xBBDD	ACC_column_32 = -5 ACC_column_31 = -5 ACC_column_30 = -3 ACC_column_29 = -3
0x2430	GAIN	0x18EF	GAIN = 6383
0x2431	PTAT_25	0x2FF1	PTAT_25 = 12273
0x2432	Kv_PTAT - 6 bits Kt_PTAT - 10 bits	0x5952	Kv_PTAT = 0.005371094 Kt_PTAT = 42.25
0x2433	K_Vdd - 8 bits Vdd_25 - 8 bits	0x9D68	K_Vdd = -3168 Vdd_25 = -13056
0x2434	Kv_avg_RO_CO – 4 bits Kv_avg_RE_CO – 4 bits Kv_avg_RO_CE – 4 bits Kv_avg_RE_CE – 4 bits	0x5454	Kv_avg_RO_CO = 5 Kv_avg_RE_CO = 4 Kv_avg_RO_CE = 5 Kv_avg_RE_CE = 4
0x2435	IL_CHESS_C3 – 5 bits IL_CHESS_C2 – 5 bits IL_CHESS_C1 – 6 bits	0x0994	IL_CHESS_C3 = 0.125 IL_CHESS_C2 = 3 IL_CHESS_C1 = 1.25
0x2436	Kta_avg_RO_CO – 8 bits Kta_avg_RE_CO – 8 bits	0x6956	Kta_avg_RO_CO = 105 Kta_avg_RE_CO = 86
0x2437	Kta_avg_RO_CE – 8 bits Kta_avg_RE_CE – 8 bits	0x5354	Kta_avg_RO_CE = 83 Kta_avg_RE_CE = 84
0x2438	Resolution_control_cal – 2 bits Kv_scale – 4 bits Kta_scale_1 – 4 bits Kta_scale_1 – 4 bits	0x2363	Resolution_control_cal = 2 Kv_scale = 3 Kta_scale_1 = 14 Kta_scale_1 = 3
0x2439	CP_SP_1/SP_0_ratio – 6 bits	0xE446	CP_SP_1/SP_0_ratio = -0.0546875

Alpha_CP_SP_0 – 10 bits		Alpha_CP_SP_0 = 4.0745362639427E-09	
0x243A	CP_off_delta (SP_1 - SP_0) – 6 bits Offset_CP_SP_0 – 10 bits	0xFBB5	CP_off_delta (SP_1 - SP_0) = -2 Offset_CP_SP_0 = -75
0x243B	Kv_CP – 8 bits Kta_CP – 8 bits	0x044B	Kv_CP = 0.5 Kta_CP = 0.00457763671875
0x243C	KsTa – 8 bits TGC – 8 bits	0xF020	KsTa = -0.001953125 TGC = 1
0x243D	KsTo2 (0°C...CT3°C) – 8 bits KsTo1 (<0°C) – 8 bits	0x9797	KsTo2 (0°C...CT3°C) = -0.0008010864 KsTo1 (<0°C) = -0.0008010864
0x243E	KsTo4 (CT4°C...) – 8 bits KsTo3 (CT3°C...CT4°C) – 8 bits	0x9797	KsTo4 (CT4°C...) = -0.0008010864 KsTo3 (CT3°C...CT4°C) = -0.0008010864
0x243F	Step – 2 bits CT4 – 4 bits CT3 – 4 bits KsTo_scale – 4 bits	0x2889	Step = 20°C CT4 = 320°C CT3 = 160°C KsTo_scale = 17

Table 12 Calculation example calibration data

11.2.2. Temperature calculation

After the parameters restore the temperature calculation is done using following calculation flow (assuming that the EEPROM data are already extracted):

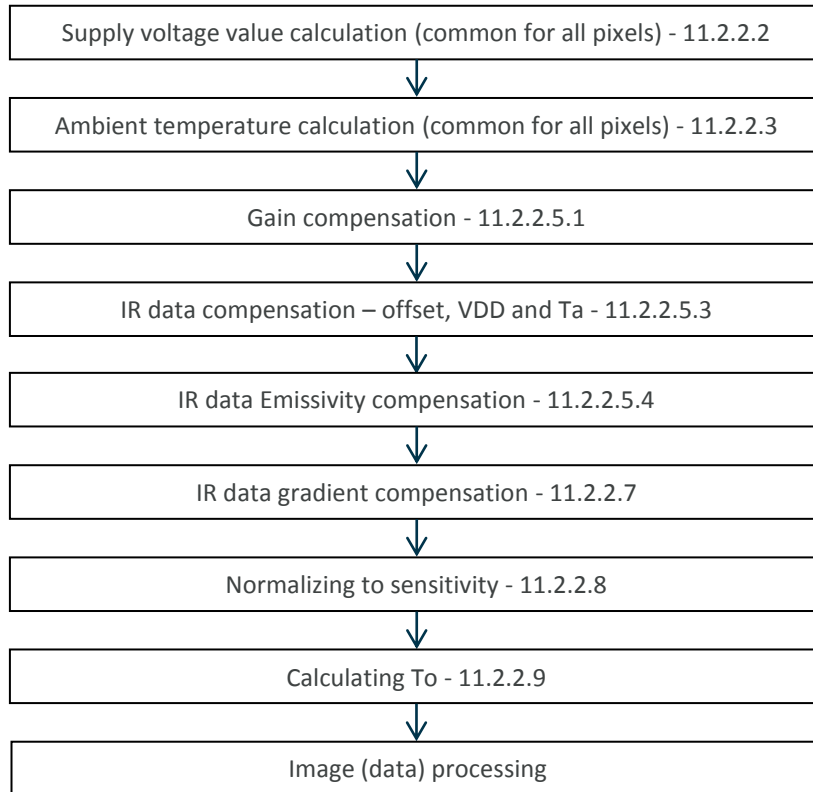

Figure 16 To calculation flow

For this example we calculate the temperature of pixel (12, 16) i.e. row=12 and the column=16.

Values marked with green are extracted from device EEPROM

Values marked with grey are final parameter values or are values to be used for next calculations

11.2.2.1. Resolution restore

The device is calibrated with default resolution setting = 2 (corresponding to ADC resolution set to 18bit see Fig 11) i.e. if the one choose to change the ADC resolution setting to a different one a correction of the data must be done. First we must restore the resolution at which the device has been calibrated which is stored at EEPROM 0x2438.

$$Resolution_{corr} = \frac{2^{Resolution_{EE}}}{2^{Resolution_{REG}}}$$

Where:

$$Resolution_{EE} = \frac{EF10x2438 \& 0x3000}{2^{12}} = \frac{0x236x \& 0x3000}{2^{12}} = 0x0002 = 2 \text{ (unsigned)}$$

$$Resolution_{REG} = \frac{RAM[0x800D] \& 0x0C00}{2^{10}} = \frac{0x1901 \& 0x0C00}{2^{10}} = 0x0002 = 2 \text{ (unsigned)}$$

$$Resolution_{corr} = \frac{2^{Resolution_{EE}}}{2^{Resolution_{REG}}} = \frac{2^2}{2^2} = 1$$

In case the ADC resolution is changed the one must multiply the $Resolution_{corr}$ coefficient with the RAM data for VDD only. Please note that the data for Vbe, PTAT and IR pixels (including CP) **must** not be changed.

11.2.2.2. Supply voltage value calculation (common for all pixels)

$$V_{dd} = \frac{Resolution_{corr} * RAM[0x072A] - V_{dd25}}{K_{Vdd}} + V_{dd0}$$

Where: Constants calculation of the EEPROM stored values (can be done just once after POR)

$$K_{Vdd} = \frac{EE[0x2433] \& 0xFF00}{2^8} = \frac{0x9D68 \& 0xFF00}{2^8} = 0x009D = 157$$

$$\text{If } 157 > 127 \rightarrow K_{Vdd} = 157 - 256 = -99$$

$$K_{Vdd} = K_{Vdd} * 2^5 = -99 * 32 = -3168$$

$$V_{dd25} = EE[0x2433] \& 0x00FF = 0x9D68 \& 0x00FF = 0x0068 = 104$$

$$V_{dd25} = (V_{dd25} - 256) * 2^5 - 2^{13} = -152 * 32 - 8192 = -13056$$

VDD calculations:

$$RAM[0x072A] = 0xCCC5 = 52421$$

$$\text{If } 52883 > 32767 \rightarrow RAM[0x072A] = 52421 - 65536 = -13115 \text{ LSB}$$

$$V_{dd} = \frac{1 * -13115 - (-13056)}{-3168} + 3.3 = \frac{-59}{-3168} + 3.3 \approx 0.0186 + 3.3 \approx 3.319V$$

11.2.2.3. Ambient temperature calculation (common for all pixels)

$$T_a = \frac{\left(\frac{V_{PTAT_{art}}}{1 + K_{V_{PTAT}} * \Delta V} - V_{PTAT_{25}} \right)}{K_{T_{PTAT}}} + 25, \text{ } ^\circ\text{C}$$

Where:

$$K_{V_{PTAT}} = \frac{EE[0x2432] \& 0xFC00}{2^{10}} = \frac{0x5952 \& 0xFC00}{2^{10}} = 0x0016 = 22$$

$$\text{If } 22 < 31 \rightarrow K_{V_{PTAT}} = 22$$

$$K_{V_{PTAT}} = \frac{K_{V_{PTAT}}}{2^{12}} = \frac{22}{4096} = 0.005371094$$

$$K_{T_{PTAT}} = EE[0x2432] \& 0x03FF = 0x5952 \& 0x03FF = 0x0152 = 338$$

$$\text{If } 338 < 511 \rightarrow K_{T_{PTAT}} = 338$$

$$K_{T_{PTAT}} = \frac{K_{T_{PTAT}}}{2^3} = \frac{338}{8} = 42.25$$

$$\Delta V = \frac{RAM[0x072A] - V_{dd25}}{K_{Vdd}}$$

$$RAM[0x072A] = 0xCCC5 = 52421$$

$$\text{If } 52421 > 32767 \rightarrow RAM[0x072A] = 52421 - 65536 = -13115 \text{ LSB}$$

$$\Delta V = \frac{-13115 - (-13056)}{-3168} = \frac{-59}{-3168} \approx 0.018623737$$

$$V_{PTAT_{25}} = 55[0x2431] = 0x2FF1 = 12273$$

$$\text{If } 12273 < 32767 \rightarrow V_{PTAT_{25}} = 12273$$

$$V_{PTAT_{art}} = \left(\frac{V_{PTAT}}{V_{PTAT} * \text{Alpha}_{PTAT} + V_{BE}} \right) * 2^{18}$$

Where:

$$V_{PTAT} = RAM[0x0720] = 0x06AF = 1711$$

$$\text{If } 1711 < 32767 \rightarrow V_{PTAT} = 1711$$

$$V_{BE} = RAM[0x0700] = 0x4BF2 = 19442$$

$$\text{If } 19442 < 32767 \rightarrow V_{BE} = 19442$$

$$\text{Alpha}_{PTAT_{EE}} = \frac{55[0x2410] \& 0xF000}{2^{12}} = \frac{0x2410 \& 0xF000}{2^{12}} = \frac{0x4000}{2^{12}} = \frac{16384}{4096} = 4$$

$$\text{Alpha}_{PTAT} = \frac{\text{Alpha}_{PTAT_{EE}}}{2^2} + 8 = \frac{4}{4} + 8 = 9$$

$$V_{PTAT_{art}} = \left(\frac{V_{PTAT}}{V_{PTAT} * \text{Alpha}_{PTAT} + V_{BE}} \right) * 2^{18} = \left(\frac{1711}{1711 * 9 + 19442} \right) * 2^{18} = 12873.57952$$

$$T_a = \frac{\left(\frac{V_{PTAT_{art}}}{1 + K V_{PTAT} * \Delta V} - V_{PTAT_{25}} \right)}{K T_{PTAT}} + 25 \text{ , } ^\circ\text{C}$$

$$T_a = \frac{\left(\frac{12873.57952}{1 + 0.005371094 * 0.018623737} - 12273 \right)}{42.25} + 25 = 14.18440152 + 25 \approx 39.184 \text{ } ^\circ\text{C}$$

11.2.2.4. Gain parameter calculation (common for all pixels)

$$K_{gain} = \frac{GAIN}{RAM[0x070A]}$$

$$RAM[0x070A] = 0x1881 = 6273$$

$$\text{If } 6273 < 32767 \rightarrow RAM[0x070A] = 6273$$

$$GAIN = 55[0x2430] = 0x1887 = 6383$$

$$\text{If } 6383 < 32767 \rightarrow GAIN = 6383$$

$$K_{gain} = \frac{6383}{6273} = 1.01753546947234$$

Please note that this value is updated every frame and it is the same for all pixels including CP regardless the subpage number

11.2.2.5. Pixel data calculations

The pixel addressing is following the pattern as described in Reading pattern shown in Fig 5:

11.2.2.5.1. Gain compensation

The first step of the data processing on raw IR data is always the gain compensation, regardless of pixel or subpage number.

$$pix_{gain}(12, 16) = RAM[pixel\ data] * K_{gain} = RAM[0x056F] * K_{gain}$$

$$RAM[0x056F] = 0x0261 = 609$$

$$\text{If } 609 < 32767 \rightarrow RAM[0x056F] = 609$$

$$pix_{gain}(12, 16) = 609 * 1.01753546947234 = 619.679100908656$$

11.2.2.5.2. Offset calculation

$$pix_{OS_{ref}}(12,16) = Offset_{average} + OCC_{row_{12}} * 2^{OCC_{scale_{row}}} + OCC_{column_{16}} * 2^{OCC_{scale_{column}}} + offset(12,16) * 2^{OCC_{scale_{remnant}}}$$

$$Offset_{average} = EE[0x2411] = 0xFFBB = 65467$$

$$\text{If } 65467 > 32767 \rightarrow Offset_{average} = 65467 - 65536 = -69$$

As the row=12, we select EEPROM cell 0x2414 ($\pm OCC_{rows_{12}} \dots 08$ (4 x 4bit)) and extract the four most significant bits corresponding to parameter $OCC_{rows_{12}}$. If another row number is selected, the corresponding OCC parameter must be selected.

$$OCC_{row_{12}} = \frac{EE[0x2414] \& 0xF000}{2^{12}} = \frac{0x2414 \& 0xF000}{2^{12}} = 0x000F = 15$$

$$\text{If } 15 > 7 \rightarrow OCC_{row_{12}} = 15 - 16 = -1$$

$$OCC_{scale_{row}} = \frac{EE[0x2410] \& 0x0F00}{2^8} = \frac{0x2410 \& 0x0F00}{2^8} = 0x0002 = 2$$

Please note that $OCC_{scale_{row}}$ is a common parameter for all OCC_{row_i} calculation

As the column=16, we select EEPROM cell 0x2425 ($\pm OCC_{column_{16}} \dots 13$ (4 x 4bit)) and extract the four most significant bits corresponding to parameter $OCC_{column_{16}}$. If another column number is selected, the corresponding OCC parameter must be selected.

$$OCC_{column_{16}} = \frac{EE[0x2425] \& 0xF000}{2^{12}} = \frac{0x2425 \& 0xF000}{2^{12}} = 0x000E = 14$$

$$\text{If } 14 > 7 \rightarrow OCC_{column_{16}} = 14 - 16 = -2$$

$$OCC_{scale_{column}} = \frac{EE[0x2410] \& 0x00F0}{2^4} = \frac{0x2410 \& 0x00F0}{2^4} = 0x0001 = 1$$

Please note that $OCC_{scale_{column}}$ is a common parameter for all OCC_{column_j} calculation

$$offset(12,16) = \frac{EE[0x254F] \& 0xFC00}{2^{10}} = \frac{0x0070 \& 0xFC00}{2^{10}} = 0x0002$$

$$\text{If } 2 < 31 \rightarrow offset(12,16) = 2$$

$$OCC_{scale_remnant} = EE[0x2410] \& 0x000F = 0x4210 \& 0x000F = 0x0000 = 0$$

$$pix_{OS_ref}(12,16) = -69 + (-1) * 2^2 + (-2) * 2^1 + 2 * 2^0 = -69 - 4 - 4 + 2 = -75$$

11.2.2.5.3. IR data compensation – offset, VDD and Ta

$$pix_{OS}(12,16) = pix_{gain}(12,16) - pix_{OS_ref} * \left(1 + K_{Ta(12,16)} * (T_a - T_{a0})\right) * \left(1 + K_{V(12,16)} * (V_{dd} - V_{ddV0})\right)$$

$$K_{Ta(12,16)} = \frac{K_{Ta_RC_EE} + \frac{K_{Ta(12,16)} - EE \& 0x000E}{2} * 2 * K_{Ta_scale_2}}{2^{K_{Ta_scale_1}}}$$

Where:

$$K_{Ta(12,16)_EE} = \frac{EE[0x254F] \& 0x000E}{2} = \frac{0x0070 \& 0x000E}{2} = 0x0000 = 0$$

$$\text{If } 0 < 3 \rightarrow K_{Ta(12,16)_EE} = 0$$

As row and column numbers are even then

$$K_{Ta_RC_EE} = EE[0x2437] \& 0x00FF = 0x5354 \& 0x00FF = 0x0054 = 84$$

$$\text{If } 84 < 127 \rightarrow K_{Ta_RC_EE} = 84$$

$$K_{Ta_scale_1} = \frac{EE[0x2438] \& 0x00F0}{2^4} + 8 = \frac{0x2363 \& 0x00F0}{2^4} + 8 = 0x0006 + 8 = 6 + 8 = 14$$

$$K_{Ta_scale_2} = EE[0x2438] \& 0x000F = 0x2363 \& 0x000F = 0x0003 = 3$$

$$K_{Ta(12,16)} = \frac{84 + 0 * 2^3}{2^{14}} = \frac{84}{16384} = 0.005126953125$$

As row and column numbers are even:

$$K_{V(i,j)} = EE[0x2434] \& 0x000F = 0x5454 \& 0x000F = 0x0004 = 4$$

$$\text{If } K_{V(i,j)} < 7 \rightarrow K_{V(i,j)} = 4$$

$$K_{V(12,16)} = \frac{K_{V(i,j)}}{2^{K_{V_scale}}} \text{ (signed)}$$

Where:

$$K_{V_scale} = \frac{EE[0x2438] \& 0x0F00}{2^8} = \frac{0x2363 \& 0x0F00}{2^8} = 0x0003 = 3$$

$$K_{V(12,16)} = \frac{K_{V(i,j)}}{2^{K_{V_scale}}} = \frac{4}{2^3} = \frac{4}{8} = 0.5$$

$$pix_{OS}(12,16) = 619.679100908656 - (-75) * \left(1 + 0.005126953125 * (39.184 - 25)\right) * \left(1 + 0.5 * (3.319 - 3.3)\right)$$

$$pix_{OS}(12,16) = 700.882495690877$$

11.2.2.5.4. IR data Emissivity compensation

Emissivity compensation: For the example we assume Emissivity = 1. Note that the Emissivity coefficient is user defined and it is not stored in the device EEPROM)

$$V_{IR(12,16)Emissivity_COMPENSATED} = \frac{pix_{OS(12,16)}}{\epsilon} = \frac{700.882495690877}{1} = 700.882495690877$$

11.2.2.6. CP data calculations

11.2.2.6.1. Compensating the GAIN of CP pixel

$$pix_{gain_CP_SP0} = RAM[0x0708] * K_{gain}$$

$$RAM[0x0708] = 0xFFCA = 65482$$

$$\text{If } 65482 > 32767 \rightarrow RAM[0x0708] = 65482 - 65536 = -54$$

$$pix_{gain_CP_SP0} = -54 * 1.001753546947234 = -54.9469153515065$$

$$pix_{gain_CP_SP1} = RAM[0x0728] * K_{gain}$$

$$RAM[0x0728] = 0xFFC8 = 65480$$

$$\text{If } 65480 > 32767 \rightarrow RAM[0x0728] = 65480 - 65536 = -56$$

$$pix_{gain_CP_SP1} = -56 * 1.001753546947234 = -56.9819862904511$$

NOTE: In order to limit the noise in the final T_o calculation it is advisable to filter the CP readings at this point of calculation. A good practice would be to apply a Moving Average Filter with length of 16 or higher.

11.2.2.6.2. Compensating offset, T_a and VDD of CP pixel

$$pix_{OS_CP_SP0} = pix_{gain_CP_SP0} - Off_CP_{subpage_0} * (1 + K_{Ta_CP} * (T_a - T_{a0})) * (1 + K_{V_CP} * (V_{dd} - V_{ddV0}))$$

The value of the offset for compensating pixel for the subpage 1 depends on the reading pattern. In case the chess reading pattern mode is used following formula is to be applied:

$$pix_{OS_CP_SP1} = pix_{gain_CP_SP1} - Off_CP_{subpage_1} * (1 + K_{Ta_CP} * (T_a - T_{a0})) * (1 + K_{V_CP} * (V_{dd} - V_{ddV0}))$$

In case of interleaved mode is used following formula is to be applied:

$$pix_{OS_CP_SP1} = pix_{gain_CP_SP1} - Off_CP_{subpage_1} + IL_{CHESS_C1} * (1 + K_{Ta_CP} * (T_a - T_{a0})) * (1 + K_{V_CP} * (V_{dd} - V_{ddV0}))$$

The correction parameter (highlighted in yellow) is extracted in 11.1.3.1

Where:

$$Off_CP_{subpage_0} = EE[0x243A] \& 0x03FF = 0xFBB5 \& 0x03FF = 0x03B5 = 949$$

$$\text{If } 949 > 511 \rightarrow Off_CP_{subpage_0} = 949 - 1024 = -75$$

$$Off_CP_{subpage_1} = Off_CP_{subpage_0} + Off_CP_{subpage_1_delta}$$

Where:

$$Off_CP_{subpage_1_delta} = \frac{EE[0x243B] \& 0xFC00}{2^{10}} = \frac{0x243B \& 0xFC00}{2^{10}} = 0x003E = 62$$

$$\text{If } 62 > 31 \rightarrow Off_CP_{subpage_1_delta} = 62 - 64 = -2$$

$$Off_CP_{subpage_1} = -75 + (-2) = -77$$

$$K_{T_{a_{CP}}} = \frac{K_{T_{a_{CP_EE}}}}{2^{K_{T_{a_{scale_1}}}}} = \frac{75}{2^{14}} = 0.00457763671875$$

Where:

$$K_{T_{a_{scale_1}}} = \frac{EE[0x243B] \& 0x00F0}{2^4} + 8 = 14 \text{ (unsigned) (the same one as for the } K_{T_{a(i,j)}} \text{ coefficients)}$$

$$K_{T_{a_{CP_EE}}} = EE[0x243B] \& 0x00FF = 0x044B \& 0x00FF = 0x004B = 75$$

$$\text{If } 75 < 127 \rightarrow K_{T_{a_{CP_EE}}} = 75$$

$$K_{V_{CP}} = \frac{K_{V_{CP_EE}}}{2^{K_{V_{scale}}}} = \frac{4}{2^3} = 0.5$$

$$K_{V_{scale}} = \frac{EE[0x243B] \& 0x0F00}{2^8} = \frac{0x243B \& 0x0F00}{2^8} = 0x0003 = 3 \text{ (unsigned) (the same one as for the } K_{V(i,j)} \text{ coefficients)}$$

Where:

$$K_{V_{CP_EE}} = \frac{EE[0x243B] \& 0xFF00}{2^8} = \frac{0x044B \& 0xFF00}{2^8} = 0x0004 = 4$$

$$\text{If } 4 < 127 \rightarrow K_{V_{CP_EE}} = 4$$

$$pix_{OS_CP_SP0} = -54.9469153515065 - (-75) * (1 + 0.00457763671875 * (39.184 - 25)) * (1 + 0.5 * (3.319 - 3.3))$$

$$pix_{OS_CP_SP0} = 25.6666575059956$$

$$pix_{OS_CP_SP1} = -56.9819862904511 - (-77) * (1 + 0.00457763671875 * (39.184 - 25)) * (1 + 0.5 * (3.319 - 3.3))$$

$$pix_{OS_CP_SP1} = 21.6315865670509$$

11.2.2.7. IR data gradient compensation

As stated in “Reading patterns” the device can work in two different readings modes (Chess pattern – the default one and IL (Interleave mode)).

Depending on the device measurement mode and $pixel_{number} = 1 \dots 768$ we can define a pattern which will help us to automatically switch between both subpages.

- In case of **Chess pattern** is selected please use following expression:

$$Pattern = \left(\text{int} \left(\frac{pixel_{number} - 1}{32} \right) - \text{int} \left(\frac{\text{int} \left(\frac{pixel_{number} - 1}{32} \right)}{2} \right) * 2 \right) \text{ xor} \left((pixel_{number} - 1) - \text{int} \left(\frac{pixel_{number} - 1}{2} \right) * 2 \right)$$

- In case of **Interleaved pattern** please use following expression:

$$Pattern = \left(\text{int} \left(\frac{pixel_{number} - 1}{32} \right) - \text{int} \left(\frac{\text{int} \left(\frac{pixel_{number} - 1}{32} \right)}{2} \right) * 2 \right)$$

Where the *int* function is giving the truncated whole number without fractional component of the result.

Where *xor* is *exclusive or* or *exclusive disjunction* is a logical operation that outputs true only when inputs differ. The truth table is as follows:

Input 1	Input 2	Output
0	0	0
0	1	1
1	0	1
1	1	0

Table 13 XOR truth table

Example: Let's assume that the $pixel_{number} = 368$ (12x16)

If we are in chess mode:

$$Pattern = \left(\text{int} \left(\frac{368 - 1}{32} \right) - \text{int} \left(\frac{\text{int} \left(\frac{368 - 1}{32} \right)}{2} \right) * 2 \right) \text{xor} \left((368 - 1) - \text{int} \left(\frac{368 - 1}{2} \right) * 2 \right)$$

$$Pattern = \left(\text{int}(11.46875) - \text{int} \left(\frac{\text{int}(11.46875)}{2} \right) * 2 \right) \text{xor} (367 - \text{int}(183.5) * 2)$$

$$Pattern = \left(11 - \text{int} \left(\frac{11}{2} \right) * 2 \right) \text{xor} (367 - 183 * 2) = (11 - 5 * 2) \text{xor} (1) = (1) \text{xor} (1) = 0$$

If we are in IL mode:

$$Pattern = \left(\text{int} \left(\frac{368 - 1}{32} \right) - \text{int} \left(\frac{\text{int} \left(\frac{368 - 1}{32} \right)}{2} \right) * 2 \right) = \left(\text{int}(11.46875) - \text{int} \left(\frac{\text{int}(11.46875)}{2} \right) * 2 \right)$$

$$Pattern = \left(11 - \text{int} \left(\frac{11}{2} \right) * 2 \right) = (11 - 5 * 2) = 1$$

$$V_{IR(12,16)COMPENSATED} = V_{IR(12,16)Emissivity_COMPENSATED} - TGC * \left((1 - Pattern) * pix_{OS_CP_SP0} + Pattern * pix_{OS_CP_SP1} \right)$$

$$TGC = \frac{TGC_{EE}}{2^5} = \frac{32}{32} = 1$$

Where:

$$TGC_{EE} = EE[0x243C] \& 0x00FF = 0x7020 \& 0x00FF = 0x0020 = 32$$

$$\text{If } 32 < 127 \rightarrow TGC_{EE} = 32$$

$$V_{IR(12,16)COMPENSATED} = 700.882495690877 - 1 * 21.6315865670509 = 679.250909123826$$

11.2.2.8. Normalizing to sensitivity

$$\alpha_{comp(12,16)} = \left(\alpha_{(12,16)} - TGC * \left((1 - Pattern) * \alpha_{CP_subpage_0} + Pattern * \alpha_{CP_subpage_1} \right) \right) * (1 + K_{STa} * (T_a - T_{a0}))$$

$$\alpha_{CP_subpage_0} = \frac{EE[0x2439] \& 0x03FF}{2^{\alpha_{scale_CP}}} = \frac{0x2446 \& 0x03FF}{2^{\alpha_{scale_CP}}} = \frac{0x2446 \& 0x03FF}{2^{34}} = \frac{0x0046}{2^{34}} = 4.07453626394272E - 09$$

$$\alpha_{CP_subpage_1} = \alpha_{CP_subpage_0} * \left(1 + \frac{CP_P1_P0_ratio}{2^7} \right) = 4.07453626394272E - 09 * \left(1 + \frac{-7}{2^7} \right)$$

$$\alpha_{CP_subpage_1} = 3.85171006200835E - 09$$

Where:

$$\alpha_{scale_CP} = \frac{EE[0x2420] \& 0xF000}{2^{12}} + 27 = \frac{0x79A6 \& 0xF000}{2^{12}} + 27 = 0x0007 + 27 = 34$$

$$CP_P1_P0_ratio = \frac{EE[0x2439] \& 0xFC00}{2^{10}} = \frac{0x2446 \& 0xFC00}{2^{10}} = 0x0039 = 57$$

$$\text{If } 57 > 31 \rightarrow CP_P1_P0_ratio = 57 - 64 = -7$$

$$K_{STa} = \frac{K_{STa_EE}}{2^{13}} = \frac{-16}{2^{13}} = -0.001953125$$

Where:

$$K_{STa_EE} = \frac{EE[0x2439] \& 0xFF00}{2^8} = \frac{0x79A6 \& 0xFF00}{2^8} = 0x00F0 = 240 \text{ (common for all pixels)}$$

$$\text{If } 240 > 127 \rightarrow K_{STa_EE} = 240 - 256 = -16$$

$$\alpha_{(12,16)} = \frac{\alpha_{reference} + ACC_{row_{12}} * 2^{ACC_{scale_row}} + ACC_{column_{16}} * 2^{ACC_{scale_column}} + \alpha_{pixel(12,16)} * 2^{ACC_{scale_remnant}}}{2^{\alpha_{scale}}}$$

Where:

$$\alpha_{reference} = EE[0x2421] = 0x2F44 = 12100$$

$$\alpha_{scale} = \frac{EE[0x2420] \& 0xF000}{2^{12}} + 30 = \frac{0x79A6 \& 0xF000}{2^{12}} + 30 = 0x0007 + 30 = 37$$

$$ACC_{row_{12}} = \frac{EE[0x242A] \& 0xF000}{2^{12}} = \frac{0x3333 \& 0xF000}{2^{12}} = 0x0003 = 3$$

$$\text{If } 3 < 7 \rightarrow ACC_{row_{12}} = 3$$

$$ACC_{scale_row} = \frac{EE[0x2420] \& 0xF00}{2^8} = \frac{0x79A6 \& 0xF00}{2^8} = 0x0009 = 9$$

$$ACC_{column_{16}} = \frac{EE[0x242B] \& 0xF000}{2^{12}} = \frac{0x3333 \& 0xF000}{2^{12}} = 0x0003 = 3$$

$$\text{If } 3 > 7 \rightarrow ACC_{column_{16}} = 3$$

$$ACC_{scale_column} = \frac{EE[0x2420] \& 0x00F0}{2^4} = \frac{0x79A6 \& 0x00F0}{2^4} = 0x000A = 10$$

$$\alpha_{pixel(12,16)} = \frac{EE[0x258F] \& 0x03F0}{2^4} = \frac{0x0840 \& 0x03F0}{2^4} = 0x000A = 10$$

$$\text{If } 10 < 31 \rightarrow \alpha_{pixel(12,16)} = 10$$

$$ACC_{scale_remnant} = EE[0x2420] \& 0x000F = 0x79A6 \& 0x000F = 0x0006 = 6$$

$$\alpha_{(12,16)} = \frac{12100+3*2^9+3*2^{10}+10*2^6}{2^{37}} = 1.26223312690854E - 07$$

$$\alpha_{comp(12,16)} = \left(\alpha_{(12,16)} - TGC * \left((1 - Pattern) * \alpha_{CP_subpage_0} + Pattern * \alpha_{CP_subpage_1} \right) \right) * (1 + K_{STa} * (T_a - T_{a0}))$$

$$\alpha_{comp(12,16)} = (1.26223312690854E - 07 - 1 * ((1 - 0) * 4.07453626394272E - 09 + 0 * 3.85171006200835E - 09)) * (1 + -0.001953125 * (39.184 - 25))$$

$$\alpha_{comp(12,16)} = 1.1876487360496E - 07$$

11.2.2.9. Calculating To for basic temperature range (0°C...CT3 °C)

$$K_{STo2} = \frac{K_{STo2_EE}}{2^{K_{STo_scale}}} = \frac{-105}{2^{17}} = -0.00080108642578125$$

Where:

$$K_{STo2_EE} = \frac{EE[0x2430] \& 0xFF00}{2^8} = \frac{0x2430 \& 0xFF00}{2^8} = 0x0097 = 151$$

$$\text{If } 151 > 127 \rightarrow K_{STo2_EE} = 151 - 256 = -105$$

$$K_{STo_scale} = EE[0x243F] \& 0x000F + 8 = 0x2889 \& 0x000F + 8 = 0x0009 + 8 = 17$$

As the IR signal received by the sensor has two components:

1. IR signal emitted by the object
2. IR signal reflected from the object (the source of this signal is surrounding environment of the sensor)

In order to compensate correctly for the emissivity and achieve best accuracy we need to know the surrounding temperature which is responsible for the second component of the IR signal namely the reflected part - T_r . In case this T_r temperature is not available and cannot be provided it might be replaced by $T_r \approx T_a - 8$.

Let's assume $T_r = 31^\circ\text{C}$.

$$T_{aK4} = (T_a + 273.15)^4 = (39.184 + 273.15)^4 = 312.334^4 = 9516495632.56$$

$$T_{rK4} = (T_r + 273.15)^4 = (31 + 273.15)^4 = 304.15^4 = 8557586214.66$$

$$T_{a-r} = T_{rK4} - \frac{T_{rK4} - T_{aK4}}{\varepsilon} = 8557586214.66 - \frac{8557586214.66 - 9516495632.56}{1} = 9516495632.56$$

$$S_{x(12,16)} = K_{STo2} * \sqrt[4]{\alpha_{comp(12,16)}^3 * V_{IR(12,16)COMPENSATED} + \alpha_{comp(12,16)}^4 * T_{a-r}}$$

$$S_{x(12,16)} = -0.00080108642578125 * \sqrt[4]{(1.1876487360496E - 07)^3 * 679.250909123826 + (1.1876487360496E - 07)^4 * 9516495632.56}$$

$$S_{x(12,16)} = -3.34259382357449E - 08$$

$$T_{O(12,16)} = \sqrt[4]{\frac{V_{IR(12,16)COMPENSATED}}{\alpha_{comp(12,16)} * (1 - K_{STo2} * 273.15)} + T_{a-r} - 273.15}$$

$$T_{O(12,16)} = \sqrt[4]{\frac{679.250909123826}{1.1876487360496E - 07 * (1 - (-0.00080108642578125) * 273.15)} + 9516495632.56 - 273.15}$$

$$T_{O(12,16)} = 80.363312506592 \approx 80.36, ^\circ\text{C}$$

11.2.2.9.1. Calculations for extended temperature ranges

In order to extend the object temperature range and get the best possible accuracy an additional calculation cycle is needed. We can identify 4 object temperature ranges (each temperature range has its own so called Corner Temperature – CT which is the temperature at which the range starts):

- Object temperature range 1 = -40°C ... 0°C (Corner temperature for this range is -40°C and cannot be changed)
- Object temperature range 2 = 0°C ... CT3°C (Corner temperature for this range is 0°C and cannot be changed)
- Object temperature range 3 = CT3°C ... CT4°C
- Object temperature range 4 = CT4°C ...

In order to be able to carry out temperature calculation for the ranges outside of temperature range 2 (To = 0°C...CT3) an additional parameters are needed and must be extracted from the device EEPROM. Those parameters are:

- So called corner temperature (CTx) i.e. the value of temperature at the beginning of the range. Please note that the corner temperatures for range 1 is fixed to -40°C and corner temperatures for range 2 is fixed to 0°C while CT3 and CT4 are adjustable
- Sensitivity slope for each range – K_{STo_x}
- $T_{O(x,y)}$ calculated in 11.2.2.9

11.2.2.9.1.1. Restoring corner temperatures

The information regarding corner temperatures is stored into device EEPROM and is restored as follows:

$$Step = \frac{EE[0x243F] \& 0x3000}{2^{12}} * 10 = \frac{0x2889 \& 0x3000}{2^{12}} * 10 = 0x0002 * 10 = 2 * 10 = 20^{\circ}C$$

$$CT3 = \frac{EE[0x243F] \& 0x00F0}{2^4} * Step = \frac{0x2889 \& 0x00F0}{2^4} * 20 = 0x0008 * 20 = 8 * 20 = 160^{\circ}C$$

$$CT4 = \frac{EE[0x243F] \& 0x0F00}{2^8} * Step + CT3 = \frac{0x2889 \& 0x0F00}{2^8} * 20 + 160 = 0x0008 * 20 + 160 = 8 * 20 + 160 = 320^{\circ}C$$

Or we can construct the temperatures for the ranges as follows:

$$CT1 = -40^{\circ}C < \text{Range 1} > CT2 = 0^{\circ}C < \text{Range 2} > CT3 = 160^{\circ}C < \text{Range 3} > CT4 = 320^{\circ}C < \text{Range 4}$$

11.2.2.9.1.2. Restoring the sensitivity slope for each range

$K_{STo_{scale}} = 17$ has been extracted in 11.1.10

$$K_{STo1} = \frac{K_{STo1_EE}}{2^{K_{STo_{scale}}}} = \frac{-105}{2^{17}} = -0.00080108642578125$$

Where:

$$K_{STo1_EE} = EE[0x243D] \& 0x00FF = 0x9797 \& 0x00FF = 0x0097 = 151 \text{ (signed)}$$

$$\text{If } K_{STo1_EE} > 127 \rightarrow K_{STo1_EE} = K_{STo1_EE} - 256 = 151 - 256 = -105$$

$$K_{STo3} = \frac{K_{STo3_EE}}{2^{K_{STo_{scale}}}} = \frac{-105}{2^{17}} = -0.00080108642578125$$

Where:

$$K_{STo3_EE} = EE[0x243E] \& 0x00FF = 0x9797 \& 0x00FF = 0x0097 = 151 \text{ (signed)}$$

$$\text{If } K_{S_{T_{03_EE}}} > 127 \rightarrow K_{S_{T_{03_EE}}} = K_{S_{T_{03_EE}}} - 256 = 151 - 256 = -105$$

$$K_{S_{T_{04}}} = \frac{K_{S_{T_{04_EE}}}}{2^{K_{S_{T_{04_scale}}}}} = \frac{-105}{2^{17}} = -0.00080108642578125$$

Where:

$$K_{S_{T_{04_EE}}} = \frac{EE[0x243E] \& 0x00FF}{2^8} = \frac{0x0097 \& 0xFF00}{2^8} = 0x0097 = 151 \text{ (signed)}$$

$$\text{If } K_{S_{T_{04_EE}}} > 127 \rightarrow K_{S_{T_{04_EE}}} = K_{S_{T_{04_EE}}} - 256 = 151 - 256 = -105$$

Now we can calculate sensitivity correction coefficients for each temperature range:

$$Alpha_{corr_{range1}} = \frac{1}{(1 + K_{S_{T_{01}}} * (0 - (-40)))} = \frac{1}{(1 - 0.00080108642578125 * (0 - (-40)))} = 1.033104231$$

$$Alpha_{corr_{range2}} = 1$$

$$Alpha_{corr_{range3}} = 1 + K_{S_{T_{02}}} * (CT3 - 0) = 1 - 0.00080108642578125 * (160 - 0) = 0.871826172$$

$$Alpha_{corr_{range4}} = (1 + K_{S_{T_{02}}} * (CT3 - 0)) * (1 + K_{S_{T_{03}}} * (CT4 - CT3))$$

$$Alpha_{corr_{range4}} = (1 - 0.00080108642578125 * (160 - 0)) * (1 - 0.00080108642578125 * (320 - 160))$$

$$Alpha_{corr_{range4}} = 0.76008087418$$

11.2.2.9.1.3. Extended To range calculation

The input parameter for this calculation is the object temperature calculated in 11.2.2.9

If $T_{O(12,16)} < 0^{\circ}\text{C}$ we are in range 1 and we will use the parameters ($K_{S_{T_{01}}}$, $Alpha_{corr_{range1}}$ and $CT1 = -40^{\circ}\text{C}$)

If $0^{\circ}\text{C} < T_{O(12,16)} < CT3^{\circ}\text{C}$ we are in range 2 and we will use the parameters ($K_{S_{T_{02}}}$, $Alpha_{corr_{range2}}$ and $CT2 = 0^{\circ}\text{C}$)

If $CT3^{\circ}\text{C} < T_{O(12,16)} < CT4^{\circ}\text{C}$ we are in range 3 and we will use the parameters ($K_{S_{T_{03}}}$, $Alpha_{corr_{range3}}$ and $CT3 = 160^{\circ}\text{C}$)

If $CT4^{\circ}\text{C} < T_{O(12,16)}$ we are in range 4 and we will use the parameters ($K_{S_{T_{04}}}$, $Alpha_{corr_{range4}}$ and $CT4 = 320^{\circ}\text{C}$)

$$T_{O_{extra_range(12,16)}} = \sqrt[4]{\frac{V_{IR(12,16)_{COMPENSATED}}}{\alpha_{comp(12,16)} * Alpha_{corr_{rangeX}} * (1 + K_{S_{T_{0X}}} * (T_{O(12,16)} - CT_X))}} + T_{a-r} - 273.15$$

12. Performance graphs

12.1. Accuracy

12.1.1. Pixel accuracy

All accuracy specifications apply under settled isothermal conditions only.

Furthermore, the accuracy is only valid if the object fills the FOV of the sensor completely.

Parameter definitions:

Frame accuracy is defined as average value of the all (768) pixels in the frame or for frame n can be expressed as:

$$\overline{T_{o_frame(n)}} = \frac{1}{768} \sum_{m=1}^{768} T_o(m, n)$$

$$Frame\ accuracy = \overline{T_{o_frame(n)}} - T_{target}$$

Non-uniformity is defined as the maximum deviation of each individual pixel reading vs. the absolute accuracy.

$$Non\ Uniformity = MAX(|T_o(m) - \overline{T_{o_frame(n)}}|)$$

Pixel absolute accuracy is defined as:

$$T_{O_accuracy(n)} = Frame\ accuracy + Non\ Uniformity$$

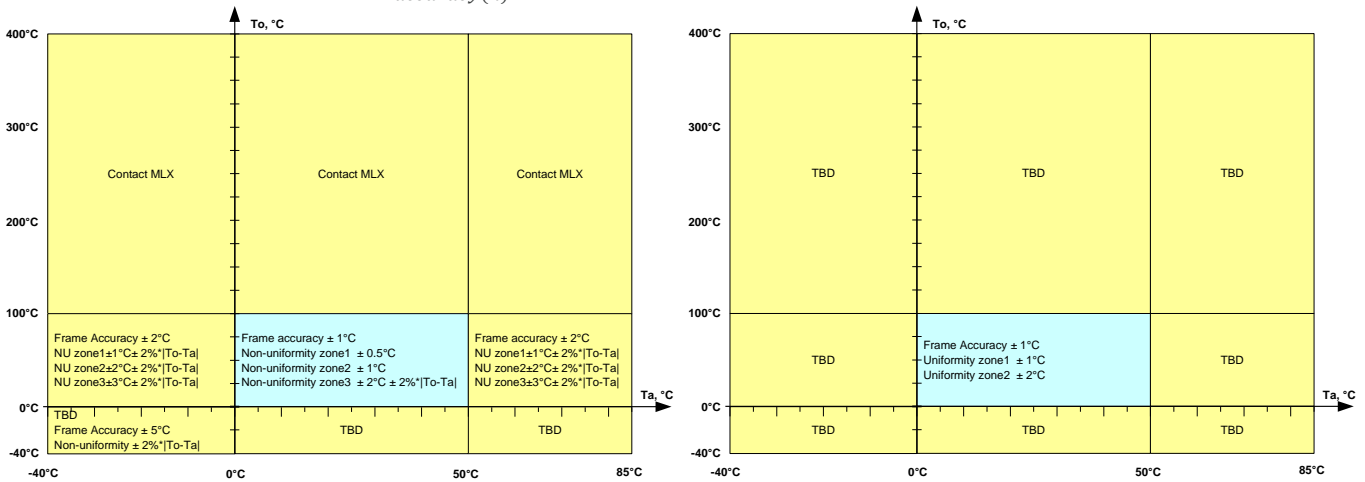

Figure 17 Absolute temperature accuracy – MLX90640BAA (left) and MLX90640BAB (right)

Example: If we assume that the sensor (BAA type, zone 1) is measuring a target at 80°C that would mean that there should be no pixel with error bigger than:

$$T_{O_accuracy(n)} = Frame\ accuracy + Non\ Uniformity = \pm 1 \pm 0.5 = \pm 1.5^\circ C$$

NOTES:

- 1) For best performance it is recommended to keep the supply voltage as accurate and stable as possible to 3.3V ± 0.05V
- 2) As a result of long term (years) drift there can be an additional measurement deviation of ± 3°C for object temperatures around room temperature.

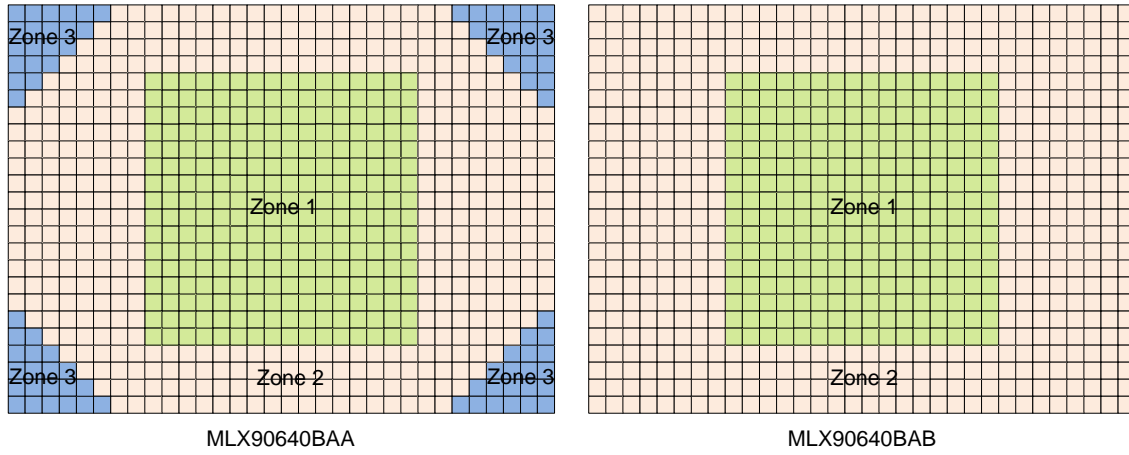

Figure 18 Different accuracy zones depending on device type (BAA on the left and BAB on the right)

12.1.2. Ta accuracy

Absolute accuracy for the Ta channel (die temperature):

$$T_{Accuracy} = \pm 0.5^{\circ}C$$

NOTE: Actual sensor surrounding temperature would be approximately 8°C lower

12.2. Startup time

12.2.1. First valid data

After POR the first valid data is available after (depending on the selected refresh rate) T_{valid_data} which is calculated as:

$$T_{valid_data} = 40 + 500, \text{ ms} \quad (\text{Example refresh rate is 2Hz – the default value})$$

It is always subpage 0 to be measured first after POR then subpage 1 and so on alternating.

NOTE: In case one changes the refresh rate on the fly (by writing new values into device register (0x800D)) the settings will take place only after the subpage under measurement is finished.

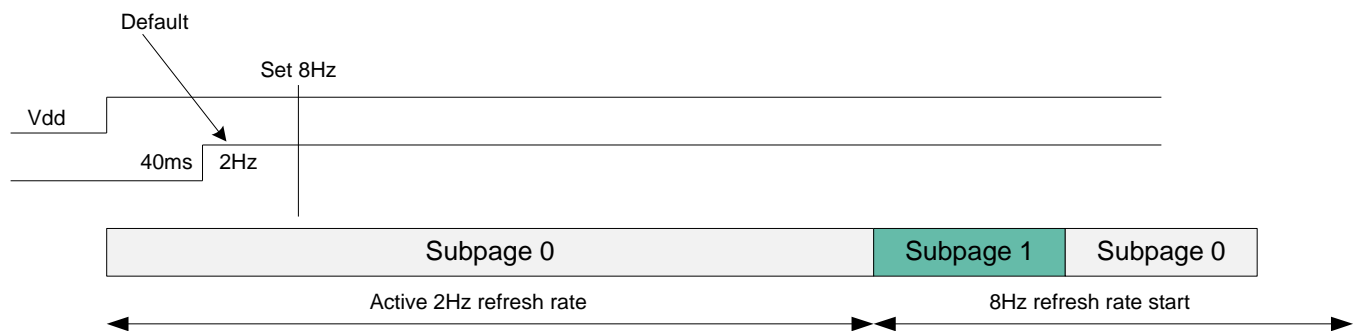

12.2.2. Thermal behavior

Although electrically the device is set and running there is thermal stabilization time necessary before the device can reach the specified accuracy – up to 4 min.

12.3. Noise performance and resolution

There are two bits in the configuration register that allow changing the resolution of the MLX90640 measurements. Increasing the resolution decreases the quantization noise and improves the overall noise performance. Measurement conditions for the noise are: $T_o = T_a = 25^\circ\text{C}$

NOTE: Due to the nature of the thermal infrared radiation, it is normal that the noise will decrease for high temperature and increase for lower temperatures

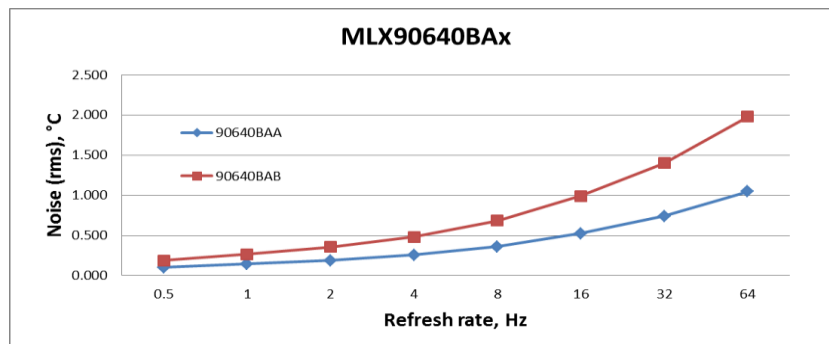

Figure 19 MLX90640BAx noise vs refresh rate for different device types

Not all pixels have the same noise performance. Because of the optical performance of the integrated lens, it is normal that the pixels in the corner of the frame are noisier in comparison with the sensors in the middle. The graphs below show the distribution of the noise density versus the pixel position in the frame (pixel number)

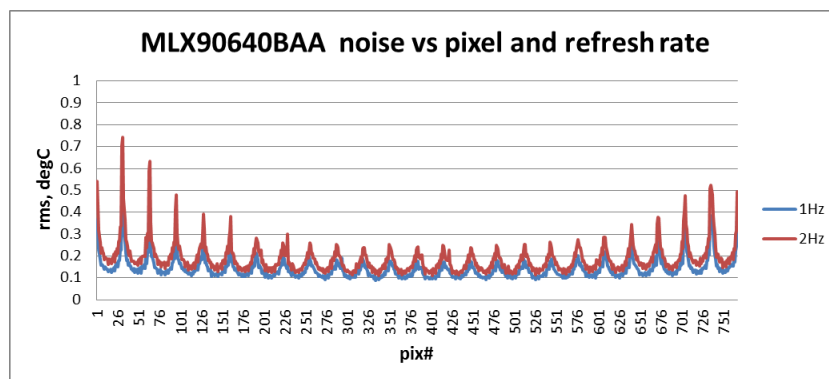

Figure 20 MLX90640BAA noise vs pixel and refresh rate at 1Hz and 2Hz

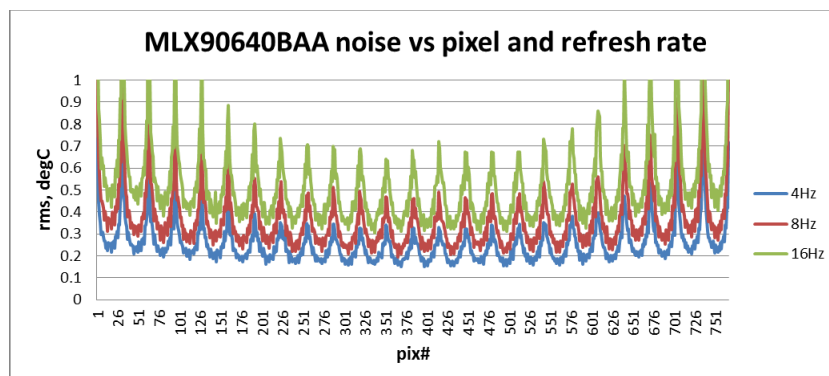

Figure 21 MLX90640BAA noise vs pixel and refresh rate at 4Hz, 8Hz and 16Hz

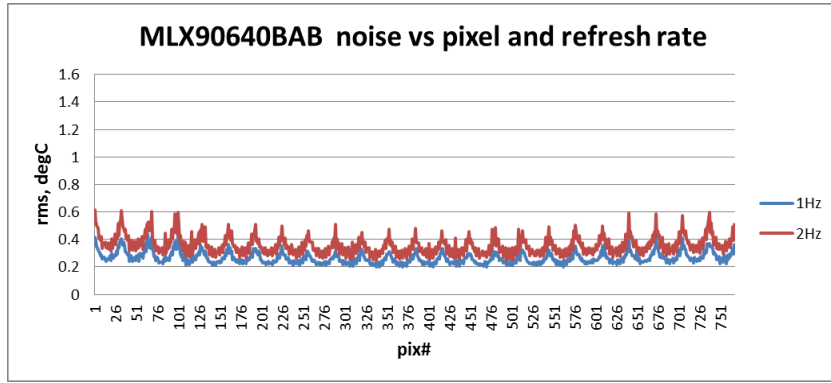

Figure 22 MLX90640BAB noise vs pixel and refresh rate at 1Hz and 2Hz

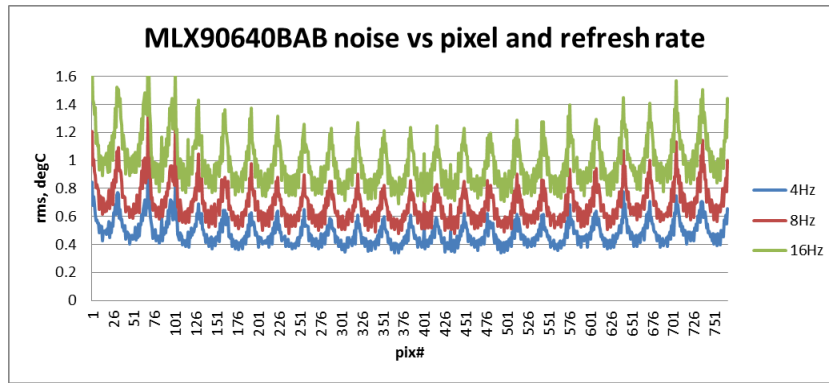

Figure 23 MLX90640BAB noise vs pixel and refresh rate at 4Hz, 8Hz and 16Hz

NETD (K)	1Hz RMS noise (temperature equivalent), all pixels		
MLX90640	Average	Min	Standard deviation
BAA	0.14	0.1	0.05
BAB	0.25	0.2	0.05

Table 14 Noise performance

12.4. Field of view (FOV)

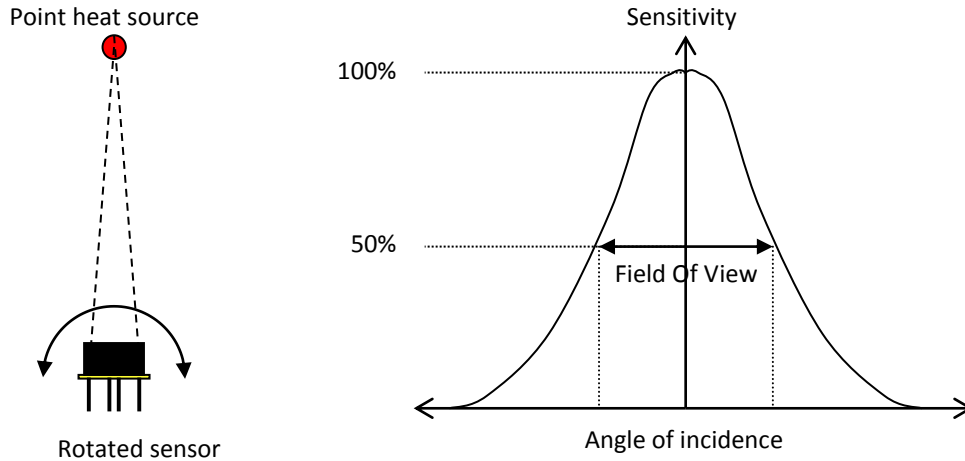

Figure 24 Field Of View measurement

The specified FOV is calculated for the wider direction, in this case for the 32 pixels.

FOV	X direction	Y direction	Central pointing from normal (X & Y direction)
	Typ	Typ	Max
MLX90640-ESF-BAA	110°	75°	5°
MLX90640-ESF-BAB	55°	35°	3°

Table 15 Available FOV options

13. Application information

13.1. Optical considerations

As this is an optical device a care must be taking such that the device performs according to the specification. One such parameter is FOV obstruction. It is paramount that the FOV in the optical path is kept clear. The external aperture is designed such to shape the FOV of the device and is installed prior calibration process thus can be considered as part of the device which does not impact the performance but may be used as a reference for the so called “Optical free zone” – see Figure 27 hereafter.

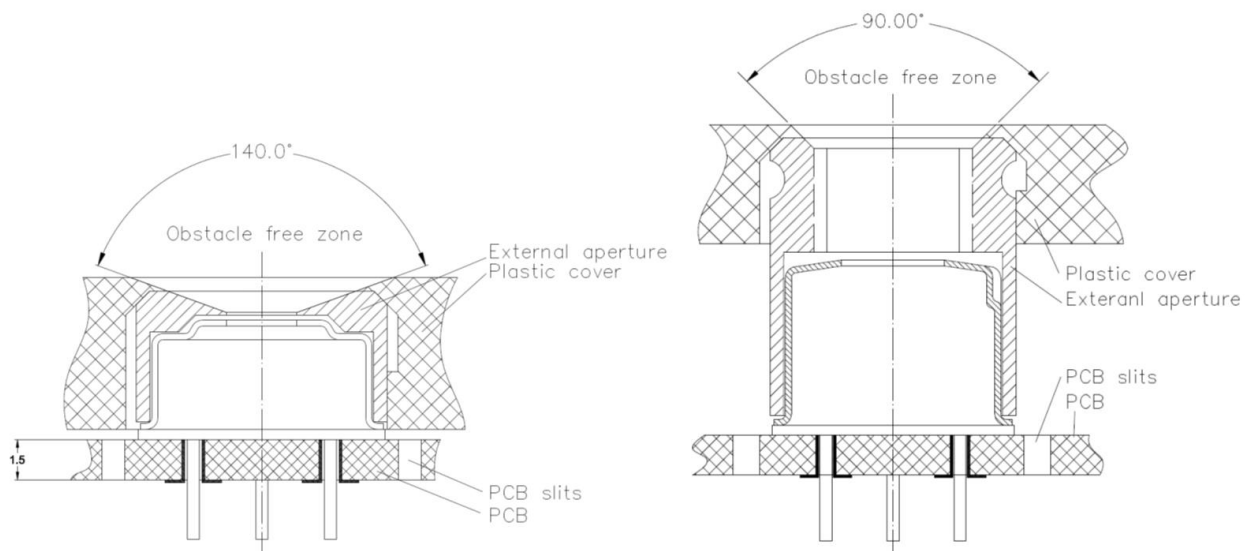

Figure 25 Application examples concerning the optical consideration

13.2. Electrical considerations

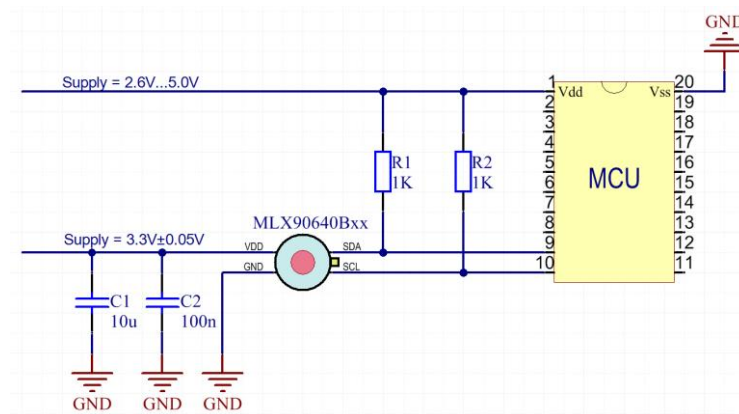

Figure 26 MLX90640 electrical connections

As the MLX90640Bxx is fully I2C compatible it allows to have a system in which the MCU may be supplied with VDD=2.6V...5V while the sensor it's self is supplied from separate supply VDD1=3.3V (or even left with no supply i.e. VDD=0V), **with the I2C connection running at supply voltage of the MCU.**

13.3. Using the device in “image mode”

In some applications may not be necessary to calculate the temperature but rather to have just an image (for instance in machine vision systems). In this case it is not necessary to carry out all calculations which would save computation time or allow the one to use weaker CPU.

In order to get thermal image only following computation flow is to be used:

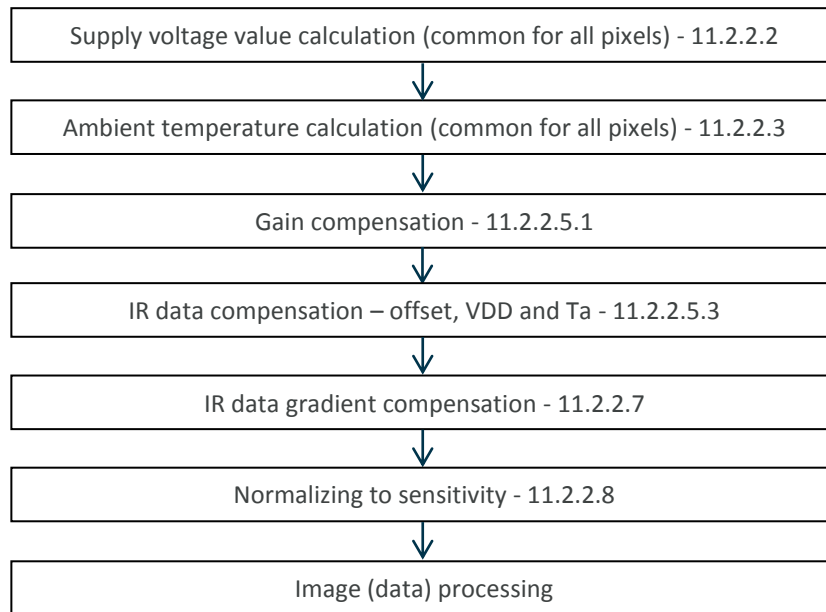

Figure 27 Calculation flow in thermal image mode

14. Application Comments

Significant **contamination** at the optical input side (sensor filter) might cause unknown additional filtering/distortion of the optical signal and therefore result in unspecified errors.

IR sensors are inherently susceptible to errors caused by **thermal gradients**. There are physical reasons for these phenomena and, in spite of the careful design of the MLX90640Bxx, it is recommended not to subject the MLX90640Bxx to heat transfer and especially transient conditions.

The MLX90640Bxx is designed and calibrated to operate as a non-contact thermometer in **settled conditions**. Using the thermometer in a very different way will result in unknown results.

Capacitive loading on an I²C can degrade the communication. Some improvement is possible with use of current sources compared to resistors in pull-up circuitry. Further improvement is possible with specialized commercially available bus accelerators. With the MLX90640Bxx additional improvement is possible by increasing the pull-up current (decreasing the pull-up resistor values). Input levels for I²C compatible mode have higher overall tolerance than the I²C specification, but the output low level is rather low even with the high-power I²C specification for pull-up currents. Another option might be to go for a slower communication (clock speed), as the MLX90640Bxx implements Schmidt triggers on its inputs in I²C compatible mode and is therefore not really sensitive to rise time of the bus (it is more likely the rise time to be an issue than the fall time, as far as the I²C systems are open drain with pull-up).

Power dissipation within the package may affect performance in two ways: by heating the “ambient” sensitive element significantly beyond the actual ambient temperature, as well as by causing gradients over the package that will inherently cause thermal gradient over the cap

Power supply decoupling capacitor is needed as with most integrated circuits. MLX90640Bxx is a mixed-signal device with sensors, small signal analog part, digital part and I/O circuitry. In order to keep the noise low power supply switching noise needs to be decoupled. High noise from external circuitry can also affect noise performance of the device. In many applications a 100nF SMD plus 10μF ceramic capacitors close to the Vdd and Vss pins would be a good choice. It should be noted that not only the trace to the Vdd pin needs to be short, but also the one to the Vss pin. Using MLX90640Bxx with short pins improves the effect of the power supply decoupling.

Check www.melexis.com for most recent application notes about MLX90640Bxx.

15. Mechanical drawings

15.1. FOV 55°

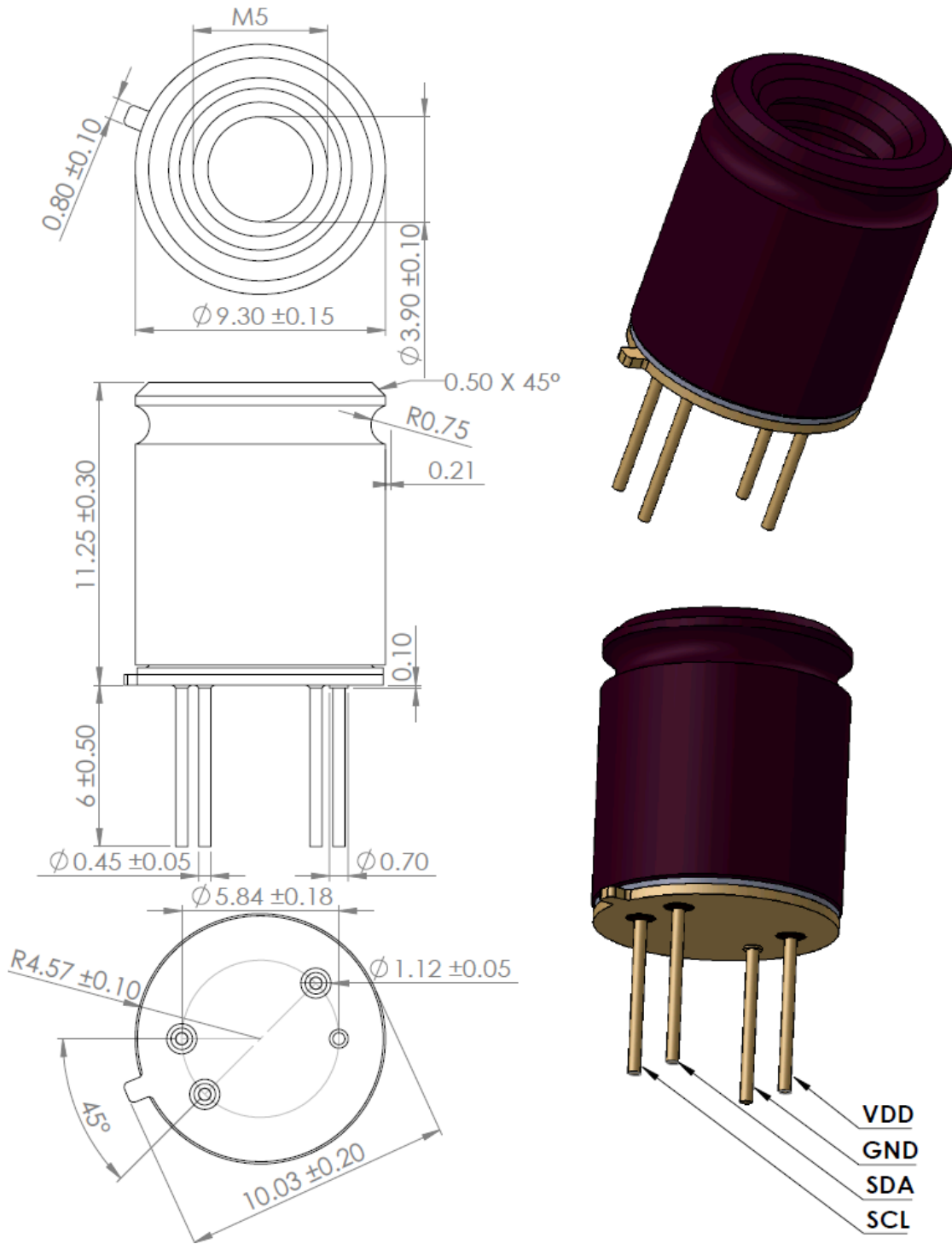

Figure 28 Mechanical drawing of 55° FOV device

15.2. FOV 110°

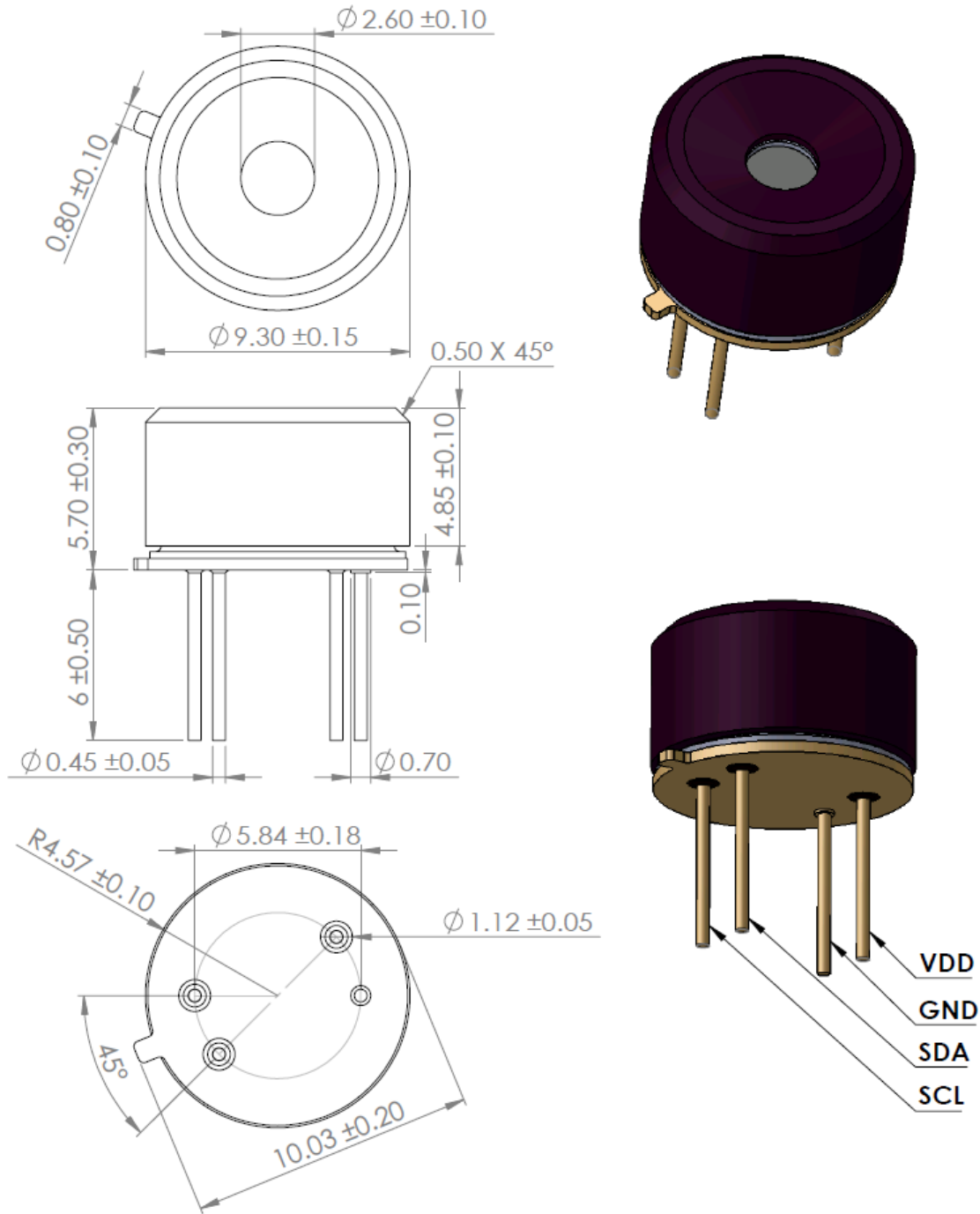

Figure 29 Mechanical drawing of 110° FOV device

15.3. Device marking

The MLX90640 is laser marked with 10 symbols as follows.

0	A	A	xxxxx	xx	Laser marking
					2 digits Split number
					5 digits LOT number
		A			FOV = 110°
		B			FOV = 55°
	A				Device without thermal gradient compensation (TGC = 0 and may not be changed)
	C				Device with thermal gradient compensation (TGC = -4...+3.98)
0	MLX90640				

- Example: “OCA1010218” – Device type MLX90640BAA from lot 10102, sub LOT split 18 and Thermal Gradient Compensation activated.

16. Standard Information

Our products are classified and qualified regarding soldering technology, solderability and moisture sensitivity level according to standards in place in Semiconductor industry.

For further details about test method references and for compliance verification of selected soldering method for product integration, Melexis recommends reviewing on our web site the General Guidelines [soldering recommendation](#). For all soldering technologies deviating from the one mentioned in above document (regarding peak temperature, temperature gradient, temperature profile etc.), additional classification and qualification tests have to be agreed upon with Melexis.

For package technology embedding trim and form post-delivery capability, Melexis recommends consulting the dedicated trim & forming recommendation application note: [lead trimming and forming recommendations](#)

Melexis is contributing to global environmental conservation by promoting **lead free** solutions. For more information on qualifications of **RoHS** compliant products (RoHS = European directive on the Restriction Of the use of certain Hazardous Substances) please visit the quality page on our website: <http://www.melexis.com/en/quality-environment>

17. ESD Precautions

Electronic semiconductor products are sensitive to Electro Static Discharge (ESD).

Always observe Electro Static Discharge control procedures whenever handling semiconductor products.

18. Revision history table

25/07/2016	Initial release
15/12/2016	Calibration data stored into EEPROM, pixel reading modes explained
17/01/2017	Some errors fixed
07/02/2017	Some calculations errors fixed
24/02/2017	Noise, FOV and accuracy graphs added, some inaccuracies fixed
02/03/2017	Overall rearranged , some typo and grammar mistakes fixed
18/05/2017	Two's complement for IR data from RAM and CP, added outlier identification in EEPROM , added application information
07/07/2017	Slave address changed to 0x240F, default mode is chess, CP RAM address changed 0x0709 -> 0x0708 and 0x0729 -> 0x0728, resolution control included in calculations, PCB under TO can removed
30/08/2017	Laser marking added, Max number of fail pixels added, Measurement flow (continuous and step mode) added, FOV definitions updated
10/10/2017	Added a note regarding CP averaging. Add dimension tolerances in mechanical drawings. Spelling errors corrected

11/04/2018	Updated accuracy table including BAB version, CP for different subpages, compensation for different reading patterns, extended temperature ranges calculations.
03/08/2018	Added: github driver link, ESD changed from 2kV to 4kV, Step mode removed, Internal register tables updated
03/12/2019	Rev 12: Max storage temp changed: 125°C to 85°C, added long term accuracy note, Ta accuracy added, added optical considerations, electrical consideration diagram updated with 10µF, added chamfer info, Doc server № added in the footer

19. Contact

For the latest version of this document, go to our website at www.melexis.com.

For additional information, please contact our Direct Sales team and get help for your specific needs:

Europe, Africa	Telephone: +32 13 67 04 95
	Email : sales_europe@melexis.com
Americas	Telephone: +1 603 223 2362
	Email : sales_usa@melexis.com
Asia	Email : sales_asia@melexis.com

20. Disclaimer

The information furnished by Melexis herein ("Information") is believed to be correct and accurate. Melexis disclaims (i) any and all liability in connection with or arising out of the furnishing, performance or use of the technical data or use of the product(s) as described herein ("Product") (ii) any and all liability, including without limitation, special, consequential or incidental damages, and (iii) any and all warranties, express, statutory, implied, or by description, including warranties of fitness for particular purpose, non-infringement and merchantability. No obligation or liability shall arise or flow out of Melexis' rendering of technical or other services.

The Information is provided "as is" and Melexis reserves the right to change the Information at any time and without notice. Therefore, before placing orders and/or prior to designing the Product into a system, users or any third party should obtain the latest version of the relevant information to verify that the information being relied upon is current. Users or any third party must further determine the suitability of the Product for its application, including the level of reliability required and determine whether it is fit for a particular purpose.

The Information is proprietary and/or confidential information of Melexis and the use thereof or anything described by the Information does not grant, explicitly or implicitly, to any party any patent rights, licenses, or any other intellectual property rights.

This document as well as the Product(s) may be subject to export control regulations. Please be aware that export might require a prior authorization from competent authorities.

The Product(s) are intended for use in normal commercial applications. Unless otherwise agreed upon in writing, the Product(s) are not designed, authorized or warranted to be suitable in applications requiring extended temperature range and/or unusual environmental requirements. High reliability applications, such as medical life-support or life-sustaining equipment are specifically not recommended by Melexis.

The Product(s) may not be used for the following applications subject to export control regulations: the development, production, processing, operation, maintenance, storage, recognition or proliferation of 1) chemical, biological or nuclear weapons, or for the development, production, maintenance or storage of missiles for such weapons; 2) civil firearms, including spare parts or ammunition for such arms; 3) defence related products, or other material for military use or for law enforcement; 4) any applications that, alone or in combination with other goods, substances or organisms could cause serious harm to persons or goods and that can be used as a means of violence in an armed conflict or any similar violent situation.

The Products sold by Melexis are subject to the terms and conditions as specified in the Terms of Sale, which can be found at <https://www.melexis.com/en/legal/terms-and-conditions>.

This document supersedes and replaces all prior information regarding the Product(s) and/or previous versions of this document.

Melexis NV © - No part of this document may be reproduced without the prior written consent of Melexis. (2016)

ISO/TS 16949 and ISO14001 Certified

Компания «Life Electronics» занимается поставками электронных компонентов импортного и отечественного производства от производителей и со складов крупных дистрибьюторов Европы, Америки и Азии.

С конца 2013 года компания активно расширяет линейку поставок компонентов по направлению коаксиальный кабель, кварцевые генераторы и конденсаторы (керамические, пленочные, электролитические), за счёт заключения дистрибьюторских договоров

Мы предлагаем:

- Конкурентоспособные цены и скидки постоянным клиентам.
- Специальные условия для постоянных клиентов.
- Подбор аналогов.
- Поставку компонентов в любых объемах, удовлетворяющих вашим потребностям.
- Приемлемые сроки поставки, возможна ускоренная поставка.
- Доставку товара в любую точку России и стран СНГ.
- Комплексную поставку.
- Работу по проектам и поставку образцов.
- Формирование склада под заказчика.
- Сертификаты соответствия на поставляемую продукцию (по желанию клиента).
- Тестирование поставляемой продукции.
- Поставку компонентов, требующих военную и космическую приемку.
- Входной контроль качества.
- Наличие сертификата ISO.

В составе нашей компании организован Конструкторский отдел, призванный помогать разработчикам, и инженерам.

Конструкторский отдел помогает осуществить:

- Регистрацию проекта у производителя компонентов.
- Техническую поддержку проекта.
- Защиту от снятия компонента с производства.
- Оценку стоимости проекта по компонентам.
- Изготовление тестовой платы монтаж и пусконаладочные работы.



Тел: +7 (812) 336 43 04 (многоканальный)

Email: org@lifeelectronics.ru