

Optocoupler, Phototransistor Output, Dual Channel

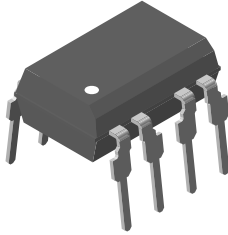

I179016

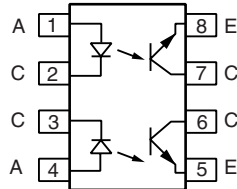

DESCRIPTION

The ILCT6/MCT6 is a two channel optocoupler for high density applications. Each channel consists of an optically coupled pair with a gallium arsenide infrared LED and a silicon NPN phototransistor. Signal information, including a DC level, can be transmitted by the device while maintaining a high degree of electrical isolation between input and output.

The ILCT6/MCT6 is especially designed for driving medium-speed logic, where it may be used to eliminate troublesome ground loop and noise problems. It can also be used to replace relays and transformers in many digital interface applications, as well as analog applications such as CRT modulation.

FEATURES

- Current transfer ratio, 50 % typical
- Leakage current, 1.0 nA typical
- Two isolated channels per package
- Lead (Pb)-free component
- Component in accordance to RoHS 2002/95/EC and WEEE 2002/96/EC

**RoHS
COMPLIANT**

AGENCY APPROVALS

- UL1577, file no. E52744 system code H or J, double protection
- DIN EN 60747-5-2 (VDE 0884)/DIN EN 60747-5-5 pending available with option 1
- CSA 93751
- BSI IEC 60950; IEC 60065

ORDER INFORMATION

PART	REMARKS
ILCT6	CTR \geq 20 %, DIP-8
MCT6	CTR \geq 20 %, DIP-8
ILCT6-X007	CTR \geq 20 %, SMD-8 (option 7)
ILCT6-X009	CTR \geq 20 %, SMD-8 (option 9)
MCT6-X007	CTR \geq 20 %, SMD-8 (option 7)
MCT6-X009	CTR \geq 20 %, SMD-8 (option 9)

Note

For additional information on the available options refer to option information.

ABSOLUTE MAXIMUM RATINGS				
PARAMETER	TEST CONDITION	SYMBOL	VALUE	UNIT
INPUT				
Rated forward current, DC			60	mA
Peak forward current, DC	1.0 μ s pulse, 300 pps	I_{FM}	3.0	A
Power dissipation		P_{diss}	100	mW
Derate linearly from 25 °C			1.3	mW/°C
OUTPUT				
Collector current		I_C	30	mA
Collector emitter breakdown voltage		BV_{CEO}	30	V
Power dissipation		P_{diss}	150	mW
Derate linearly from 25 °C			2.0	mW/°C
COUPLER				
Isolation test voltage		V_{ISO}	5300	V_{RMS}
Isolation resistance	$V_{IO} = 500$ V, $T_{amb} = 25$ °C	R_{IO}	$\geq 10^{12}$	Ω
	$V_{IO} = 500$ V, $T_{amb} = 100$ °C	R_{IO}	$\geq 10^{11}$	Ω
Creepage distance			≥ 7.0	mm
Clearance distance			≥ 7.0	mm
Total package dissipation		P_{tot}	400	mW
Derate linearly from 25 °C			5.33	mW/°C
Storage temperature		T_{stg}	- 55 to + 150	°C
Operating temperature		T_{amb}	- 55 to + 100	°C
Lead soldering time at 260 °C			10	s

Note

$T_{amb} = 25$ °C, unless otherwise specified.

Stresses in excess of the absolute maximum ratings can cause permanent damage to the device. Functional operation of the device is not implied at these or any other conditions in excess of those given in the operational sections of this document. Exposure to absolute maximum ratings for extended periods of the time can adversely affect reliability.

ELECTRICAL CHARACTERISTICS						
PARAMETER	TEST CONDITION	SYMBOL	MIN.	TYP.	MAX.	UNIT
INPUT						
Forward voltage	$I_F = 20$ mA	V_F		1.25	1.50	V
Reverse current	$V_R = 3.0$ V	I_R		0.1	10	μ A
Junction capacitance	$V_F = 0$ V	C_j		25		pF
OUTPUT						
Collector emitter breakdown voltage	$I_C = 1.0$ μ A, $I_E = 10$ μ A	BV_{CEO}	30	65		V
Emitter collector breakdown voltage	$I_C = 10$ μ A, $I_E = 10$ μ A	BV_{ECO}	7.0	10		V
Collector emitter leakage current	$V_{CE} = 10$ V	I_{CEO}		1.0	100	nA
Collector emitter capacitance	$V_{CE} = 0$ V	C_{CE}		8.0		pF
COUPLER						
Saturation voltage, collector emitter	$I_C = 2.0$ mA, $I_F = 16$ mA	V_{CEsat}			0.40	V
Capacitance (input to output)	$f = 1.0$ MHz	C_{IO}		0.5		pF
Capacitance between channels	$f = 1.0$ MHz			0.4		pF
Bandwidth	$I_C = 2.0$ mA, $V_{CC} = 10$ V, $R_L = 100$ Ω			150		kHz

Note

$T_{amb} = 25$ °C, unless otherwise specified.

Minimum and maximum values are testing requirements. Typical values are characteristics of the device and are the result of engineering evaluation. Typical values are for information only and are not part of the testing requirements.



CURRENT TRANSFER RATIO						
PARAMETER	TEST CONDITION	SYMBOL	MIN.	TYP.	MAX.	UNIT
DC current transfer ratio	$I_F = 10 \text{ mA}$, $V_{CE} = 10 \text{ V}$	CTR_{DC}	20	50		%

SWITCHING CHARACTERISTICS						
PARAMETER	TEST CONDITION	SYMBOL	MIN.	TYP.	MAX.	UNIT
Switching times, output transistor	$I_C = 2.0 \text{ mA}$, $R_E = 100 \Omega$, $V_{CE} = 10 \text{ V}$	t_{on} , t_{off}		3.0		μs

TYPICAL CHARACTERISTICS

$T_{amb} = 25 \text{ }^\circ\text{C}$, unless otherwise specified

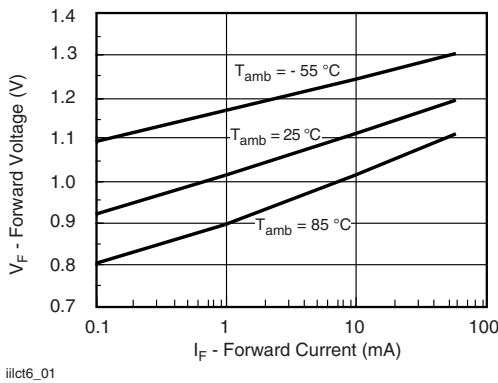

Fig. 1 - Forward Voltage vs. Forward Current

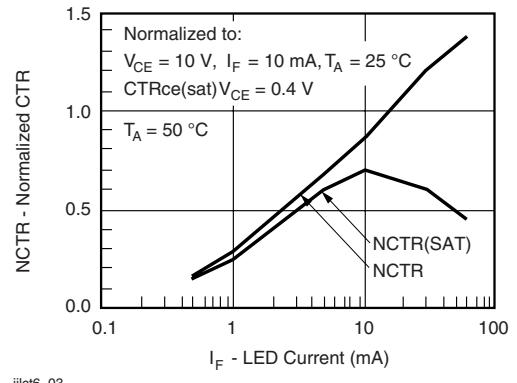

Fig. 3 - Normalized Non-Saturated and Saturated CTR vs. LED Current

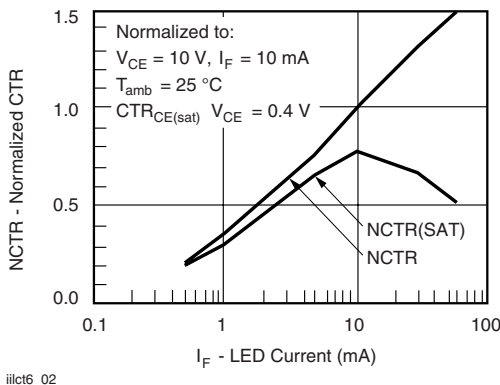

Fig. 2 - Normalized Non-Saturated and Saturated CTR vs. LED Current

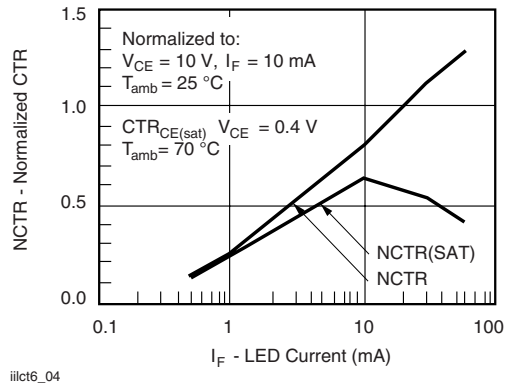
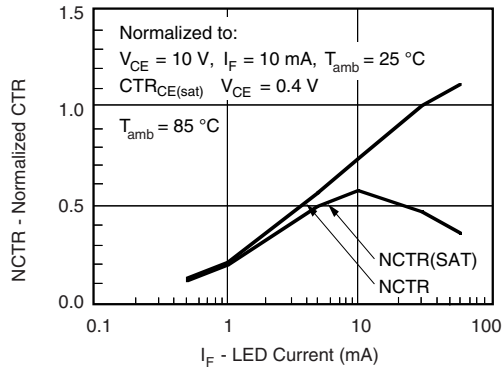
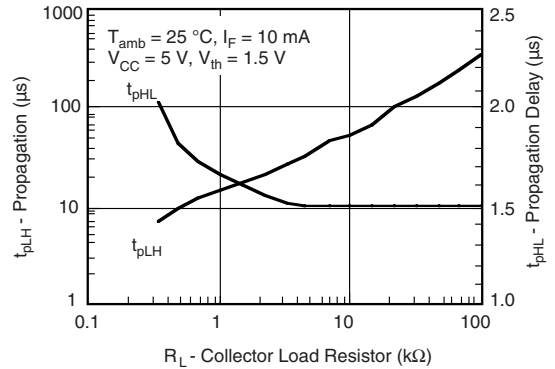

Fig. 4 - Normalized Non-Saturated and Saturated CTR vs. LED Current



iiilct6_05

Fig. 5 - Normalized Non-Saturated and Saturated CTR vs. LED Current



iiilct6_08

Fig. 8 - Propagation Delay vs. Collector Load Resistor

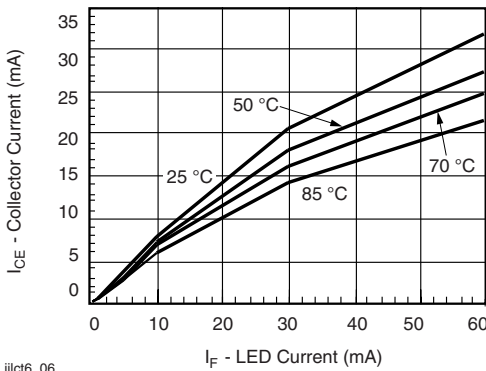

iiilct6_06

Fig. 6 - Collector Emitter Current vs. Temperature and LED Current

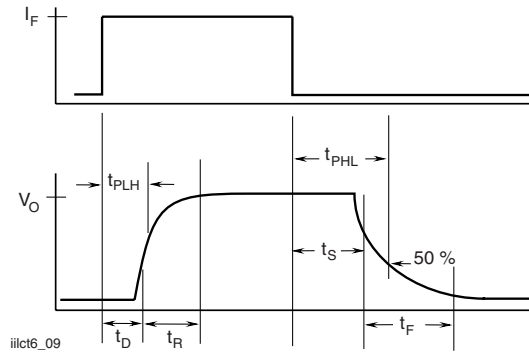

iiilct6_09

Fig. 9 - Switching Timing

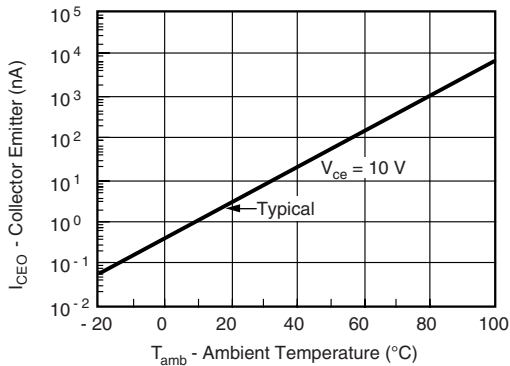

iiilct6_07

Fig. 7 - Collector Emitter Leakage Current vs. Temperature

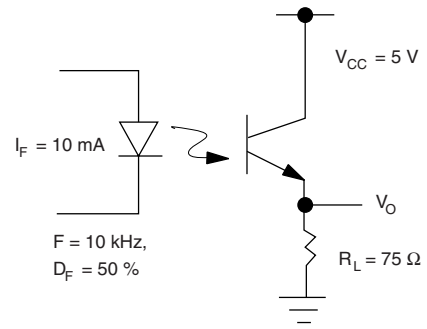

iiilct6_10

Fig. 10 - Switching Schematic



PACKAGE DIMENSIONS in inches (millimeters)

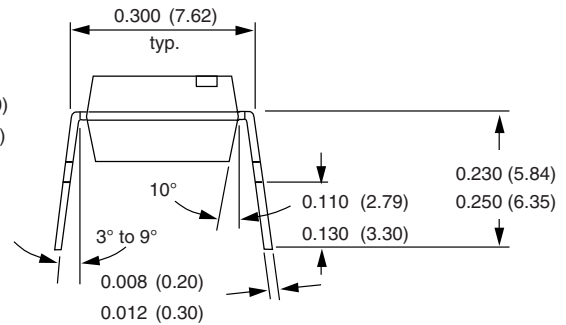
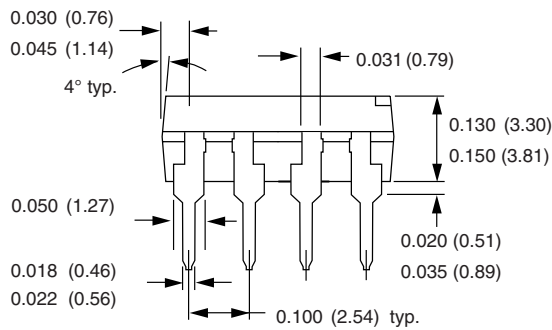
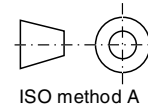
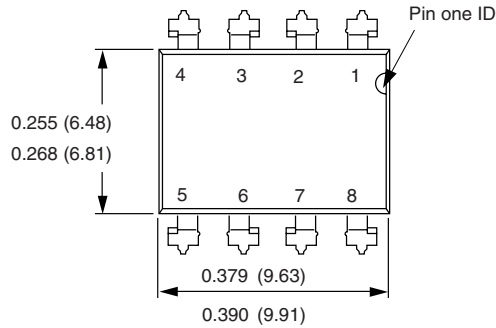

i178006

Option 7

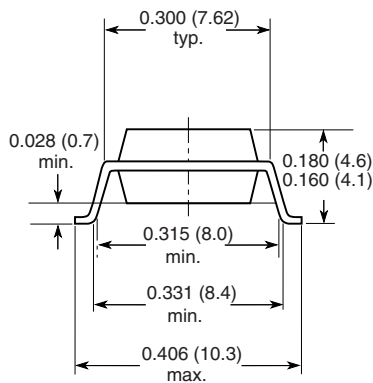

Option 9

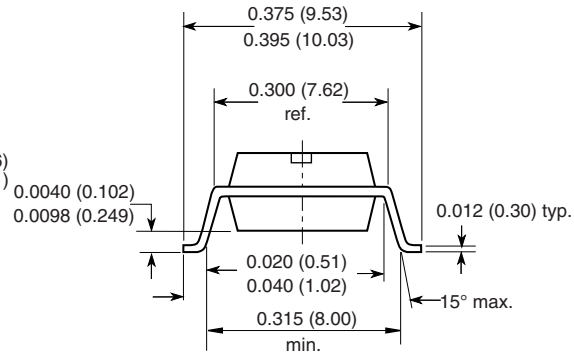

18494



OZONE DEPLETING SUBSTANCES POLICY STATEMENT

It is the policy of Vishay Semiconductor GmbH to

1. Meet all present and future national and international statutory requirements.
2. Regularly and continuously improve the performance of our products, processes, distribution and operating systems with respect to their impact on the health and safety of our employees and the public, as well as their impact on the environment.

It is particular concern to control or eliminate releases of those substances into the atmosphere which are known as ozone depleting substances (ODSs).

The Montreal Protocol (1987) and its London Amendments (1990) intend to severely restrict the use of ODSs and forbid their use within the next ten years. Various national and international initiatives are pressing for an earlier ban on these substances.

Vishay Semiconductor GmbH has been able to use its policy of continuous improvements to eliminate the use of ODSs listed in the following documents.

1. Annex A, B and list of transitional substances of the Montreal Protocol and the London Amendments respectively.
2. Class I and II ozone depleting substances in the Clean Air Act Amendments of 1990 by the Environmental Protection Agency (EPA) in the USA.
3. Council Decision 88/540/EEC and 91/690/EEC Annex A, B and C (transitional substances) respectively.

Vishay Semiconductor GmbH can certify that our semiconductors are not manufactured with ozone depleting substances and do not contain such substances.

We reserve the right to make changes to improve technical design
and may do so without further notice.

Parameters can vary in different applications. All operating parameters must be validated for each customer application by the customer. Should the buyer use Vishay Semiconductors products for any unintended or unauthorized application, the buyer shall indemnify Vishay Semiconductors against all claims, costs, damages, and expenses, arising out of, directly or indirectly, any claim of personal damage, injury or death associated with such unintended or unauthorized use.

Vishay Semiconductor GmbH, P.O.B. 3535, D-74025 Heilbronn, Germany



Disclaimer

All product specifications and data are subject to change without notice.

Vishay Intertechnology, Inc., its affiliates, agents, and employees, and all persons acting on its or their behalf (collectively, "Vishay"), disclaim any and all liability for any errors, inaccuracies or incompleteness contained herein or in any other disclosure relating to any product.

Vishay disclaims any and all liability arising out of the use or application of any product described herein or of any information provided herein to the maximum extent permitted by law. The product specifications do not expand or otherwise modify Vishay's terms and conditions of purchase, including but not limited to the warranty expressed therein, which apply to these products.

No license, express or implied, by estoppel or otherwise, to any intellectual property rights is granted by this document or by any conduct of Vishay.

The products shown herein are not designed for use in medical, life-saving, or life-sustaining applications unless otherwise expressly indicated. Customers using or selling Vishay products not expressly indicated for use in such applications do so entirely at their own risk and agree to fully indemnify Vishay for any damages arising or resulting from such use or sale. Please contact authorized Vishay personnel to obtain written terms and conditions regarding products designed for such applications.

Product names and markings noted herein may be trademarks of their respective owners.

Компания «Life Electronics» занимается поставками электронных компонентов импортного и отечественного производства от производителей и со складов крупных дистрибьюторов Европы, Америки и Азии.

С конца 2013 года компания активно расширяет линейку поставок компонентов по направлению коаксиальный кабель, кварцевые генераторы и конденсаторы (керамические, пленочные, электролитические), за счёт заключения дистрибьюторских договоров

Мы предлагаем:

- Конкурентоспособные цены и скидки постоянным клиентам.
- Специальные условия для постоянных клиентов.
- Подбор аналогов.
- Поставку компонентов в любых объемах, удовлетворяющих вашим потребностям.
- Приемлемые сроки поставки, возможна ускоренная поставка.
- Доставку товара в любую точку России и стран СНГ.
- Комплексную поставку.
- Работу по проектам и поставку образцов.
- Формирование склада под заказчика.
- Сертификаты соответствия на поставляемую продукцию (по желанию клиента).
- Тестирование поставляемой продукции.
- Поставку компонентов, требующих военную и космическую приемку.
- Входной контроль качества.
- Наличие сертификата ISO.

В составе нашей компании организован Конструкторский отдел, призванный помогать разработчикам, и инженерам.

Конструкторский отдел помогает осуществить:

- Регистрацию проекта у производителя компонентов.
- Техническую поддержку проекта.
- Защиту от снятия компонента с производства.
- Оценку стоимости проекта по компонентам.
- Изготовление тестовой платы монтаж и пусконаладочные работы.



Тел: +7 (812) 336 43 04 (многоканальный)

Email: org@lifeelectronics.ru