

Chip beads

For general signal line

Soft termination

KMZ-HR series (for automotive)



AEC-Q200

KMZ1608-HR type



FEATURES

- Noise reduction solution for general signal line.
- Various frequency characteristics with 6 materials of different features for countermeasures against everything from general signals to high-speed signals.
- Guide electric property resin absorbs external stress, and mechanical stress, resistance force to thermal shock is improved.
- Easing by conductive resin thermal stress, and respond for High-temperature environment of 150°C, too.
- Operating temperature range: -55 to +150°C
- Compliant with AEC-Q200

APPLICATION

- Various ECUs, powertrains, body controls, and car multimedia (telematics).

PART NUMBER CONSTRUCTION

| | | | | | | | |
|-------------|--|---------------|------------------------|-------------------------|---------------------|-----------------|---------------|
| KMZ | 1608 | B | HR | 601 | C | T | DH5 |
| Series name | LxWxT dimensions 1.6x0.8x0.6 mm 1.6x0.8x0.8 mm | Material name | Specifications (Grade) | Impedance (Ω) at 100MHz | Characteristic type | Packaging style | Internal code |



KMZ1608-HR type

CHARACTERISTICS SPECIFICATION TABLE

| Impedance [100MHz] (Ω) | | DC resistance (Ω)max. | Rated current (mA)max. | Thickness T (mm) | Part No. |
|---------------------------------------|------------|-----------------------------------|---------------------------|---------------------|------------------------------------|
| | Tolerance | | | | |
| 600 | $\pm 25\%$ | 0.4 | 500 | 0.6 | KMZ1608BHR601CTDH5 |
| 1000 | $\pm 25\%$ | 0.6 | 300 | 0.8 | KMZ1608BHR102CTD25 |
| 60 | $\pm 25\%$ | 0.1 | 800 | 0.8 | KMZ1608RHR600ATD25 |
| 120 | $\pm 25\%$ | 0.18 | 500 | 0.8 | KMZ1608RHR121ATD25 |
| 600 | $\pm 25\%$ | 0.4 | 500 | 0.8 | KMZ1608RHR601ATD25 |
| 1000 | $\pm 25\%$ | 0.5 | 400 | 0.8 | KMZ1608RHR102ATD25 |
| 120 | $\pm 25\%$ | 0.15 | 500 | 0.8 | KMZ1608SHR121ATD25 |
| 600 | $\pm 25\%$ | 0.35 | 500 | 0.8 | KMZ1608SHR601ATD25 |
| 1000 | $\pm 25\%$ | 0.5 | 400 | 0.8 | KMZ1608SHR102ATD25 |
| 60 | $\pm 25\%$ | 0.15 | 500 | 0.8 | KMZ1608YHR600BTD25 |
| 120 | $\pm 25\%$ | 0.2 | 500 | 0.8 | KMZ1608YHR121BTD25 |
| 300 | $\pm 25\%$ | 0.3 | 500 | 0.8 | KMZ1608YHR301BTD25 |
| 600 | $\pm 25\%$ | 0.4 | 500 | 0.8 | KMZ1608YHR601BTD25 |
| 1000 | $\pm 25\%$ | 0.5 | 400 | 0.8 | KMZ1608YHR102BTD25 |
| 1500 | $\pm 25\%$ | 0.6 | 300 | 0.8 | KMZ1608YHR152BTD25 |
| 2500 | $\pm 25\%$ | 0.8 | 200 | 0.8 | KMZ1608AHR252BTD25 |
| 50 | $\pm 25\%$ | 0.25 | 500 | 0.6 | KMZ1608DHR500CTDH5 |
| 120 | $\pm 25\%$ | 0.3 | 400 | 0.6 | KMZ1608DHR121CTDH5 |
| 240 | $\pm 25\%$ | 0.6 | 300 | 0.8 | KMZ1608DHR241CTD25 |

* Please refer to the graph of rated current vs. temperature characteristics (derating) about the rating current at 125°C or more in temperature of the product.

Measurement equipment

| Measurement item | Product No. | Manufacturer |
|------------------|---------------|-----------------------|
| Impedance | E4991A+16192A | Keysight Technologies |
| DC resistance | Type-7556 | Yokogawa |

* Equivalent measurement equipment may be used.

Rated current vs. temperature characteristics (derating)



| | |
|--------------------|---------------------------------------|
| — RHR600A | — RHR121A, SHR121A, YHR600B, YHR121B, |
| — YHR301B, DHR500C | — BHR601C, RHR601A, SHR601A, YHR601B |
| — SHR102A | — RHR102A, YHR102B, DHR121C |
| — BHR102C, DHR241C | — YHR152B |
| | — AHR252B |

KMZ1608-HR type

Z VS. FREQUENCY CHARACTERISTICS (BY SERIES)

KMZ1608BHR series



KMZ1608RHR series



KMZ1608SHR series



KMZ1608YHR series

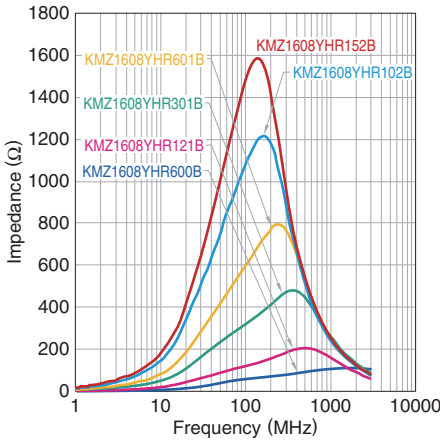

KMZ1608AHR series

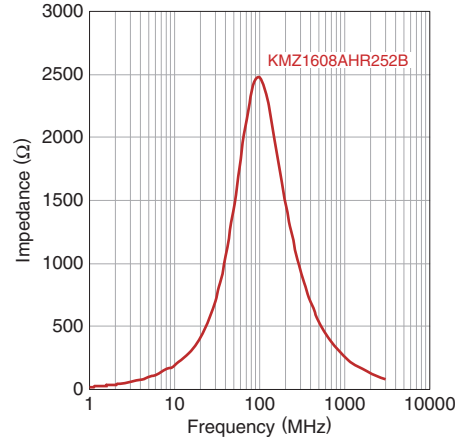

KMZ1608DHR series

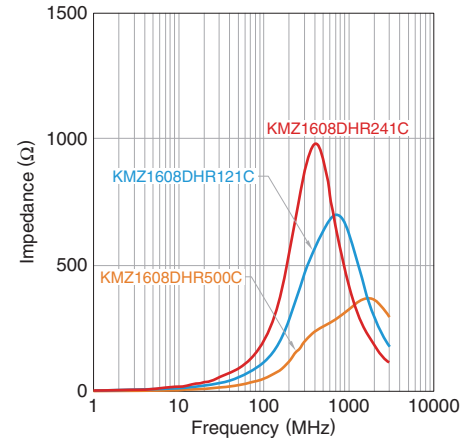

KMZ1608-HR type

Z, X, R VS. FREQUENCY CHARACTERISTICS

KMZ1608BHR601CTDH5



KMZ1608BHR102CTD25



KMZ1608RHR600ATD25



KMZ1608RHR121ATD25

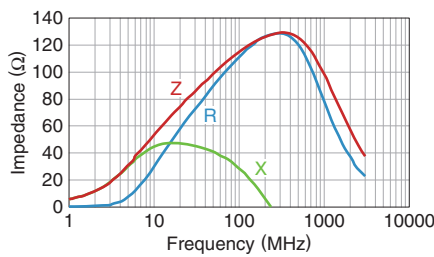

KMZ1608RHR601ATD25

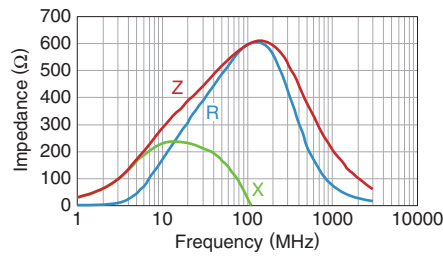

KMZ1608RHR102ATD25



KMZ1608SHR121ATD25

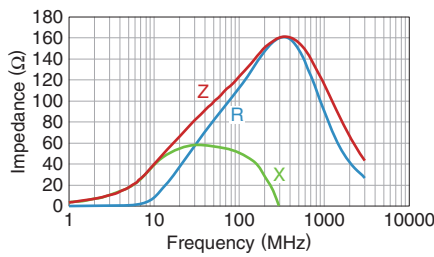

KMZ1608SHR601ATD25

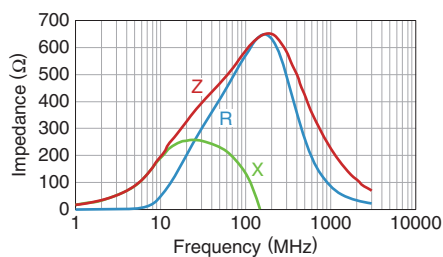

KMZ1608SHR102ATD25

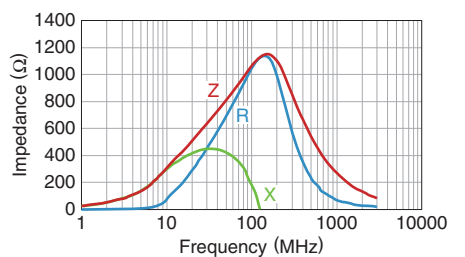

KMZ1608YHR600BTD25

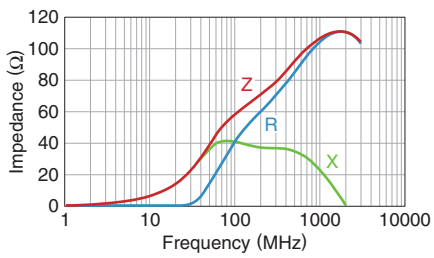

KMZ1608YHR121BTD25

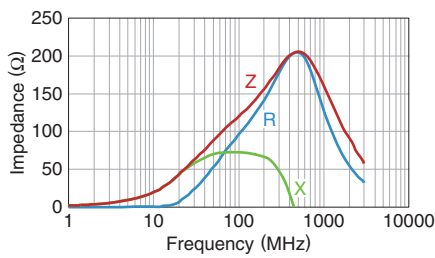

KMZ1608YHR301BTD25

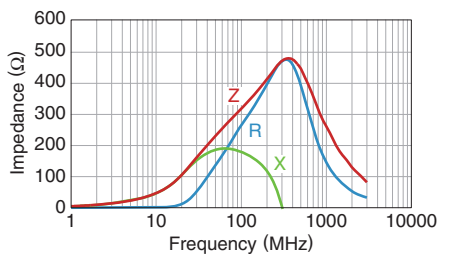

KMZ1608YHR601BTD25

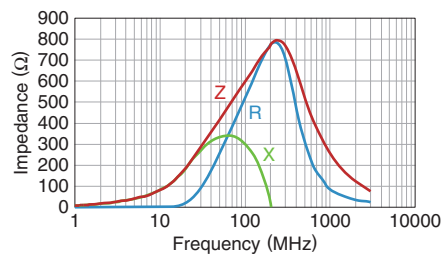

KMZ1608YHR102BTD25

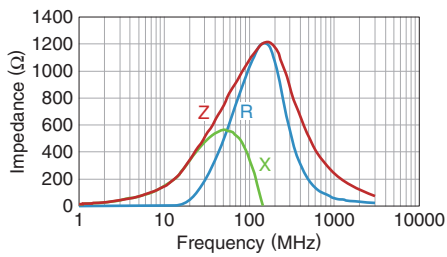

KMZ1608YHR152BTD25

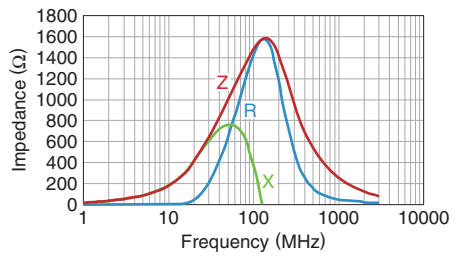

⚠ Please be sure to request delivery specifications that provide further details on the features and specifications of the products for proper and safe use. Please note that the contents may change without any prior notice due to reasons such as upgrading.

KMZ1608-HR type

Z, X, R VS. FREQUENCY CHARACTERISTICS

KMZ1608AHR252BTD25

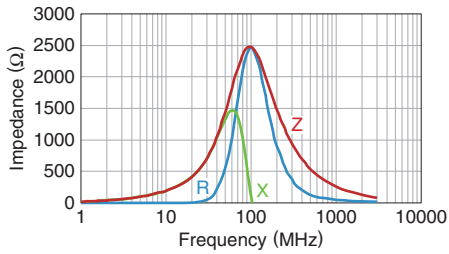

KMZ1608DHR500CTDH5

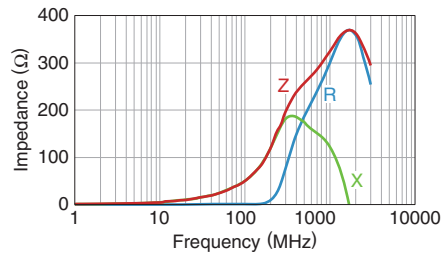

KMZ1608DHR121CTDH5

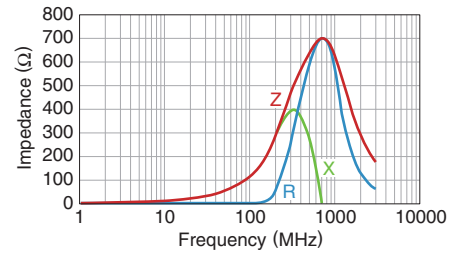

KMZ1608DHR241CTD25



KMZ1608-HR type

SHAPE & DIMENSIONS

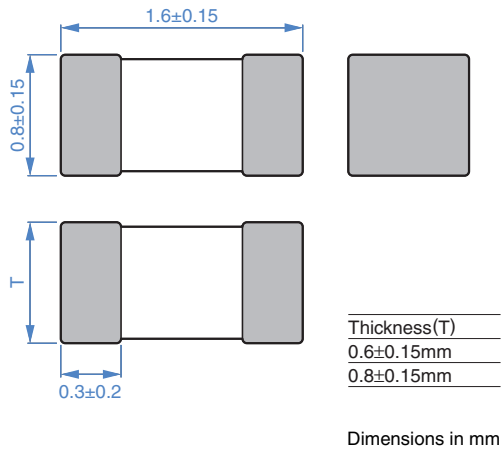

PACKAGING STYLE

REEL DIMENSIONS

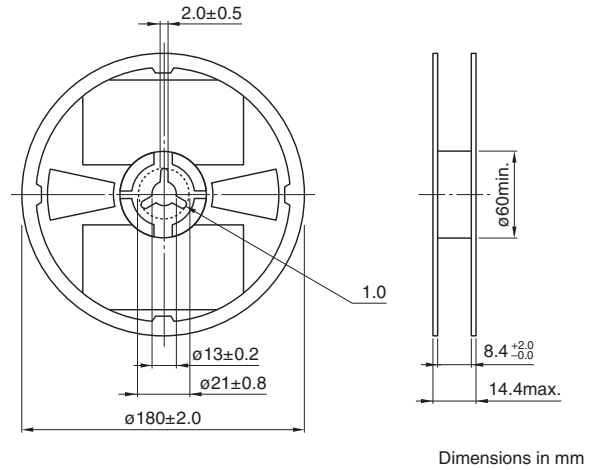

RECOMMENDED LAND PATTERN

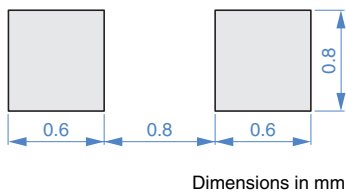

TAPE DIMENSIONS

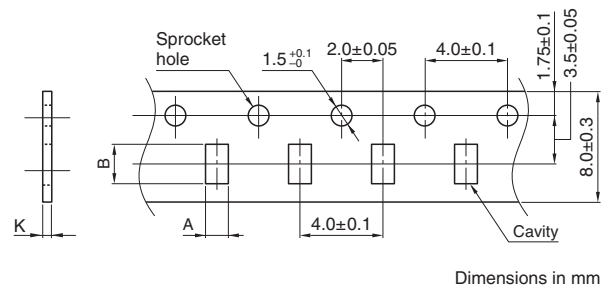

RECOMMENDED REFLOW PROFILE



| Type | A | B | K |
|------------|---------|---------|---------|
| KMZ1608-HR | 1.1±0.2 | 1.9±0.2 | 1.1max. |

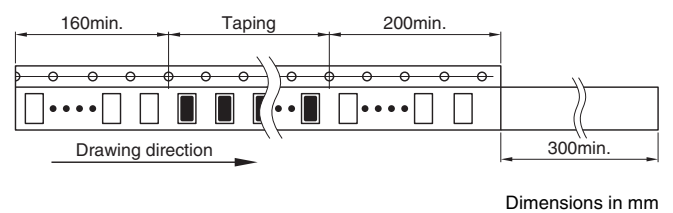

PACKAGE QUANTITY

| | |
|------------------|----------------|
| Package quantity | 4,000 pcs/reel |
|------------------|----------------|

TEMPERATURE RANGE, INDIVIDUAL WEIGHT

| Type | Operating temperature range | Storage temperature range* | Individual weight |
|---------------|-----------------------------|----------------------------|-------------------|
| t=0.6mm (DH5) | -55 to +150 °C | -55 to +150 °C | 3 mg |
| t=0.8mm (D25) | -55 to +150 °C | -55 to +150 °C | 4 mg |

* The storage temperature range is for after the assembly.

REMINDERS FOR USING THESE PRODUCTS

Before using these products, be sure to request the delivery specifications.

SAFETY REMINDERS

Please pay sufficient attention to the warnings for safe designing when using this products.

REMINDERS

- The storage period is within 12 months. Be sure to follow the storage conditions (temperature: 5 to 40°C, humidity: 10 to 75% RH or less).
If the storage period elapses, the soldering of the terminal electrodes may deteriorate.
- Do not use or store in locations where there are conditions such as gas corrosion (salt, acid, alkali, etc.).
- Before soldering, be sure to preheat components.
The preheating temperature should be set so that the temperature difference between the solder temperature and chip temperature does not exceed 150°C.
- Soldering corrections after mounting should be within the range of the conditions determined in the specifications.
If overheated, a short circuit, performance deterioration, or lifespan shortening may occur.
- When embedding a printed circuit board where a chip is mounted to a set, be sure that residual stress is not given to the chip due to the overall distortion of the printed circuit board and partial distortion such as at screw tightening portions.
- Self heating (temperature increase) occurs when the power is turned ON, so the tolerance should be sufficient for the set thermal design.
- Carefully lay out the coil for the circuit board design of the non-magnetic shield type.
A malfunction may occur due to magnetic interference.
- Use a wrist band to discharge static electricity in your body through the grounding wire.
- Do not expose the products to magnets or magnetic fields.
- Do not use for a purpose outside of the contents regulated in the delivery specifications.
- The products listed on this catalog are intended for use in general electronic equipment (AV equipment, telecommunications equipment, home appliances, amusement equipment, computer equipment, personal equipment, office equipment, measurement equipment, industrial robots) under a normal operation and use condition.
The products are not designed or warranted to meet the requirements of the applications listed below, whose performance and/or quality require a more stringent level of safety or reliability, or whose failure, malfunction or trouble could cause serious damage to society, person or property.
If you intend to use the products in the applications listed below or if you have special requirements exceeding the range or conditions set forth in the each catalog, please contact us.

- (1) Aerospace/aviation equipment
- (2) Transportation equipment (electric trains, ships, etc.)
- (3) Medical equipment
- (4) Power-generation control equipment
- (5) Atomic energy-related equipment
- (6) Seabed equipment
- (7) Transportation control equipment

- (8) Public information-processing equipment
- (9) Military equipment
- (10) Electric heating apparatus, burning equipment
- (11) Disaster prevention/crime prevention equipment
- (12) Safety equipment
- (13) Other applications that are not considered general-purpose applications

When designing your equipment even for general-purpose applications, you are kindly requested to take into consideration securing protection circuit/device or providing backup circuits in your equipment.

Компания «Life Electronics» занимается поставками электронных компонентов импортного и отечественного производства от производителей и со складов крупных дистрибьюторов Европы, Америки и Азии.

С конца 2013 года компания активно расширяет линейку поставок компонентов по направлению коаксиальный кабель, кварцевые генераторы и конденсаторы (керамические, пленочные, электролитические), за счёт заключения дистрибьюторских договоров

Мы предлагаем:

- Конкурентоспособные цены и скидки постоянным клиентам.
- Специальные условия для постоянных клиентов.
- Подбор аналогов.
- Поставку компонентов в любых объемах, удовлетворяющих вашим потребностям.
- Приемлемые сроки поставки, возможна ускоренная поставка.
- Доставку товара в любую точку России и стран СНГ.
- Комплексную поставку.
- Работу по проектам и поставку образцов.
- Формирование склада под заказчика.
- Сертификаты соответствия на поставляемую продукцию (по желанию клиента).
- Тестирование поставляемой продукции.
- Поставку компонентов, требующих военную и космическую приемку.
- Входной контроль качества.
- Наличие сертификата ISO.

В составе нашей компании организован Конструкторский отдел, призванный помогать разработчикам, и инженерам.

Конструкторский отдел помогает осуществить:

- Регистрацию проекта у производителя компонентов.
- Техническую поддержку проекта.
- Защиту от снятия компонента с производства.
- Оценку стоимости проекта по компонентам.
- Изготовление тестовой платы монтаж и пусконаладочные работы.

