

CUSTOMER DRAWING



**FREE CONNECTOR
(HELIOS H4 ASSEMBLED)**



**FIXED CONNECTOR
(HELIOS H4 BULKHEAD - M12)**



**FIXED CONNECTOR
(HELIOS H4 BULKHEAD - M14)**

3. SPECIFICATIONS:

CONTACT SIZE	1.5mm ² /16AWG	2.5mm ² /14AWG	4mm ² /12AWG	6mm ² /10AWG	10mm ² /8AWG
RATED CURRENT	35A (UL)				
	N/A	32A (TUV)	40A (TUV)	44A (TUV)	65A (TUV)
RATED SYSTEM VOLTAGE	600V/1000V DC(UL) 1000V DC(TUV)				
CONTACT RESISTANCE	0.25mΩ TYP.				
DEGREE OF PROTECTION, MATED	IP68(1m, 1h)				
PIN CONTACT MATERIAL	COPPER, TIN PLATED				
INSULATION MATERIAL	THERMOPLASTIC, UL94 V-0				
AMBIENT TEMPERATURE RANGE	-40°C TO +85°C				
STRIP LENGTH	7.0 mm				
CABLE JACKET DIAMETER	4.5 TO 7.8mm FOR TUV 1000V RATING 5.25 TO 7.7mm FOR UL 1000V RATING 5.25 TO 7.95mm FOR UL 600V RATING				

2. USE ONLY CRIMP TOOL AMPHENOL H4TC0002 TO CRIMP CONTACTS

1. THIS ASSEMBLY SHALL BE CERTIFIED RoHS COMPLIANT TO THE EUROPEAN UNION DIRECTIVE 2002/95/EC AS AMENDED PER 2005/618/EC.

NOTES:

THE USE OF THIS DOCUMENT IS UNLIMITED. HOWEVER, DOCUMENTS REFERENCED HEREON MAY CONTAIN LIMITED RIGHTS DATA.

PRO/ENGINEER INFORMATION	
N/A	Pro/e Model Used:
N/A	CPV-090508-M-ASSEM
	Drawing Name:
	PV-1005X-000-SF-CUS
	NEXT ASSEMBLY

UNLESS OTHERWISE SPECIFIED	SPECIFICATIONS	POS	QTY	PART NUMBER	DESCRIPTION	NOTE
LINEAR DIMENSIONS ARE IN: MILLIMETERS TOLERANCES: ANGLES = ±2° DIM. & TOL. PER ASME Y14.5M-1994; DRW PER MIL-DTL-31000; OTHER AMPHENOL STANDARDS: 9-9318 LEGENDS: = FLAG NOTE CALL OUT REFERENCE ONLY	MATERIAL SPEC.	PARTS LIST				
	N/A	AMPHENOL CORPORATION 40-60 DELAWARE AVENUE SIDNEY, N.Y. 13838 HELIOS H4 1000V/600V CONNECTOR ASSEMBLY				
PROCESS SPEC.	N/A	APPROVALS		DATE	SIZE C CAGE CODE 77820 DOCUMENT NO. H4C-() REV. E SCALE: 1.0 REF: - SHEET 1 OF 4	
		PREPARED BY	LEON LI	2012-05-23		
		ENGINEER IN CHARGE				
		DESIGN MANAGER				
		DESIGN ACTIVITY GROUP	R&D			
		THIRD ANGLE PROJECTION				

ORDER P/N: H4CFC2DMS

- (BLANK): COLD FORGING CONTACT
- S: STAMPING FORM CONTACT
- I: INDIVIDUAL PACKING WITH PE BAG (800PCS PER BOX)
- C: BULK PACK 100PCS WITH PE BAG (1000PCS PER BOX)
- M: BULK PACK 500PCS PER PE BAG (1000PCS PER BOX)
- D: TUV & UL APPROVAL
- 2: FOR 2.5mm²/14AWG CABLE (FOR C&F,
AND ALSO FOR 1.5 & 2.5mm²/16 & 14AWG S&F)
- 4: FOR 4.0mm²/12AWG CABLE (FOR C&F,
AND ALSO FOR 4.0 & 6.0mm²/12 & 10AWG S&F)
- 6: FOR 6.0mm²/10AWG CABLE (FOR C&F ONLY)
- 8: FOR 10.0mm²/8AWG CABLE (FOR C&F ONLY)
- C: CABLE GLAND (FREE CONN)
- M: BULKHEAD M12
- N: BULKHEAD M14
- F: FEMALE
- M: MALE

REVISIONS		
LTR	DESCRIPTION	DATE
A	INITIAL RELEASE	2011-04-18
B	MODIFY THE TOLERANCE	2011-12-05
C	ADD THE INTERFACE DIMENSION	2011-12-14
D	UPGRADE TO 1000V UL RATING	2012-03-20
E	UPDATE TUV MARK	2012-05-23

DOCUMENT NO. H4C-() SHEET 1 OF 4 REV. E

DOCUMENT NO. H4C-() SHEET 1 OF 4 REV. E

DOCUMENT NO. H4C-() SHEET 1 OF 4 REV. E

FREE CONNECTOR (HELIOS H4 ASSEMBLED)



FIXED CONNECTOR (HELIOS H4 BULKHEAD - M12)



FIXED CONNECTOR (HELIOS H4 BULKHEAD - M14)



- 5. THE MARK OF LETTERS JUST THE VERSION OF THE PLASTIC PARTS FOR AMPHENOL'S MANUFACTURE PROCEDURE, WHEN THE CUSTOMER INSPECT THE PRODUCT, THEY CAN IGNORE THESE NUMBERS.
- 4. FLAT GASKET AND NUT SHOULD NOT BE ASSEMBLED TO THE BODY. SOCKET AND PIN SHOWN INSTALLED FOR REFERENCE ONLY.

THE USE OF THIS DOCUMENT IS UNLIMITED. HOWEVER, DOCUMENTS REFERENCED HEREON MAY CONTAIN LIMITED RIGHTS DATA.

SIZE C	CAGE CODE 77820	DOCUMENT NO. H4C-()	REV. E
SCALE: 1.0	REF: -	SHEET 2 OF 4	

DOCUMENT NO. H4C-() REV. SHEET 2 OF 4 E

DOCUMENT NO. H4C-() REV. SHEET 2 OF 4 E

STAMPING & FORM CONTACT



SOCKET (FEMALE)



	A (mm)
1.5 & 2.5mm ²	4.8
4.0 & 6.0mm ²	5.8



PIN (MALE)



ORDER P/N FOR CONTACTS REEL & PACKING INFO

H4FF4R

- R: 2000PCS PER REEL
- 2: CABLE SIZE: 1.5 & 2.5mm²/16 & 14AWG
- 4: CABLE SIZE: 4.0 & 6.0mm²/12 & 10AWG
- F: FOR FEMALE
- M: FOR MALE
- F: STAMPING FORM CONTACTS

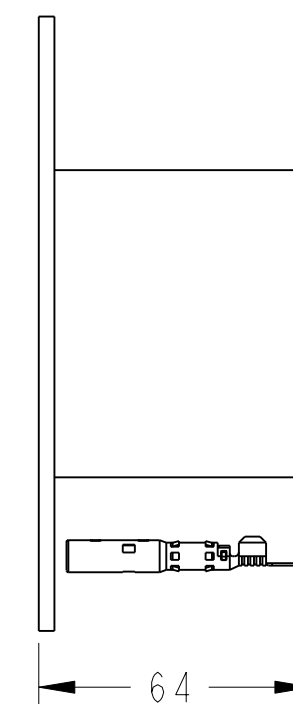
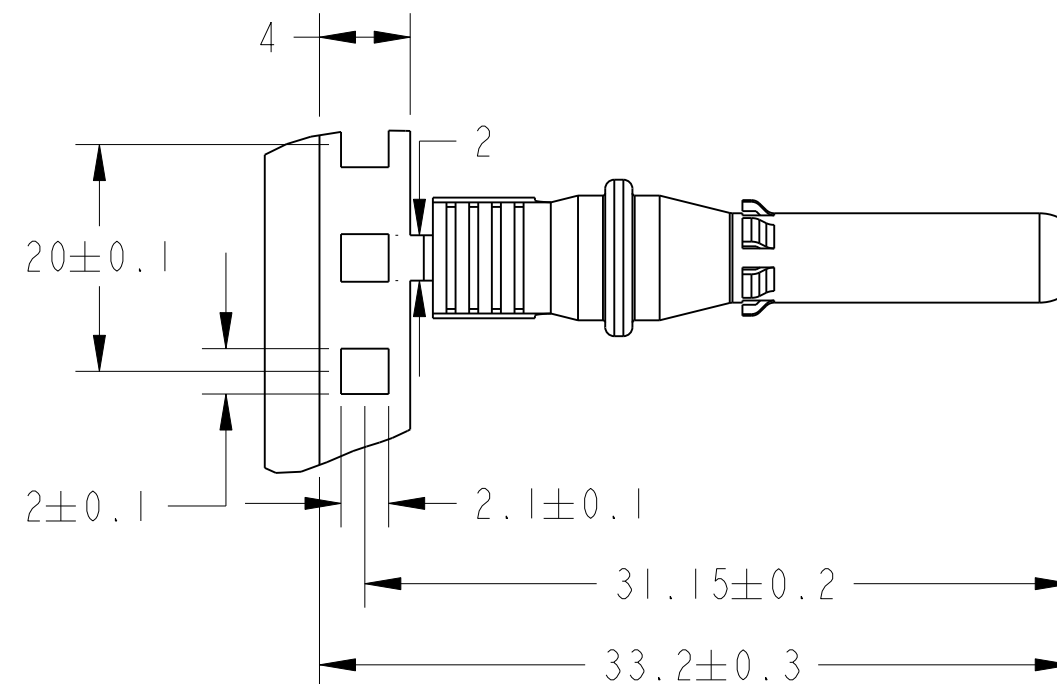
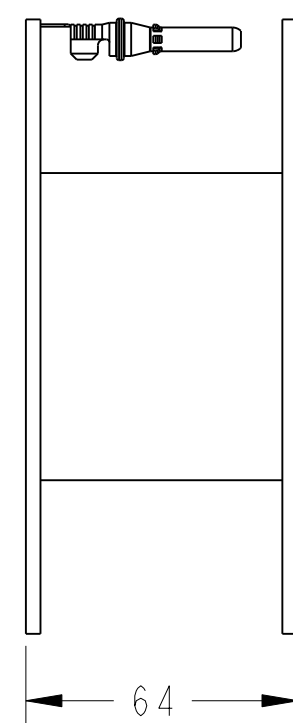

THE USE OF THIS DOCUMENT IS UNLIMITED. HOWEVER, DOCUMENTS REFERENCED HEREON MAY CONTAIN LIMITED RIGHTS DATA.

SIZE C	CAGE CODE 77820	DOCUMENT NO. H4C-()	REV. E
SCALE: 1.0	REF: -	SHEET 3 OF 4	

COLD FORGING CONTACT

DOCUMENT NO. H4C-()
SHEET 4 OF 4
REV. E

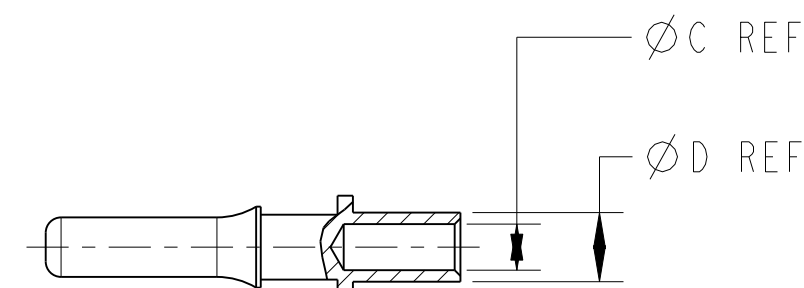
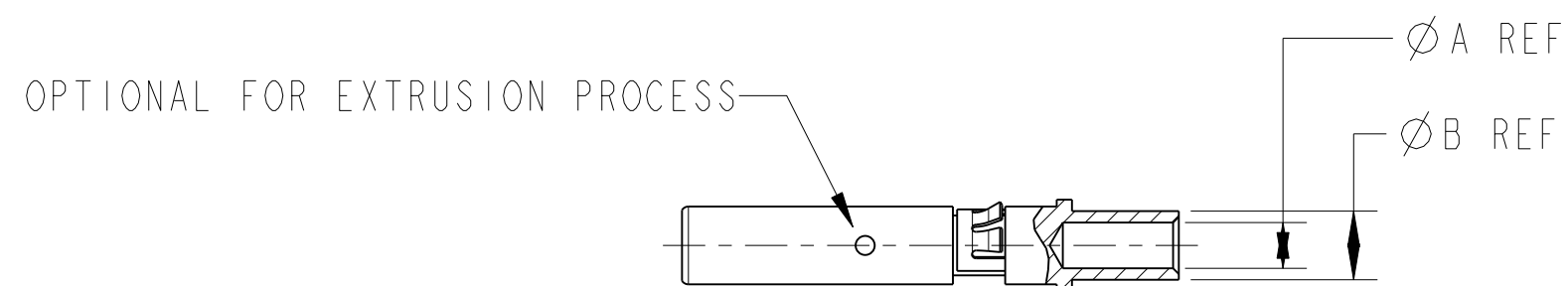
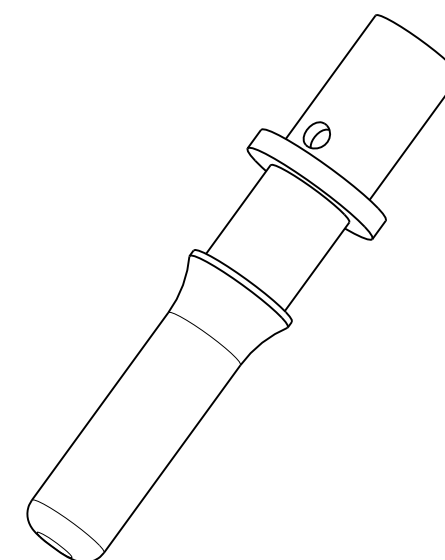
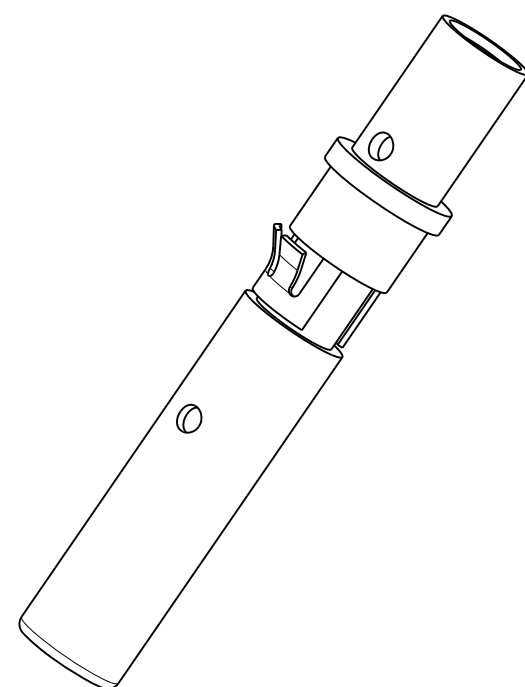

SOCKET (FEMALE)

PIN (MALE)

ACCEPT WIRE CONDUCTOR SIZE mm ² (AWG)	"A"	"B"
2.5 (14)	2.30	3.51
4.0 (12)	3.05	4.57
6.0 (10)	3.76	6.00
10.0(8)	4.50	6.00

ACCEPT WIRE CONDUCTOR SIZE mm ² (AWG)	"C"	"D"
2.5 (14)	2.30	3.51
4.0 (12)	3.05	4.57
6.0 (10)	3.76	6.00
10.0(8)	4.50	6.00

THE USE OF THIS DOCUMENT IS UNLIMITED.
HOWEVER, DOCUMENTS REFERENCED HEREON
MAY CONTAIN LIMITED RIGHTS DATA.

SIZE C	CAGE CODE 77820	DOCUMENT NO. H4C-()	REV. E
SCALE: 1.0	REF: -	SHEET 4 OF 4	

D
C
B
A
REV. E
SHEET 4 OF 4
DOCUMENT NO. H4C-()

Компания «Life Electronics» занимается поставками электронных компонентов импортного и отечественного производства от производителей и со складов крупных дистрибьюторов Европы, Америки и Азии.

С конца 2013 года компания активно расширяет линейку поставок компонентов по направлению коаксиальный кабель, кварцевые генераторы и конденсаторы (керамические, пленочные, электролитические), за счёт заключения дистрибьюторских договоров

Мы предлагаем:

- Конкурентоспособные цены и скидки постоянным клиентам.
- Специальные условия для постоянных клиентов.
- Подбор аналогов.
- Поставку компонентов в любых объемах, удовлетворяющих вашим потребностям.
- Приемлемые сроки поставки, возможна ускоренная поставка.
- Доставку товара в любую точку России и стран СНГ.
- Комплексную поставку.
- Работу по проектам и поставку образцов.
- Формирование склада под заказчика.
- Сертификаты соответствия на поставляемую продукцию (по желанию клиента).
- Тестирование поставляемой продукции.
- Поставку компонентов, требующих военную и космическую приемку.
- Входной контроль качества.
- Наличие сертификата ISO.

В составе нашей компании организован Конструкторский отдел, призванный помогать разработчикам, и инженерам.

Конструкторский отдел помогает осуществить:

- Регистрацию проекта у производителя компонентов.
- Техническую поддержку проекта.
- Защиту от снятия компонента с производства.
- Оценку стоимости проекта по компонентам.
- Изготовление тестовой платы монтаж и пусконаладочные работы.



Тел: +7 (812) 336 43 04 (многоканальный)
Email: org@lifeelectronics.ru