

### Product Overview

The AG203-63 is a general-purpose buffer amplifier that offers high dynamic range in a low-cost surface-mount package. At 900 MHz, the AD203-63 typically provides 20 dB gain, +20 dBm OPI3, and +8 dBm P1dB. The device combines dependable performance with consistent quality to maintain MTTF values exceeding 1000 years at mounting temperatures of +85 °C and is housed in a lead-free / green / RoHS-compliant SOT-363 industry standard SMT package.

The AG203-63 consists of a Darlington-pair amplifier using the high reliability InGap / GaAs HBT process technology and only requires DC-blocking capacitors, a bias resistor, and an inductive RF choke for operation.

The broadband AG203-63 MMIC amplifier can be directly applied to various current and next generation wireless technologies such as GPRS, GSM, CDMA, and WCDMA. In addition, the AG203-63 will work for other various applications from DC to 6 GHz frequency range such as CATV and WiMAX.



SOT-363 Package

### Key Features

- DC – 6000 MHz
- +20 dB Gain at 900 MHz
- +8 dBm Output P1dB at 900 MHz
- +20 dBm OIP3 at 900 MHz
- Single Voltage Supply
- Internally matched to 50 Ω
- Robust 1000 V ESD, Class 1C
- Lead-free / Green / RoHS – compliant SOT-363 package

### Functional Block Diagram

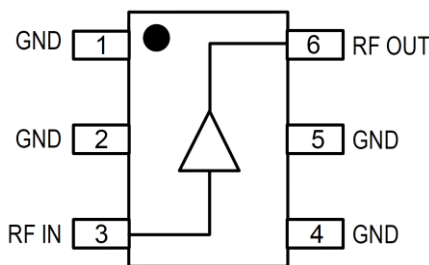

Top View

### Pin Configuration

Pin No.	Function
3	RF Input
6	RF Output / Bias
1, 2, 4, 5	Ground

### Applications

- Mobile Infrastructure
- CATV / FTTH
- WLAN / ISM
- RFID
- WiMAX / WiBro

### Ordering Information

Part No.	Description
AG203-63G	3,000 pieces on a 7" reel (standard)
AG203-63PCB	700 - 2400 MHz Assembled Evaluation Board

## Absolute Maximum Ratings

Parameter	Rating
Storage Temperature	-55 °C to +125 °C
Device Voltage (V <sub>DEVICE</sub> )	+4.5 V
RF Input Power, CW, 50 Ω, T=25 °C	+10 dBm
Junction Temperature	177 °C

Exceeding any one or a combination of the Absolute Maximum Rating conditions may cause permanent damage to the device. Extended application of Absolute Maximum Rating conditions to the device may reduce device reliability.

## Recommended Operating Conditions

Parameter	Min	Typ	Max	Units
DC Supply Voltage	+4.75	+5	+5.25	V
T <sub>CASE</sub>	-40		+85	°C
T <sub>CASE, Operational</sub>	-55		+105	°C
T <sub>J</sub> for 10 <sup>6</sup> hours MTTF			+177	°C

Electrical specifications are measured at specified test conditions. Specifications are not guaranteed over all recommended operating conditions.

## Electrical Specifications

Parameter	Conditions <sup>(1)</sup>	Min	Typ	Max	Units
Operational Frequency Range		DC		6000	MHz
Test Frequency			900		MHz
Gain			19.7		dB
Input Return Loss			20		dB
Output Return Loss			16		dB
Output P1dB			+8		dBm
Output IP3	P <sub>out</sub> = -10 dBm/tone, Δf = 10 MHz		+20.1		dBm
Output IP2			+24		dBm
Noise Figure			3.0		dB
Test Frequency			1900		MHz
Gain		16.8	17.8	18.8	dB
Output P1dB			+7.4		dBm
Output IP3	P <sub>out</sub> = -10 dBm/tone, Δf = 10 MHz		+19.7		dBm
Device Voltage			4.05		V
Device Current			20		mA
Thermal Resistance, θ <sub>Jc</sub>	Junction to case			472	°C/W

Notes:

1. Test conditions unless otherwise noted: Supply Voltage = +5.0 V, R<sub>BIAS</sub> = 47.5 Ω, Temp = +25 °C, 50 Ω system.

## Typical Performance

Parameter	Typical								Units
Frequency	100	500	900	1900	2140	2400	3500	5800	MHz
S21	20.4	20.3	19.7	17.7	17.3	16.7	14.9	11.5	dB
S11	-25	-25	-20	-18	-16	-16	-20	-20	dB
S22	-14	-16	-16	-16	-16	-16	-20	-14	dB
Output P1dB	+8.2	+8.1	+8.0	+7.4	+6.8	+6.8	+6.6	--	dBm
Output IP3 <sup>(1)</sup>	+20.3	+20.2	+20.1	+19.7	+19.5	+19.5	--	--	dBm
Noise Figure	2.9	2.9	3.0	3.2	3.2	3.2	--	--	dB

**Notes:**

1. Test conditions unless otherwise stated: Supply Voltage = +5 V,  $V_{DEVICE} = +4.05V$ ,  $R_{BIAS} = 47.5 \Omega$ ,  $I_{CC} = 20 \text{ mA}$ ,  $T = 25 \text{ }^\circ\text{C}$ ,  $50 \Omega$  system
2. The OIP3 measured with two tones at an output power of -10 dBm / tone separated by 10 MHz. The suppression on the largest IMD3 product is used to calculate the OIP3 using a 2:1 rule.
3. Data is shown as device performance only. Actual implementation for the desired frequency band will be determined by external components shown in the application circuit.

## Optimal Operating Bias Point for Typical Performance

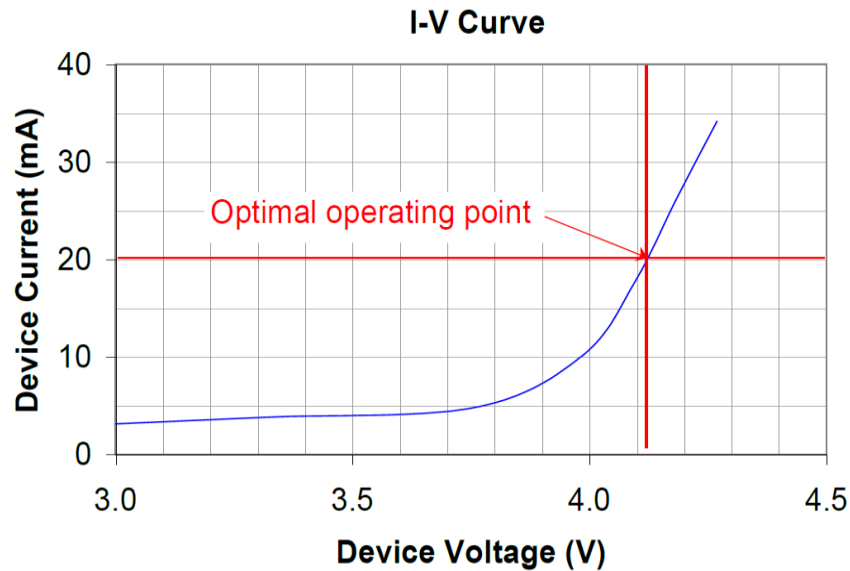

## S-Parameters

Freq (GHz)	S11 (dB)	S11 (ang)	S21 (dB)	S21 (ang)	S12 (dB)	S12 (ang)	S22 (dB)	S22 (ang)
50	-25.17	2.44	20.58	177.54	-23.20	1.82	-14.17	-3.37
250	-25.43	19.92	20.51	168.67	-23.93	4.61	-14.24	-8.75
500	-26.52	51.29	20.37	157.36	-23.52	3.76	-16.44	-18.23
750	-23.65	49.78	20.03	146.65	-23.46	5.05	-16.98	-30.04
1000	-22.07	40.71	19.64	136.55	-23.56	2.97	-17.77	-41.16
1250	-20.63	39.53	19.22	126.53	-23.03	6.36	-18.33	-55.53
1500	-19.78	35.18	18.75	117.55	-22.67	6.26	-18.95	-69.93
1750	-19.32	28.81	18.25	108.83	-22.55	8.11	-19.10	-85.56
2000	-18.82	22.65	17.69	100.49	-22.09	7.05	-19.08	-98.01
2250	-15.68	16.21	17.13	93.38	-21.84	7.56	-15.66	-96.28
2500	-16.33	9.66	16.75	88.14	-21.92	3.19	-16.65	-105.75
2750	-16.81	6.23	16.32	80.77	-21.04	4.47	-17.53	-113.94
3000	-17.51	4.58	15.86	74.01	-20.83	5.19	-19.10	-128.07
3250	-18.69	6.09	15.43	67.67	-20.59	5.81	-20.58	-142.56
3500	-19.88	9.58	15.01	61.27	-20.34	3.51	-22.15	-171.10
3750	-20.81	20.17	14.56	54.88	-19.86	1.07	-21.67	154.83
4000	-21.48	40.62	14.14	48.38	-19.12	0.00	-19.12	134.30
4250	-21.14	57.36	13.76	42.54	-19.02	-1.99	-16.77	118.64
4500	-19.74	72.23	13.30	36.58	-18.70	-6.17	-14.99	108.52
4750	-19.01	82.70	12.91	30.19	-18.67	-7.40	-14.02	104.45
5000	-18.41	89.08	12.54	24.69	-18.26	-10.48	-13.28	102.92
5250	-19.09	94.75	12.18	19.42	-18.05	-12.75	-13.13	100.56
5500	-20.88	99.20	11.82	14.41	-17.84	-14.26	-13.43	100.66
5750	-23.32	109.55	11.60	9.32	-17.44	-17.25	-14.24	103.15

Test conditions unless otherwise noted:  $V_{\text{DEVICE}} = +4.05 \text{ V}$ ,  $I_{\text{CC}} = 20 \text{ mA}$ ,  $T = 25 \text{ }^\circ\text{C}$ , calibrated reference planes to device leads

**700 MHz to 2400 MHz Evaluation Board – AG203-63PCB**

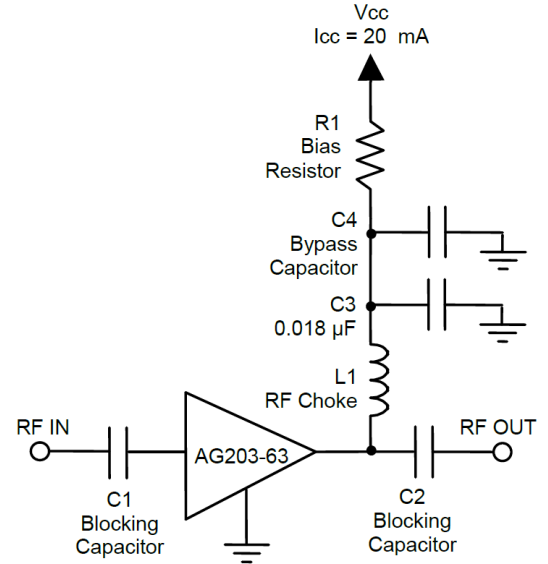
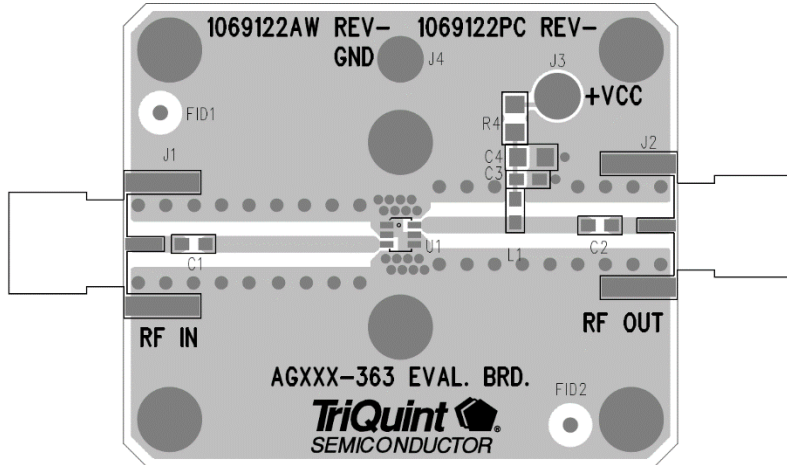

**Bill of Material – AG203-63PCB, 700 MHz to 2400 MHz**

Reference Des.	Value	Description	Manuf.	Part Number
n/a	n/a	Printed Circuit Board	Qorvo	
U1	n/a	Amplifier, AG203-63G	Qorvo	AG203-63G
L1	39 nH	Inductor, 39 nH, Wire wound, 0603, RF Choke	various	
C1, C2	56 pF	Capacitor, 56 pF, Chip, 0603, DC Blocking	various	
C3	0.018 $\mu$ F	Capacitor, 0.018 $\mu$ F, Chip, 0603, Bypass	various	
C4		Capacitor, Not Place, Bypass		
R1	47.5 $\Omega$	Resistor, 47.5 $\Omega$ , 1%, 0603, Bias	various	

Notes: This BOM configuration provides optimum broadband performance of the fully assembled evaluation board shipped from Qorvo.

**Component Values for Specific Frequencies**

Frequency	50 MHz	500 MHz	900 MHz	1900 MHz	2200 MHz	2500 MHz	3500 MHz
L1	820 nH	220 nH	68 nH	27 nH	22 nH	18 nH	15 nH
C1, C2, C4	.018 $\mu$ F	1000 pF	100 pF	68 pF	68 pF	56 pF	39 pF

**Bias Resistor Values for Specific Supply Voltages**

V <sub>SUPPLY</sub>	5 V	6 V	7 V	8 V	9 V	10 V	12 V
R1	47.5 $\Omega$	98 $\Omega$	148 $\Omega$	198 $\Omega$	248 $\Omega$	298 $\Omega$	398 $\Omega$
Component Size	0603	0603	0805	0805	1206	1210	1210

Notes: The R1 is for bias and its stability over temperature. The minimum V<sub>SUPPLY</sub> is +5 V. An 1% tolerance resistor is recommended.

Performance Plots, +5 V Supply Voltage

Test conditions unless otherwise stated: Supply Voltage = +5 V,  $V_{DEVICE} = +4.05V$ ,  $R_{BIAS} = 47.5 \Omega$ ,  $I_{CC} = 20 \text{ mA}$ ,  $T = 25 \text{ }^\circ\text{C}$ ,  $50 \Omega$  system

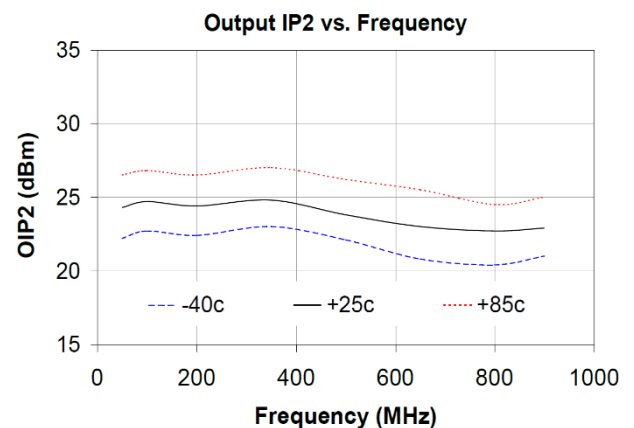
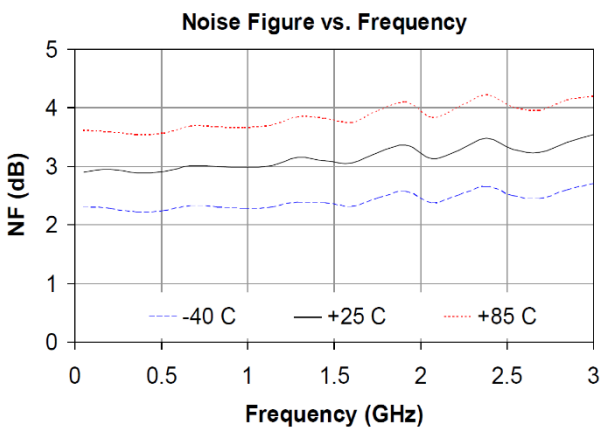
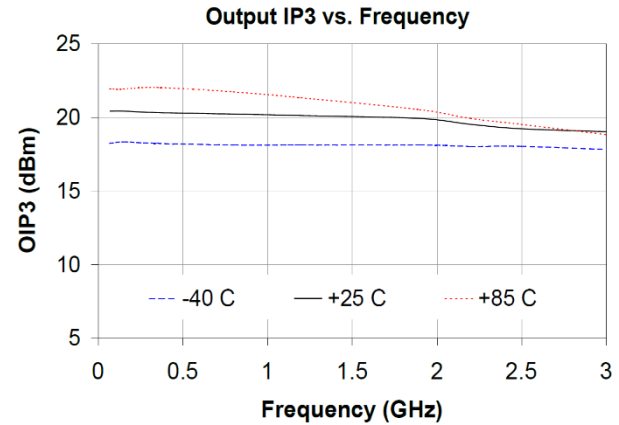
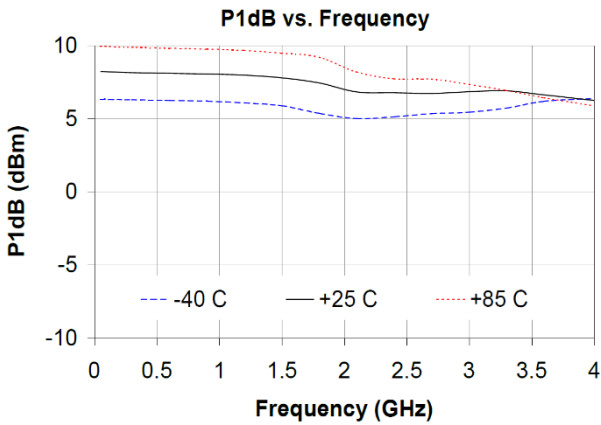
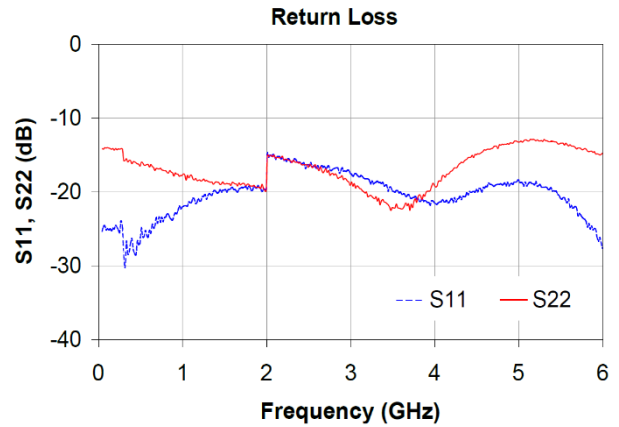
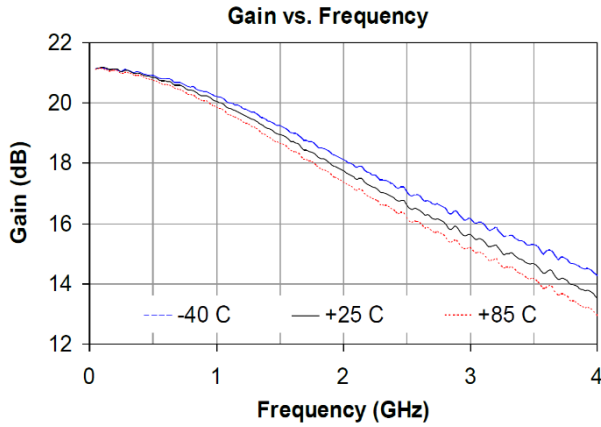

Performance Plots, +5 V Supply Voltage (continue)

Test conditions unless otherwise noted: Supply Voltage = +5 V,  $V_{DEVICE} = +4.05V$ ,  $R_{BIAS} = 47.5\ \Omega$ ,  $I_{CC} = 20\ mA$ ,  $T = 25\ ^\circ C$ ,  $50\ \Omega$  system

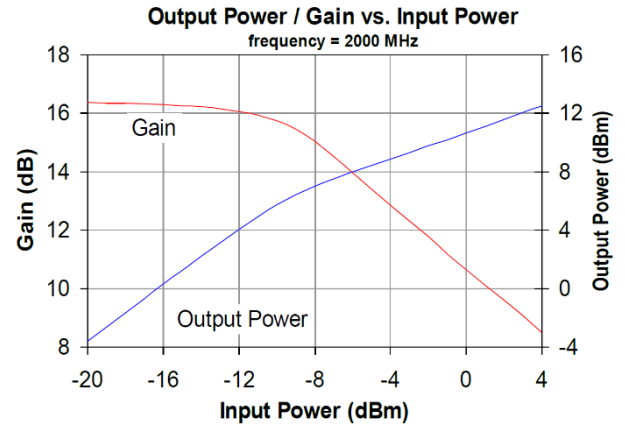
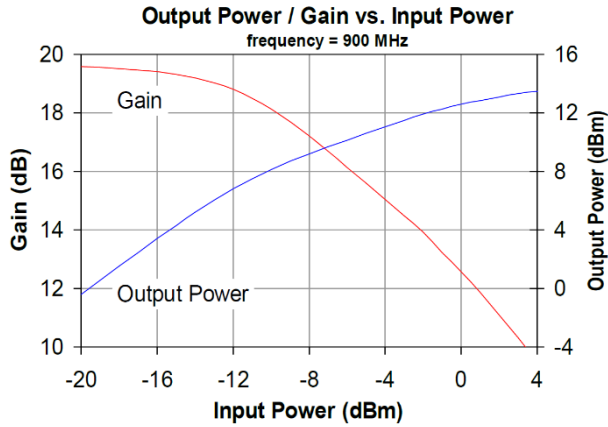

**Performance Plots, +6 V Supply Voltage**

Test conditions unless otherwise stated: Supply Voltage = +6 V,  $V_{DEVICE} = +4.05V$ ,  $R_{BIAS} = 98 \Omega$ ,  $I_{CC} = 20 \text{ mA}$ ,  $T = 25 \text{ }^\circ\text{C}$ ,  $50 \Omega$  system

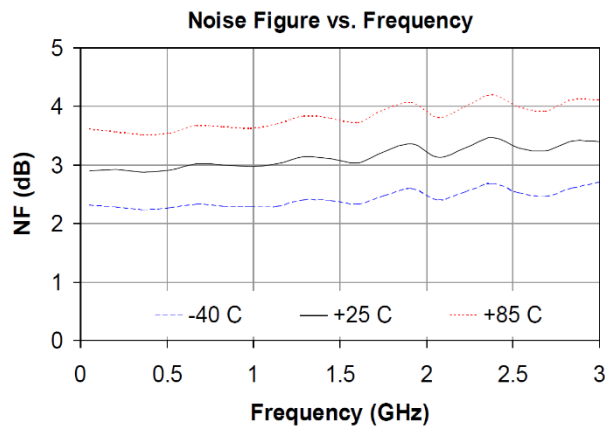
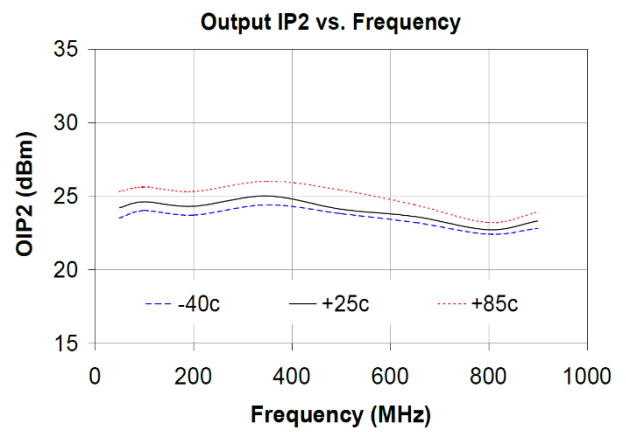
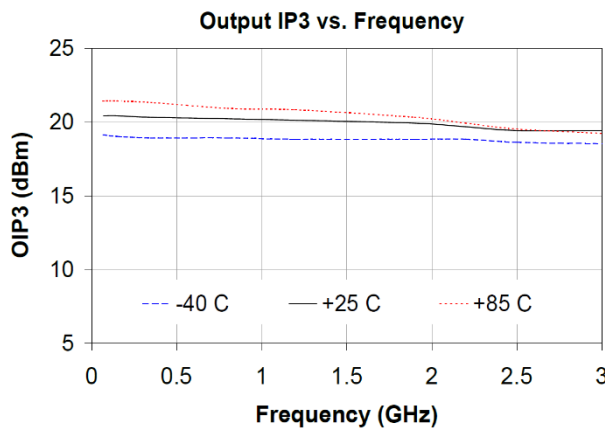
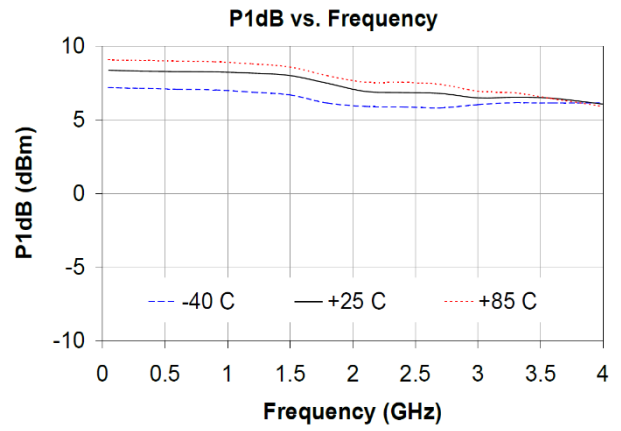
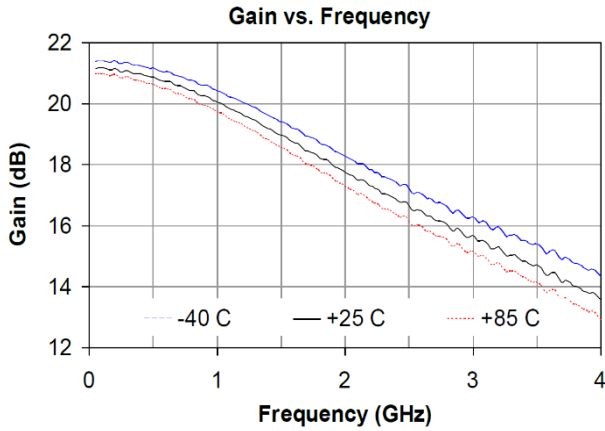



Performance Plots, +8 V Supply Voltage

Test conditions unless otherwise stated: Supply Voltage = +8 V,  $V_{DEVICE} = +4.05V$ ,  $R_{BIAS} = 198 \Omega$ ,  $I_{CC} = 20 \text{ mA}$ ,  $T = 25 \text{ }^\circ\text{C}$ ,  $50 \Omega$  system

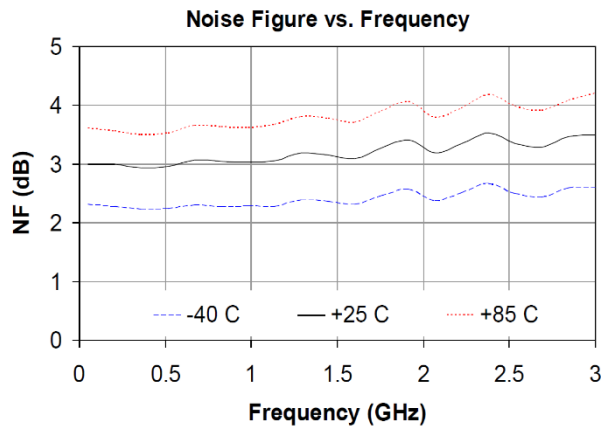
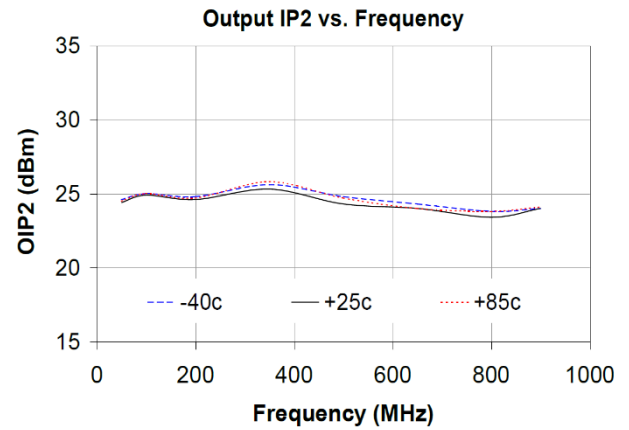
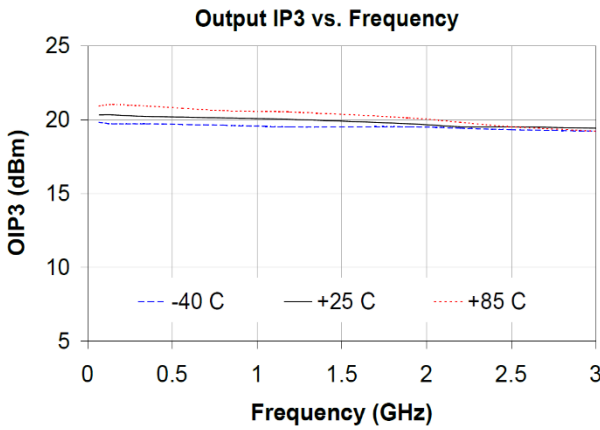
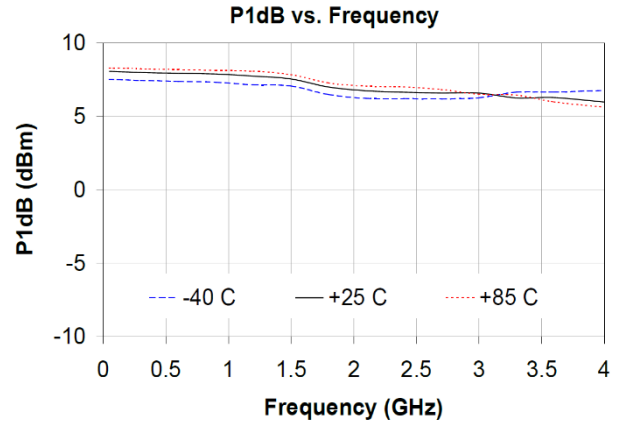
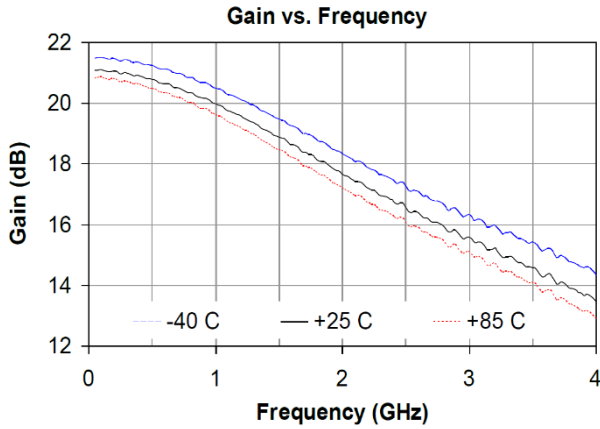

## Package Marking and Dimensions

Marking: HXX

H – Designator

XX – 2 Digit Lot Code

SYMBOL	MIN	MAX
A	—	1.10 (.043)
A1	0	.10 (.004)
A2	.70 (.028)	1.00 (.039)
D	2.00 (.079)	BASIC
E	2.10 (.083)	BASIC
E1	1.25 (.039)	BASIC
L	.21 (.008)	.41 (.016)
L1	.42 (.017)	RFF
L2	.15 (.006)	BASIC
$\theta$	0°	8°
$\theta_1$	4°	12°
b	.15 (.006)	.30 (.012)
c	.08 (.003)	.22 (.009)
e	.65 (.026)	BASIC
e1	1.30 (.051)	BASIC

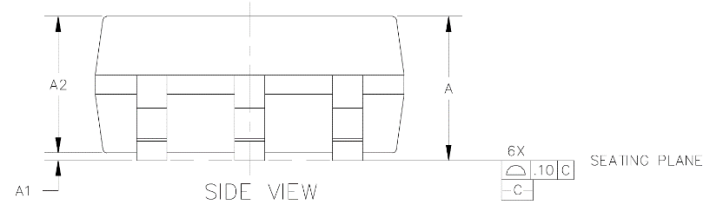
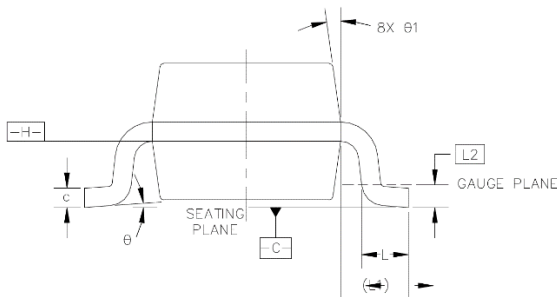
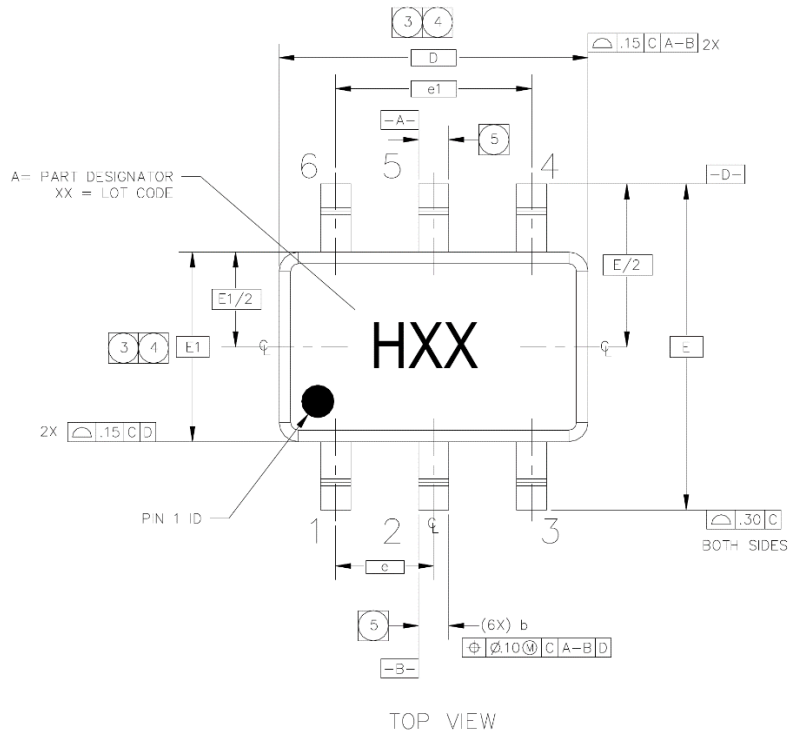

**NOTES:**

- DIMENSIONS AND TOLERANCING PER ASME Y14.5M-1194. PACKAGE CONFORMS TO JEDEC MO-203, ISSUE B.
- DIMENSIONS ARE IN MILLIMETERS (INCHES).
- DIMENSION D DOES NOT INCLUDE MOLD FLASH, PROTRUSIONS OR GATE BURRS. MOLD FLASH, PROTRUSIONS OR GATE BURRS SHALL NOT EXCEED 0.15 mm PER END. DIMENSION E1 DOES NOT INCLUDE INTERLEAD FLASH OR PROTRUSION. INTERLEAD FLASH OR PROTRUSION SHALL NOT EXCEED 0.15 mm PER SIDE. D AND E1 DIMENSIONS ARE DETERMINED AT DATUM H.
- THE PACKAGE TOP MAY BE SMALLER THAN THE PACKAGE BOTTOM. DIMENSIONS D AND E1 ARE DETERMINED AT THE OUTERMOST EXTREMES OF THE PLASTIC BODY EXCLUSIVE OF MOLD FLASH, I.E. BAR BURRS, GATE BURRS AND INTERLEAD FLASH, BUT INCLUDING ANY MISMATCH BETWEEN THE TOP AND THE BOTTOM OF THE PLASTIC BODY. D AND E1 DIMENSIONS ARE DETERMINED AT DATUM H.

- DATUM A & B TO BE DETERMINED AT DATUM H.
- DIMENSION 'b' DOES NOT INCLUDE DAMBAR PROTRUSION. ALLOWABLE DAMBAR PROTRUSION SHALL BE 0.08 mm TOTAL IN EXCESS OF THE "b" DIMENSION AT MAXIMUM MATERIAL CONDITION. THE DAMBAR IS NOT LOCATED ON THE LOWER RADIUS OF THE FOOT. MINIMUM SPACE BETWEEN PROTRUSION AND AN ADJACENT LEAD SHALL NOT BE LESS THAN 0.07 mm.

**Notes:**

- All dimensions are in millimeters with (inches). Angles are in degrees.
- The terminal #1 identifier and terminal numbering conform to JEDEC 95-1 SPP-012.

## PCB Mounting Land Pattern

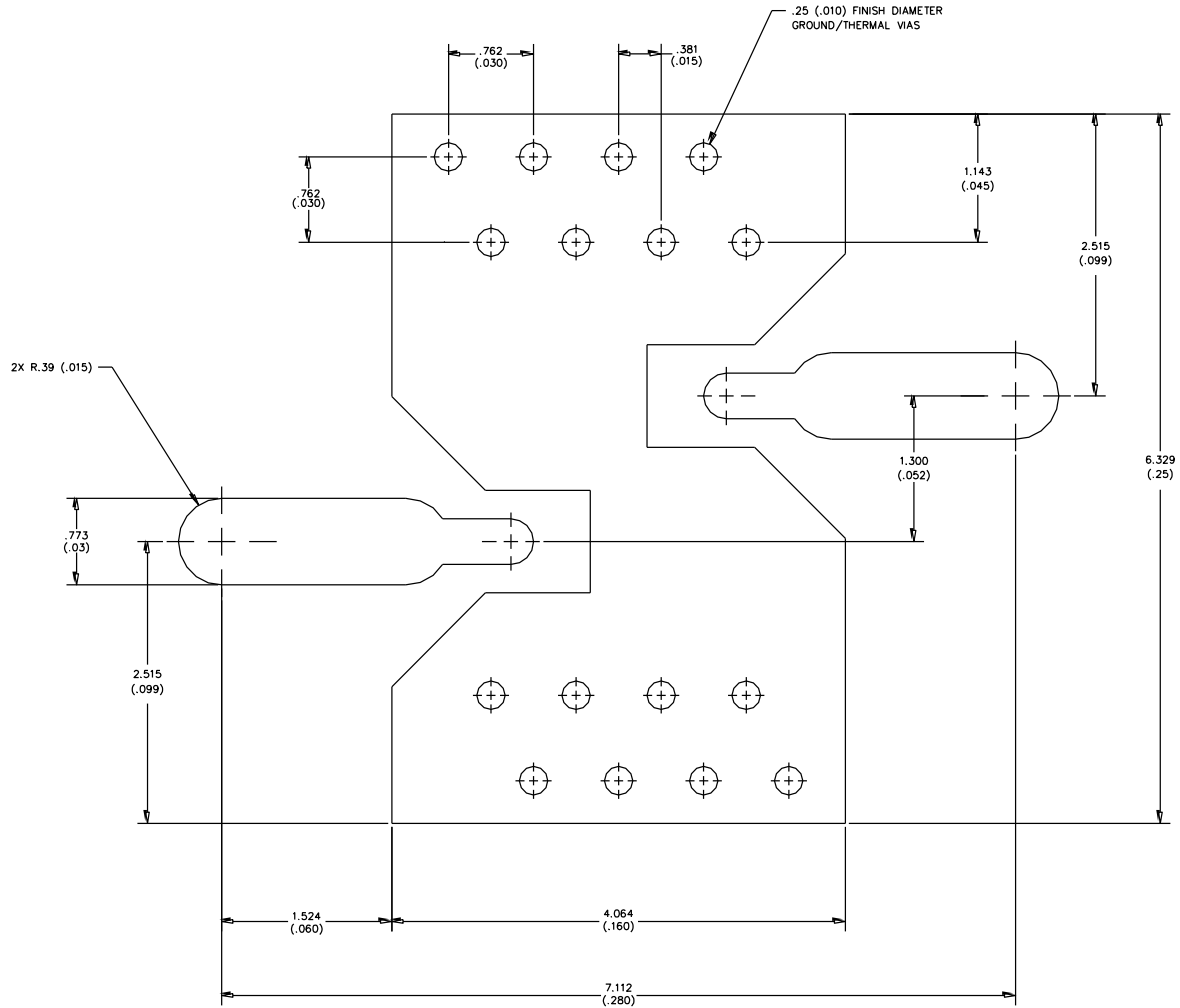

**Notes:**

1. Ground / thermal via holes are critical for the proper performance of this device. Via holes should use a 0.35 mm (#80 / .0135") diameter drill and have a final plated thru diameter of 0.25 mm (0.010").
2. Add as much copper as possible to inner and outer layers near the part to ensure optimal thermal performance.
3. Mounting screws can be added near the part to fasten the board to a heatsink. Ensure that the ground / thermal via region contacts the heatsink.
4. No solder mask on the backside of the PC board in the region where the board contacts the heatsink.
5. RF trace width depends upon the PC board material and construction.
6. Use 1 oz. Copper minimum.
7. All dimensions are in millimeters (inches). Angles are in degrees.

**Tape and Reel Information – Carrier and Cover Tape Dimensions**

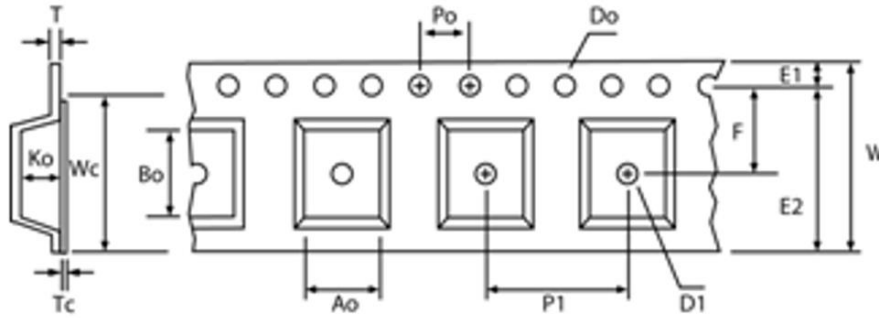

Feature	Measure	Symbol	Size (in)	Size (mm)
Cavity	Length	A0	0.089	2.25
	Width	B0	0.094	2.40
	Depth	K0	0.047	1.20
	Pitch	P1	0.157	4.00
Centerline Distance	Cavity to Perforation - Length Direction	P2	0.079	2.00
	Cavity to Perforation - Width Direction	F	0.138	3.50
Cover Tape	Width	C	0.213	5.40
Carrier Tape	Width	W	0.315	8.00

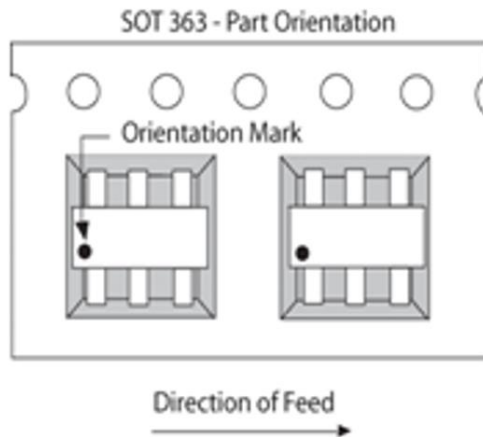

**Tape and Reel Information – Reel Dimensions**

Standard T/R size = 3,000 pieces on a 7" reel.

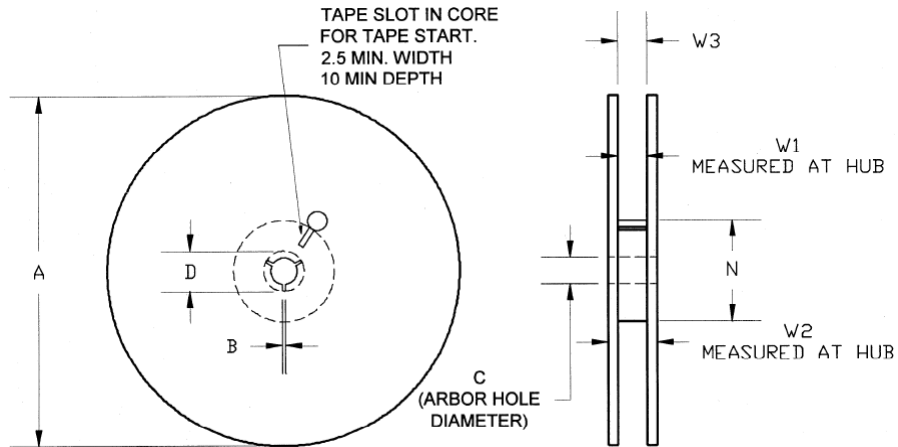

Feature	Measure	Symbol	Size (in)	Size (mm)
Flange	Diameter	A	6.969	177.0
	Thickness	W2	0.559	14.2
	Space Between Flange	W1	0.346	8.8
Hub	Outer Diameter	N	2.283	58.0
	Arbor Hole Diameter	C	0.512	13.0
	Key Slit Width	B	0.079	2.0
	Key Slit Diameter	D	0.787	20.0

**Tape and Reel Information – Tape Length and Label Placement**

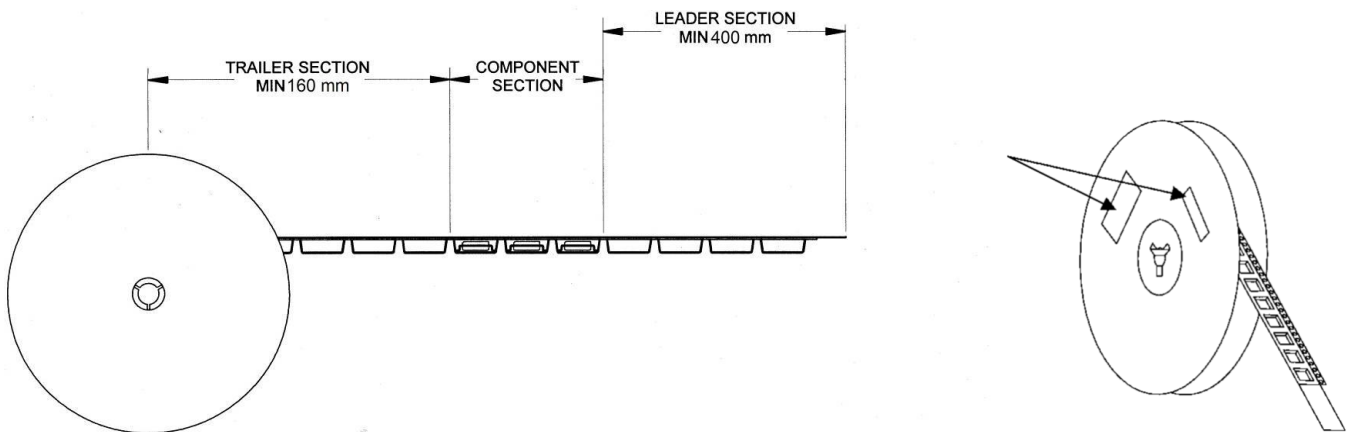

- Notes:
1. Empty part cavities at the trailing and leading ends are sealed with cover tape. See EIA 481-1-A.
  2. Labels are placed on the flange opposite the sprockets in the carrier tape.

## Handling Precautions

Parameter	Rating	Standard
ESD – Human Body Model (HBM)	Class 1C	ESDA / JEDEC JS-001-2012
ESD – Charged Device Model (CDM)	Class C3	JEDEC JESD22-C101F
MSL – Moisture Sensitivity Level	Level 3	IPC/JEDEC J-STD-020



Caution!  
 ESD-Sensitive Device

## Solderability

Compatible with both lead-free (260°C max. reflow temp.) and tin/lead (245°C max. reflow temp.) soldering processes. Solder profiles available upon request.

Contact plating: Matte Tin

## RoHS Compliance

This part is compliant with 2011/65/EU RoHS directive (Restrictions on the Use of Certain Hazardous Substances in Electrical and Electronic Equipment) as amended by Directive 2015/863/EU.

This product also has the following attributes:

- Lead Free
- Halogen Free (Chlorine, Bromine)
- Antimony Free
- TBBP-A (C<sub>15</sub>H<sub>12</sub>Br<sub>4</sub>O<sub>2</sub>) Free
- PFOS Free
- SVHC Free



## Contact Information

For the latest specifications, additional product information, worldwide sales and distribution locations:

**Web:** [www.qorvo.com](http://www.qorvo.com)

**Tel:** 1-844-890-8163

**Email:** [customer.support@qorvo.com](mailto:customer.support@qorvo.com)

For technical questions and application information:

**Email:** [appsupport@qorvo.com](mailto:appsupport@qorvo.com)

## Important Notice

The information contained herein is believed to be reliable; however, Qorvo makes no warranties regarding the information contained herein and assumes no responsibility or liability whatsoever for the use of the information contained herein. All information contained herein is subject to change without notice. Customers should obtain and verify the latest relevant information before placing orders for Qorvo products. The information contained herein or any use of such information does not grant, explicitly or implicitly, to any party any patent rights, licenses, or any other intellectual property rights, whether with regard to such information itself or anything described by such information. **THIS INFORMATION DOES NOT CONSTITUTE A WARRANTY WITH RESPECT TO THE PRODUCTS DESCRIBED HEREIN, AND QORVO HEREBY DISCLAIMS ANY AND ALL WARRANTIES WITH RESPECT TO SUCH PRODUCTS WHETHER EXPRESS OR IMPLIED BY LAW, COURSE OF DEALING, COURSE OF PERFORMANCE, USAGE OF TRADE OR OTHERWISE, INCLUDING THE IMPLIED WARRANTIES OF MERCHANTABILITY AND FITNESS FOR A PARTICULAR PURPOSE.**

Without limiting the generality of the foregoing, Qorvo products are not warranted or authorized for use as critical components in medical, life-saving, or life-sustaining applications, or other applications where a failure would reasonably be expected to cause severe personal injury or death.

Copyright 2019 © Qorvo, Inc. | Qorvo is a registered trademark of Qorvo, Inc.

Компания «Life Electronics» занимается поставками электронных компонентов импортного и отечественного производства от производителей и со складов крупных дистрибьюторов Европы, Америки и Азии.

С конца 2013 года компания активно расширяет линейку поставок компонентов по направлению коаксиальный кабель, кварцевые генераторы и конденсаторы (керамические, пленочные, электролитические), за счёт заключения дистрибьюторских договоров

Мы предлагаем:

- Конкуренспособные цены и скидки постоянным клиентам.
- Специальные условия для постоянных клиентов.
- Подбор аналогов.
- Поставку компонентов в любых объемах, удовлетворяющих вашим потребностям.
- Приемлемые сроки поставки, возможна ускоренная поставка.
- Доставку товара в любую точку России и стран СНГ.
- Комплексную поставку.
- Работу по проектам и поставку образцов.
- Формирование склада под заказчика.
- Сертификаты соответствия на поставляемую продукцию (по желанию клиента).
- Тестирование поставляемой продукции.
- Поставку компонентов, требующих военную и космическую приемку.
- Входной контроль качества.
- Наличие сертификата ISO.

В составе нашей компании организован Конструкторский отдел, призванный помогать разработчикам, и инженерам.

Конструкторский отдел помогает осуществить:

- Регистрацию проекта у производителя компонентов.
- Техническую поддержку проекта.
- Защиту от снятия компонента с производства.
- Оценку стоимости проекта по компонентам.
- Изготовление тестовой платы монтаж и пусконаладочные работы.



Тел: +7 (812) 336 43 04 (многоканальный)

Email: [org@lifeelectronics.ru](mailto:org@lifeelectronics.ru)