



SERIES: VQA | DESCRIPTION: DC-DC CONVERTER

FEATURES

- designed for IGBT driver modules
- small footprint
- 3,000 Vac isolation
- short circuit protection
- temperature range (-40~105°C)
- UL 60950-1 approval
- efficiency up to 80%



MODEL

MODEL	input voltage		output voltage (Vdc)	output current max (mA)	ripple and noise ² max (mVp-p)	efficiency ³ typ (%)
	typ (Vdc)	range (Vdc)				
VQA-S9-D15-SIP ¹	12	9~15	15 -8	100 -80	200	80
VQA-S12-D15-SIP ¹	12	11.6~12.4	15 -8.7	80 -40	200	80
VQA-S15-S9-SIP	15	14.5~15.5	9	111	200	80
VQA-S15-D9-SIP	15	14.5~15.5	9 -9	55 -55	200	80
VQA-S15-D15-SIP ¹	15	14.5~15.5	15 -8.7	80 -40	200	80
VQA-S15-D17-SIP ¹	15	14.5~15.5	17 -8.7	80 -40	200	80
VQA-S24-D15-SIP ¹	24	23.3~24.7	15 -8.7	80 -40	200	80

Notes: 1. UL approved
2. Ripple and noise are measured at 20 MHz BW by "parallel cable" method with 1 μ F ceramic and 10 μ F electrolytic capacitors on the output.
3. at full load

PART NUMBER KEY

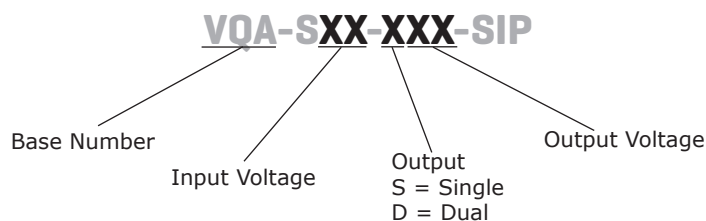

INPUT

parameter	conditions/description	min	typ	max	units
input voltage	VQA-S9-D15-SIP	9	12	15	Vdc
	VQA-S12-D15-SIP	11.6	12	12.4	Vdc
	VQA-S24-D15-SIP	23.3	24	24.7	Vdc
	all other models	14.5	15	15.5	Vdc
surge voltage	VQA-S9-D15-SIP	-0.7		15	Vdc
	VQA-S12-D15-SIP	-0.7		13	Vdc
	VQA-S24-D15-SIP	-0.7		26	Vdc
	all other models	-0.7		16	Vdc
temperature coefficient	at full load			±0.03	%/°C

OUTPUT

parameter	conditions/description	min	typ	max	units
capacitive load				200	μF
line regulation	for Vin change of ±1%		1.2	1.5	%
switching frequency	at full load, nominal input		100	200	kHz

PROTECTIONS

parameter	conditions/description	min	typ	max	units
short circuit protection ¹				1	s

Notes: 1. The supply voltage must be discontinued at the end of the short circuit duration

SAFETY AND COMPLIANCE

parameter	conditions/description	min	typ	max	units
isolation voltage	input to output for 1 minute at 1 mA max. leakage	3,000			Vac
isolation resistance	input to output at 500 Vdc	1,000			MΩ
isolation capacitance	input to output, 100 kHz/0.1 V		6.6		pF
safety approvals ²	UL 60950-1				
conducted emissions	CISPR22/EN55022, class B, external circuit required (see figure 1)				
radiated emissions	CISPR22/EN55022, class B, external circuit required (see figure 1)				
ESD	IEC/EN61000-4-2, contact ±8kV, class B				
MTBF	as per MIL-HDBK-217F @ 25°C	3,500,000			hours
RoHS	2011/65/EU				

Notes: 2. See specific models listed on page 1

ENVIRONMENTAL

parameter	conditions/description	min	typ	max	units
operating temperature	see derating curve	-40		105	°C
storage temperature		-55		125	°C
storage humidity	non-condensing			95	%

SOLDERABILITY

parameter	conditions/description	min	typ	max	units
hand soldering	1.5mm from case for 10 seconds			300	°C

MECHANICAL

parameter	conditions/description	min	typ	max	units
dimensions	19.50 x 9.80 x 12.5 (0.768 x 0.386 x 0.492 inch)				mm
material	plastic (UL94V-0)				
weight			4.3		g
temperature rise	Ta=25°C		25		°C

MECHANICAL DRAWING

units: mm [inches]
 tolerance: ±0.50 [±0.020]
 pin section tolerance: ±0.10 [±0.004]

PIN CONNECTIONS	
PIN	FUNCTION
1	Vin
2	GND
5*	-Vo
6	0 V
7	+Vo

Note: *VQA-S15-S9-SIP has no connection

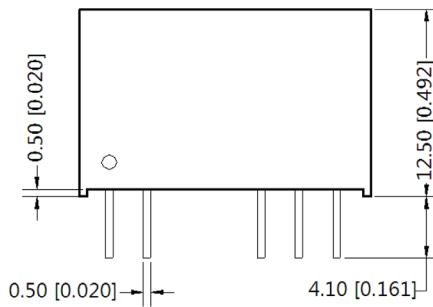

Front View



Grid size: 2.54mm x 2.54mm

Top View
PCB LAYOUT

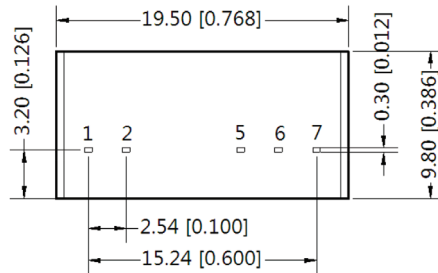

Bottom View

DERATING CURVES

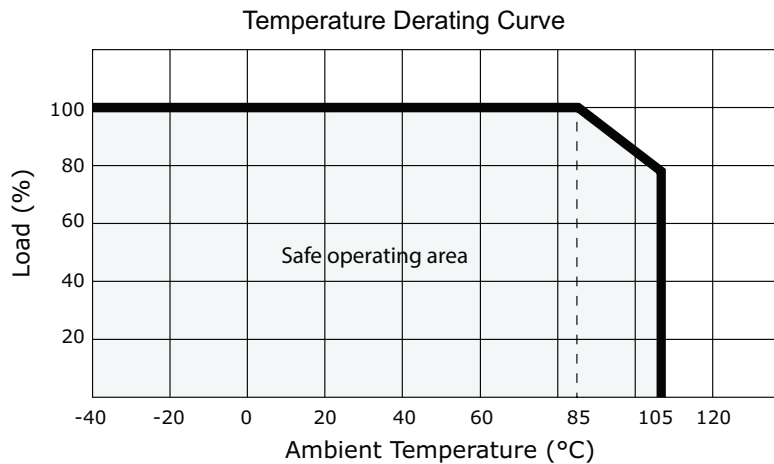

PERFORMANCE CURVES

1. output current vs. efficiency

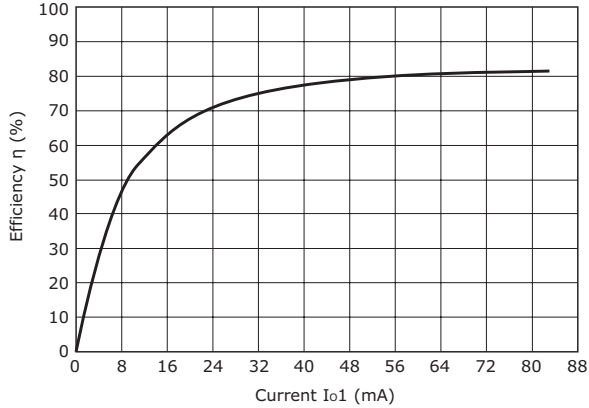

VQA-S12-D15-SIP, VQA-S15-D15-SIP, VQA-S24-D15-SIP

2. output current vs. output voltage

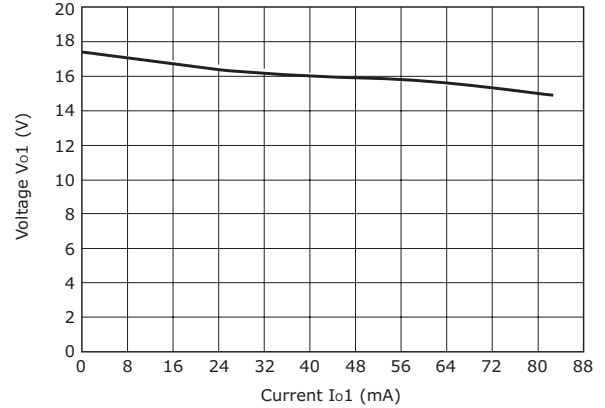

VQA-S12-D15-SIP, VQA-S15-D15-SIP, VQA-S24-D15-SIP

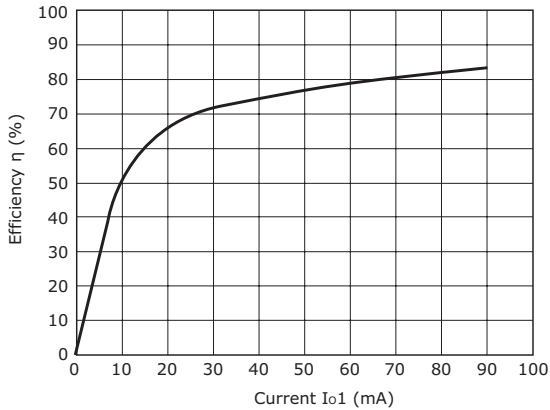

VQA-S15-D17-SIP

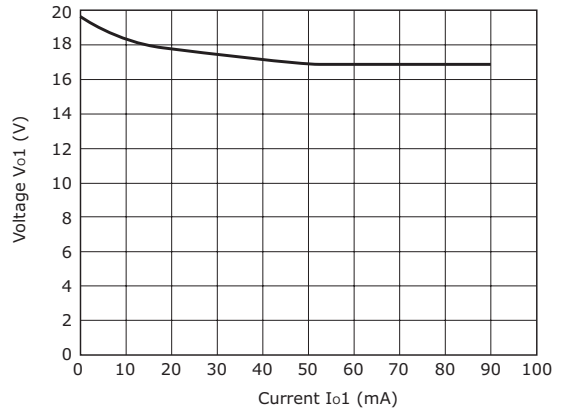

VQA-S15-D17-SIP

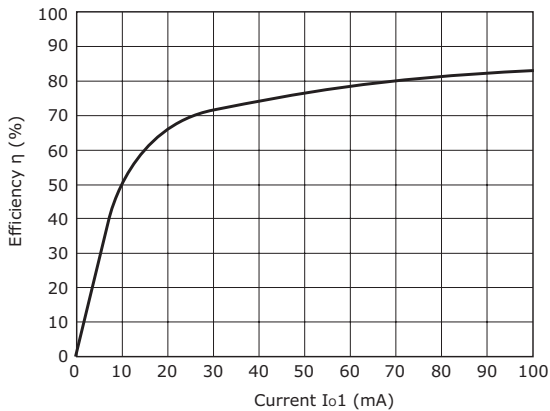

VQA-S9-D15-SIP

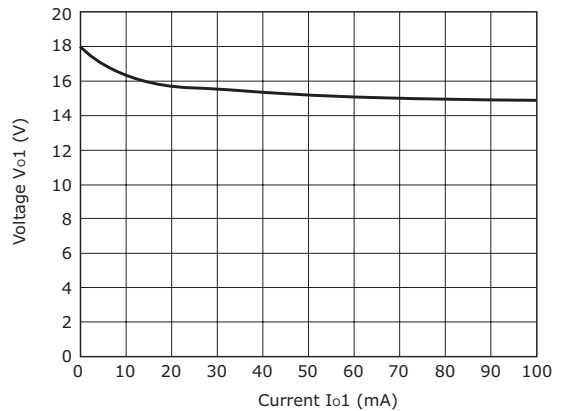

VQA-S9-D15-SIP

PERFORMANCE CURVES (CONTINUED)

1. output current vs. efficiency



VQA-S15-S9-SIP

2. output current vs. output voltage

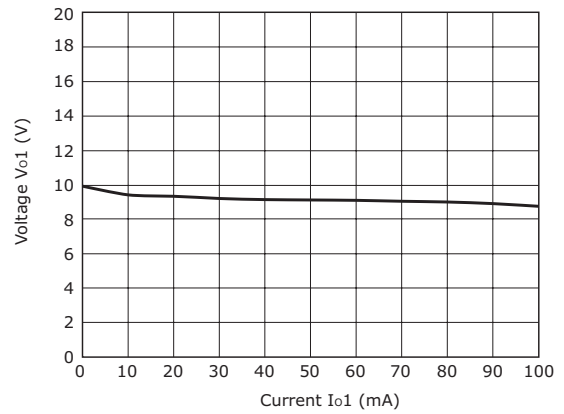

VQA-S15-S9-SIP

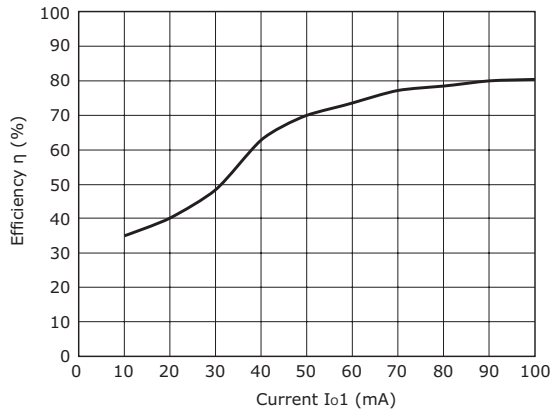

VQA-S15-D9-SIP

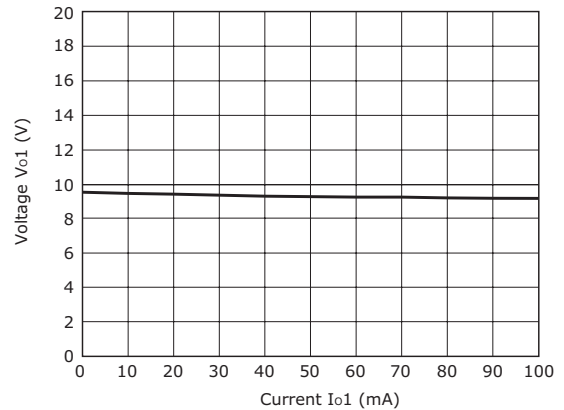

VQA-S15-D9-SIP

EMC RECOMMENDED CIRCUIT



Figure 1

Table 1

Recommended external circuit components		
V_{in} (Vdc)	C1	LDM
12	4.7 μ F/50V	12 μ H
15	4.7 μ F/50V	12 μ H
24	4.7 μ F/50V	12 μ H

TEST CONFIGURATION

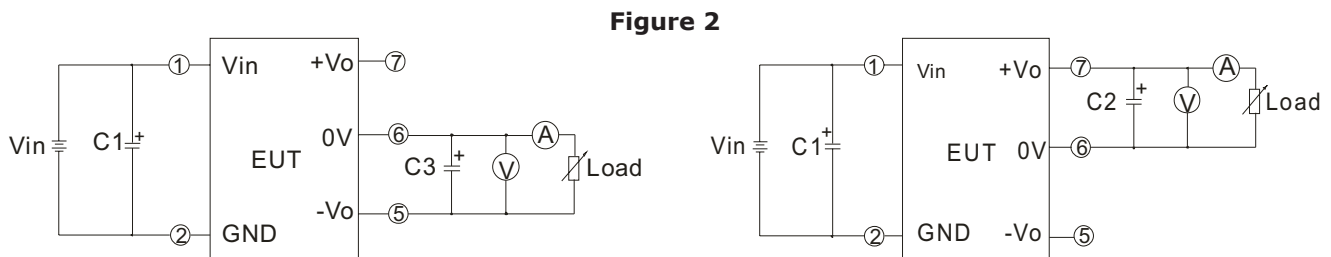
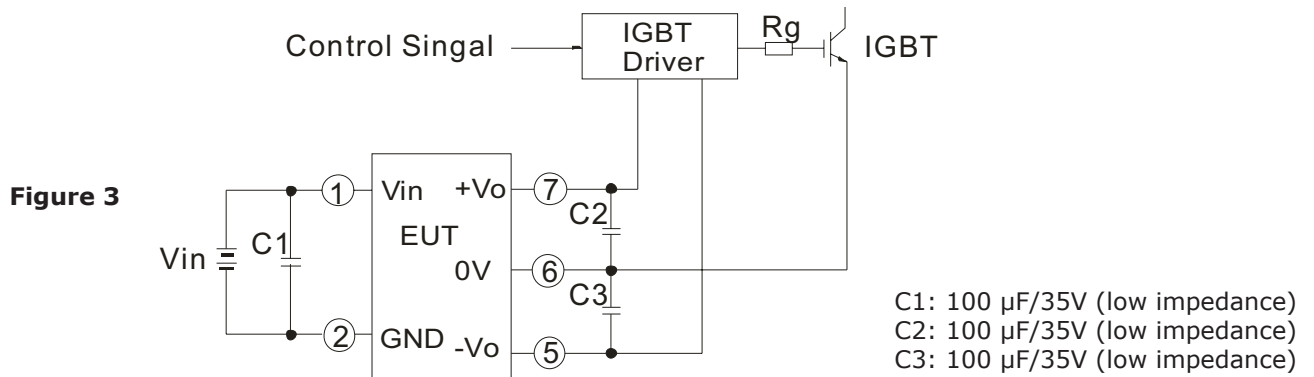

Figure 2

C1, C2, C3: 100 μ F/35V (low impedance)

APPLICATION CIRCUIT



- Notes:
1. The wire between the converter and IGBT driver must as short as possible.
 2. External filter capacitors should be connected as close as possible to the converter and the IGBT driver.
 3. The output average power of the IGBT driver should be less than the output power of DC-DC module.
 4. Maximum capacitive load is tested at nominal input voltage and full load.

REVISION HISTORY

rev.	description	date
1.0	initial release	08/16/2012
1.01	updated features	09/20/2012
1.02	updated product photograph	11/13/2012
1.03	various updates	02/05/2013
1.04	added switching frequency to spec	07/01/2013
1.05	added models, updated spec	09/23/2013
1.06	added UL to some models	02/12/2015

The revision history provided is for informational purposes only and is believed to be accurate.



CUI INC[®]

Headquarters
20050 SW 112th Ave.
Tualatin, OR 97062
800.275.4899

Fax 503.612.2383
cui.com
techsupport@cui.com

CUI offers a two (2) year limited warranty. Complete warranty information is listed on our website.

CUI reserves the right to make changes to the product at any time without notice. Information provided by CUI is believed to be accurate and reliable. However, no responsibility is assumed by CUI for its use, nor for any infringements of patents or other rights of third parties which may result from its use.

CUI products are not authorized or warranted for use as critical components in equipment that requires an extremely high level of reliability. A critical component is any component of a life support device or system whose failure to perform can be reasonably expected to cause the failure of the life support device or system, or to affect its safety or effectiveness.

Компания «Life Electronics» занимается поставками электронных компонентов импортного и отечественного производства от производителей и со складов крупных дистрибьюторов Европы, Америки и Азии.

С конца 2013 года компания активно расширяет линейку поставок компонентов по направлению коаксиальный кабель, кварцевые генераторы и конденсаторы (керамические, пленочные, электролитические), за счёт заключения дистрибьюторских договоров

Мы предлагаем:

- Конкурентоспособные цены и скидки постоянным клиентам.
- Специальные условия для постоянных клиентов.
- Подбор аналогов.
- Поставку компонентов в любых объемах, удовлетворяющих вашим потребностям.
- Приемлемые сроки поставки, возможна ускоренная поставка.
- Доставку товара в любую точку России и стран СНГ.
- Комплексную поставку.
- Работу по проектам и поставку образцов.
- Формирование склада под заказчика.
- Сертификаты соответствия на поставляемую продукцию (по желанию клиента).
- Тестирование поставляемой продукции.
- Поставку компонентов, требующих военную и космическую приемку.
- Входной контроль качества.
- Наличие сертификата ISO.

В составе нашей компании организован Конструкторский отдел, призванный помогать разработчикам, и инженерам.

Конструкторский отдел помогает осуществить:

- Регистрацию проекта у производителя компонентов.
- Техническую поддержку проекта.
- Защиту от снятия компонента с производства.
- Оценку стоимости проекта по компонентам.
- Изготовление тестовой платы монтаж и пусконаладочные работы.



Тел: +7 (812) 336 43 04 (многоканальный)

Email: org@lifeelectronics.ru