

### General Description

The 9ZXL1950 is a DB1900Z derivative buffer utilizing Low-Power HCSL (LP-HCSL) outputs to increase edge rates on long traces, reduce board space, and reduce power consumption more than 50% from the original 9ZX21901. It is pin-compatible to the 9ZXL1930 and fully integrates the output terminations. It is suitable for PCI-Express Gen1/2/3 or QPI/UPI applications, and uses a fixed external feedback to maintain low drift for demanding QPI/UPI applications.

### Recommended Application

Buffer for Romley, Grantley and Purley Servers

### Output Features

19 LP-HCSL output pairs w/integrated terminations ( $Z_o = 85\Omega$ )

### Key Specifications

- Cycle-to-cycle jitter: <50ps
- Output-to-output skew: <50ps
- Input-to-output delay variation: <50ps
- Phase jitter: PCIe Gen3 <1ps rms
- Phase jitter: QPI/UPI 9.6GB/s <0.2ps rms

### Features/Benefits

- LP-HCSL outputs; up to 90% IO power reduction, better signal integrity over long traces
- Direct connect to 85Ω transmission lines; eliminates 76 termination resistors, saves 130mm<sup>2</sup> area
- Pin compatible to the 9ZXL1930; easy upgrade to reduced board space
- 72-pin VFQFPN package; smallest 19-output Z-buffer
- Fixed feedback path; ~0ps input-to-output delay
- 9 Selectable SMBus addresses; multiple devices can share same SMBus segment
- Separate VDDIO for outputs; allows maximum power savings
- PLL or bypass mode; PLL can dejitter incoming clock
- 100MHz & 133.33MHz PLL mode; legacy QPI support
- Selectable PLL BW; minimizes jitter peaking in downstream PLL's
- Spread spectrum compatible; tracks spreading input clock for EMI reduction
- SMBus Interface; unused outputs can be disabled

### Block Diagram

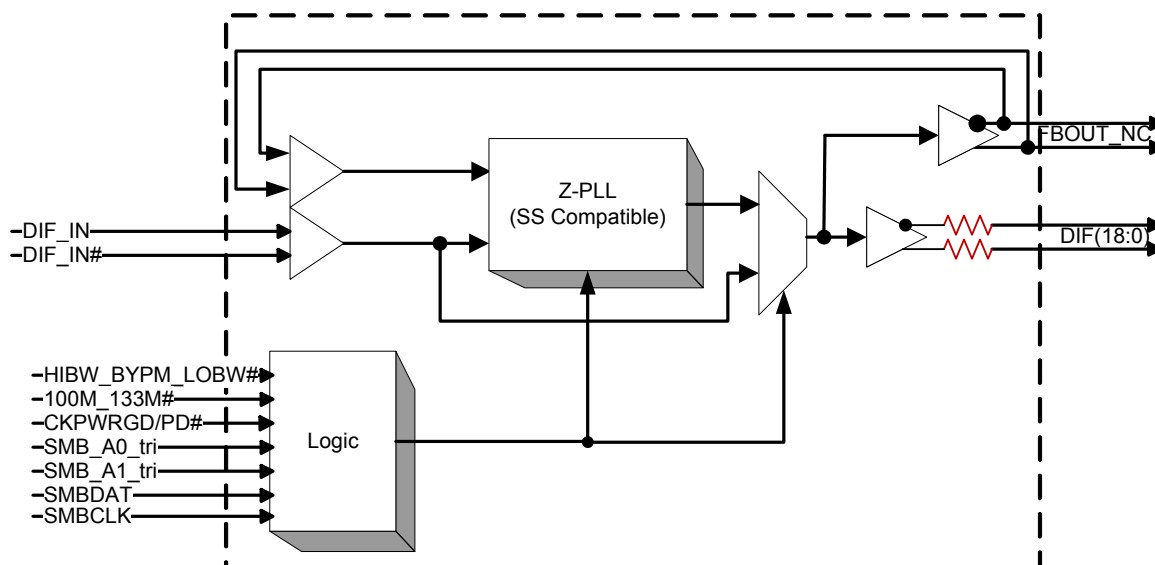

# Pin Configuration

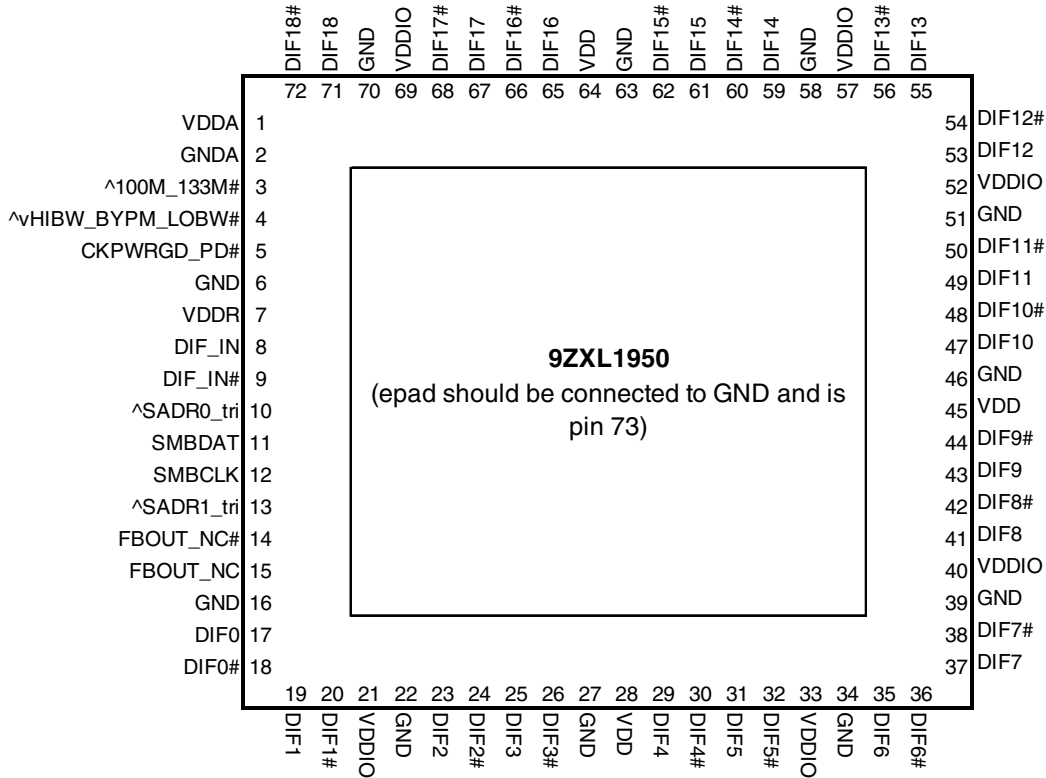

Note: Pins with ^ prefix have internal 120K pullup  
 Pins with v prefix have internal 120K pulldown  
 Pins with ^v prefix have internal 120K pullup/pulldown (biased to VDD/2)

## Power Management Table

| Inputs      |                    | Control Bits    | Outputs        |                         | PLL State |
|-------------|--------------------|-----------------|----------------|-------------------------|-----------|
| CKPWRGD_PD# | DIF_IN/<br>DIF_IN# | SMBus<br>EN bit | DIFx/<br>DIFx# | FBOUT_NC/<br>FB_OUT_NC# |           |
| 0           | X                  | X               | Low/Low        | Low/Low                 | OFF       |
| 1           | Running            | 0               | Low/Low        | Running                 | ON        |
|             |                    | 1               | Running        | Running                 | ON        |

## Power Connections

| Pin Number |                           |  | Description  |
|------------|---------------------------|--|--------------|
| VDD        | VDDIO                     | GND  |              |
| 1          |                           | 2  | Analog PLL   |
| 7          |                           | 6  | Analog Input |
| 28, 45, 64 | 21, 33, 40,<br>52, 57, 69 | 16, 22, 27, 34,<br>39, 46, 51, 58,<br>63, 70, 73 | DIF clocks   |

## Functionality at Power-up (PLL mode)

| 100M_133M# | DIF_IN<br>(MHz) | DIFx<br>(MHz) |
|------------|-----------------|---------------|
| 1          | 100.00          | DIF_IN        |
| 0          | 133.33          | DIF_IN        |

## PLL Operating Mode

| HiBW_BypM_LoBW#    | Byte0, bit (7:6) |
|--------------------|------------------|
| Low ( PLL Low BW)  | 00               |
| Mid (Bypass)       | 01               |
| High (PLL High BW) | 11               |

NOTE: PLL is off in Bypass mode

## Tri-level Input Thresholds

| Level | Voltage      |
|-------|--------------|
| Low   | <0.8V        |
| Mid   | 1.2<Vin<1.8V |
| High  | Vin > 2.2V   |

## Pin Descriptions

| PIN # | PIN NAME          | PIN TYPE   | DESCRIPTION   |
|-------|-------------------|------------|---|
| 1     | VDDA              | PWR        | Power for the PLL core.   |
| 2     | GNDA              | GND        | Ground pin for the PLL core.  |
| 3     | ^100M_133M#       | IN         | 3.3V Input to select operating frequency. This pin has an internal pull-up resistor. See Functionality Table for Definition   |
| 4     | ^vHIBW_BYPM_LOBW# | LATCHED IN | Trilevel input to select High BW, Bypass or Low BW mode. See PLL Operating Mode Table for Details.  |
| 5     | CKPWRGD_PD#       | IN         | 3.3V Input notifies device to sample latched inputs and start up on first high assertion, or exit Power Down Mode on subsequent assertions. Low enters Power Down Mode.                 |
| 6     | GND               | GND        | Ground pin.   |
| 7     | VDDR              | PWR        | 3.3V power for differential input clock (receiver). This VDD should be treated as an analog power rail and filtered appropriately.  |
| 8     | DIF_IN            | IN         | HCSL True input   |
| 9     | DIF_IN#           | IN         | HCSL Complementary Input  |
| 10    | ^SADR0_tri        | IN         | SMBus address bit. This is a tri-level input that works in conjunction with the SADR1 to decode 1 of 9 SMBus Addresses. It has an internal 120Kohm pull up resistor.                    |
| 11    | SMBDAT            | I/O        | Data pin of SMBUS circuitry, 5V tolerant  |
| 12    | SMBCLK            | IN         | Clock pin of SMBUS circuitry, 5V tolerant   |
| 13    | ^SADR1_tri        | IN         | SMBus address bit. This is a tri-level input that works in conjunction with the SADR0 to decode 1 of 9 SMBus Addresses. It has an internal 120Kohm pull up resistor.                    |
| 14    | FBOUT_NC#         | OUT        | Complementary half of differential feedback output. This pin should NOT be connected to anything outside the chip. It exists to provide delay path matching to get 0 propagation delay. |
| 15    | FBOUT_NC          | OUT        | True half of differential feedback output. This pin should NOT be connected to anything outside the chip. It exists to provide delay path matching to get 0 propagation delay.          |
| 16    | GND               | GND        | Ground pin.   |
| 17    | DIF0              | OUT        | Differential true clock output  |
| 18    | DIF0#             | OUT        | Differential Complementary clock output   |
| 19    | DIF1              | OUT        | Differential true clock output  |
| 20    | DIF1#             | OUT        | Differential Complementary clock output   |
| 21    | VDDIO             | PWR        | Power supply for differential outputs   |
| 22    | GND               | GND        | Ground pin.   |
| 23    | DIF2              | OUT        | Differential true clock output  |
| 24    | DIF2#             | OUT        | Differential Complementary clock output   |
| 25    | DIF3              | OUT        | Differential true clock output  |
| 26    | DIF3#             | OUT        | Differential Complementary clock output   |
| 27    | GND               | GND        | Ground pin.   |
| 28    | VDD               | PWR        | Power supply, nominal 3.3V  |
| 29    | DIF4              | OUT        | Differential true clock output  |
| 30    | DIF4#             | OUT        | Differential Complementary clock output   |
| 31    | DIF5              | OUT        | Differential true clock output  |
| 32    | DIF5#             | OUT        | Differential Complementary clock output   |
| 33    | VDDIO             | PWR        | Power supply for differential outputs   |
| 34    | GND               | GND        | Ground pin.   |
| 35    | DIF6              | OUT        | Differential true clock output  |
| 36    | DIF6#             | OUT        | Differential Complementary clock output   |

## Pin Descriptions (cont.)

| PIN # | PIN NAME | PIN TYPE | DESCRIPTION                             |
|-------|----------|----------|---|
| 37    | DIF7     | OUT      | Differential true clock output          |
| 38    | DIF7#    | OUT      | Differential Complementary clock output |
| 39    | GND      | GND      | Ground pin.                             |
| 40    | VDDIO    | PWR      | Power supply for differential outputs   |
| 41    | DIF8     | OUT      | Differential true clock output          |
| 42    | DIF8#    | OUT      | Differential Complementary clock output |
| 43    | DIF9     | OUT      | Differential true clock output          |
| 44    | DIF9#    | OUT      | Differential Complementary clock output |
| 45    | VDD      | PWR      | Power supply, nominal 3.3V              |
| 46    | GND      | GND      | Ground pin.                             |
| 47    | DIF10    | OUT      | Differential true clock output          |
| 48    | DIF10#   | OUT      | Differential Complementary clock output |
| 49    | DIF11    | OUT      | Differential true clock output          |
| 50    | DIF11#   | OUT      | Differential Complementary clock output |
| 51    | GND      | GND      | Ground pin.                             |
| 52    | VDDIO    | PWR      | Power supply for differential outputs   |
| 53    | DIF12    | OUT      | Differential true clock output          |
| 54    | DIF12#   | OUT      | Differential Complementary clock output |
| 55    | DIF13    | OUT      | Differential true clock output          |
| 56    | DIF13#   | OUT      | Differential Complementary clock output |
| 57    | VDDIO    | PWR      | Power supply for differential outputs   |
| 58    | GND      | GND      | Ground pin.                             |
| 59    | DIF14    | OUT      | Differential true clock output          |
| 60    | DIF14#   | OUT      | Differential Complementary clock output |
| 61    | DIF15    | OUT      | Differential true clock output          |
| 62    | DIF15#   | OUT      | Differential Complementary clock output |
| 63    | GND      | GND      | Ground pin.                             |
| 64    | VDD      | PWR      | Power supply, nominal 3.3V              |
| 65    | DIF16    | OUT      | Differential true clock output          |
| 66    | DIF16#   | OUT      | Differential Complementary clock output |
| 67    | DIF17    | OUT      | Differential true clock output          |
| 68    | DIF17#   | OUT      | Differential Complementary clock output |
| 69    | VDDIO    | PWR      | Power supply for differential outputs   |
| 70    | GND      | GND      | Ground pin.                             |
| 71    | DIF18    | OUT      | Differential true clock output          |
| 72    | DIF18#   | OUT      | Differential Complementary clock output |
| 73    | epad     | GND      | Connect EPAD to ground.                 |

## Electrical Characteristics–Absolute Maximum Ratings

| PARAMETER                 | SYMBOL             | CONDITIONS                 | MIN     | TYP | MAX                   | UNITS | NOTES |
|---------------------------|--------------------|----------------------------|---------|-----|-----------------------|-------|-------|
| 3.3V Core Supply Voltage  | VDDA, R            |                            |         |     | 4.6                   | V     | 1,2   |
| 3.3V Logic Supply Voltage | VDD                |                            |         |     | 4.6                   | V     | 1,2   |
| I/O Supply Voltage        | VDDIO              |                            |         |     | 4.6                   | V     | 1,2   |
| Input Low Voltage         | V <sub>IL</sub>    |                            | GND-0.5 |     |                       | V     | 1     |
| Input High Voltage        | V <sub>IH</sub>    | Except for SMBus interface |         |     | V <sub>DD</sub> +0.5V | V     | 1     |
| Input High Voltage        | V <sub>IHSMB</sub> | SMBus clock and data pins  |         |     | 5.5V                  | V     | 1     |
| Storage Temperature       | T <sub>s</sub>     |                            | -65     |     | 150                   | °C    | 1     |
| Junction Temperature      | T <sub>j</sub>     |                            |         |     | 125                   | °C    | 1     |
| Input ESD protection      | ESD prot           | Human Body Model           | 2000    |     |                       | V     | 1     |

<sup>1</sup>Guaranteed by design and characterization, not 100% tested in production.

<sup>2</sup>Operation under these conditions is neither implied nor guaranteed.

## Electrical Characteristics–DIF\_IN Clock Input Parameters

T<sub>A</sub> = T<sub>COM</sub>; Supply Voltage VDD/VDDA = 3.3 V +/-5%, VDDIO = 1.05 to 3.3V +/-5%. See Test Loads for Loading Conditions

| PARAMETER                        | SYMBOL             | CONDITIONS  | MIN | TYP | MAX | UNITS | NOTES |
|----------------------------------|--------------------|---|-----|-----|-----|-------|-------|
| Input Crossover Voltage - DIF_IN | V <sub>CROSS</sub> | Cross Over Voltage  | 150 |     | 900 | mV    | 1     |
| Input Swing - DIF_IN             | V <sub>SWING</sub> | Differential value  | 300 |     |     | mV    | 1     |
| Input Slew Rate - DIF_IN         | dv/dt              | Measured differentially                                   | 0.4 |     | 8   | V/ns  | 1,2   |
| Input Leakage Current            | I <sub>IN</sub>    | V <sub>IN</sub> = V <sub>DD</sub> , V <sub>IN</sub> = GND | -5  |     | 5   | uA    |       |
| Input Duty Cycle                 | d <sub>tin</sub>   | Measurement from differential waveform                    | 45  |     | 55  | %     | 1     |
| Input Jitter - Cycle to Cycle    | J <sub>DIFIN</sub> | Differential Measurement                                  | 0   |     | 125 | ps    | 1     |

<sup>1</sup>Guaranteed by design and characterization, not 100% tested in production.

<sup>2</sup>Slew rate measured through +/-75mV window centered around differential zero

## Electrical Characteristics–Current Consumption

T<sub>A</sub> = T<sub>COM</sub>; Supply Voltage VDD/VDDA = 3.3 V +/-5%, VDDIO = 1.05 to 3.3V +/-5%. See Test Loads for Loading Conditions

| PARAMETER                | SYMBOL                  | CONDITIONS   | MIN | TYP | MAX | UNITS | NOTES |
|--------------------------|-------------------------|--|-----|-----|-----|-------|-------|
| Operating Supply Current | I <sub>DDVDD</sub>      | All outputs 100MHz, C <sub>L</sub> = 2pF; Z <sub>o</sub> = 85Ω |     | 20  | 35  | mA    |       |
|                          | I <sub>DDVDDA/R</sub>   | All outputs 100MHz, C <sub>L</sub> = 2pF; Z <sub>o</sub> = 85Ω |     | 15  | 20  | mA    |       |
|                          | I <sub>DDVDDIO</sub>    | All outputs 100MHz, C <sub>L</sub> = 2pF; Z <sub>o</sub> = 85Ω |     | 142 | 185 | mA    |       |
| Powerdown Current        | I <sub>DDVDDPD</sub>    | All differential pairs low-low                                 |     | 2.2 | 6   | mA    |       |
|                          | I <sub>DDVDDA/RPD</sub> | All differential pairs low-low                                 |     | 4.5 | 9   | mA    |       |
|                          | I <sub>DDVDDIOPD</sub>  | All differential pairs low-low                                 |     | 0.1 | 1   | mA    |       |

## Electrical Characteristics–Input/Supply/Common Output Parameters

TA = T<sub>COM</sub>; Supply Voltage VDD/VDDA = 3.3 V +/-5%, VDDIO = 1.05 to 3.3V +/-5%. See Test Loads for Loading Conditions

| PARAMETER                     | SYMBOL                | CONDITIONS  | MIN       | TYP    | MAX                   | UNITS | NOTES |
|-------------------------------|-----------------------|---|-----------|--------|-----------------------|-------|-------|
| Ambient Operating Temperature | T <sub>COM</sub>      | Commercial range  | 0         | 35     | 70                    | °C    |       |
| Input High Voltage            | V <sub>IH</sub>       | Single-ended inputs, except SMBus, low threshold and tri-level inputs   | 2         |        | V <sub>DD</sub> + 0.3 | V     |       |
| Input Low Voltage             | V <sub>IL</sub>       | Single-ended inputs, except SMBus, low threshold and tri-level inputs   | GND - 0.3 |        | 0.8                   | V     |       |
| Input Current                 | I <sub>IN</sub>       | Single-ended inputs, V <sub>IN</sub> = GND, V <sub>IN</sub> = VDD   | -5        |        | 5                     | uA    |       |
|                               | I <sub>INP</sub>      | Single-ended inputs<br>V <sub>IN</sub> = 0 V; Inputs with internal pull-up resistors<br>V <sub>IN</sub> = VDD; Inputs with internal pull-down resistors | -200      |        | 200                   | uA    |       |
| Input Frequency               | F <sub>ibyp</sub>     | V <sub>DD</sub> = 3.3 V, Bypass mode  | 33        |        | 150                   | MHz   | 2     |
|                               | F <sub>ipll</sub>     | V <sub>DD</sub> = 3.3 V, 100MHz PLL mode  | 90        | 100.00 | 110                   | MHz   | 2     |
|                               | F <sub>ipll</sub>     | V <sub>DD</sub> = 3.3 V, 133.33MHz PLL mode   | 120       | 133.33 | 147                   | MHz   | 2     |
| Pin Inductance                | L <sub>pin</sub>      |   |           |        | 7                     | nH    | 1     |
| Capacitance                   | C <sub>IN</sub>       | Logic Inputs, except DIF_IN   | 1.5       |        | 5                     | pF    | 1     |
|                               | C <sub>INDIF_IN</sub> | DIF_IN differential clock inputs  | 1.5       |        | 2.7                   | pF    | 1,4   |
|                               | C <sub>OUT</sub>      | Output pin capacitance  |           |        | 6                     | pF    | 1     |
| Clk Stabilization             | T <sub>STAB</sub>     | From V <sub>DD</sub> Power-Up and after input clock stabilization or de-assertion of PD# to 1st clock   |           | 0.65   | 1                     | ms    | 2     |
| Input SS Modulation Frequency | f <sub>MODIN</sub>    | Allowable Frequency (Triangular Modulation)   | 30        | 31.5   | 33                    | kHz   |       |
| Tdrive_PD#                    | t <sub>DRVPD</sub>    | DIF output enable after PD# de-assertion  |           | 25     | 300                   | us    | 1,3   |
| Tfall                         | t <sub>F</sub>        | Fall time of control inputs   |           |        | 5                     | ns    | 1,2   |
| Trise                         | t <sub>R</sub>        | Rise time of control inputs   |           |        | 5                     | ns    | 1,2   |
| SMBus Input Low Voltage       | V <sub>ILSMB</sub>    |   |           |        | 0.8                   | V     |       |
| SMBus Input High Voltage      | V <sub>IHSMB</sub>    |   | 2.1       |        | V <sub>DD</sub> SMB   | V     |       |
| SMBus Output Low Voltage      | V <sub>OLSMB</sub>    | @ I <sub>PULLUP</sub>   |           |        | 0.4                   | V     |       |
| SMBus Sink Current            | I <sub>PULLUP</sub>   | @ V <sub>OL</sub>   | 4         |        |                       | mA    |       |
| Nominal Bus Voltage           | V <sub>DD</sub> SMB   | 3V to 5V +/- 10%  | 2.7       |        | 5.5                   | V     |       |
| SCLK/SDATA Rise Time          | t <sub>RSMB</sub>     | (Max VIL - 0.15) to (Min VIH + 0.15)  |           |        | 1000                  | ns    | 1     |
| SCLK/SDATA Fall Time          | t <sub>FSMB</sub>     | (Min VIH + 0.15) to (Max VIL - 0.15)  |           |        | 300                   | ns    | 1     |
| SMBus Operating Frequency     | f <sub>SMB</sub>      | SMBus operating frequency   | 100       |        |                       | kHz   | 5     |

<sup>1</sup>Guaranteed by design and characterization, not 100% tested in production.

<sup>2</sup>Control input must be monotonic from 20% to 80% of input swing.

<sup>3</sup>Time from deassertion until outputs are >200 mV

<sup>4</sup>DIF\_IN input

<sup>5</sup>The differential input clock must be running for the SMBus to be active

## Electrical Characteristics–DIF 0.7V Low Power Differential Outputs

TA = T<sub>COM</sub>; Supply Voltage VDD/VDDA = 3.3 V +/-5%, VDDIO = 1.05 to 3.3V +/-5%. See Test Loads for Loading Conditions

| PARAMETER              | SYMBOL     | CONDITIONS  | MIN  | TYP | MAX  | UNITS | NOTES   |
|------------------------|------------|---|------|-----|------|-------|---------|
| Slew rate              | Trf        | Scope averaging on  | 1.5  | 2.7 | 4    | V/ns  | 1, 2, 3 |
| Slew rate matching     | ΔTrf       | Slew rate matching.   |      | 8.8 | 20   | %     | 1, 2, 4 |
| Voltage High           | VHigh      | Statistical measurement on single-ended signal using oscilloscope math function. (Scope averaging on) | 660  | 787 | 850  | mV    |         |
| Voltage Low            | VLow       |   | -150 | 33  | 150  |       |         |
| Max Voltage            | Vmax       | Single ended signal using absolute value. Includes 300mV of over/undershoot. (Scope                   |      | 845 | 1150 | mV    |         |
| Min Voltage            | Vmin       |   | -300 | 9   |      |       |         |
| Crossing Voltage (abs) | Vcross_abs | Scope averaging off   | 250  | 471 | 550  | mV    | 1, 5    |
| Crossing Voltage (var) | Δ-Vcross   | Scope averaging off   |      | 14  | 140  | mV    | 1, 6    |

<sup>1</sup>Guaranteed by design and characterization, not 100% tested in production. C<sub>L</sub> = 2pF with Zo = 85Ω differential trace impedance.

<sup>2</sup> Measured from differential waveform

<sup>3</sup> Slew rate is measured through the Vswing voltage range centered around differential 0V. This results in a +/-150mV window around differential 0V.

<sup>4</sup> Matching applies to rising edge rate for Clock and falling edge rate for Clock#. It is measured using a +/-75mV window centered on the average cross point where Clock rising meets Clock# falling. The median cross point is used to calculate the voltage thresholds the oscilloscope is to use for the edge rate calculations.

<sup>5</sup> Vcross is defined as voltage where Clock = Clock# measured on a component test board and only applies to the differential rising edge (i.e. Clock rising and Clock# falling).

<sup>6</sup> The total variation of all Vcross measurements in any particular system. Note that this is a subset of Vcross\_min/max (Vcross absolute) allowed. The intent is to limit Vcross induced modulation by setting Δ-Vcross to be smaller than Vcross absolute.

## Clock Periods–Differential Outputs with Spread Spectrum Disabled

| SSC OFF | Center Freq. MHz | Measurement Window     |                             |                             |                      |                             |                             |                        | Units | Notes |
|---------|------------------|------------------------|-----------------------------|-----------------------------|----------------------|-----------------------------|-----------------------------|------------------------|-------|-------|
|         |                  | 1 Clock                | 1us                         | 0.1s                        | 0.1s                 | 0.1s                        | 1us                         | 1 Clock                |       |       |
|         |                  | -c2c jitter AbsPer Min | -SSC Short-Term Average Min | - ppm Long-Term Average Min | 0 ppm Period Nominal | + ppm Long-Term Average Max | +SSC Short-Term Average Max | +c2c jitter AbsPer Max |       |       |
| DIF     | 100.00           | 9.94900                |                             | 9.99900                     | 10.00000             | 10.00100                    |                             | 10.05100               | ns    | 1,2,3 |
|         | 133.33           | 7.44925                |                             | 7.49925                     | 7.50000              | 7.50075                     |                             | 7.55075                | ns    | 1,2,4 |

## Clock Periods–Differential Outputs with Spread Spectrum Enabled

| SSC ON | Center Freq. MHz | Measurement Window     |                             |                             |                      |                             |                             |                        | Units | Notes |
|--------|------------------|------------------------|-----------------------------|-----------------------------|----------------------|-----------------------------|-----------------------------|------------------------|-------|-------|
|        |                  | 1 Clock                | 1us                         | 0.1s                        | 0.1s                 | 0.1s                        | 1us                         | 1 Clock                |       |       |
|        |                  | -c2c jitter AbsPer Min | -SSC Short-Term Average Min | - ppm Long-Term Average Min | 0 ppm Period Nominal | + ppm Long-Term Average Max | +SSC Short-Term Average Max | +c2c jitter AbsPer Max |       |       |
| DIF    | 99.75            | 9.94906                | 9.99906                     | 10.02406                    | 10.02506             | 10.02607                    | 10.05107                    | 10.10107               | ns    | 1,2,3 |
|        | 133.00           | 7.44930                | 7.49930                     | 7.51805                     | 7.51880              | 7.51955                     | 7.53830                     | 7.58830                | ns    | 1,2,4 |

### Notes:

<sup>1</sup> Guaranteed by design and characterization, not 100% tested in production.

<sup>2</sup> All Long Term Accuracy specifications are guaranteed with the assumption that the input clock complies with CK420BQ/CK410B+ accuracy requirements (+/-100ppm). The 9ZX1950 itself does not contribute to ppm error.

<sup>3</sup> Driven by SRC output of main clock, 100 MHz PLL Mode or Bypass mode

<sup>4</sup> Driven by CPU output of main clock, 133 MHz PLL Mode or Bypass mode

## Electrical Characteristics—Skew and Differential Jitter Parameters

TA = T<sub>COM</sub>; Supply Voltage VDD/VDDA = 3.3 V +/-5%, VDDIO = 1.05 to 3.3V +/-5%. See Test Loads for Loading Conditions

| PARAMETER              | SYMBOL                 | CONDITIONS  | MIN  | TYP  | MAX | UNITS       | NOTES     |
|------------------------|------------------------|---|------|------|-----|-------------|-----------|
| CLK_IN, DIF[x:0]       | t <sub>SPO_PLL</sub>   | Input-to-Output Skew in PLL mode<br>nominal value @ 35°C, 3.3V, 100MHz                      | -150 | -117 | -50 | ps          | 1,2,4,5,8 |
| CLK_IN, DIF[x:0]       | t <sub>PD_BYP</sub>    | Input-to-Output Skew in Bypass mode<br>nominal value @ 35°C, 3.3V                           | 2.5  | 3.6  | 4.5 | ns          | 1,2,3,5,8 |
| CLK_IN, DIF[x:0]       | t <sub>DSPO_PLL</sub>  | Input-to-Output Skew Variation in PLL mode<br>across voltage and temperature                | -50  | 0    | 50  | ps          | 1,2,3,5,8 |
| CLK_IN, DIF[x:0]       | t <sub>DSPO_BYP</sub>  | Input-to-Output Skew Variation in Bypass mode<br>across temperature for a given voltage     | -250 | 0    | 250 | ps          | 1,2,3,5,8 |
| CLK_IN, DIF[x:0]       | t <sub>DTE</sub>       | Random Differential Tracking error between two<br>9ZX devices in Hi BW Mode                 |      | 1    | 5   | ps<br>(rms) | 1,2,3,5,8 |
| CLK_IN, DIF[x:0]       | t <sub>DSSTE</sub>     | Random Differential Spread Spectrum Tracking<br>error between two 9ZX devices in Hi BW Mode |      | 5    | 75  | ps          | 1,2,3,5,8 |
| DIF[x:0]               | t <sub>SKREW_ALL</sub> | Output-to-Output Skew across all outputs<br>(Common to Bypass and PLL mode). 100MHz         |      | 37   | 50  | ps          | 1,2,3,8   |
| PLL Jitter Peaking     | j <sub>peak-hibw</sub> | LOBW#_BYPASS_HIBW = 1   | 0    | 1.8  | 2.5 | dB          | 7,8       |
| PLL Jitter Peaking     | j <sub>peak-lobw</sub> | LOBW#_BYPASS_HIBW = 0   | 0    | 0.7  | 2   | dB          | 7,8       |
| PLL Bandwidth          | p <sub>ll_HIBW</sub>   | LOBW#_BYPASS_HIBW = 1   | 2    | 3.3  | 4   | MHz         | 8,9       |
| PLL Bandwidth          | p <sub>ll_LOBW</sub>   | LOBW#_BYPASS_HIBW = 0   | 0.7  | 1.2  | 1.4 | MHz         | 8,9       |
| Duty Cycle             | t <sub>DC</sub>        | Measured differentially, PLL Mode   | 45   | 50   | 55  | %           | 1         |
| Duty Cycle Distortion  | t <sub>DCD</sub>       | Measured differentially, Bypass Mode<br>@100MHz   | 0    | 0.7  | 1.5 | %           | 1,10      |
| Jitter, Cycle to cycle | t <sub>jyc-cyc</sub>   | PLL mode  |      | 12   | 50  | ps          | 1,11      |
|                        |                        | Additive Jitter in Bypass Mode  |      | 0    | 10  | ps          | 1,11      |

### Notes for preceding table:

- <sup>1</sup> Measured into fixed 2 pF load cap. Input to output skew is measured at the first output edge following the corresponding input.
- <sup>2</sup> Measured from differential cross-point to differential cross-point. This parameter can be tuned with external feedback path, if present.
- <sup>3</sup> All Bypass Mode Input-to-Output specs refer to the timing between an input edge and the specific output edge created by it.
- <sup>4</sup> This parameter is deterministic for a given device
- <sup>5</sup> Measured with scope averaging on to find mean value.
- <sup>6</sup> t is the period of the input clock
- <sup>7</sup> Measured as maximum pass band gain. At frequencies within the loop BW, highest point of magnification is called PLL jitter peaking.
- <sup>8</sup> Guaranteed by design and characterization, not 100% tested in production.
- <sup>9</sup> Measured at 3 db down or half power point.
- <sup>10</sup> Duty cycle distortion is the difference in duty cycle between the output and the input clock when the device is operated in bypass mode.
- <sup>11</sup> Measured from differential waveform



## Electrical Characteristics–Phase Jitter Parameters

TA = T<sub>COM</sub>; Supply Voltage VDD/VDDA = 3.3 V +/-5%, VDDIO = 1.05 to 3.3V +/-5%. See Test Loads for Loading Conditions

| PARAMETER                             | SYMBOL                  | CONDITIONS   | MIN | TYP | MAX | UNITS    | Notes   |
|---------------------------------------|-------------------------|--|-----|-----|-----|----------|---------|
| Phase Jitter, PLL Mode                | t <sub>jphPCleG1</sub>  | PCle Gen 1   |     | 34  | 86  | ps (p-p) | 1,2,3   |
|                                       | t <sub>jphPCleG2</sub>  | PCle Gen 2 Lo Band<br>10kHz < f < 1.5MHz               |     | 1.2 | 3   | ps (rms) | 1,2     |
|                                       |                         | PCle Gen 2 High Band<br>1.5MHz < f < Nyquist (50MHz)   |     | 2.1 | 3.1 | ps (rms) | 1,2     |
|                                       | t <sub>jphPCleG3</sub>  | PCle Gen 3<br>(PLL BW of 2-4MHz, CDR = 10MHz)          |     | 0.5 | 1   | ps (rms) | 1,2,4   |
|                                       | t <sub>jphQPI_SMI</sub> | QPI & SMI<br>(100MHz or 133MHz, 4.8Gb/s, 6.4Gb/s 12UI) |     | 0.2 | 0.5 | ps (rms) | 1,5     |
|                                       |                         | QPI & SMI<br>(100MHz, 8.0Gb/s, 12UI)                   |     | 0.1 | 0.3 | ps (rms) | 1,5     |
|                                       |                         | QPI & SMI<br>(100MHz, 9.6Gb/s, 12UI)                   |     | 0.1 | 0.2 | ps (rms) | 1,5     |
| Additive Phase Jitter,<br>Bypass mode | t <sub>jphPCleG1</sub>  | PCle Gen 1   |     | 0.1 | 10  | ps (p-p) | 1,2,3   |
|                                       | t <sub>jphPCleG2</sub>  | PCle Gen 2 Lo Band<br>10kHz < f < 1.5MHz               |     | 0.1 | 0.3 | ps (rms) | 1,2,6   |
|                                       |                         | PCle Gen 2 High Band<br>1.5MHz < f < Nyquist (50MHz)   |     | 0.1 | 0.7 | ps (rms) | 1,2,6   |
|                                       | t <sub>jphPCleG3</sub>  | PCle Gen 3<br>(PLL BW of 2-4MHz, CDR = 10MHz)          |     | 0.0 | 0.3 | ps (rms) | 1,2,4,6 |
|                                       | t <sub>jphQPI_SMI</sub> | QPI & SMI<br>(100MHz or 133MHz, 4.8Gb/s, 6.4Gb/s 12UI) |     | 0.0 | 0.3 | ps (rms) | 1,5,6   |
|                                       |                         | QPI & SMI<br>(100MHz, 8.0Gb/s, 12UI)                   |     | 0.0 | 0.1 | ps (rms) | 1,5,6   |
|                                       |                         | QPI & SMI<br>(100MHz, 9.6Gb/s, 12UI)                   |     | 0.0 | 0.1 | ps (rms) | 1,5,6   |

<sup>1</sup> Applies to all outputs.

<sup>2</sup> See <http://www.pcisig.com> for complete specs

<sup>3</sup> Sample size of at least 100K cycles. This figures extrapolates to 108ps pk-pk @ 1M cycles for a BER of 1-12.

<sup>4</sup> Subject to final ratification by PCI SIG.

<sup>5</sup> Calculated from Intel-supplied Clock Jitter Tool v 1.6.4

<sup>6</sup> For RMS figures, additive jitter is calculated by solving the following equation: (Additive jitter)<sup>2</sup> = (total jitter)<sup>2</sup> - (input jitter)<sup>2</sup>

## Test Loads

### Differential Output Terminations

| DIF Zo (Ω) | Rs (Ω)            |
|------------|-------------------|
| 85         | Internal          |
| 100        | 7.5<br>(External) |

### 9ZXL Differential Test Loads

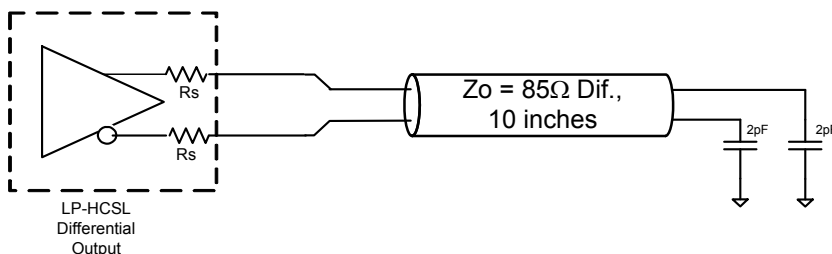

## General SMBus Serial Interface Information

### How to Write

- Controller (host) sends a start bit
- Controller (host) sends the write address
- IDT clock will **acknowledge**
- Controller (host) sends the beginning byte location = N
- IDT clock will **acknowledge**
- Controller (host) sends the byte count = X
- IDT clock will **acknowledge**
- Controller (host) starts sending Byte **N through Byte N+X-1**
- IDT clock will **acknowledge** each byte **one at a time**
- Controller (host) sends a Stop bit

| Index Block Write Operation |           |                      |
|-----------------------------|-----------|----------------------|
| Controller (Host)           |           | IDT (Slave/Receiver) |
| T                           | starT bit |                      |
| Slave Address               |           |                      |
| WR                          | WRite     |                      |
| Beginning Byte = N          |           | ACK                  |
|                             |           | ACK                  |
| Data Byte Count = X         |           | ACK                  |
| Beginning Byte N            |           | ACK                  |
| O                           | X Byte    | O                    |
| O                           |           | O                    |
| O                           |           | O                    |
| Byte N + X - 1              |           | ACK                  |
| P                           | stoP bit  |                      |

### How to Read

- Controller (host) will send a start bit
- Controller (host) sends the write address
- IDT clock will **acknowledge**
- Controller (host) sends the beginning byte location = N
- IDT clock will **acknowledge**
- Controller (host) will send a separate start bit
- Controller (host) sends the read address
- IDT clock will **acknowledge**
- IDT clock will send the data byte count = X
- IDT clock sends Byte **N+X-1**
- IDT clock sends **Byte 0 through Byte X (if X<sub>(H)</sub> was written to Byte 8)**
- Controller (host) will need to acknowledge each byte
- Controller (host) will send a not acknowledge bit
- Controller (host) will send a stop bit

| Index Block Read Operation |                 |                      |
|----------------------------|-----------------|----------------------|
| Controller (Host)          |                 | IDT (Slave/Receiver) |
| T                          | starT bit       |                      |
| Slave Address              |                 |                      |
| WR                         | WRite           |                      |
| Beginning Byte = N         |                 | ACK                  |
|                            |                 | ACK                  |
| RT                         | Repeat starT    |                      |
| Slave Address              |                 |                      |
| RD                         | ReaD            |                      |
|                            |                 | ACK                  |
| ACK                        |                 | Data Byte Count=X    |
| ACK                        |                 | Beginning Byte N     |
| O                          | X Byte          | O                    |
| O                          |                 | O                    |
| O                          |                 | O                    |
| O                          |                 | O                    |
|                            |                 | Byte N + X - 1       |
| N                          | Not acknowledge |                      |
| P                          | stoP bit        |                      |

**9ZX1950 SMBus Addressing**

| SADR(1:0)_tri | SMBus Address (Rd/Wrt bit = 0) |
|---------------|--------------------------------|
| 00            | D8                             |
| 0M            | DA                             |
| 01            | DE                             |
| M0            | C2                             |
| MM            | C4                             |
| M1            | C6                             |
| 10            | CA                             |
| 1M            | CC                             |
| 11            | CE                             |

**SMBusTable: PLL Mode, and Frequency Select Register**

| Byte 0 | Pin # | Name       | Control Function             | Type | 0                                     | 1      | Default |
|--------|-------|------------|------------------------------|------|---------------------------------------|--------|---------|
| Bit 7  | 4     | PLL Mode 1 | PLL Operating Mode Rd back 1 | R    | See PLL Operating Mode Readback Table |        | Latch   |
| Bit 6  | 4     | PLL Mode 0 | PLL Operating Mode Rd back 0 | R    | See PLL Operating Mode Readback Table |        | Latch   |
| Bit 5  | 72/71 | DIF_18_En  | Output Control               | RW   | Low/Low                               | Enable | 1       |
| Bit 4  | 68/67 | DIF_17_En  | Output Control               | RW   | Low/Low                               | Enable | 1       |
| Bit 3  | 66/65 | DIF_16_En  | Output Control               | RW   | Low/Low                               | Enable | 1       |
| Bit 2  |       | Reserved   |                              |      |                                       |        | 0       |
| Bit 1  |       | Reserved   |                              |      |                                       |        | 0       |
| Bit 0  | 3     | 100M_133M# | Frequency Select Readback    | R    | 133MHz                                | 100MHz | Latch   |

**SMBusTable: Output Control Register**

| Byte 1 | Pin # | Name     | Control Function | Type | 0       | 1      | Default |
|--------|-------|----------|------------------|------|---------|--------|---------|
| Bit 7  | 38/37 | DIF_7_En | Output Control   | RW   | Low/Low | Enable | 1       |
| Bit 6  | 35/36 | DIF_6_En | Output Control   | RW   |         |        | 1       |
| Bit 5  | 31/32 | DIF_5_En | Output Control   | RW   |         |        | 1       |
| Bit 4  | 29/30 | DIF_4_En | Output Control   | RW   |         |        | 1       |
| Bit 3  | 25/26 | DIF_3_En | Output Control   | RW   |         |        | 1       |
| Bit 2  | 23/24 | DIF_2_En | Output Control   | RW   |         |        | 1       |
| Bit 1  | 19/20 | DIF_1_En | Output Control   | RW   |         |        | 1       |
| Bit 0  | 17/18 | DIF_0_En | Output Control   | RW   |         |        | 1       |

**SMBusTable: Output Control Register**

| Byte 2 | Pin # | Name      | Control Function | Type | 0       | 1      | Default |
|--------|-------|-----------|------------------|------|---------|--------|---------|
| Bit 7  | 62/61 | DIF_15_En | Output Control   | RW   | Low/Low | Enable | 1       |
| Bit 6  | 60/59 | DIF_14_En | Output Control   | RW   |         |        | 1       |
| Bit 5  | 56/55 | DIF_13_En | Output Control   | RW   |         |        | 1       |
| Bit 4  | 54/53 | DIF_12_En | Output Control   | RW   |         |        | 1       |
| Bit 3  | 50/49 | DIF_11_En | Output Control   | RW   |         |        | 1       |
| Bit 2  | 48/47 | DIF_10_En | Output Control   | RW   |         |        | 1       |
| Bit 1  | 44/43 | DIF_9_En  | Output Control   | RW   |         |        | 1       |
| Bit 0  | 42/41 | DIF_8_En  | Output Control   | RW   |         |        | 1       |

**SMBusTable: PLL SW Override Control Register**

| Byte 3 | Pin # | Name       | Control Function             | Type | 0                                     | 1             | Default |
|--------|-------|------------|------------------------------|------|---------------------------------------|---------------|---------|
| Bit 7  |       | Reserved   |                              |      |                                       |               | 0       |
| Bit 6  |       | Reserved   |                              |      |                                       |               | 0       |
| Bit 5  |       | Reserved   |                              |      |                                       |               | 0       |
| Bit 4  |       | Reserved   |                              |      |                                       |               | 0       |
| Bit 3  |       | PLL_SW_EN  | Enable S/W control of PLL BW | RW   | HW Latch                              | SMBus Control | 0       |
| Bit 2  |       | PLL Mode 1 | PLL Operating Mode 1         | RW   | See PLL Operating Mode Readback Table |               | 1       |
| Bit 1  |       | PLL Mode 0 | PLL Operating Mode 1         | RW   | See PLL Operating Mode Readback Table |               | 1       |
| Bit 0  |       | Reserved   |                              |      |                                       |               | 0       |

**Note:** Setting bit 3 to '1' allows the user to override the Latch value from pin 4 via use of bits 2 and 1. Use the values from the PLL Operating Mode Readback Table. Note that Byte 0, Bits 7:6 will keep the value originally latched on pin 4. A warm reset of the system will have to be accomplished if the user changes these bits.

SMBusTable: Reserved Register

| Byte 4 | Pin # | Name | Control Function | Type | 0 | 1 | Default |
|--------|-------|------|------------------|------|---|---|---------|
| Bit 7  |       |      | Reserved         |      |   |   | 0       |
| Bit 6  |       |      | Reserved         |      |   |   | 0       |
| Bit 5  |       |      | Reserved         |      |   |   | 0       |
| Bit 4  |       |      | Reserved         |      |   |   | 0       |
| Bit 3  |       |      | Reserved         |      |   |   | 0       |
| Bit 2  |       |      | Reserved         |      |   |   | 0       |
| Bit 1  |       |      | Reserved         |      |   |   | 0       |
| Bit 0  |       |      | Reserved         |      |   |   | 0       |

SMBusTable: Vendor &amp; Revision ID Register

| Byte 5 | Pin # | Name | Control Function | Type | 0                                    | 1 | Default |
|--------|-------|------|------------------|------|--------------------------------------|---|---------|
| Bit 7  | -     | RID3 | REVISION ID      | R    | A rev = 0000<br>B rev = 0001<br>etc. |   | X       |
| Bit 6  | -     | RID2 |                  | R    |                                      | X |         |
| Bit 5  | -     | RID1 |                  | R    |                                      | X |         |
| Bit 4  | -     | RID0 |                  | R    |                                      | X |         |
| Bit 3  | -     | VID3 | VENDOR ID        | R    | -                                    | - | 0       |
| Bit 2  | -     | VID2 |                  | R    | -                                    | - | 0       |
| Bit 1  | -     | VID1 |                  | R    | -                                    | - | 0       |
| Bit 0  | -     | VID0 |                  | R    | -                                    | - | 1       |

SMBusTable: DEVICE ID

| Byte 6 | Pin # | Name | Control Function  | Type | 0  | 1 | Default |
|--------|-------|------|-------------------|------|--|---|---------|
| Bit 7  | -     |      | Device ID 7 (MSB) | R    | 1950 is 195 Decimal<br>or C3 Hex<br>1550 is 155 Decimal<br>or 9B Hex |   | 1       |
| Bit 6  | -     |      | Device ID 6       | R    |  | 1 |         |
| Bit 5  | -     |      | Device ID 5       | R    |  | 0 |         |
| Bit 4  | -     |      | Device ID 4       | R    |  | 0 |         |
| Bit 3  | -     |      | Device ID 3       | R    |  | 0 |         |
| Bit 2  | -     |      | Device ID 2       | R    |  | 0 |         |
| Bit 1  | -     |      | Device ID 1       | R    |  | 1 |         |
| Bit 0  | -     |      | Device ID 0       | R    |  | 1 |         |

SMBusTable: Byte Count Register

| Byte 7 | Pin # | Name | Control Function  | Type | 0   | 1 | Default |
|--------|-------|------|---|------|---|---|---------|
| Bit 7  |       |      | Reserved  |      |   |   | 0       |
| Bit 6  |       |      | Reserved  |      |   |   | 0       |
| Bit 5  |       |      | Reserved  |      |   |   | 0       |
| Bit 4  | -     | BC4  | Writing to this register configures how many bytes will be read back. | RW   | Default value is 8 hex, so 9 bytes (0 to 8) will be read back by default. |   | 0       |
| Bit 3  | -     | BC3  |   | RW   |   | 1 |         |
| Bit 2  | -     | BC2  |   | RW   |   | 0 |         |
| Bit 1  | -     | BC1  |   | RW   |   | 0 |         |
| Bit 0  | -     | BC0  |   | RW   |   | 0 |         |

SMBusTable: Reserved Register

| Byte 8 | Pin # | Name | Control Function | Type | 0 | 1 | Default |
|--------|-------|------|------------------|------|---|---|---------|
| Bit 7  |       |      | Reserved         |      |   |   | 0       |
| Bit 6  |       |      | Reserved         |      |   |   | 0       |
| Bit 5  |       |      | Reserved         |      |   |   | 0       |
| Bit 4  |       |      | Reserved         |      |   |   | 0       |
| Bit 3  |       |      | Reserved         |      |   |   | 0       |
| Bit 2  |       |      | Reserved         |      |   |   | 0       |
| Bit 1  |       |      | Reserved         |      |   |   | 0       |
| Bit 0  |       |      | Reserved         |      |   |   | 0       |

## Alternate Terminations

The 9ZXL1950 can be terminated to other logic families. See [“AN-891 Driving LVPECL, LVDS, and CML Logic with IDT's “Universal” Low-Power HCSL Outputs”](#) for details.

## Marking Diagram

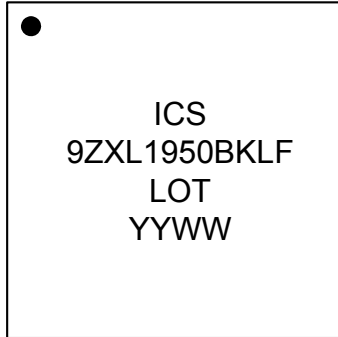

### Notes:

1. “LOT” denotes the lot number.
2. “YYWW” is the last two digits of the year and week that the part was assembled.
3. “LF” denotes RoHS compliant package.
4. Bottom marking: country of origin if not USA.

Package Outline and Dimensions (NLG72)



| DATE    |     | REVISIONS                         |  |        |
|---------|-----|-----------------------------------|--|--------|
| CREATED | REV | DESCRIPTION                       |  | AUTHOR |
| 2/2/16  | 00  | INITIAL RELEASE.                  |  | JH     |
| 1/11/17 | 01  | CORRECT <i>eee</i> TOLERANCE.     |  | JH     |
| 5/8/17  | 02  | CHANGE PACKAGE CODE QFN to VFQFPN |  | JH     |

NOTE: REFER TO DCP FOR OFFICIAL RELEASE DATE

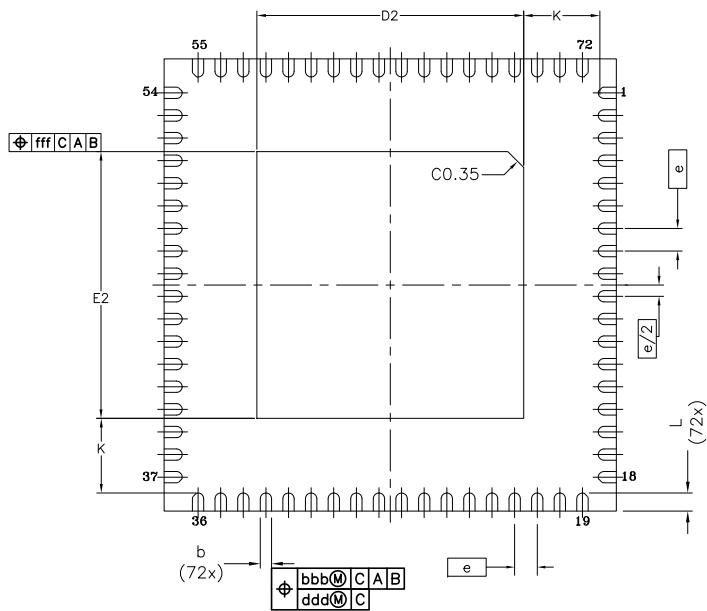
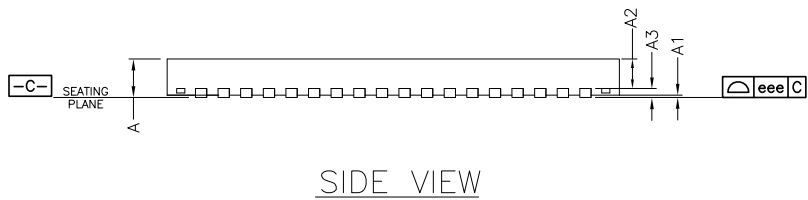
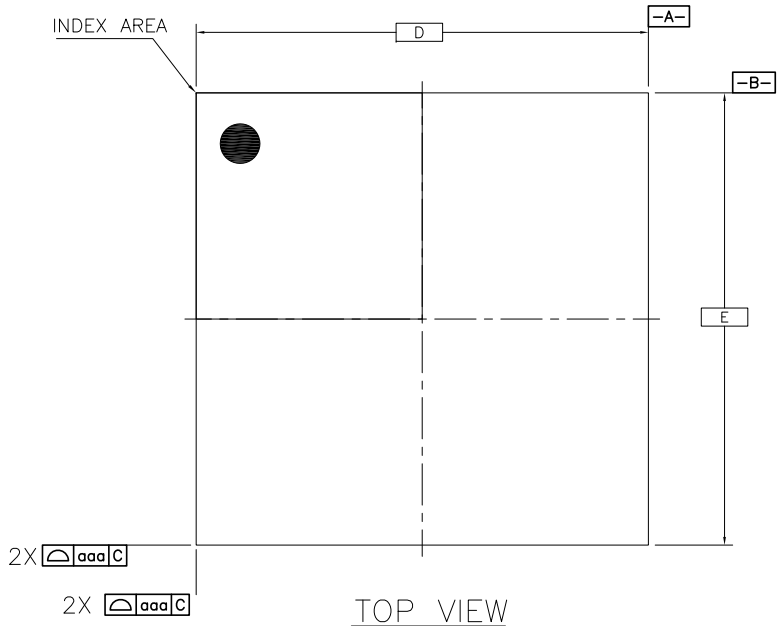

NOTES:

1. ALL DIMENSIONING AND TOLERANCING CONFORM TO ANSI Y14.5M-1994
2. ALL DIMENSIONS ARE IN MILLIMETERS.
3. INDEX AREA (PIN1 IDENTIFIER)

TOLERANCES UNLESS SPECIFIED  
 DECIMAL ANGULAR  
 X±  
 XX±  
 XXX±



6024 Silver Creek Valley Road  
 San Jose, CA 95138  
 PHONE: (408) 284-8200  
 FAX: (408) 284-8591

TITLE NL/NLG72 PACKAGE OUTLINE  
 10.0 x 10.0 mm BODY, EPAD 5.9mm SQ.  
 0.50 mm Pitch VFQFPN (SAWN)

|      |             |     |
|------|-------------|-----|
| SIZE | DRAWING No. | REV |
| C    | PSC-4208-01 | 02  |

DO NOT SCALE DRAWING SHEET 1 OF 3

| DATE    |     | REVISIONS                         |  |        |
|---------|-----|-----------------------------------|--|--------|
| CREATED | REV | DESCRIPTION                       |  | AUTHOR |
| 2/2/16  | 00  | INITIAL RELEASE.                  |  | JH     |
| 1/11/17 | 01  | CORRECT eee TOLERANCE.            |  | JH     |
| 5/8/17  | 02  | CHANGE PACKAGE CODE QFN to VFQFPN |  | JH     |

NOTE: REFER TO DCP FOR OFFICIAL RELEASE DATE

| SYMBOL     | DIMENSIONS |      |      |
|------------|------------|------|------|
|            | MIN.       | NOM. | MAX. |
| D2         | 5.80       | 5.90 | 6.00 |
| F2         | 5.80       | 5.90 | 6.00 |
| A2         | 0.00       | 0.65 | 1.00 |
| L          | 0.30       | 0.40 | 0.50 |
| A          | 0.80       | 0.90 | 1.00 |
| A1         | 0.00       | 0.02 | 0.05 |
| A3         | 0.20 ref.  |      |      |
| b          | 0.18       | 0.25 | 0.30 |
| Ⓢ          | 0.50 BSC   |      |      |
| D          | 10.00 BSC  |      |      |
| E          | 10.00 BSC  |      |      |
| K          | 1.65 ref.  |      |      |
| TOLERANCES |            |      |      |
| aaa        | 0.15       |      |      |
| bbb        | 0.10       |      |      |
| ccc        | 0.05       |      |      |
| eee        | 0.08       |      |      |
| fff        | 0.10       |      |      |

|   |   |              |
|---|---|--------------|
| TOLERANCES<br>UNLESS SPECIFIED<br>DECIMAL    ANGULAR<br>X±<br>XX±<br>XXX± | 6024 Silver Creek Valley Road<br>San Jose, CA 95138<br>PHONE: (408) 284-8200<br>FAX: (408) 284-8591<br><a href="http://www.IDT.com">www.IDT.com</a> |              |
|   | TITLE NL/NLG72 PACKAGE OUTLINE<br>10.0 x 10.0 mm BODY, EPAD 5.9mm SQ.<br>0.50 mm Pitch VFQFPN (SAWN)  |              |
| SIZE  | DRAWING No.   | REV          |
| C   | PSC-4208-01   | 02           |
| DO NOT SCALE DRAWING  |   | SHEET 2 OF 3 |

| DATE    |     | REVISIONS                         |  |        |
|---------|-----|-----------------------------------|--|--------|
| CREATED | REV | DESCRIPTION                       |  | AUTHOR |
| 2/2/16  | 00  | INITIAL RELEASE.                  |  | JH     |
| 1/11/17 | 01  | CORRECT eee TOLERANCE.            |  | JH     |
| 5/8/17  | 02  | CHANGE PACKAGE CODE QFN to VFQFPN |  | JH     |

NOTE: REFER TO DCP FOR OFFICIAL RELEASE DATE

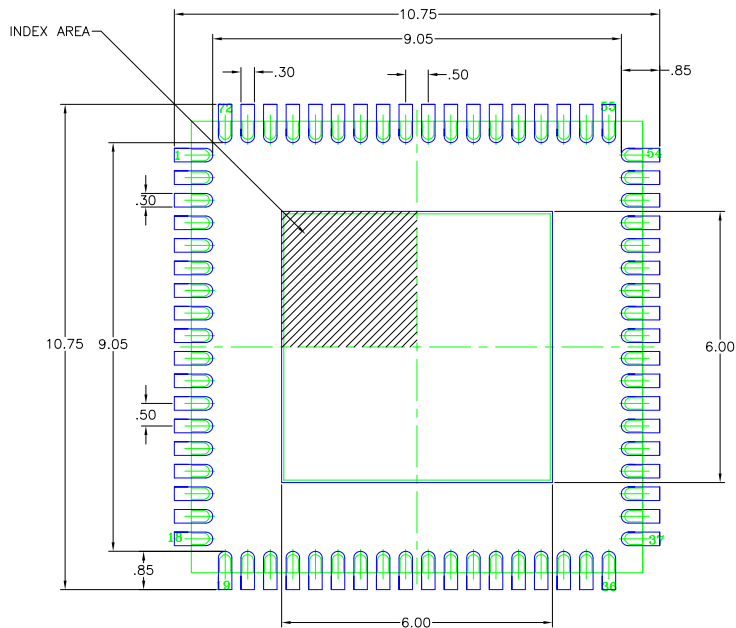

RECOMMENDED LAND PATTERN DIMENSION

NOTES:

1. ALL DIMENSIONS ARE IN mm. ANGLES IN DEGREES.
2. TOP DOWN VIEW. AS VIEWED ON PCB.
3. COMPONENT OUTLINE SHOWS FOR REFERENCE IN GREEN.
4. LAND PATTERN IN BLUE. NSMD PATTERN ASSUMED.
5. LAND PATTERN RECOMMENDATION PER IPC-7351B GENERIC REQUIREMENT FOR SURFACE MOUNT DESIGN AND LAND PATTERN.

|                             |         |  |  |              |
|-----------------------------|---------|--|--|--------------|
| TOLERANCES UNLESS SPECIFIED |         |  <b>IDT™</b><br>www.IDT.com | 6024 Silver Creek Valley Road<br>San Jose, CA 95138<br>PHONE: (408) 284-8200<br>FAX: (408) 284-8591  |              |
| DECIMAL                     | ANGULAR |  | TITLE NL/NLG72 PACKAGE OUTLINE<br>10.0 x 10.0 mm BODY, EPAD 5.9mm SQ.<br>0.50 mm Pitch VFQFPN (SAWN) |              |
| X±                          |         | SIZE   | DRAWING No.  | REV          |
| XX±                         |         | C  | PSC-4208-01  | 02           |
| XXX±                        |         | DO NOT SCALE DRAWING   |  | SHEET 3 OF 3 |



## Ordering Information

| Part / Order Number | Shipping Package | Package       | Temperature |
|---------------------|------------------|---------------|-------------|
| 9ZX1950BKLF         | Trays            | 72-pin VFQFPN | 0 to +70°C  |
| 9ZX1950BKLF1        | Tape and Reel    | 72-pin VFQFPN | 0 to +70°C  |

“LF” suffix to the part number are the Pb-Free configuration and are RoHS compliant.

“B” is the device revision designator (will not correlate with the datasheet revision).

## Revision History

| Rev. | Issuer | Issue Date | Description   | Page #                             |
|------|--------|------------|---|------------------------------------|
| A    | RDW    | 3/11/2014  | Moved to final.   |                                    |
| B    | RDW    | 3/7/2015   | 1. Cleaned up output pin names to be DIFxx instead of DIF_xx<br>2. Updated electrical tables to new format<br>3. Updated ordering info to B rev along with Rev ID.<br>4. Updated termination schemes for driving LVDS.<br>5. Minor cleanup/reformatting of DS, including front page text.   | Various                            |
| C    | RDW    | 6/16/2015  | Added landing pattern from POD  | 17                                 |
| D    | RDW    | 7/30/2015  | 1. Tightened O2O spec from 75 to 50ps<br>2. Added epad (pin 73) to power connections table<br>3. Updated pin 73 pin name from "GND" to "epad"<br>4. Clarified SMBus operating frequency by removing the word "Maximum" and updated the symbol from fMINSMB to fSMB<br>5. Tightened duty cycle distortion and additive cycle to cycle jitter specs<br>6. Updated Rs from 7 to 7.5 ohms in Test Loads Table<br>7. Replaced LVDS termination info with reference to AN891. | 1,8<br>2<br>4<br>6<br>8<br>9<br>13 |
| E    | RDW    | 11/20/2015 | 1. Updated QPI references to QPI/UPI<br>2. Updated DIF_IN table to match PCI SIG specification, no silicon change   | 1,5                                |
| F    | RDW    | 5/11/2017  | Updated package outline drawings to latest version.   | 14-16                              |



**Corporate Headquarters**  
6024 Silver Creek Valley Road  
San Jose, CA 95138 USA  
[www.IDT.com](http://www.IDT.com)

**Sales**  
1-800-345-7015 or 408-284-8200  
Fax: 408-284-2775  
[www.IDT.com/go/sales](http://www.IDT.com/go/sales)

**Tech Support**  
[www.idt.com/go/support](http://www.idt.com/go/support)

DISCLAIMER Integrated Device Technology, Inc. (IDT) and its affiliated companies (herein referred to as "IDT") reserve the right to modify the products.

and/or specifications described herein at any time, without notice, at IDT's sole discretion. Performance specifications and operating parameters of the described products are determined in an independent state and are not guaranteed to perform the same way when installed in customer products. The information contained herein is provided without representation or warranty of any kind, whether express or implied, including, but not limited to, the suitability of IDT's products for any particular purpose, an implied warranty of merchantability, or non-infringement of the intellectual property rights of others. This document is presented only as a guide and does not convey any license under intellectual property rights of IDT or any third parties.

IDT's products are not intended for use in applications involving extreme environmental conditions or in life support systems or similar devices where the failure or malfunction of an IDT product can be reasonably expected to significantly affect the health or safety of users. Anyone using an IDT product in such a manner does so at their own risk, absent an express, written agreement by IDT.

Integrated Device Technology, IDT and the IDT logo are trademarks or registered trademarks of IDT and its subsidiaries in the United States and other countries. Other trademarks used herein are the property of IDT or their respective third party owners. For datasheet type definitions and a glossary of common terms, visit [www.idt.com/go/glossary](http://www.idt.com/go/glossary). Integrated Device Technology, Inc.. All rights reserved.

Компания «Life Electronics» занимается поставками электронных компонентов импортного и отечественного производства от производителей и со складов крупных дистрибьюторов Европы, Америки и Азии.

С конца 2013 года компания активно расширяет линейку поставок компонентов по направлению коаксиальный кабель, кварцевые генераторы и конденсаторы (керамические, пленочные, электролитические), за счёт заключения дистрибьюторских договоров

Мы предлагаем:

- Конкурентоспособные цены и скидки постоянным клиентам.
- Специальные условия для постоянных клиентов.
- Подбор аналогов.
- Поставку компонентов в любых объемах, удовлетворяющих вашим потребностям.
- Приемлемые сроки поставки, возможна ускоренная поставка.
- Доставку товара в любую точку России и стран СНГ.
- Комплексную поставку.
- Работу по проектам и поставку образцов.
- Формирование склада под заказчика.
- Сертификаты соответствия на поставляемую продукцию (по желанию клиента).
- Тестирование поставляемой продукции.
- Поставку компонентов, требующих военную и космическую приемку.
- Входной контроль качества.
- Наличие сертификата ISO.

В составе нашей компании организован Конструкторский отдел, призванный помогать разработчикам, и инженерам.

Конструкторский отдел помогает осуществить:

- Регистрацию проекта у производителя компонентов.
- Техническую поддержку проекта.
- Защиту от снятия компонента с производства.
- Оценку стоимости проекта по компонентам.
- Изготовление тестовой платы монтаж и пусконаладочные работы.



Тел: +7 (812) 336 43 04 (многоканальный)  
Email: org@lifeelectronics.ru