

### 2920L Series

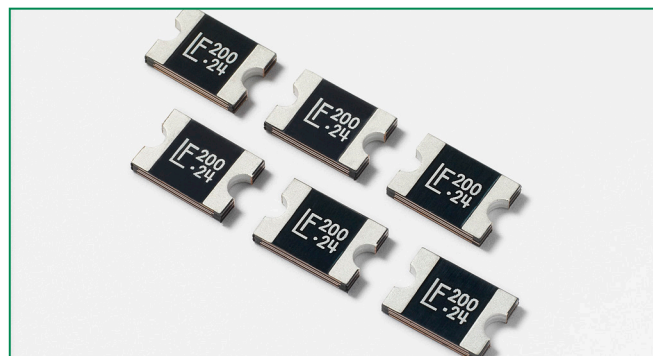

#### Description

The 2920L Series PTC provides surface mount overcurrent protection for medium voltage ( $\leq 60V$ ) applications where resettable protection is desired.



#### Features

- RoHS compliant, lead-free and halogen-free
- High voltage
- Fast response to fault currents
- Low-profile



#### Applications

- IEE1394 port protection
- Powered ethernet port protection (IEEE 802.3 af)
- Automotive electronic control module protection
- Low voltage telecom equipment protection

#### Agency Approvals

AGENCY	AGENCY FILE NUMBER
	E183209
	R50119118

#### Electrical Characteristics

Part Number	Marking	$I_{hold}$ (A)	$I_{trip}$ (A)	$V_{max}$ (Vdc)	$I_{max}$ (A)	$P_d$ typ. (W)	Maximum Time To Trip		Resistance		Agency Approvals	
							Current (A)	Time (Sec.)	$R_{min}$ ( $\Omega$ )	$R_{1max}$ ( $\Omega$ )		
2920L030	LF030	0.30	0.60	60	10	1.50	1.50	3.00	1.200	4.800	X	X
2920L050	LF050	0.50	1.00	60	10	1.50	2.50	4.00	0.350	1.400	X	X
2920L075	LF075	0.75	1.50	30	40	1.50	8.00	0.30	0.350	1.000	X	X
2920L075/60	LF075-60	0.75	1.50	60	10	1.50	8.00	0.30	0.300	0.950	X	X
2920L100	LF100	1.10	2.20	33	40	1.50	8.00	0.50	0.120	0.410	X	X
2920L125	LF125	1.25	2.50	15	40	1.50	8.00	2.00	0.070	0.250	X	X
2920L150	LF150	1.50	3.00	33	40	1.50	8.00	2.00	0.080	0.230	X	X
2920L185	LF185	1.85	3.70	33	40	1.50	8.00	2.50	0.050	0.150	X	X
2920L200	LF200	2.00	4.00	15	40	1.50	8.00	5.00	0.050	0.125	X	X
2920L200/24	LF200-24	2.00	4.00	24	40	1.50	8.00	5.00	0.050	0.125	X	X
2920L250	LF250	2.50	5.00	15	40	1.50	8.00	10.00	0.035	0.085	X	X
2920L260	LF260	2.60	5.00	6	40	1.50	8.00	10.00	0.025	0.075	X	X
2920L260/24	LF260-24	2.60	5.00	24	40	1.50	8.00	10.00	0.025	0.075	X	X
2920L300	LF300	3.00	5.00	6	40	1.50	8.00	20.00	0.015	0.048	X	X
2920L300/15	LF300-15	3.00	5.00	15	40	1.50	8.00	20.00	0.015	0.048	X	X
2920L500/16	LF500-16	5.00	10.00	16	40	2.0	20.00	5.00	0.005	0.025	X	X

$I_{hold}$  = Hold current: maximum current device will pass without tripping in 20°C still air.

$I_{trip}$  = Trip current: minimum current at which the device will trip in 20°C still air.

$V_{max}$  = Maximum voltage device can withstand without damage at rated current ( $I_{max}$ )

$I_{max}$  = Maximum fault current device can withstand without damage at rated voltage ( $V_{max}$ )

$P_d$  = Power dissipated from device when in the tripped state at 20°C still air.

$R_{min}$  = Minimum resistance of device in initial (un-soldered) state.

$R_{typ}$  = Typical resistance of device in initial (un-soldered) state.

$R_{1max}$  = Maximum resistance of device at 20°C measured one hour after tripping or reflow soldering of 260°C for 20 sec.

**Caution:** Operation beyond the specified rating may result in damage and possible arcing and flame.

**Temperature Derating**

Part Number	Ambient Operation Temperature								
	-40°C	-20°C	0°C	20°C	40°C	50°C	60°C	70°C	85°C
2920L030	0.45	0.40	0.35	0.30	0.25	0.23	0.20	0.17	0.14
2920L050	0.76	0.67	0.59	0.50	0.42	0.38	0.33	0.29	0.23
2920L075	1.13	1.01	0.88	0.75	0.62	0.56	0.50	0.44	0.34
2920L075/60	1.13	1.01	0.88	0.75	0.62	0.56	0.50	0.44	0.34
2920L100	1.66	1.47	1.29	1.10	0.91	0.83	0.73	0.64	0.50
2920L125	1.89	1.68	1.46	1.25	1.04	0.94	0.83	0.73	0.56
2920L150	2.27	2.01	1.76	1.50	1.25	1.13	1.00	0.87	0.74
2920L185	2.80	2.47	2.17	1.85	1.54	1.39	1.22	1.07	0.85
2920L200	3.02	2.68	2.34	2.00	1.66	1.50	1.32	1.16	0.90
2920L200/24	3.14	2.77	2.42	2.00	1.73	1.56	1.38	1.20	0.98
2920L250	3.78	3.35	2.93	2.50	2.08	1.88	1.65	1.45	1.13
2920L260	3.64	3.25	2.91	2.60	2.26	2.08	1.95	1.74	1.48
2920L260/24	3.64	3.25	2.91	2.60	2.26	2.08	1.95	1.74	1.48
2920L300	4.53	4.02	3.51	3.00	2.52	2.26	1.99	1.75	1.34
2920L300/15	4.20	3.85	3.44	3.00	2.69	2.50	2.31	2.12	1.83
2920L500/16	6.85	6.25	5.65	5.00	4.25	3.88	3.50	2.80	2.25

Notes: The temperature derating data is only for reference, please contact Littelfuse technical support for detail temperature derating information.

**Average Time Current Curves**

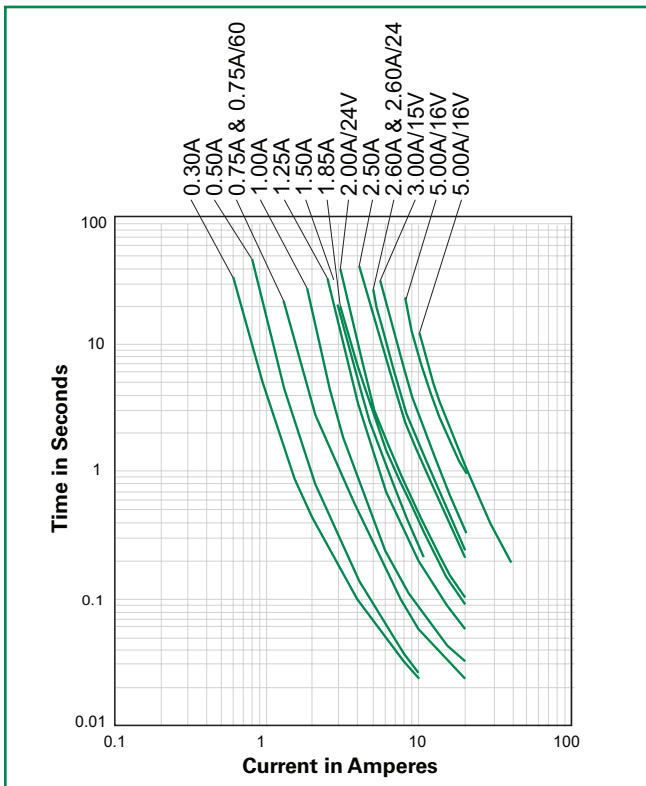

**Temperature Derating Curve**

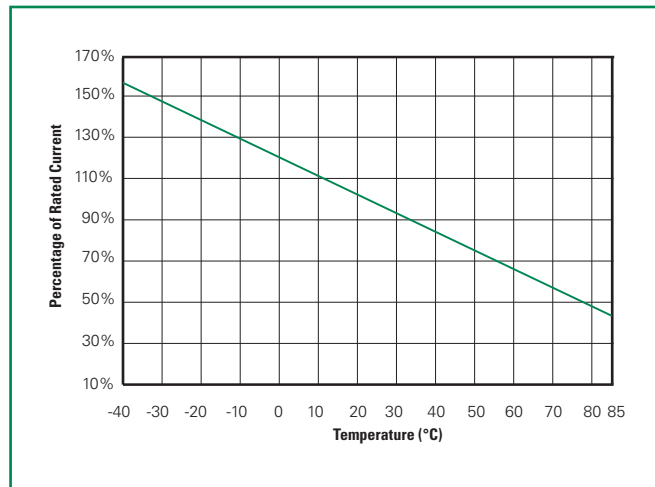

Note:  
Typical Temperature derating curve, refer to table for derating data

The average time current curves and Temperature Derating curve performance is affected by a number of variables, and these curves provided as guidance only. Customer must verify the performance in their application.

### Soldering Parameters

Profile Feature	Pb-Free Assembly	
Average Ramp-Up Rate ( $T_{S(max)}$ to $T_P$ )	3°C/second max	
Pre Heat:	Temperature Min ( $T_{S(min)}$ )	150°C
	Temperature Max ( $T_{S(max)}$ )	200°C
	Time (Min to Max) ( $t_s$ )	60 – 180 secs
Time Maintained Above:	Temperature ( $T_L$ )	217°C
	Temperature ( $t_L$ )	60 – 150 seconds
Peak / Classification Temperature ( $T_P$ )	260 <sup>+0/-5</sup> °C	
Time within 5°C of actual peak Temperature ( $t_p$ )	20 – 40 seconds	
Ramp-down Rate	6°C/second max	
Time 25°C to peak Temperature ( $T_P$ )	8 minutes Max.	

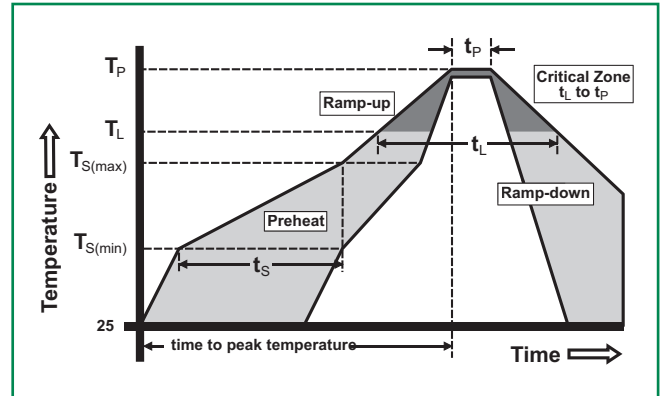

- All temperature refer to topside of the package, measured on the package body surface
- If reflow temperature exceeds the recommended profile, devices may not meet the performance requirements
- Recommended reflow methods: IR, vapor phase oven, hot air oven, N<sub>2</sub> environment for lead
- Recommended maximum paste thickness is 0.25mm (0.010inch)
- Devices can be cleaned using standard industry methods and solvents
- Devices can be reworked using the standard industry practices

### Physical Specifications

<b>Terminal Material</b>	Solder-Plated Copper (Solder Material: Matte Tin(Sn))
<b>Lead Solderability</b>	Meets EIA Specification RS186-9E, ANSI/J-STD-002 Category 3.

### Environmental Specifications

<b>Operating/Storage Temperature</b>	-40°C to +85°C
<b>Maximum Device Surface Temperature in Tripped State</b>	125°C
<b>Passive Aging</b>	+85°C, 1000 hours -/+5% typical resistance change
<b>Humidity Aging</b>	+85°C, 85%, R.H., 1000 hours -/+5% typical resistance change
<b>Thermal Shock</b>	MIL-STD-20 2, Method 107 +85°C/-40°C 20 times -30% typical resistance change
<b>Solvent Resistance</b>	MIL-STD-202, Method 215
<b>Vibration</b>	MIL-STD-883, Method 2007, Condition A
<b>Moisture Sensitivity Level</b>	Level 1, J-STD-020

**Dimensions (mm)**

MARKING CODE VARIES  
WITH AMPERAGE AND VOLTAGE RATING  
(SEE ELECTRICAL CHARACTERISTIC TABLE)  
SHOWN ARE:  
- 1.5A/33V RATING (LEFT)  
- 2.0A/24V RATING (RIGHT)

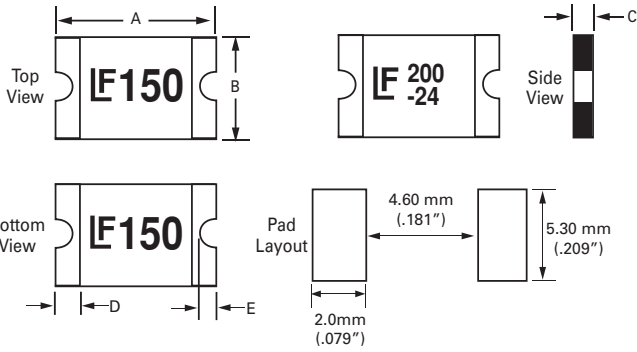

Part Number	A				B				C				D				E			
	Inches		mm		Inches		mm		Inches		mm		Inches		mm		Inches		mm	
	Min	Max	Min	Max	Min	Max	Min	Max	Min	Max	Min	Max	Min	Max	Min	Max	Min	Max	Min	Max
2920L030	0.26	0.31	6.73	7.98	0.19	0.21	4.8	5.44	0.03	0.05	0.75	1.25	0.01	0.1	0.3	2.5	0.01	0.08	0.25	2.0
2920L050	0.26	0.31	6.73	7.98	0.19	0.21	4.8	5.44	0.03	0.05	0.75	1.25	0.01	0.1	0.3	2.5	0.01	0.08	0.25	2.0
2920L075	0.26	0.31	6.73	7.98	0.19	0.21	4.8	5.44	0.03	0.05	0.75	1.25	0.01	0.1	0.3	2.5	0.01	0.08	0.25	2.0
2920L075/60	0.26	0.31	6.73	7.98	0.19	0.21	4.8	5.44	0.05	0.06	1.20	1.80	0.01	0.1	0.3	2.5	0.01	0.08	0.25	2.0
2920L100	0.26	0.31	6.73	7.98	0.19	0.21	4.8	5.44	0.02	0.04	0.55	1.00	0.01	0.1	0.3	2.5	0.01	0.08	0.25	2.0
2920L125	0.26	0.31	6.73	7.98	0.19	0.21	4.8	5.44	0.02	0.04	0.55	1.00	0.01	0.1	0.3	2.5	0.01	0.08	0.25	2.0
2920L150	0.26	0.31	6.73	7.98	0.19	0.21	4.8	5.44	0.03	0.05	0.75	1.25	0.01	0.1	0.3	2.5	0.01	0.08	0.25	2.0
2920L185	0.26	0.31	6.73	7.98	0.19	0.21	4.8	5.44	0.03	0.05	0.75	1.25	0.01	0.1	0.3	2.5	0.01	0.08	0.25	2.0
2920L200	0.26	0.31	6.73	7.98	0.19	0.21	4.8	5.44	0.03	0.05	0.75	1.25	0.01	0.1	0.3	2.5	0.01	0.08	0.25	2.0
2920L200/24	0.26	0.31	6.73	7.98	0.19	0.21	4.8	5.44	0.03	0.05	0.75	1.25	0.01	0.1	0.3	2.5	0.01	0.08	0.25	2.0
2920L250	0.26	0.31	6.73	7.98	0.19	0.21	4.8	5.44	0.03	0.05	0.75	1.25	0.01	0.1	0.3	2.5	0.01	0.08	0.25	2.0
2920L260	0.26	0.31	6.73	7.98	0.19	0.21	4.8	5.44	0.02	0.04	0.55	1.00	0.01	0.1	0.3	2.5	0.01	0.08	0.25	2.0
2920L260/24	0.26	0.31	6.73	7.98	0.19	0.21	4.8	5.44	0.03	0.05	0.75	1.25	0.01	0.1	0.3	2.5	0.01	0.08	0.25	2.0
2920L300	0.26	0.31	6.73	7.98	0.19	0.21	4.8	5.44	0.03	0.05	0.75	1.25	0.01	0.1	0.3	2.5	0.01	0.08	0.25	2.0
2920L300/15	0.26	0.31	6.73	7.98	0.19	0.21	4.8	5.44	0.03	0.05	0.75	1.25	0.01	0.1	0.3	2.5	0.01	0.08	0.25	2.0
2920L500/16	0.26	0.31	6.73	7.98	0.19	0.21	4.80	5.44	0.80	1.60	0.80	1.60	0.01	0.1	0.3	2.5	0.01	0.08	0.25	2.0

### Part Ordering Number System

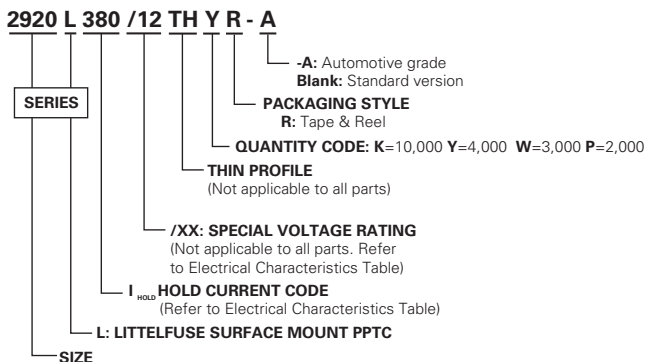

### Packaging

Part Number	Ordering Number	Halogen Free	I <sub>hold</sub> (A)	I <sub>hold</sub> Code	Voltage Option	Packaging Option	Quantity	Quantity & Packaging Codes
2920L030	2920L030DR	Yes	0.30	030		Tape and Reel	1500	DR
2920L050	2920L050DR	Yes	0.50	050		Tape and Reel	1500	DR
2920L075	2920L075DR	Yes	0.75	075		Tape and Reel	1500	DR
2920L075/60	2920L075/60MR	Yes	0.75	075	/60	Tape and Reel	1000	MR
2920L100	2920L100PR	Yes	1.10	100		Tape and Reel	2000	PR
2920L125	2920L125PR	Yes	1.25	125		Tape and Reel	2000	PR
2920L150	2920L150DR	Yes	1.50	150		Tape and Reel	1500	DR
2920L185	2920L185DR	Yes	1.85	185		Tape and Reel	1500	DR
2920L200	2920L200DR	Yes	2.00	200		Tape and Reel	1500	DR
2920L200/24	2920L200/24DR	Yes	2.00	200	/24	Tape and Reel	1500	DR
2920L250	2920L250DR	Yes	2.50	250		Tape and Reel	1500	DR
2920L260/24	2920L260/24DR	Yes	2.60	260	/24	Tape and Reel	1500	DR
2920L260	2920L260PR	Yes	2.60	260		Tape and Reel	2000	PR
2920L300	2920L300DR	Yes	3.00	300		Tape and Reel	1500	DR
2920L300/15	2920L300/15DR	Yes	3.00	300	/15	Tape and Reel	1500	DR
2920L500/16	2920L500/16MR	Yes	5.00	500		Tape and Reel	1,000	MR

**Tape and Reel Specifications**

TAPE SPECIFICATIONS: EIA-481-1 (mm)			
	2920L030, 2920L050 2920L075, 2920L150 2920L185, 2920L200 2920L200/24 2920L250, 2920L300 2920L300/15	2920L100, 2920L125, 2920L260	2920L075/60 2920L500/16
<b>W</b>	16.0+/-0.30	16.0+/-0.30	16.0+/-0.30
<b>F</b>	7.50+/-0.10	7.50+/-0.05	7.50+/-0.10
<b>E<sub>1</sub></b>	1.75+/-0.10	1.75+/-0.10	1.75+/-0.10
<b>D<sub>0</sub></b>	1.55+/-0.05	1.55+/-0.05	1.50+/-0.05
<b>D<sub>1</sub></b>	1.50+/-0.10	1.50+/-0.10	1.50 (min)
<b>P<sub>0</sub></b>	4.00+/-0.10	4.00+/-0.10	4.00+/-0.10
<b>P<sub>1</sub></b>	8.00+/-0.10	8.00+/-0.10	8.00+/-0.10
<b>P<sub>2</sub></b>	2.00+/-0.05	2.00+/-0.05	2.00+/-0.05
<b>A<sub>0</sub></b>	5.74+/-0.10	5.74+/-0.10	5.45+/-0.10
<b>B<sub>0</sub></b>	8.02+/-0.10	8.02+/-0.10	7.80+/-0.10
<b>T</b>	0.30+/-0.10	0.30+/-0.10	0.30+/-0.10
<b>K<sub>0</sub></b>	1.30+/-0.10	0.91+/-0.10	2.00+/-0.10
<i>Leader min.</i>	390	390	390
<i>Trailer min.</i>	160	160	160

REEL DIMENSIONS: EIA-481-1 (mm)	
<b>C</b>	Ø180.0+/-3.0
<b>D</b>	Ø60+/-0.5
<b>H</b>	19.5+/-1.0
<b>W</b>	17+/-0.2

**Tape and Reel Diagram**

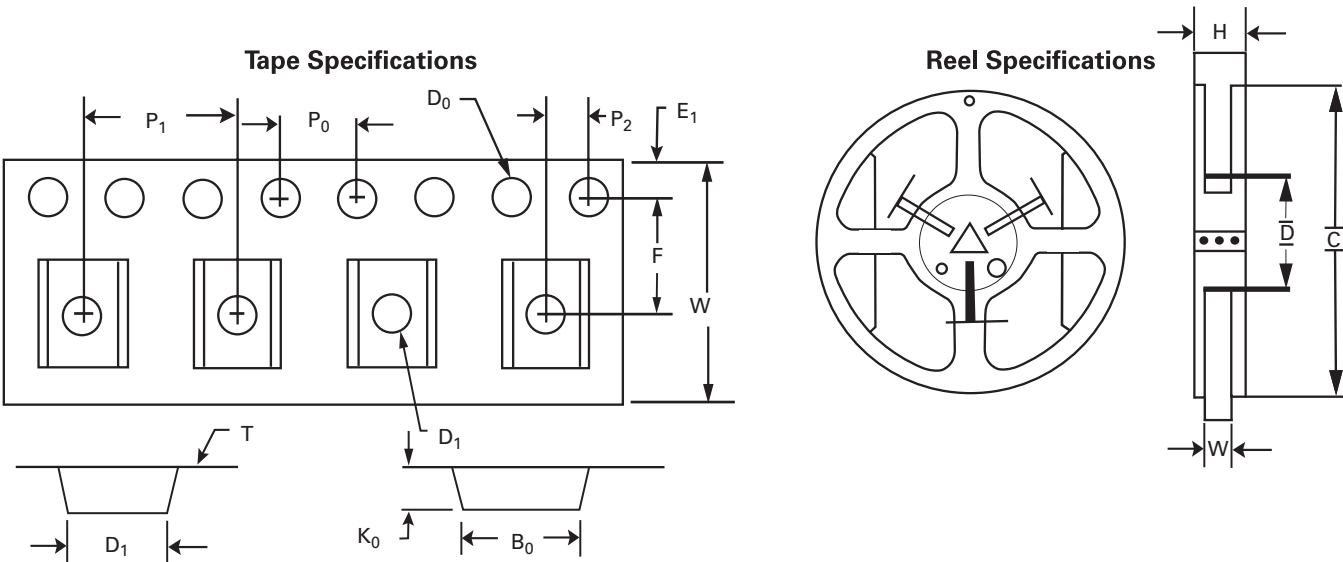

**WARNING**

- Users shall independently assess the suitability of these devices for each of their applications
- Operation of these devices beyond the stated maximum ratings could result in damage to the devices and lead to electrical arcing and/or fire
- These devices are intended to protect against the effects of temporary over-current or over-temperature conditions and are not intended to perform as protective devices where such conditions are expected to be repetitive or prolonged in duration
- Exposure to silicon-based oils, solvents, electrolytes, acids, and similar materials can adversely affect the performance of these PPTC devices
- These devices undergo thermal expansion under fault conditions, and thus shall be provided with adequate space and be protected against mechanical stresses
- Circuits with inductance may generate a voltage (L di/dt) above the rated voltage of the PPTC device.

Компания «Life Electronics» занимается поставками электронных компонентов импортного и отечественного производства от производителей и со складов крупных дистрибьюторов Европы, Америки и Азии.

С конца 2013 года компания активно расширяет линейку поставок компонентов по направлению коаксиальный кабель, кварцевые генераторы и конденсаторы (керамические, пленочные, электролитические), за счёт заключения дистрибьюторских договоров

Мы предлагаем:

- Конкурентоспособные цены и скидки постоянным клиентам.
- Специальные условия для постоянных клиентов.
- Подбор аналогов.
- Поставку компонентов в любых объемах, удовлетворяющих вашим потребностям.
- Приемлемые сроки поставки, возможна ускоренная поставка.
- Доставку товара в любую точку России и стран СНГ.
- Комплексную поставку.
- Работу по проектам и поставку образцов.
- Формирование склада под заказчика.
- Сертификаты соответствия на поставляемую продукцию (по желанию клиента).
- Тестирование поставляемой продукции.
- Поставку компонентов, требующих военную и космическую приемку.
- Входной контроль качества.
- Наличие сертификата ISO.

В составе нашей компании организован Конструкторский отдел, призванный помогать разработчикам, и инженерам.

Конструкторский отдел помогает осуществить:

- Регистрацию проекта у производителя компонентов.
- Техническую поддержку проекта.
- Защиту от снятия компонента с производства.
- Оценку стоимости проекта по компонентам.
- Изготовление тестовой платы монтаж и пусконаладочные работы.



Тел: +7 (812) 336 43 04 (многоканальный)  
Email: [org@lifeelectronics.ru](mailto:org@lifeelectronics.ru)