

Complementary power Darlingtons

Features

- Low collector-emitter saturation voltage
- Integrated antiparallel collector-emitter diode

Applications

- General purpose linear and switching

Description

The devices are manufactured in planar technology with “base island” layout and monolithic Darlingtons configuration. The resulting transistors show exceptional high gain performance coupled with very low saturation voltage.

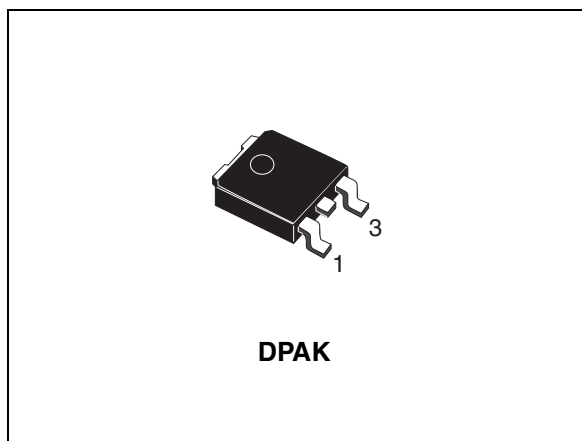

Figure 1. Internal schematic diagrams

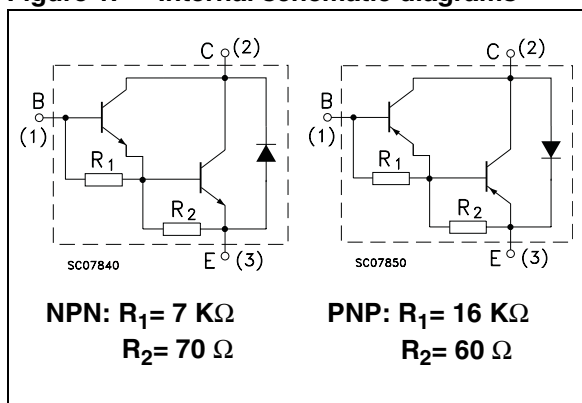

Table 1. Device summary

Order codes	Marking	Polarity	Package	Packaging
MJD122T4	MJD122	NPN	DPAK	Tape and reel
MJD127T4	MJD127	PNP		

Content

1	Electrical ratings	3
2	Electrical characteristics	4
	2.1 Electrical characteristics (curves)	5
3	Test circuits	8
4	Package mechanical data	9
5	Revision history	11

1 Electrical ratings

Table 2. Absolute maximum ratings

Symbol	Parameter	Value	Unit
V_{CBO}	Collector-base voltage ($I_E = 0$)	100	V
V_{CEO}	Collector-emitter voltage ($I_B = 0$)	100	V
V_{EBO}	Emitter-base voltage ($I_C = 0$)	5	V
I_C	Collector current	8	A
I_{CM}	Collector peak current	16	A
I_B	Base current	0.12	A
P_{TOT}	Total dissipation at $T_{case} = 25^\circ\text{C}$	20	W
T_{stg}	Storage temperature	-65 to 150	$^\circ\text{C}$
T_J	Max. operating junction temperature	150	$^\circ\text{C}$

Note: For PNP types voltage and current values are negative.

Table 3. Thermal data

Symbol	Parameter	Value	Unit
R_{thj-c}	Thermal resistance junction-case max.	6.25	$^\circ\text{C}/\text{W}$

2 Electrical characteristics

($T_{\text{case}} = 25\text{ °C}$; unless otherwise specified)

Table 4. Electrical characteristics

Symbol	Parameter	Test conditions	Min.	Typ.	Max.	Unit
I_{CBO}	Collector cut-off current ($I_{\text{E}} = 0$)	$V_{\text{CB}} = 100\text{ V}$		-	10	μA
I_{CEO}	Collector cut-off current ($I_{\text{B}} = 0$)	$V_{\text{CE}} = 50\text{ V}$		-	10	μA
I_{EBO}	Emitter cut-off current ($I_{\text{C}} = 0$)	$V_{\text{EB}} = 5\text{ V}$		-	2	mA
$V_{\text{CEO(sus)}}^{(1)}$	Collector-emitter sustaining voltage ($I_{\text{B}} = 0$)	$I_{\text{C}} = 30\text{ mA}$	100	-		V
$V_{\text{CE(sat)}}^{(1)}$	Collector-emitter saturation voltage	$I_{\text{C}} = 4\text{ A}$ $I_{\text{B}} = 16\text{ mA}$		-	2	V
		$I_{\text{C}} = 8\text{ A}$ $I_{\text{B}} = 80\text{ mA}$			4	V
$V_{\text{BE(sat)}}^{(1)}$	Base-emitter saturation voltage	$I_{\text{C}} = 8\text{ A}$ $I_{\text{B}} = 80\text{ mA}$		-	4.5	V
$V_{\text{BE(on)}}^{(1)}$	Base-emitter on voltage	$I_{\text{C}} = 4\text{ A}$ $V_{\text{CE}} = 4\text{ V}$		-	2.8	V
$h_{\text{FE}}^{(1)}$	DC current gain	$I_{\text{C}} = 4\text{ A}$ $V_{\text{CE}} = 4\text{ V}$	1000	-	12000	
		$I_{\text{C}} = 8\text{ A}$ $V_{\text{CE}} = 4\text{ V}$	100			

1. Pulsed duration = 300 μs , duty cycle $\leq 1.5\%$

Note: For PNP types voltage and current values are negative.

2.1 Electrical characteristics (curves)

Figure 2. Safe operating area

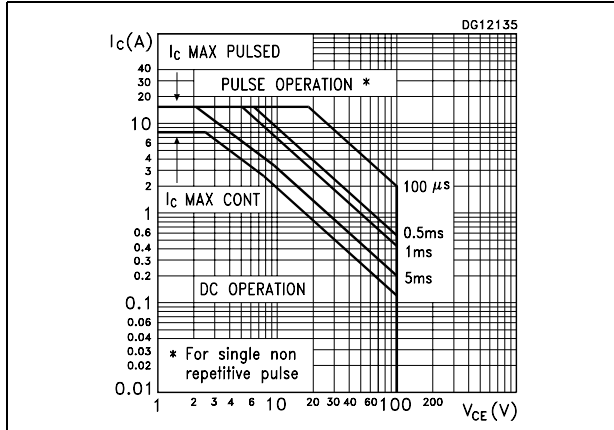

Figure 3. Derating curve

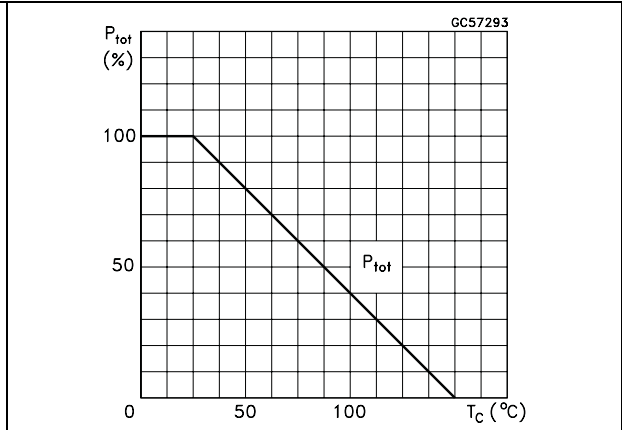

Figure 4. DC current gain for NPN type

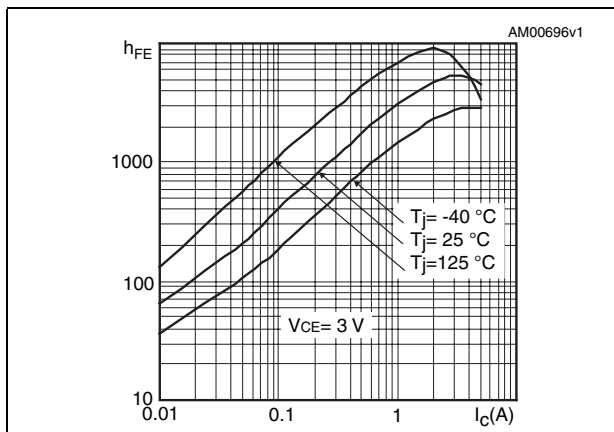

Figure 5. DC current gain for PNP type

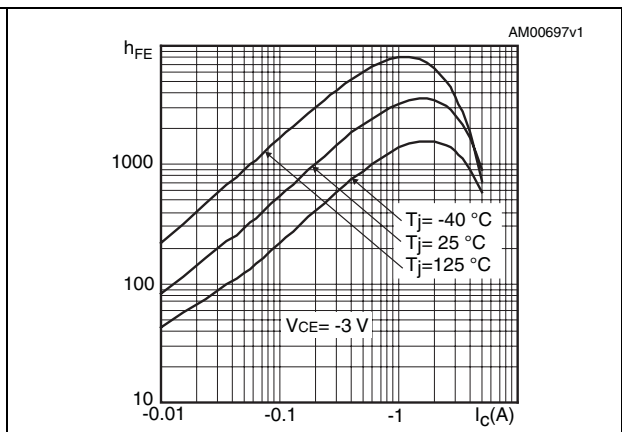

Figure 6. Collector-emitter saturation voltage for NPN type

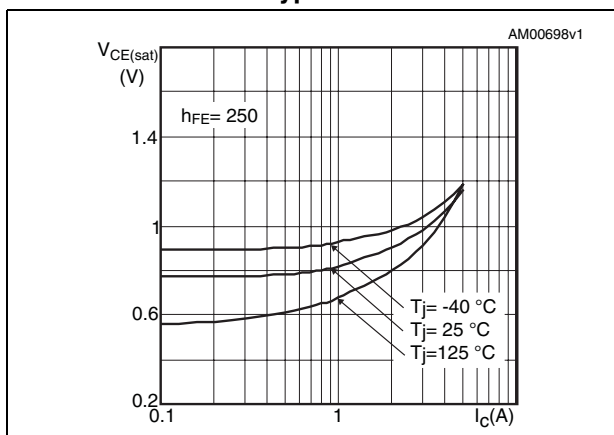

Figure 7. Collector-emitter saturation voltage for PNP type

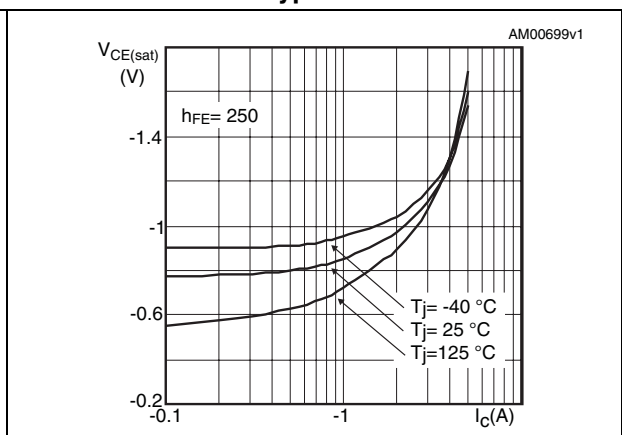

Figure 8. Base-emitter saturation voltage for NPN type

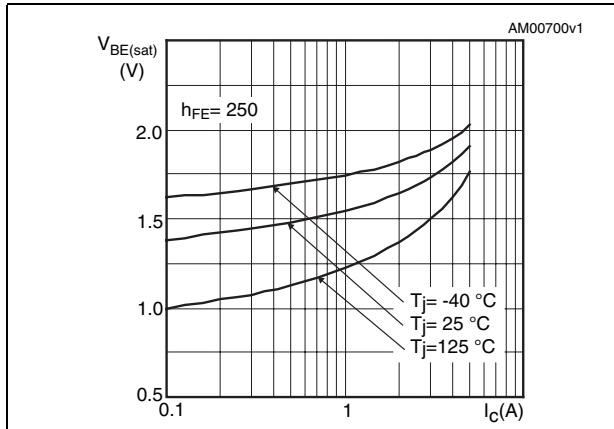

Figure 9. Base-emitter saturation voltage for PNP type

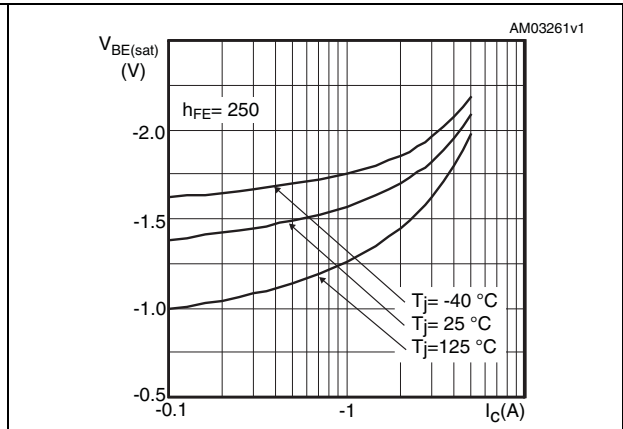

Figure 10. Base-emitter on voltage for NPN type

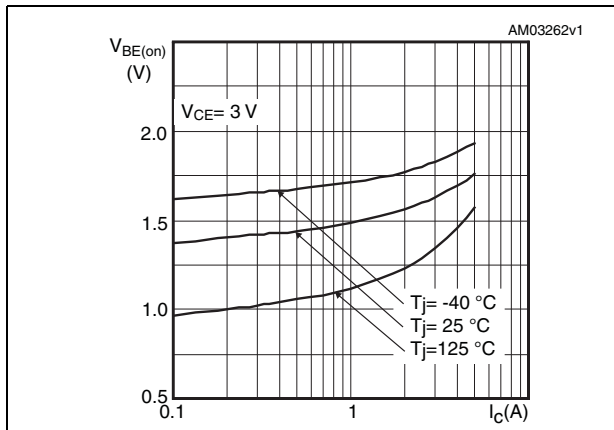

Figure 11. Base-emitter on voltage for PNP type

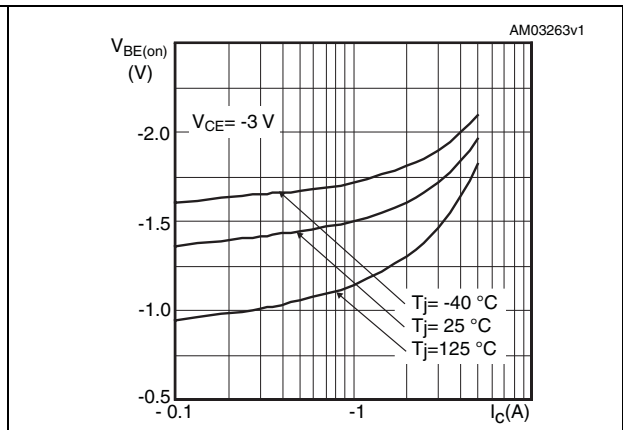

Figure 12. Resistive load switching times for NPN type (on)

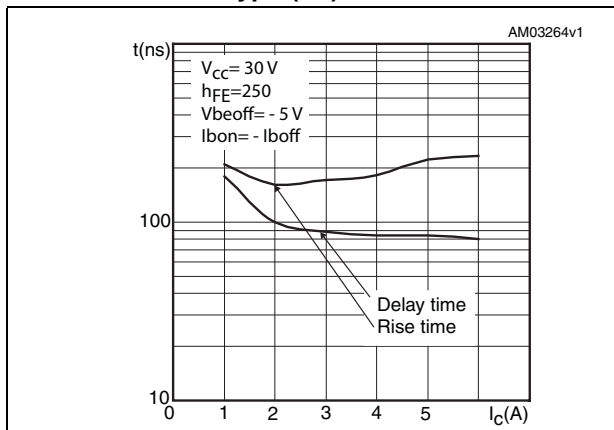

Figure 13. Resistive load switching times for PNP type (on)

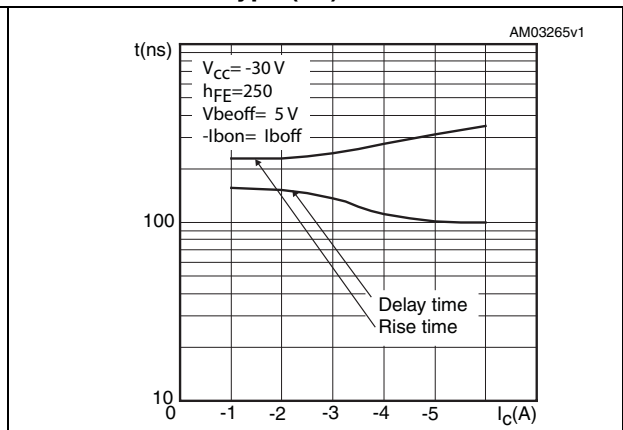

Figure 14. Resistive load switching times for NPN type (off)

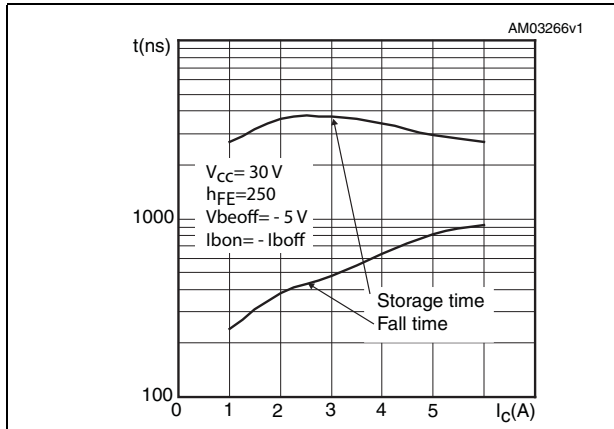

Figure 15. Resistive load switching times for PNP type (off)

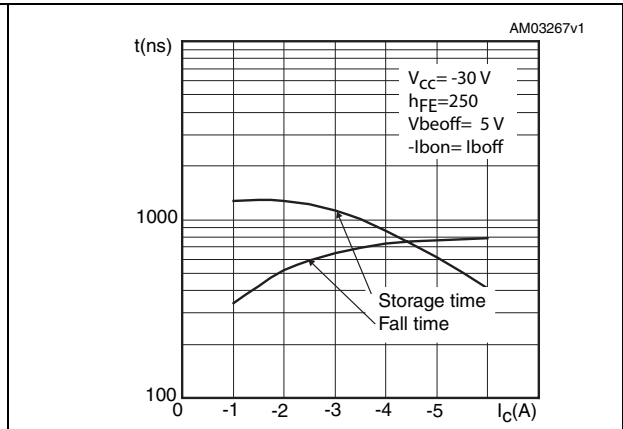

Figure 16. Capacitances for NPN type

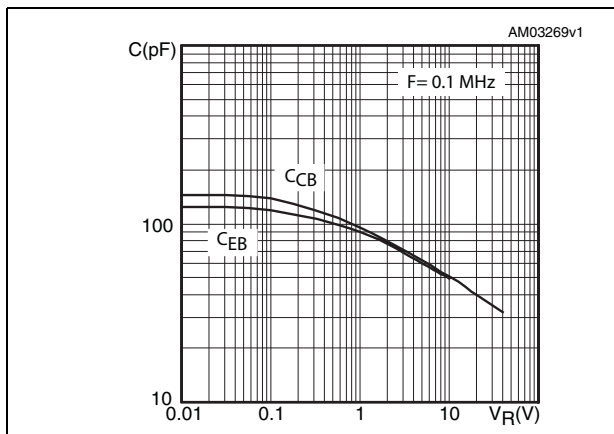
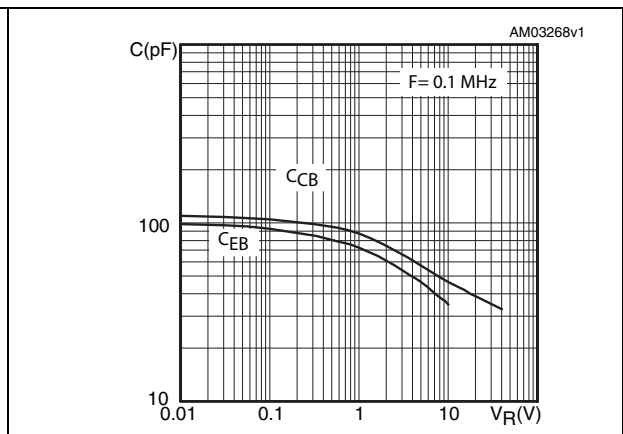
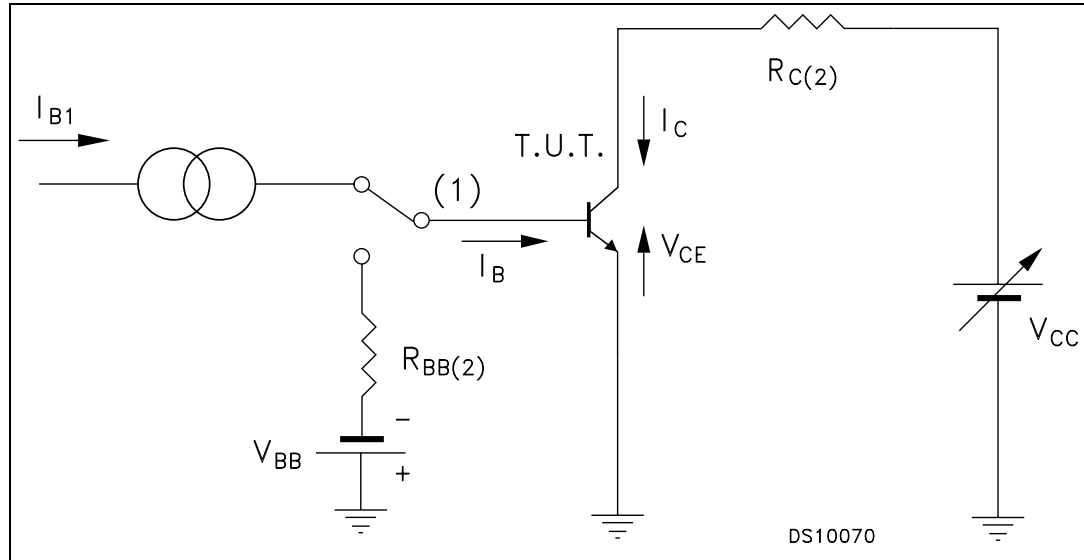

Figure 17. Capacitances for PNP type



3 Test circuits

Figure 18. Resistive load switching for NPN type



- 1. Fast electronic switch
- 2. Non-inductive resistor

Figure 19. Resistive load switching for PNP type

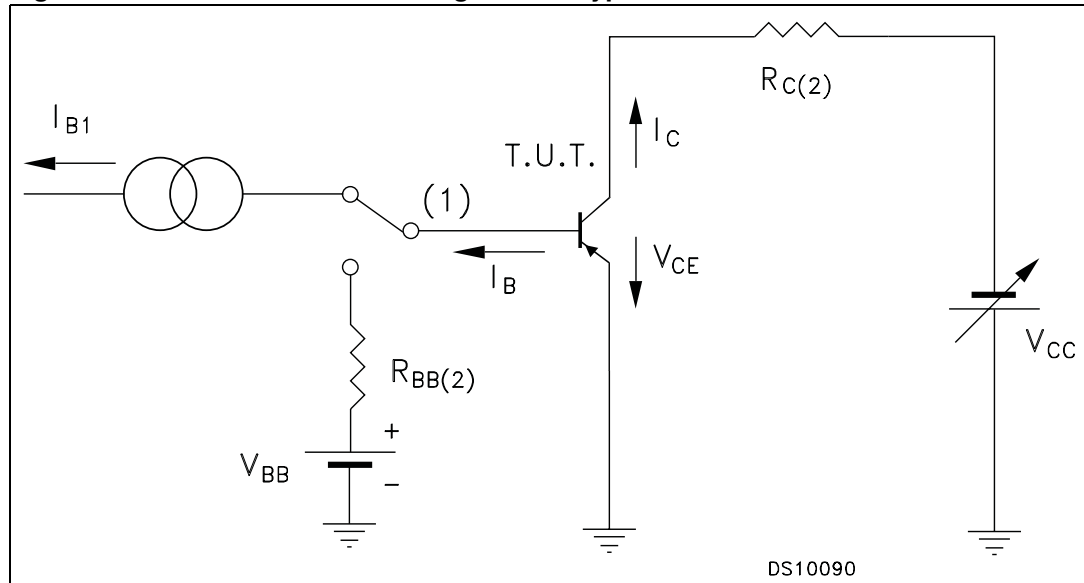

- 1. Fast electronic switch
- 2. Non-inductive resistor

4 Package mechanical data

In order to meet environmental requirements, ST offers these devices in different grades of ECOPACK® packages, depending on their level of environmental compliance. ECOPACK® specifications, grade definitions and product status are available at: www.st.com. ECOPACK is an ST trademark.

TO-252 (DPAK) mechanical data

DIM.	mm.		
	min.	typ	max.
A	2.20		2.40
A1	0.90		1.10
A2	0.03		0.23
b	0.64		0.90
b4	5.20		5.40
c	0.45		0.60
c2	0.48		0.60
D	6.00		6.20
D1		5.10	
E	6.40		6.60
E1		4.70	
e		2.28	
e1	4.40		4.60
H	9.35		10.10
L	1		
L1		2.80	
L2		0.80	
L4	0.60		1
R		0.20	
V2	0°		8°

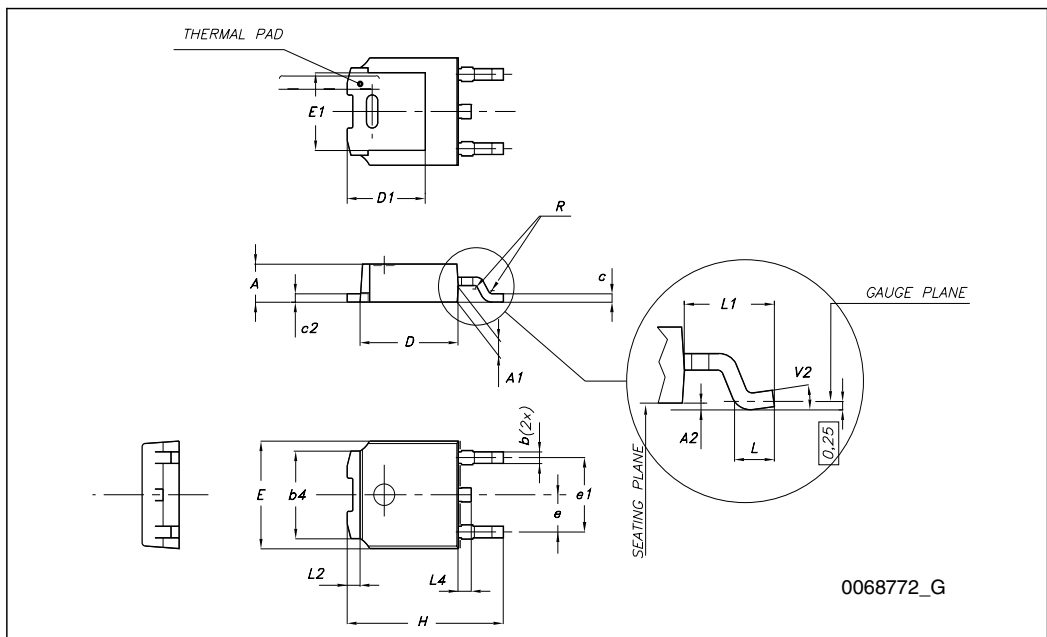

5 Revision history

Table 5. Document revision history

Date	Revision	Changes
01-Aug-2002	8	
01-Oct-2007	9	Collector current limits have been improved
03-Oct-2007	10	Package mechanical data updated
21-Apr-2009	11	The device MJD127 has been inserted Section 2.1: Electrical characteristics (curves) has been updated

Please Read Carefully:

Information in this document is provided solely in connection with ST products. STMicroelectronics NV and its subsidiaries ("ST") reserve the right to make changes, corrections, modifications or improvements, to this document, and the products and services described herein at any time, without notice.

All ST products are sold pursuant to ST's terms and conditions of sale.

Purchasers are solely responsible for the choice, selection and use of the ST products and services described herein, and ST assumes no liability whatsoever relating to the choice, selection or use of the ST products and services described herein.

No license, express or implied, by estoppel or otherwise, to any intellectual property rights is granted under this document. If any part of this document refers to any third party products or services it shall not be deemed a license grant by ST for the use of such third party products or services, or any intellectual property contained therein or considered as a warranty covering the use in any manner whatsoever of such third party products or services or any intellectual property contained therein.

UNLESS OTHERWISE SET FORTH IN ST'S TERMS AND CONDITIONS OF SALE ST DISCLAIMS ANY EXPRESS OR IMPLIED WARRANTY WITH RESPECT TO THE USE AND/OR SALE OF ST PRODUCTS INCLUDING WITHOUT LIMITATION IMPLIED WARRANTIES OF MERCHANTABILITY, FITNESS FOR A PARTICULAR PURPOSE (AND THEIR EQUIVALENTS UNDER THE LAWS OF ANY JURISDICTION), OR INFRINGEMENT OF ANY PATENT, COPYRIGHT OR OTHER INTELLECTUAL PROPERTY RIGHT.

UNLESS EXPRESSLY APPROVED IN WRITING BY AN AUTHORIZED ST REPRESENTATIVE, ST PRODUCTS ARE NOT RECOMMENDED, AUTHORIZED OR WARRANTED FOR USE IN MILITARY, AIR CRAFT, SPACE, LIFE SAVING, OR LIFE SUSTAINING APPLICATIONS, NOR IN PRODUCTS OR SYSTEMS WHERE FAILURE OR MALFUNCTION MAY RESULT IN PERSONAL INJURY, DEATH, OR SEVERE PROPERTY OR ENVIRONMENTAL DAMAGE. ST PRODUCTS WHICH ARE NOT SPECIFIED AS "AUTOMOTIVE GRADE" MAY ONLY BE USED IN AUTOMOTIVE APPLICATIONS AT USER'S OWN RISK.

Resale of ST products with provisions different from the statements and/or technical features set forth in this document shall immediately void any warranty granted by ST for the ST product or service described herein and shall not create or extend in any manner whatsoever, any liability of ST.

ST and the ST logo are trademarks or registered trademarks of ST in various countries.

Information in this document supersedes and replaces all information previously supplied.

The ST logo is a registered trademark of STMicroelectronics. All other names are the property of their respective owners.

© 2009 STMicroelectronics - All rights reserved

STMicroelectronics group of companies

Australia - Belgium - Brazil - Canada - China - Czech Republic - Finland - France - Germany - Hong Kong - India - Israel - Italy - Japan - Malaysia - Malta - Morocco - Philippines - Singapore - Spain - Sweden - Switzerland - United Kingdom - United States of America

www.st.com

Компания «Life Electronics» занимается поставками электронных компонентов импортного и отечественного производства от производителей и со складов крупных дистрибьюторов Европы, Америки и Азии.

С конца 2013 года компания активно расширяет линейку поставок компонентов по направлению коаксиальный кабель, кварцевые генераторы и конденсаторы (керамические, пленочные, электролитические), за счёт заключения дистрибьюторских договоров

Мы предлагаем:

- Конкурентоспособные цены и скидки постоянным клиентам.
- Специальные условия для постоянных клиентов.
- Подбор аналогов.
- Поставку компонентов в любых объемах, удовлетворяющих вашим потребностям.
- Приемлемые сроки поставки, возможна ускоренная поставка.
- Доставку товара в любую точку России и стран СНГ.
- Комплексную поставку.
- Работу по проектам и поставку образцов.
- Формирование склада под заказчика.
- Сертификаты соответствия на поставляемую продукцию (по желанию клиента).
- Тестирование поставляемой продукции.
- Поставку компонентов, требующих военную и космическую приемку.
- Входной контроль качества.
- Наличие сертификата ISO.

В составе нашей компании организован Конструкторский отдел, призванный помогать разработчикам, и инженерам.

Конструкторский отдел помогает осуществить:

- Регистрацию проекта у производителя компонентов.
- Техническую поддержку проекта.
- Защиту от снятия компонента с производства.
- Оценку стоимости проекта по компонентам.
- Изготовление тестовой платы монтаж и пусконаладочные работы.



Тел: +7 (812) 336 43 04 (многоканальный)

Email: org@lifeelectronics.ru