

Index

Series Swisstac

| | | |
|----------------|--------------------------------------|-----------------|
| | Description | Page 583 |
| | Product Assembly | Page 584 |
| | Mounting Instruction | Page 585 |
| | Product Range | |
| | - pushbuttons for standard mounting | Page 591 |
| | - pushbuttons for flush mounting | Page 608 |
| | - accessories / spare parts | Page 622 |
| | Technical Data | Page 638 |
| | Drawing / Dimension / Layouts | Page 642 |
| | Circuit Drawing | Page 657 |
| Marking | Page 667 | |

SWISSTAC - Three crucial advantages!

Easy storage in minimum space
Every SWISSTAC switch can be altered very simply any number of times, and afterwards added to, modified or adapted. This highly modular concept means that only a few subassemblies reducing storage costs.

All connections on one plane

All the terminals are arranged at the same level, are clearly laid out and fully accessible even when in close-packed arrays. Three colours provide optical help to make connections easier.

Ideal for switch interlock systems

SWISSTAC switches can be mechanically combined in many ways to form switch interlock systems and in fact in rows of up to 20 switches. This means that complicated protection and relay interlocks are unnecessary. Individual and irregular spacings between the switches of an array are no problem either.

CE

Our products are marked with the internationally approved CE low-voltage safety standard.

General information

Swisstac, a modularly constructed control switch system, offers the user a wide range of products: buzzers, illuminated pushbuttons and pushbuttons, indicators, emergency stop switches, push-pull illuminated switches, keylock switches and selector switches, as well as switch interlock systems in the front-facing protection classes IP 40 and IP 65.

The front dimensions of the switch units are: 18 mm dia., 18 x 18 mm, 24 mm dia., 24 x 24 mm. For flush mounting, dimensions 25 mm dia., 24 x 24 mm, 24 x 30 mm are also available.

Construction

SWISSTAC switches are of modular construction and are divided into the following three groups:

- Front section: Man/switch interface and status indicator two-part lens for engraving, film insert or printing
- Intermediate section: Latching/ pulse facility, lamp holder, latch function
- Intermediate section with switching mechanism and lamp holder, which is available in two versions: T: 5.5 max., 1.2 W and midget grooved T 1 3/4 max.

1.2 W.

- Terminal block: up to a max. of five switching elements can be joined together in one switch terminal block. Are supplied mounted serially on intermediate sections.

Can be disassembled easily for wiring.

Marking

Engraved, printed film inlay see under 'Marking' page 667.

Illumination

Perfect illumination of the lenses supplied in various colours is guaranteed by the incandescent lamps midget grooved T 1 3/4 and T 5.5 (6-60V9).

Where supply voltages are over 60 V, a voltage-reduction element (ext. protective series resistor or capacitor) must be used. Because of high surface temperature, the protective series resistor may not be soldered direct onto the connections of the pushbuttons.

Multi-LED midget grooved T 1 3/4 and T 5.5 (6, 12, 24, 48 V) are available in the colours red, yellow and green.

Switch position indicator

When the pushbutton with latch function is operated, the lens latches in mechanically. The position of the lens makes the switch position evident at all the times.

Keylock switches

Standard lock

1 Standard number is B2 300. We supply B2 300 without specifications of the lock numbers. Four further standard locks are B2 301 - B2 304. This additional designation should be quoted when ordering. A further 95 locks are available in or without passepartout version on request. 2 keys are supplied per keylock switch.

Spare keys for a standard lock can be ordered under Type no. 240-2001-00 (please quote lock number). Example: 240-200-00 B2 300.

Emergency stop switch with key to unlock

Standard lock is B2 390. Four further standard locks are B2 391 - B2-394. When ordering this additional designation should be quoted. Spare keys for standard lock can be ordered under Type no. 240-3001-00 (please quote lock). Example: 240-3001-00 B2 390.

Two keys are supplied per emergency stop switch.

Emergency Stop Switch, foolproof with key to unlock

Kaba safety switch. Standard lock number is 1001. Spare keys can be ordered under Type no. 240.4001-00 1001.

2 keys are supplied per emergency stop switches.

All measurements in mm

Technical specifications subject to modification.

illuminated-/pushbutton

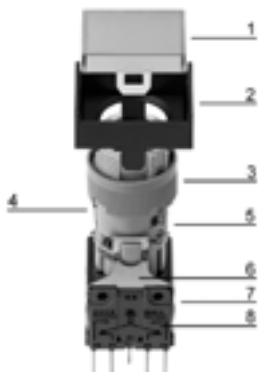

- 1 lens
- 2 front bezel
- 3 fixing nut
- 4 spring with pin for changing from maintained to momentary
- 5 intermediate section
- 6 holder for switching element
- 7 switching element block
- 8 switching element

pushbutton-/illuminated pushbutton for flush mounting

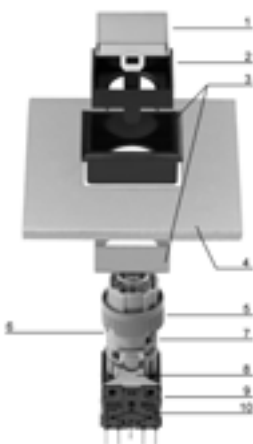

- 1 lens
- 2 front bezel
- 3 front bezel set f. fl. mounting
- 4 front panel
- 5 fixing nut
- 6 spring with pin f. changing from main to mom
- 7 intermediate section
- 8 holder f. switching element
- 9 switching element block
- 10 switching element

illuminated-/pushbutton 35mm

The switch is mounted in a fascia or control panel in three steps:

1. Detach terminal block as in drawing, remove fixing nut
2. Insert switch from the front in fascia/control panel
3. Reassemble the switch in the reverse order

To detach terminal block

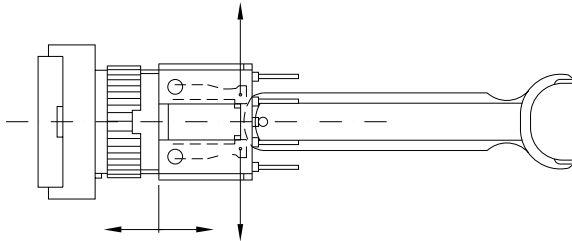

Note: Type-identification on legs of actuator

illuminated-/pushbutton 55 - 70 mm

The switch is mounted in a fascia/control panel in two steps:

1. Insert switch from back side in fascia/control panel
2. Snap on bezel and tighten fixing nut

Lens

Bezel

Illuminated pushbutton

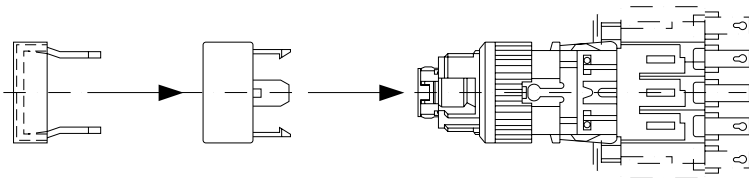

illuminated-/pushbutton 55 - 70 mm sealing gland and -ring

The first time the button is pressed, the gland is forced into its groove and becomes effective.

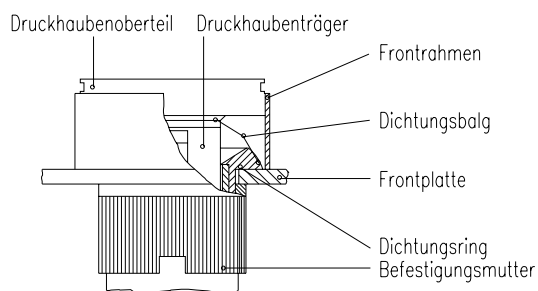

indicator 30 - 70 mm

The indicator is mounted in a fascia/control panel in two steps:

1. Insert indicator from back side in fascia/control panel
2. Snap on bezel and tighten fixing nut

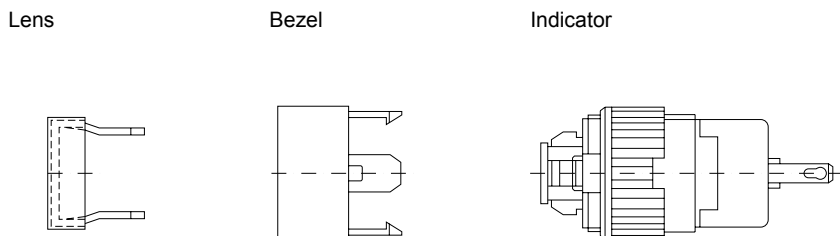

indicator 30 - 70 mm sealing gland, -ring and press ring

The press ring is fitted between gland and lens. The seal is effective when the lens is snapped into place.

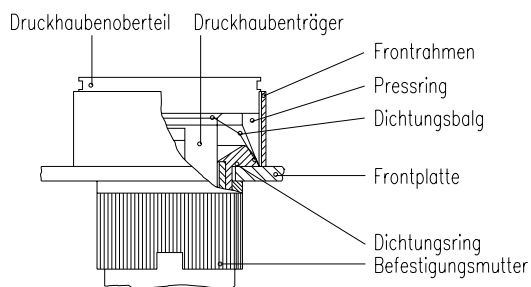

emergency stop switch turn to release 55 - 70 mm

The switch is mounted in a fascia or control panel in three steps:

1. Detach front section just in released position, as in drawing
2. Insert switch from back side in fascia/control panel
3. Snap on front section and tighten fixing nut

Important for IP 65

With models to IP 65, the sealing ring 1) is already fitted. This must be removed if the SWISSTAC emergency Stop identity plate (IP 65 model) is used.

Sealing ring 2) is fitted as standard in models to IP 65.

Zero position Identity plate Wiring diagram

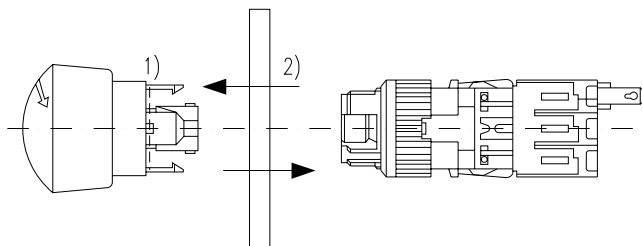

emergency stop switch with key release 55 - 70 mm

The switch is mounted in a fascia or control panel in three steps:

1. Detach front section, just in released position, as in drawing, remove fixing nut
2. Insert switch from back side in fascia/control panel
3. Snap on front section and tighten fixing nut

Important for IP 65

With models to IP 65, the sealing ring1) is already fitted
This must be removed if the SWISSTAC emergency
Stop identity plate (IP 65 model) is used.

Sealing ring2) is fitted as standard
in models to IP 65.

Zero position

Identity plate

Wiring diagram

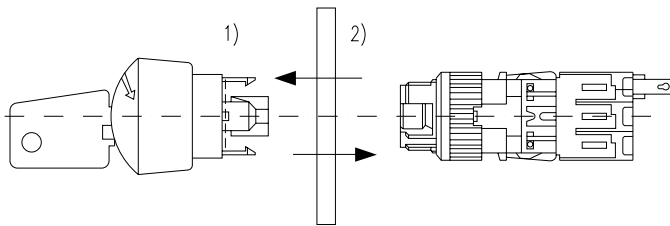

emergency stop switch foolproof

Hint for mounting: the torque with which the fixing nut is tightened must not exceed 50 Ncm.

Hint for dismounting: dismantling of switching element just with dismantling tool.

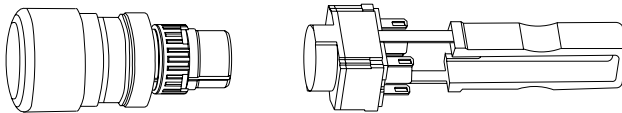

keylock switch 45mm

The switch is mounted in a fascia or control panel in three steps:

1. Detach terminal block as in drawing, remove fixing nut
2. Insert switch from front side in fascia/control panel
3. Reassemble the switch in the reverse order

To detach terminal block

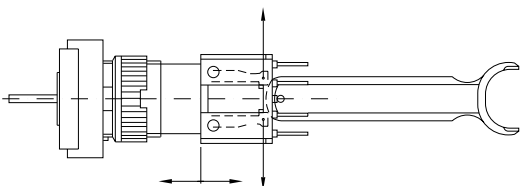

keylock switch 55 mm

The switch is mounted in a fascia/control panel in three steps:

1. Remove front section as in drawing
2. Insert switch from back side in fascia/control panel
3. Snap on front section (see Note) and tighten fixing nut

Zero position

Wiring diagram

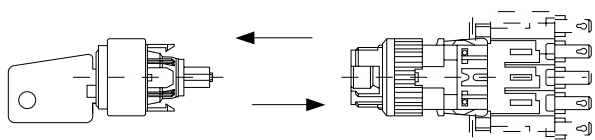

To assemble, the key must be at the zero position, the symbol **0** is at the top, and on the terminal block the circuit diagram is uppermost.

keylock switch 70 mm

The switch is mounted in a fascia/control panel in three steps:

1. Remove front section as in drawing
2. Insert switch from back side in fascia/control panel
3. Snap on front section (see Note) and tighten fixing nut.

Zero position

Wiring diagram

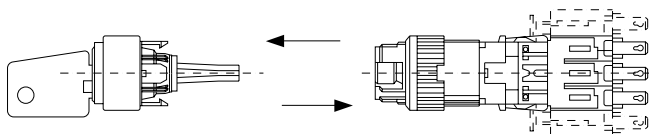

To assemble, the key must be at the zero position, the symbol **0** is at the top, and on the terminal block the circuit diagram is uppermost.

selector switch 45 mm

The switch is mounted in a fascia or control panel in three steps:

1. Detach terminal block as in drawing, remove fixing nut
2. Insert switch from front side in fascia/control panel
3. Reassemble the switch in the reverse order

To detach terminal block

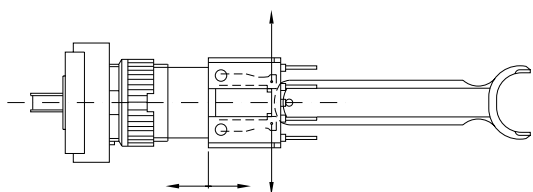

selector switch 55 mm

The switch is mounted in a fascia/control panel in three steps:

1. Remove front section as in drawing
2. Insert switch from back side in fascia/control panel
3. Snap on front section (see Note) and tighten fixing nut

Zero position

Wiring diagram

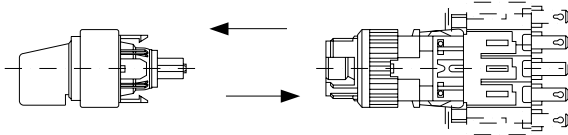

To assemble, the lever must be at the zero position, the symbol **0** is as the top, and on the terminal block the circuit diagram is uppermost.

selector switch 70 mm

The switch is mounted in a fascia/control panel in three steps:

1. Remove front section as in drawing
2. Insert switch from back side in fascia/control panel
3. Snap on front section (see Note) and tighten fixing nut

Zero position

Wiring diagram

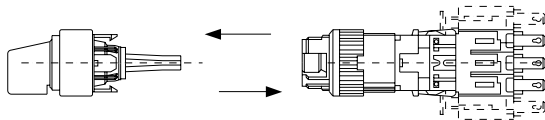

To assemble, the lever must be at the zero position, the symbol **0** is at the top, and on the terminal block the circuit diagram is uppermost.

push pull illuminated switch

The switch is mounted in a fascia or control panel in three steps:

1. Detach terminal block as in drawing, remove fixing nut
2. Insert switch from back side in fascia/control panel
3. Reassemble the switch in the reverse order

Push-Pull knob

To detach terminal block

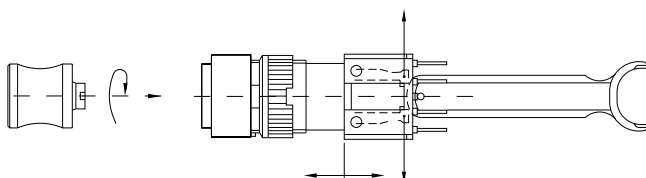

Push-pull knob can be mounted in only one position. Zero position Wiring diagram

buzzer 30 - 55 mm

The alarmbuzzer is mounted in a fascia/control panel in two steps:

1. Insert alarmbuzzer from backside in fascia/control panel
2. snap on bezel and tighten fixing nut

buzzerelement

bezel

buzzerhousing

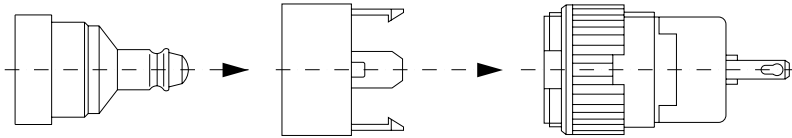

indicator actuator 35 mm



- 🛒 lens for 35 mm page 622
- 🛒 lamp element block for 35 mm page 632
- 🛒 filament lamp MG T 1 3/4 page 634
- 🛒 LED MG T 1 3/4 page 634

| | degree of protection | □ 18 x 24 mm Typ-Nr. | ∅ 18 x 18 mm Typ-Nr. | 18 mm dia. Typ-Nr. | circuit drawing | technical drawing | mounting dimensions | component layout | 📄 |
|--|----------------------|----------------------------|----------------------------|-----------------------|-----------------|-------------------|---------------------|------------------|-------|
| indicator actuator 35 mm lampholder MG T 1 3/4 | IP 40 | 690-6000-00 | 690-4000-00 | 690-2000-00 | 1 | 1 | 1 | 1 | 0,004 |
| | IP 65 | 690-6000-W0 | 690-4000-W0 | 690-2000-W0 | 1 | 1 | 2 | 1 | 0,005 |

circuit drawings from page 657, technical drawings from page 642, mounting dimensions from page 652, component layouts from page 657

indicator 30 - 70 mm

protection degree IP 40/IP 65 is determined by front bezel and lens



- 🛒 lens page 623
- 🛒 front bezel for illuminated-/pushbutton 55 - 70 mm and indicator 30 - 70 mm page 627
- 🛒 pressure ring page 630
- 🛒 filament lamp MG T 1 3/4 page 634
- 🛒 LED MG T 1 3/4 page 634
- 🛒 filament lamp T 5.5 page 634
- 🛒 LED T 5.5 page 635

| | mounting depth | connection method | lamp socket | part no. | circuit drawing | technical drawing | mounting dimensions | component layout | 📄 |
|-----------------------------|----------------|-------------------|-------------|--------------------|-----------------|-------------------|---------------------|------------------|-------|
| indicator 30 - 70 mm | 30 mm | - | MG T 1 3/4 | 990-.000-K0 | 1 | 2 | 3 | | 0,004 |
| | 45 mm | - | T 5.5 | 890-.000-K0 | 1 | 3 | 3 | | 0,006 |
| | 52 mm | P | MG T 1 3/4 | 990-.000-0P | 1 | 4 | 3 | 1 | 0,007 |
| | 55 mm | - | MG T 1 3/4 | 990-.000-00 | 1 | 5 | 3 | | 0,007 |
| | 67 mm | P | T 5.5 | 890-.000-0P | 1 | 6 | 3 | 1 | 0,010 |
| | 70 mm | - | T 5.5 | 890-.000-00 | 1 | 7 | 3 | | 0,010 |

connection method : soldering-/plug-in terminal = -, PCB terminal = P

The indicators 55 mm and 70 mm are as long as the corresponding illuminated pushbuttons and fit to the PCB plug-in base and multi-plug housing.
circuit drawings from page 657, technical drawings from page 642, mounting dimensions from page 652, component layouts from page 657

pushbutton-/illuminated pushbutton actuator 35 mm



🛒 lens for 35 mm page 622

🛒 filament lamp MG T 1 3/4 page 634

🛒 LED MG T 1 3/4 page 634

🛒 snap-action switching element block for 35 mm page 631

| | degree of protection | switching action | □ 18 x 24 mm Typ-Nr. | ⊕ 18 x 18 mm Typ-Nr. | 18 mm dia. Typ-Nr. | circuit drawing | technical drawing | mounting dimensions | component layout | |
|---|----------------------|------------------|----------------------------|----------------------------|-----------------------|-----------------|-------------------|---------------------|------------------|-------|
| pushbutton-/illuminated pushbutton actuator 35 mm lampholder MG T 1 3/4 | IP 40 | M | 680-6000-00 | 680-4000-00 | 680-2000-00 | 2 | 1 | 1 | 1 | 0,004 |
| | | MA | 600-6000-00 | 600-4000-00 | 600-2000-00 | 3 | 1 | 1 | 1 | 0,004 |
| | IP 65 | M | 680-6000-W0 | 680-4000-W0 | 680-2000-W0 | 2 | 1 | 2 | 1 | 0,005 |
| | | MA | 600-6000-W0 | 600-4000-W0 | 600-2000-W0 | 3 | 1 | 2 | 1 | 0,005 |

switching action : momentary action = M, maintained action = MA (changeable to momentary action, reversible)

circuit drawings from page 657, technical drawings from page 642, mounting dimensions from page 652, component layouts from page 657

illuminated-/pushbutton 55 - 70 mm

protection degree IP 40/IP 65 is determined by front bezel and lens



- 🛒 lens page 623
- 🛒 front bezel for illuminated-/pushbutton 55 - 70 mm and indicator 30 - 70 mm page 627
- 🛒 filament lamp MG T 1 3/4 page 634
- 🛒 filament lamp T 5.5 page 634
- 🛒 LED T 5.5 page 635

| | mounting depth | contacts | switching action | connection method | lamp socket | part no. | circuit drawing | technical drawing | mounting dimensions | component layout | |
|---|----------------|-------------|------------------|-------------------|-------------|--------------------|-----------------|-------------------|---------------------|------------------|-------|
| illuminated-/pushbutton 55 - 70 mm | 52 mm | 1 NC + 1 NO | MA | P | MG T 1 3/4 | 901-.000-0P | 4 | 8 | 3 | 1 | 0,013 |
| | | 2 NC + 2 NO | MA | P | MG T 1 3/4 | 902-.000-0P | 5 | 8 | 3 | 1 | 0,014 |
| | | 3 NC + 3 NO | MA | P | MG T 1 3/4 | 903-.000-0P | 6 | 8 | 3 | 1 | 0,014 |
| | | 4 NC + 4 NO | MA | P | MG T 1 3/4 | 904-.000-0P | 7 | 8 | 3 | 1 | 0,018 |
| | | 5 NC + 5 NO | MA | P | MG T 1 3/4 | 905-.000-0P | 8 | 8 | 3 | 1 | 0,021 |
| | 55 mm | 1 NC + 1 NO | MA | - | MG T 1 3/4 | 901-.000-00 | 4 | 9 | 3 | | 0,013 |
| | | 2 NC + 2 NO | MA | - | MG T 1 3/4 | 902-.000-00 | 5 | 9 | 3 | | 0,014 |
| | | 3 NC + 3 NO | MA | - | MG T 1 3/4 | 903-.000-00 | 6 | 9 | 3 | | 0,015 |
| | | 4 NC + 4 NO | MA | - | MG T 1 3/4 | 904-.000-00 | 7 | 9 | 3 | | 0,019 |
| | | 5 NC + 5 NO | MA | - | MG T 1 3/4 | 905-.000-00 | 8 | 9 | 3 | | 0,022 |
| | 67 mm | 1 NC + 1 NO | MA | P | T 5.5 | 801-.000-0P | 4 | 10 | 3 | 1 | 0,015 |
| | | 2 NC + 2 NO | MA | P | T 5.5 | 802-.000-0P | 5 | 10 | 3 | 1 | 0,016 |
| | | 3 NC + 3 NO | MA | P | T 5.5 | 803-.000-0P | 6 | 10 | 3 | 1 | 0,017 |
| | | 4 NC + 4 NO | MA | P | T 5.5 | 804-.000-0P | 7 | 10 | 3 | 1 | 0,020 |
| | | 5 NC + 5 NO | MA | P | T 5.5 | 805-.000-0P | 8 | 10 | 3 | 1 | 0,023 |
| | 70 mm | 1 NC + 1 NO | MA | - | T 5.5 | 801-.000-00 | 4 | 11 | 3 | | 0,015 |
| | | 2 NC + 2 NO | MA | - | T 5.5 | 802-.000-00 | 5 | 11 | 3 | | 0,016 |
| | | 3 NC + 3 NO | MA | - | T 5.5 | 803-.000-00 | 6 | 11 | 3 | | 0,017 |
| | | 4 NC + 4 NO | MA | - | T 5.5 | 804-.000-00 | 7 | 11 | 3 | | 0,021 |
| | | 5 NC + 5 NO | MA | - | T 5.5 | 805-.000-00 | 8 | 11 | 3 | | 0,024 |

contacts : normally closed = NC, normally open = NO

switching action : maintained action = MA (changeable to momentary action, reversible)

connection method : PCB terminal = P, soldering-/plug-in terminal = -

circuit drawings from page 657, technical drawings from page 642, mounting dimensions from page 652, component layouts from page 657

emergency stop switch 55 - 70 mm



🛒 label for emergency stop switch page 636

| | unlocking | degree of protection | mounting depth | contacts | connection method | 24 mm dia. Typ-Nr. | circuit drawing | technical drawing | mounting dimensions | component layout | |
|---|------------------|----------------------|----------------|----------|-------------------|--------------------|-----------------|-------------------|---------------------|------------------|-------|
| emergency stop switch 55 - 70 mm according to VDE max. 2 NC are permitted | twist to release | IP 40 | 52 mm | 1 NC | P | 951+2000-0P | 9 | 12 | 4 | 1 | 0,018 |
| | | | | 2 NC | P | 952+2000-0P | 10 | 12 | 4 | 1 | 0,019 |
| | | | | 3 NC | P | 953+2000-0P | 11 | 12 | 4 | 1 | 0,020 |
| | | | 55 mm | 1 NC | - | 951+2000-00 | 9 | 13 | 4 | | 0,018 |
| | | | | 2 NC | - | 952+2000-00 | 10 | 13 | 4 | | 0,019 |
| | | | | 3 NC | - | 953+2000-00 | 11 | 13 | 4 | | 0,020 |
| | | | 67 mm | 1 NC | P | 851+2000-0P | 9 | 14 | 4 | 1 | 0,021 |
| | | | | 2 NC | P | 852+2000-0P | 10 | 14 | 4 | 1 | 0,022 |
| | | | | 3 NC | P | 853+2000-0P | 11 | 14 | 4 | 1 | 0,023 |
| | | | 70 mm | 1 NC | - | 851+2000-00 | 9 | 15 | 4 | | 0,021 |
| | | | | 2 NC | - | 852+2000-00 | 10 | 15 | 4 | | 0,022 |
| | | | | 3 NC | - | 853+2000-00 | 11 | 15 | 4 | | 0,023 |
| | | IP 65 | 52 mm | 1 NC | P | 951+2000-WP | 9 | 12 | 5 | 1 | 0,018 |
| | | | | 2 NC | P | 952+2000-WP | 10 | 12 | 5 | 1 | 0,019 |
| | | | | 3 NC | P | 953+2000-WP | 11 | 12 | 5 | 1 | 0,020 |
| | | | 55 mm | 1 NC | - | 951+2000-W0 | 9 | 13 | 5 | | 0,018 |
| | | | | 2 NC | - | 952+2000-W0 | 10 | 13 | 5 | | 0,019 |
| | | | | 3 NC | - | 953+2000-W0 | 11 | 13 | 5 | | 0,020 |
| | | | 67 mm | 1 NC | P | 851+2000-WP | 9 | 14 | 5 | 1 | 0,021 |
| | | | | 2 NC | P | 852+2000-WP | 10 | 14 | 5 | 1 | 0,022 |
| | | | | 3 NC | P | 853+2000-WP | 11 | 14 | 5 | 1 | 0,023 |
| | | | 70 mm | 1 NC | - | 851+2000-W0 | 9 | 15 | 5 | | 0,021 |
| | | | | 2 NC | - | 852+2000-W0 | 10 | 15 | 5 | | 0,022 |
| | | | | 3 NC | - | 853+2000-W0 | 11 | 15 | 5 | | 0,023 |

Continued on next page

| | unlocking | degree of protection | mounting depth | contacts | connection method | 24 mm dia. Typ-Nr. | circuit drawing | technical drawing | mounting dimensions | component layout | |
|---|----------------|----------------------|----------------|----------|-------------------|-----------------------|-----------------|-------------------|---------------------|------------------|-------|
| emergency stop switch 55 - 70 mm standard lock B2 390, other lock numbers on request according to VDE max. 2 NC are permitted | key to release | IP 40 | 52 mm | 1 NC | P | 961+2401-0P | 9 | 12 | 4 | 1 | 0,030 |
| | | | | 2 NC | P | 962+2401-0P | 10 | 12 | 4 | 1 | 0,031 |
| | | | | 3 NC | P | 963+2401-0P | 11 | 12 | 4 | 1 | 0,032 |
| | | | 55 mm | 1 NC | - | 961+2401-00 | 9 | 13 | 4 | | 0,030 |
| | | | | 2 NC | - | 962+2401-00 | 10 | 13 | 4 | | 0,031 |
| | | | | 3 NC | - | 963+2401-00 | 11 | 13 | 4 | | 0,032 |
| | | | 67 mm | 1 NC | P | 861+2401-0P | 9 | 14 | 4 | 1 | 0,033 |
| | | | | 2 NC | P | 862+2401-0P | 10 | 14 | 4 | 1 | 0,034 |
| | | | | 3 NC | P | 863+2401-0P | 11 | 14 | 4 | 1 | 0,035 |
| | | | 70 mm | 1 NC | - | 861+2401-00 | 9 | 15 | 4 | | 0,033 |
| | | | | 2 NC | - | 862+2401-00 | 10 | 15 | 4 | | 0,034 |
| | | | | 3 NC | - | 863+2401-00 | 11 | 15 | 4 | | 0,035 |
| | | IP 65 | 52 mm | 1 NC | P | 961+2401-WP | 9 | 12 | 5 | 1 | 0,030 |
| | | | | 2 NC | P | 962+2401-WP | 10 | 12 | 5 | 1 | 0,031 |
| | | | | 3 NC | P | 963+2401-WP | 11 | 12 | 5 | 1 | 0,032 |
| | | | 55 mm | 1 NC | - | 961+2401-W0 | 9 | 13 | 5 | | 0,030 |
| | | | | 2 NC | - | 962+2401-W0 | 10 | 13 | 5 | | 0,031 |
| | | | | 3 NC | - | 963+2401-W0 | 11 | 13 | 5 | | 0,032 |
| | | | 67 mm | 1 NC | P | 861+2401-WP | 9 | 14 | 5 | 1 | 0,033 |
| | | | | 2 NC | P | 862+2401-WP | 10 | 14 | 5 | 1 | 0,034 |
| | | | | 3 NC | P | 863+2401-WP | 11 | 14 | 5 | 1 | 0,035 |
| | | | 70 mm | 1 NC | - | 861+2401-W0 | 9 | 15 | 5 | | 0,033 |
| | | | | 2 NC | - | 862+2401-W0 | 10 | 15 | 5 | | 0,034 |
| | | | | 3 NC | - | 863+2401-W0 | 11 | 15 | 5 | | 0,035 |

contacts : 1 normally closed = 1 NC, normally closed = NC

connection method : PCB terminal = P, soldering-/plug-in terminal = -

hint:

- we recommend to use location strip no. 260-0020-00 for anti-twisting of the front bezel.

- at momentary position the overturning force is max. 60 Ncm.

circuit drawings from page 657, technical drawings from page 642, mounting dimensions from page 652, component layouts from page 657

emergency stop switch foolproof 41 mm

according to EN 418



label for emergency stop switch page 636

| | unlocking | degree of protection | mounting depth | contacts | connection method | 27 mm dia. Typ-Nr. | circuit drawing | technical drawing | mounting dimensions | |
|--|------------------|----------------------|----------------|-------------|-------------------|--------------------|-----------------|-------------------|---------------------|-------|
| emergency stop switch foolproof 41 mm | twist to release | IP 65 | 41 mm | 1 NC | - | 551-8000-W0 | 12 | 16 | 6 | 0,025 |
| | | | | 1 NC + 1 NO | - | 553-8000-W0 | 13 | 16 | 6 | 0,025 |
| | | | | 2 NC | - | 552-8000-W0 | 14 | 16 | 6 | 0,025 |
| standard lock 1001 | key to release | IP 65 | 41 mm | 1 NC | - | 561-8101-W0 | 12 | 16 | 6 | 0,047 |
| | | | | 1 NC + 1 NO | - | 563-8101-W0 | 13 | 16 | 6 | 0,047 |
| | | | | 2 NC | - | 562-8101-W0 | 14 | 16 | 6 | 0,047 |

contacts : 1 normally closed = 1 NC, normally closed = NC, normally open = NO

connection method : soldering-/plug-in terminal = -

Mounting hint: starting torque for fixing nut max. 50 Ncm

circuit drawings from page 657, technical drawings from page 642, mounting dimensions from page 652

pushbutton with mushroom-head cap 55 - 70 mm



🛒 mushroom-head cap page 625

🛒 front bezel for mushroom-head pushbutton 55 - 70 mm page 628

| | degree of protection | mounting depth | contacts | switching action | connection method | part no. | circuit drawing | technical drawing | mounting dimensions | component layout | |
|---|----------------------|----------------|-------------|------------------|-------------------|--------------------|-----------------|-------------------|---------------------|------------------|-------|
| pushbutton with mushroom-head cap 55 - 70 mm | IP 40 | 52 mm | 1 NC + 1 NO | maintained | P | 901-.000-0P | 15 | 17 | 7 | 1 | 0,013 |
| | | | 2 NC + 2 NO | maintained | P | 902-.000-0P | 16 | 17 | 7 | 1 | 0,014 |
| | | | 3 NC + 3 NO | maintained | P | 903-.000-0P | 17 | 17 | 7 | 1 | 0,014 |
| | | | 4 NC + 4 NO | maintained | P | 904-.000-0P | 18 | 17 | 7 | 1 | 0,018 |
| | | | 5 NC + 5 NO | maintained | P | 905-.000-0P | 19 | 17 | 7 | 1 | 0,021 |
| | | 55 mm | 1 NC + 1 NO | maintained | - | 901-.000-00 | 15 | 18 | 7 | | 0,013 |
| | | | 2 NC + 2 NO | maintained | - | 902-.000-00 | 16 | 18 | 7 | | 0,014 |
| | | | 3 NC + 3 NO | maintained | - | 903-.000-00 | 17 | 18 | 7 | | 0,015 |
| | | | 4 NC + 4 NO | maintained | - | 904-.000-00 | 18 | 18 | 7 | | 0,019 |
| | | | 5 NC + 5 NO | maintained | - | 905-.000-00 | 19 | 18 | 7 | | 0,022 |
| | | 67 mm | 1 NC + 1 NO | maintained | P | 801-.000-0P | 15 | 19 | 7 | 1 | 0,015 |
| | | | 2 NC + 2 NO | maintained | P | 802-.000-0P | 16 | 19 | 7 | 1 | 0,016 |
| | | | 3 NC + 3 NO | maintained | P | 803-.000-0P | 17 | 19 | 7 | 1 | 0,017 |
| | | | 4 NC + 4 NO | maintained | P | 804-.000-0P | 18 | 19 | 7 | 1 | 0,020 |
| | | | 5 NC + 5 NO | maintained | P | 805-.000-0P | 19 | 19 | 7 | 1 | 0,023 |
| | | 70 mm | 1 NC + 1 NO | maintained | - | 801-.000-00 | 15 | 20 | 7 | | 0,015 |
| | | | 2 NC + 2 NO | maintained | - | 802-.000-00 | 16 | 20 | 7 | | 0,016 |
| | | | 3 NC + 3 NO | maintained | - | 803-.000-00 | 17 | 20 | 7 | | 0,017 |
| | | | 4 NC + 4 NO | maintained | - | 804-.000-00 | 18 | 20 | 7 | | 0,021 |
| | | | 5 NC + 5 NO | maintained | - | 805-.000-00 | 19 | 20 | 7 | | 0,024 |

contacts : normally closed = NC, normally open = NO

switching action: maintained action = MA (changeable to momentary action, reversible)

connection method : PCB terminal = P, soldering-/plug-in terminal = -

circuit drawings from page 657, technical drawings from page 642, mounting dimensions from page 652, component layouts from page 657

keylock switch 2 positions 45 - 70 mm



front cap for keylock-/selector switch 2 positions page 625

| | degree of protection | mounting depth | contacts | switching action | connection method | key removable in | part no. | circuit drawing | technical drawing | mounting dimensions | component layout | |
|---|----------------------|----------------|-------------|--------------------|-------------------|------------------|--------------------|-----------------|-------------------|---------------------|------------------|-------|
| | | | | | | | | | | | | |
| keylock switch 2 positions 45 - 70 mm standard lock B2 300, other lock numbers on re- quest | IP 40 | 42 mm | 1 NC + 1 NO | M | P | A | 781-.401-0P | 21 | 21 | 8 | 1 | 0,022 |
| | | | | MA | P | A | 771-.401-0P | 20 | 21 | 8 | 1 | 0,022 |
| | | | | | | A+C | 761-.401-0P | 20 | 21 | 8 | 1 | 0,022 |
| | | | 2 NC + 2 NO | M | P | A | 782-.401-0P | 23 | 21 | 8 | 1 | 0,023 |
| | | | | MA | P | A | 772-.401-0P | 22 | 21 | 8 | 1 | 0,023 |
| | | | | | | A+C | 762-.401-0P | 22 | 21 | 8 | 1 | 0,023 |
| | | 45 mm | 1 NC + 1 NO | M | - | A | 781-.401-00 | 21 | 22 | 8 | | 0,022 |
| | | | | MA | - | A | 771-.401-00 | 20 | 22 | 8 | | 0,022 |
| | | | | | | A+C | 761-.401-00 | 20 | 22 | 8 | | 0,022 |
| | | | 2 NC + 2 NO | M | - | A | 782-.401-00 | 23 | 22 | 8 | | 0,023 |
| | | | | MA | - | A | 772-.401-00 | 22 | 22 | 8 | | 0,023 |
| | | | | | | A+C | 762-.401-00 | 22 | 22 | 8 | | 0,023 |
| | | 52 mm | 1 NC + 1 NO | M | P | A | 931-.401-0P | 25 | 23 | 8 | 1 | 0,024 |
| | | | | MA | P | A | 921-.401-0P | 24 | 23 | 8 | 1 | 0,024 |
| | | | | | | A+C | 911-.401-0P | 24 | 23 | 8 | 1 | 0,024 |
| | | | 2 NC + 2 NO | M | P | A | 932-.401-0P | 23 | 23 | 8 | 1 | 0,025 |
| | | | | MA | P | A | 922-.401-0P | 22 | 23 | 8 | 1 | 0,025 |
| | | | | | | A+C | 912-.401-0P | 22 | 23 | 8 | 1 | 0,025 |
| | | | 3 NC + 3 NO | M | P | A | 933-.401-0P | 27 | 23 | 8 | 1 | 0,026 |
| | | | | MA | P | A | 923-.401-0P | 26 | 23 | 8 | 1 | 0,026 |
| | | | | | | A+C | 913-.401-0P | 26 | 23 | 8 | 1 | 0,026 |
| | | | 4 NC + 4 NO | M | P | A | 934-.401-0P | 29 | 23 | 8 | 1 | 0,029 |
| | | | | MA | P | A | 924-.401-0P | 28 | 23 | 8 | 1 | 0,029 |
| | | | | | | A+C | 914-.401-0P | 28 | 23 | 8 | 1 | 0,029 |
| 5 NC + 5 NO | M | P | A | 935-.401-0P | 31 | 23 | 8 | 1 | 0,032 | | | |
| | MA | P | A | 925-.401-0P | 30 | 23 | 8 | 1 | 0,032 | | | |
| | | | A+C | 915-.401-0P | 30 | 23 | 8 | 1 | 0,032 | | | |

Continued on next page

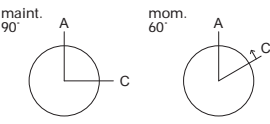
|  | degree of protection | mounting depth | contacts | switching action | connection method | key removable in | part no. | circuit drawing | technical drawing | mounting dimensions | component layout | kg | |
|---|----------------------|----------------|-------------|------------------|--------------------|------------------|--------------------|--------------------|-------------------|---------------------|------------------|-------|-------|
| | | | | | | | | | | | | | |
| keylock switch 2 positions 45 - 70 mm standard lock B2 300, other lock numbers on re- quest | | 55 mm | 1 NC + 1 NO | M | - | A | 931-.401-00 | 25 | 24 | 8 | | 0,024 | |
| | | | | MA | - | A | 921-.401-00 | 24 | 24 | 8 | | 0,024 | |
| | | | | | - | A+C | 911-.401-00 | 24 | 24 | 8 | | 0,024 | |
| | | | 2 NC + 2 NO | M | - | A | 932-.401-00 | 23 | 24 | 8 | | 0,025 | |
| | | | | MA | - | A | 922-.401-00 | 22 | 24 | 8 | | 0,025 | |
| | | | | | - | A+C | 912-.401-00 | 22 | 24 | 8 | | 0,025 | |
| | | | 3 NC + 3 NO | M | - | A | 933-.401-00 | 27 | 24 | 8 | | 0,027 | |
| | | | | MA | - | A | 923-.401-00 | 26 | 24 | 8 | | 0,027 | |
| | | | | | - | A+C | 913-.401-00 | 26 | 24 | 8 | | 0,027 | |
| | | | 4 NC + 4 NO | M | - | A | 934-.401-00 | 29 | 24 | 8 | | 0,030 | |
| | | | | MA | - | A | 924-.401-00 | 28 | 24 | 8 | | 0,030 | |
| | | | | | - | A+C | 914-.401-00 | 28 | 24 | 8 | | 0,030 | |
| | | | 5 NC + 5 NO | M | - | A | 935-.401-00 | 31 | 24 | 8 | | 0,033 | |
| | | | | MA | - | A | 925-.401-00 | 30 | 24 | 8 | | 0,033 | |
| | | | | | - | A+C | 915-.401-00 | 30 | 24 | 8 | | 0,033 | |
| | | | 67 mm | 1 NC + 1 NO | M | P | A | 831-.401-0P | 25 | 25 | 8 | 1 | 0,026 |
| | | | | | MA | P | A | 821-.401-0P | 24 | 25 | 8 | 1 | 0,026 |
| | | | | | | P | A+C | 811-.401-0P | 24 | 25 | 8 | 1 | 0,026 |
| | | 2 NC + 2 NO | | M | P | A | 832-.401-0P | 23 | 25 | 8 | 1 | 0,027 | |
| | | | | MA | P | A | 822-.401-0P | 22 | 25 | 8 | 1 | 0,027 | |
| | | | | | P | A+C | 812-.401-0P | 22 | 25 | 8 | 1 | 0,027 | |
| | | 3 NC + 3 NO | | M | P | A | 833-.401-0P | 27 | 25 | 8 | 1 | 0,028 | |
| | | | | MA | P | A | 823-.401-0P | 26 | 25 | 8 | 1 | 0,028 | |
| | | | | | P | A+C | 813-.401-0P | 26 | 25 | 8 | 1 | 0,028 | |
| | | 4 NC + 4 NO | | M | P | A | 834-.401-0P | 29 | 25 | 8 | 1 | 0,031 | |
| | | | | MA | P | A | 824-.401-0P | 28 | 25 | 8 | 1 | 0,031 | |
| | | | | | P | A+C | 814-.401-0P | 28 | 25 | 8 | 1 | 0,031 | |
| | | 5 NC + 5 NO | | M | P | A | 835-.401-0P | 31 | 25 | 8 | 1 | 0,034 | |
| | | | | MA | P | A | 825-.401-0P | 30 | 25 | 8 | 1 | 0,034 | |
| | | | | | P | A+C | 815-.401-0P | 30 | 25 | 8 | 1 | 0,034 | |
| | | 70 mm | | 1 NC + 1 NO | M | - | A | 831-.401-00 | 25 | 26 | 8 | | 0,026 |
| | | | | | MA | - | A | 821-.401-00 | 24 | 26 | 8 | | 0,026 |
| | | | | | | - | A+C | 811-.401-00 | 24 | 26 | 8 | | 0,026 |
| | | | 2 NC + 2 NO | M | - | A | 832-.401-00 | 23 | 26 | 8 | | 0,027 | |
| | | | | MA | - | A | 822-.401-00 | 22 | 26 | 8 | | 0,027 | |
| | | | | | - | A+C | 812-.401-00 | 22 | 26 | 8 | | 0,027 | |
| 3 NC + 3 NO | M | | - | A | 833-.401-00 | 27 | 26 | 8 | | 0,029 | | | |
| | MA | | - | A | 823-.401-00 | 26 | 26 | 8 | | 0,029 | | | |
| | | | - | A+C | 813-.401-00 | 26 | 26 | 8 | | 0,029 | | | |
| 4 NC + 4 NO | M | | - | A | 834-.401-00 | 29 | 26 | 8 | | 0,032 | | | |
| | MA | | - | A | 824-.401-00 | 28 | 26 | 8 | | 0,032 | | | |
| | | | - | A+C | 814-.401-00 | 28 | 26 | 8 | | 0,032 | | | |
| 5 NC + 5 NO | M | | - | A | 835-.401-00 | 31 | 26 | 8 | | 0,035 | | | |
| | MA | | - | A | 825-.401-00 | 30 | 26 | 8 | | 0,035 | | | |
| | | | - | A+C | 815-.401-00 | 30 | 26 | 8 | | 0,035 | | | |

Continued on next page

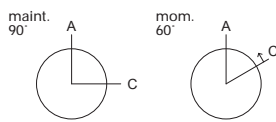

| | degree of protection | mounting depth | contacts | switching action | connection method | key removable in | part no. | circuit drawing | | technical drawing | | mounting dimensions | | component layout | |
|--|----------------------|----------------|-------------|------------------|-------------------|------------------|--------------------|--------------------|----|-------------------|---|---------------------|-------|------------------|--|
| | | | | | | | | | | | | | | | |
| keylock switch 2 positions 45 - 70 mm standard lock B2 300, other lock numbers on re- quest | IP 65 | 42 mm | 1 NC + 1 NO | M | P | A | 781-.401-WP | 21 | 21 | 9 | 1 | 0,022 | | | |
| | | | | MA | P | A | 771-.401-WP | 20 | 21 | 9 | 1 | 0,022 | | | |
| | | | | | | A+C | 761-.401-WP | 20 | 21 | 9 | 1 | 0,022 | | | |
| | | | 2 NC + 2 NO | M | P | A | 782-.401-WP | 23 | 21 | 9 | 1 | 0,023 | | | |
| | | | | MA | P | A | 772-.401-WP | 22 | 21 | 9 | 1 | 0,023 | | | |
| | | | | | | A+C | 762-.401-WP | 22 | 21 | 9 | 1 | 0,023 | | | |
| | | 45 mm | 1 NC + 1 NO | M | - | A | 781-.401-WO | 21 | 22 | 9 | | 0,022 | | | |
| | | | | MA | - | A | 771-.401-WO | 20 | 22 | 9 | | 0,022 | | | |
| | | | | | | A+C | 761-.401-WO | 20 | 22 | 9 | | 0,022 | | | |
| | | | 2 NC + 2 NO | M | - | A | 782-.401-WO | 23 | 22 | 9 | | 0,023 | | | |
| | | | | MA | - | A | 772-.401-WO | 22 | 22 | 9 | | 0,023 | | | |
| | | | | | | A+C | 762-.401-WO | 22 | 22 | 9 | | 0,023 | | | |
| | | 52 mm | 1 NC + 1 NO | M | P | A | 931-.401-WP | 25 | 23 | 9 | 1 | 0,024 | | | |
| | | | | MA | P | A | 921-.401-WP | 24 | 23 | 9 | 1 | 0,024 | | | |
| | | | | | | A+C | 911-.401-WP | 24 | 23 | 9 | 1 | 0,024 | | | |
| | | | 2 NC + 2 NO | M | P | A | 932-.401-WP | 23 | 23 | 9 | 1 | 0,025 | | | |
| | | | | MA | P | A | 922-.401-WP | 22 | 23 | 9 | 1 | 0,025 | | | |
| | | | | | | A+C | 912-.401-WP | 22 | 23 | 9 | 1 | 0,025 | | | |
| | | | 3 NC + 3 NO | M | P | A | 933-.401-WP | 27 | 23 | 9 | 1 | 0,026 | | | |
| | | | | MA | P | A | 923-.401-WP | 26 | 23 | 9 | 1 | 0,026 | | | |
| | | | | | | A+C | 913-.401-WP | 26 | 23 | 9 | 1 | 0,026 | | | |
| | | | 4 NC + 4 NO | M | P | A | 934-.401-WP | 29 | 23 | 9 | 1 | 0,029 | | | |
| | | | | MA | P | A | 924-.401-WP | 28 | 23 | 9 | 1 | 0,029 | | | |
| | | | | | | A+C | 914-.401-WP | 28 | 23 | 9 | 1 | 0,029 | | | |
| | | | 5 NC + 5 NO | M | P | A | 935-.401-WP | 31 | 23 | 9 | 1 | 0,032 | | | |
| | | | | MA | P | A | 925-.401-WP | 30 | 23 | 9 | 1 | 0,032 | | | |
| | | | | | | A+C | 915-.401-WP | 30 | 23 | 9 | 1 | 0,032 | | | |
| | | | 55 mm | 1 NC + 1 NO | M | - | A | 931-.401-WO | 25 | 24 | 9 | | 0,024 | | |
| | | | | | MA | - | A | 921-.401-WO | 24 | 24 | 9 | | 0,024 | | |
| | | | | | | | A+C | 911-.401-WO | 24 | 24 | 9 | | 0,024 | | |
| | | 2 NC + 2 NO | | M | - | A | 932-.401-WO | 23 | 24 | 9 | | 0,025 | | | |
| | | | | MA | - | A | 922-.401-WO | 22 | 24 | 9 | | 0,025 | | | |
| | | | | | | A+C | 912-.401-WO | 22 | 24 | 9 | | 0,025 | | | |
| | | 3 NC + 3 NO | | M | - | A | 933-.401-WO | 27 | 24 | 9 | | 0,027 | | | |
| | | | | MA | - | A | 923-.401-WO | 26 | 24 | 9 | | 0,027 | | | |
| | | | | | | A+C | 913-.401-WO | 26 | 24 | 9 | | 0,027 | | | |
| | | 4 NC + 4 NO | | M | - | A | 934-.401-WO | 29 | 24 | 9 | | 0,030 | | | |
| | | | | MA | - | A | 924-.401-WO | 28 | 24 | 9 | | 0,030 | | | |
| | | | | | | A+C | 914-.401-WO | 28 | 24 | 9 | | 0,030 | | | |
| | | 5 NC + 5 NO | | M | - | A | 935-.401-WO | 31 | 24 | 9 | | 0,033 | | | |
| | | | | MA | - | A | 925-.401-WO | 30 | 24 | 9 | | 0,033 | | | |
| | | | | | | A+C | 915-.401-WO | 30 | 24 | 9 | | 0,033 | | | |

Continued on next page

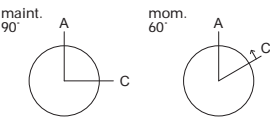

| keylock switch 2 positions 45 - 70 mm standard lock B2 300, other lock numbers on re- quest | degree of protec- tion | mounting depth | contacts | switching action | connection method | key removable in | part no. | circuit drawing | technical drawing | mounting dimensions | component layout | kg/H | |
|---|---------------------------|-------------------|-------------|--------------------|-------------------|------------------------|--------------------|--------------------|-------------------|---------------------|------------------|-------|-------|
| | | | | | | | | | | | | | |
| | | 67 mm | 1 NC + 1 NO | M | P | A | 831-.401-WP | 25 | 25 | 9 | 1 | 0,026 | |
| | | | | MA | P | A | 821-.401-WP | 24 | 25 | 9 | 1 | 0,026 | |
| | | | | | | A+C | 811-.401-WP | 24 | 25 | 9 | 1 | 0,026 | |
| | | | 2 NC + 2 NO | M | P | A | 832-.401-WP | 23 | 25 | 9 | 1 | 0,027 | |
| | | | | MA | P | A | 822-.401-WP | 22 | 25 | 9 | 1 | 0,027 | |
| | | | | | | A+C | 812-.401-WP | 22 | 25 | 9 | 1 | 0,027 | |
| | | | 3 NC + 3 NO | M | P | A | 833-.401-WP | 27 | 25 | 9 | 1 | 0,028 | |
| | | | | MA | P | A | 823-.401-WP | 26 | 25 | 9 | 1 | 0,028 | |
| | | | | | | A+C | 813-.401-WP | 26 | 25 | 9 | 1 | 0,028 | |
| | | | 4 NC + 4 NO | M | P | A | 834-.401-WP | 29 | 25 | 9 | 1 | 0,031 | |
| | | | | MA | P | A | 824-.401-WP | 28 | 25 | 9 | 1 | 0,031 | |
| | | | | | | A+C | 814-.401-WP | 28 | 25 | 9 | 1 | 0,031 | |
| | | 5 NC + 5 NO | M | P | A | 835-.401-WP | 31 | 25 | 9 | 1 | 0,034 | | |
| | | | MA | P | A | 825-.401-WP | 30 | 25 | 9 | 1 | 0,034 | | |
| | | | | | A+C | 815-.401-WP | 30 | 25 | 9 | 1 | 0,034 | | |
| | | 70 mm | | 1 NC + 1 NO | M | - | A | 831-.401-WO | 25 | 26 | 9 | | 0,026 |
| | | | | | MA | - | A | 821-.401-WO | 24 | 26 | 9 | | 0,026 |
| | | | | | | | A+C | 811-.401-WO | 24 | 26 | 9 | | 0,026 |
| | | | | 2 NC + 2 NO | M | - | A | 832-.401-WO | 23 | 26 | 9 | | 0,027 |
| | | | | | MA | - | A | 822-.401-WO | 22 | 26 | 9 | | 0,027 |
| | | | | | | | A+C | 812-.401-WO | 22 | 26 | 9 | | 0,027 |
| | | | | 3 NC + 3 NO | M | - | A | 833-.401-WO | 27 | 26 | 9 | | 0,029 |
| | | | | | MA | - | A | 823-.401-WO | 26 | 26 | 9 | | 0,029 |
| | | | | | | | A+C | 813-.401-WO | 26 | 26 | 9 | | 0,029 |
| 4 NC + 4 NO | M | | | - | A | 834-.401-WO | 29 | 26 | 9 | | 0,032 | | |
| | MA | | | - | A | 824-.401-WO | 28 | 26 | 9 | | 0,032 | | |
| | | | | | A+C | 814-.401-WO | 28 | 26 | 9 | | 0,032 | | |
| 5 NC + 5 NO | M | - | A | 835-.401-WO | 31 | 26 | 9 | | 0,035 | | | | |
| | MA | - | A | 825-.401-WO | 30 | 26 | 9 | | 0,035 | | | | |
| | | | A+C | 815-.401-WO | 30 | 26 | 9 | | 0,035 | | | | |

contacts : normally closed = NC, normally open = NO

switching action : maintained action = MA, momentary action = M

connection method : PCB terminal = P, soldering-/plug-in terminal = -

other key removable combination on request

hint:

- we recommend to use location strip no. 260-0020-00 for anti-twisting of the front bezel.

- at momentary position the overturning force is max. 60 Ncm.

circuit drawings from page 657, technical drawings from page 642, mounting dimensions from page 652, component layouts from page 657

keylock switch 3 positions 45 mm



front cap for keylock-/selector switch 3 positions page 626

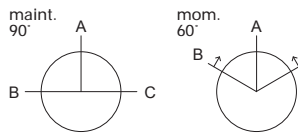

| | degree of protection | mounting depth | contacts | switching action | connection method | key removable in | part no. | circuit drawing | technical drawing | mounting dimensions | component layout | |
|--|----------------------|----------------|-------------|------------------|-------------------|--------------------|--------------------|-----------------|-------------------|---------------------|------------------|-------|
| keylock switch 3 positions 45 mm standard lock B2 300, other lock numbers on request | IP 40 | 42 mm | 2 NC + 2 NO | 0 - MA - MA | P | B+A+C | 722-.401-0P | 32 | 21 | 8 | 1 | 0,023 |
| | | | | M - 0 - M | P | A | 732-.401-0P | 33 | 21 | 8 | 1 | 0,023 |
| | | | | M - 0 - MA | P | A+C | 752-.401-0P | 35 | 21 | 8 | 1 | 0,023 |
| | | | | MA - 0 - M | P | B+A | 742-.401-0P | 34 | 21 | 8 | 1 | 0,023 |
| | | | | MA - 0 - MA | P | B+A+C | 712-.401-0P | 32 | 21 | 8 | 1 | 0,023 |
| | | 45 mm | 2 NC + 2 NO | 0 - MA - MA | - | B+A+C | 722-.401-00 | 32 | 22 | 8 | | 0,023 |
| | | | | M - 0 - M | - | A | 732-.401-00 | 33 | 22 | 8 | | 0,023 |
| | | | | M - 0 - MA | - | A+C | 752-.401-00 | 35 | 22 | 8 | | 0,023 |
| | | | | MA - 0 - M | - | B+A | 742-.401-00 | 34 | 22 | 8 | | 0,023 |
| | | | | MA - 0 - MA | - | B+A+C | 712-.401-00 | 32 | 22 | 8 | | 0,023 |
| | IP 65 | 42 mm | 2 NC + 2 NO | 0 - MA - MA | P | B+A+C | 722-.401-WP | 32 | 21 | 9 | 1 | 0,023 |
| | | | | M - 0 - M | P | A | 732-.401-WP | 33 | 21 | 9 | 1 | 0,023 |
| | | | | M - 0 - MA | P | A+C | 752-.401-WP | 35 | 21 | 9 | 1 | 0,023 |
| | | | | MA - 0 - M | P | B+A | 742-.401-WP | 34 | 21 | 9 | 1 | 0,023 |
| | | | | MA - 0 - MA | P | B+A+C | 712-.401-WP | 32 | 21 | 9 | 1 | 0,023 |
| | | 45 mm | 2 NC + 2 NO | 0 - MA - MA | - | B+A+C | 722-.401-W0 | 32 | 22 | 9 | | 0,023 |
| M - 0 - M | | | | - | A | 732-.401-W0 | 33 | 22 | 9 | | 0,023 | |
| M - 0 - MA | | | | - | A+C | 752-.401-W0 | 35 | 22 | 9 | | 0,023 | |
| MA - 0 - M | | | | - | B+A | 742-.401-W0 | 34 | 22 | 9 | | 0,023 | |
| MA - 0 - MA | | | | - | B+A+C | 712-.401-W0 | 32 | 22 | 9 | | 0,023 | |

contacts : normally closed = NC, normally open = NO

switching action: maintained action = MA, momentary action = M

connection method : PCB terminal = P, soldering-/plug-in terminal = -

other key removable combination on request

hint:

- we recommend to use location strip no. 260-0020-00 for anti-twisting of the front bezel.

- at momentary position the overturning force is max. 60 Ncm.

circuit drawings from page 657, technical drawings from page 642, mounting dimensions from page 652, component layouts from page 657

selector switch 2 positions 45 - 70 mm



🛒 front cap for keylock-/selector switch 2 positions page 625

🛒 lever page 627

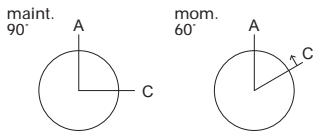

| selector switch 2 positions 45 - 70 mm | degree of protection | mounting depth | contacts | switching action | connection method | part no. | circuit drawing | technical drawing | mounting dimensions | component layout | 📄 | |
|---|----------------------|----------------|-------------|------------------|-------------------|--------------------|--------------------|-------------------|---------------------|------------------|-------|-------|
| | | | | | | | | | | | | |
| selector switch 2 positions 45 - 70 mm | IP 40 | 42 mm | 1 NC + 1 NO | M | P | 781-.700-0P | 37 | 27 | 10 | 1 | 0,011 | |
| | | | | MA | P | 761-.700-0P | 36 | 27 | 10 | 1 | 0,011 | |
| | | | 2 NC + 2 NO | M | P | 782-.700-0P | 39 | 27 | 10 | 1 | 0,012 | |
| | | | | MA | P | 762-.700-0P | 38 | 27 | 10 | 1 | 0,012 | |
| | | 45 mm | 1 NC + 1 NO | M | - | 781-.700-00 | 37 | 28 | 10 | | 0,011 | |
| | | | | MA | - | 761-.700-00 | 36 | 28 | 10 | | 0,011 | |
| | | | 2 NC + 2 NO | M | - | 782-.700-00 | 39 | 28 | 10 | | 0,012 | |
| | | | | MA | - | 762-.700-00 | 38 | 28 | 10 | | 0,012 | |
| | | | 52 mm | 1 NC + 1 NO | M | P | 931-.700-0P | 41 | 29 | 10 | 1 | 0,013 |
| | | | | | MA | P | 911-.700-0P | 40 | 29 | 10 | 1 | 0,013 |
| | | 2 NC + 2 NO | | M | P | 932-.700-0P | 39 | 29 | 10 | 1 | 0,014 | |
| | | | | MA | P | 912-.700-0P | 38 | 29 | 10 | 1 | 0,014 | |
| | | 3 NC + 3 NO | | M | P | 933-.700-0P | 43 | 29 | 10 | 1 | 0,015 | |
| | | | | MA | P | 913-.700-0P | 42 | 29 | 10 | 1 | 0,015 | |
| | | 4 NC + 4 NO | | M | P | 934-.700-0P | 45 | 29 | 10 | 1 | 0,018 | |
| | | | | MA | P | 914-.700-0P | 44 | 29 | 10 | 1 | 0,018 | |
| | | 5 NC + 5 NO | | M | P | 935-.700-0P | 47 | 29 | 10 | 1 | 0,022 | |
| | | | | MA | P | 915-.700-0P | 46 | 29 | 10 | 1 | 0,022 | |
| | | 55 mm | 1 NC + 1 NO | M | - | 931-.700-00 | 41 | 30 | 10 | | 0,013 | |
| | | | | MA | - | 911-.700-00 | 40 | 30 | 10 | | 0,013 | |
| | | | 2 NC + 2 NO | M | - | 932-.700-00 | 39 | 30 | 10 | | 0,014 | |
| | | | | MA | - | 912-.700-00 | 38 | 30 | 10 | | 0,014 | |
| | | | 3 NC + 3 NO | M | - | 933-.700-00 | 43 | 30 | 10 | | 0,015 | |
| | | | | MA | - | 913-.700-00 | 42 | 30 | 10 | | 0,015 | |
| | | | 4 NC + 4 NO | M | - | 934-.700-00 | 45 | 30 | 10 | | 0,019 | |
| | | | | MA | - | 914-.700-00 | 44 | 30 | 10 | | 0,019 | |
| | | | 5 NC + 5 NO | M | - | 935-.700-00 | 47 | 30 | 10 | | 0,023 | |
| | | | | MA | - | 915-.700-00 | 46 | 30 | 10 | | 0,023 | |
| | | 67 mm | 1 NC + 1 NO | M | P | 831-.700-0P | 41 | 31 | 10 | 1 | 0,015 | |
| | | | | MA | P | 811-.700-0P | 40 | 31 | 10 | 1 | 0,015 | |
| | | | 2 NC + 2 NO | M | P | 832-.700-0P | 39 | 31 | 10 | 1 | 0,016 | |
| | | | | MA | P | 812-.700-0P | 38 | 31 | 10 | 1 | 0,016 | |
| | | | 3 NC + 3 NO | M | P | 833-.700-0P | 43 | 31 | 10 | 1 | 0,017 | |
| | | | | MA | P | 813-.700-0P | 42 | 31 | 10 | 1 | 0,017 | |
| | | | 4 NC + 4 NO | M | P | 834-.700-0P | 45 | 31 | 10 | 1 | 0,020 | |
| | | | | MA | P | 814-.700-0P | 44 | 31 | 10 | 1 | 0,020 | |
| | | | 5 NC + 5 NO | M | P | 835-.700-0P | 47 | 31 | 10 | 1 | 0,024 | |
| | | | | MA | P | 815-.700-0P | 46 | 31 | 10 | 1 | 0,024 | |

Continued on next page

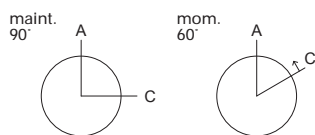

| | degree of protection | mounting depth | contacts | switching action | connection method | part no. | circuit drawing | technical drawing | mounting dimensions | component layout | (mm) | | |
|--|----------------------|----------------|-------------|--------------------|--------------------|--------------------|--------------------|--------------------|---------------------|------------------|-------|-------|-------|
| selector switch 2 positions 45 - 70 mm | IP 40 | 70 mm | 1 NC + 1 NO | M | - | 831-.700-00 | 41 | 32 | 10 | | 0,015 | | |
| | | | | MA | - | 811-.700-00 | 40 | 32 | 10 | | 0,015 | | |
| | | | 2 NC + 2 NO | M | - | 832-.700-00 | 39 | 32 | 10 | | 0,016 | | |
| | | | | MA | - | 812-.700-00 | 38 | 32 | 10 | | 0,016 | | |
| | | | 3 NC + 3 NO | M | - | 833-.700-00 | 43 | 32 | 10 | | 0,017 | | |
| | | | | MA | - | 813-.700-00 | 42 | 32 | 10 | | 0,017 | | |
| | | | 4 NC + 4 NO | M | - | 834-.700-00 | 45 | 32 | 10 | | 0,021 | | |
| | | | | MA | - | 814-.700-00 | 44 | 32 | 10 | | 0,021 | | |
| | | | 5 NC + 5 NO | M | - | 835-.700-00 | 47 | 32 | 10 | | 0,025 | | |
| | | | | MA | - | 815-.700-00 | 46 | 32 | 10 | | 0,025 | | |
| | | | IP 65 | 42 mm | 1 NC + 1 NO | M | P | 781-.700-WP | 37 | 27 | 11 | 1 | 0,011 |
| | | | | | | MA | P | 761-.700-WP | 36 | 27 | 11 | 1 | 0,011 |
| | 2 NC + 2 NO | M | | | P | 782-.700-WP | 39 | 27 | 11 | 1 | 0,012 | | |
| | | MA | | | P | 762-.700-WP | 38 | 27 | 11 | 1 | 0,012 | | |
| | 45 mm | 1 NC + 1 NO | | | M | - | 781-.700-W0 | 37 | 28 | 11 | | 0,011 | |
| | | | | | MA | - | 761-.700-W0 | 36 | 28 | 11 | | 0,011 | |
| | | 2 NC + 2 NO | | | M | - | 782-.700-W0 | 39 | 28 | 11 | | 0,012 | |
| | | | | | MA | - | 762-.700-W0 | 38 | 28 | 11 | | 0,012 | |
| | 52 mm | 1 NC + 1 NO | | | M | P | 931-.700-WP | 41 | 29 | 11 | 1 | 0,013 | |
| | | | | | MA | P | 911-.700-WP | 40 | 29 | 11 | 1 | 0,013 | |
| | | 2 NC + 2 NO | | | M | P | 932-.700-WP | 39 | 29 | 11 | 1 | 0,014 | |
| | | | | | MA | P | 912-.700-WP | 38 | 29 | 11 | 1 | 0,014 | |
| | | 3 NC + 3 NO | | M | P | 933-.700-WP | 43 | 29 | 11 | 1 | 0,015 | | |
| | | | | MA | P | 913-.700-WP | 42 | 29 | 11 | 1 | 0,015 | | |
| 4 NC + 4 NO | | M | | P | 934-.700-WP | 45 | 29 | 11 | 1 | 0,018 | | | |
| | | MA | | P | 914-.700-WP | 44 | 29 | 11 | 1 | 0,018 | | | |
| 5 NC + 5 NO | | M | | P | 935-.700-WP | 47 | 29 | 11 | 1 | 0,022 | | | |
| | | MA | | P | 915-.700-WP | 46 | 29 | 11 | 1 | 0,022 | | | |
| 55 mm | | 1 NC + 1 NO | | M | - | 931-.700-W0 | 41 | 30 | 11 | | 0,013 | | |
| | | | | MA | - | 911-.700-W0 | 40 | 30 | 11 | | 0,013 | | |
| | 2 NC + 2 NO | M | | - | 932-.700-W0 | 39 | 30 | 11 | | 0,014 | | | |
| | | MA | | - | 912-.700-W0 | 38 | 30 | 11 | | 0,014 | | | |
| | 3 NC + 3 NO | M | | - | 933-.700-W0 | 43 | 30 | 11 | | 0,015 | | | |
| | | MA | | - | 913-.700-W0 | 42 | 30 | 11 | | 0,015 | | | |
| | 4 NC + 4 NO | M | | - | 934-.700-W0 | 45 | 30 | 11 | | 0,019 | | | |
| | | MA | | - | 914-.700-W0 | 44 | 30 | 11 | | 0,019 | | | |
| | 5 NC + 5 NO | M | | - | 935-.700-W0 | 47 | 30 | 11 | | 0,023 | | | |
| | | MA | | - | 915-.700-W0 | 46 | 30 | 11 | | 0,023 | | | |
| | 67 mm | 1 NC + 1 NO | | M | P | 831-.700-WP | 41 | 31 | 11 | 1 | 0,015 | | |
| | | | | MA | P | 811-.700-WP | 40 | 31 | 11 | 1 | 0,015 | | |
| 2 NC + 2 NO | | M | | P | 832-.700-WP | 39 | 31 | 11 | 1 | 0,016 | | | |
| | | MA | | P | 812-.700-WP | 38 | 31 | 11 | 1 | 0,016 | | | |
| 3 NC + 3 NO | | M | | P | 833-.700-WP | 43 | 31 | 11 | 1 | 0,017 | | | |
| | | MA | | P | 813-.700-WP | 42 | 31 | 11 | 1 | 0,017 | | | |
| 4 NC + 4 NO | | M | | P | 834-.700-WP | 45 | 31 | 11 | 1 | 0,020 | | | |
| | | MA | | P | 814-.700-WP | 44 | 31 | 11 | 1 | 0,020 | | | |
| 5 NC + 5 NO | | M | P | 835-.700-WP | 47 | 31 | 11 | 1 | 0,024 | | | | |
| | | MA | P | 815-.700-WP | 46 | 31 | 11 | 1 | 0,024 | | | | |

Continued on next page

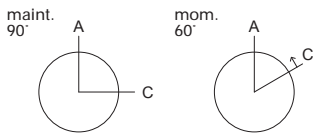

| | degree of protection | mounting depth | contacts | switching action | connection method | part no. | circuit drawing | technical drawing | mounting dimensions | component layout | |
|--|----------------------|----------------|-------------|------------------|-------------------|--------------------|-----------------|-------------------|---------------------|------------------|-------|
| selector switch 2 positions 45 - 70 mm | IP 65 | 70 mm | 1 NC + 1 NO | M | - | 831-.700-W0 | 41 | 32 | 11 | | 0,015 |
| | | | | MA | - | 811-.700-W0 | 40 | 32 | 11 | | 0,015 |
| | | | 2 NC + 2 NO | M | - | 832-.700-W0 | 39 | 32 | 11 | | 0,016 |
| | | | | MA | - | 812-.700-W0 | 38 | 32 | 11 | | 0,016 |
| | | | 3 NC + 3 NO | M | - | 833-.700-W0 | 43 | 32 | 11 | | 0,017 |
| | | | | MA | - | 813-.700-W0 | 42 | 32 | 11 | | 0,017 |
| | | | 4 NC + 4 NO | M | - | 834-.700-W0 | 45 | 32 | 11 | | 0,021 |
| | | | | MA | - | 814-.700-W0 | 44 | 32 | 11 | | 0,021 |
| | | | 5 NC + 5 NO | M | - | 835-.700-W0 | 47 | 32 | 11 | | 0,025 |
| | | | | MA | - | 815-.700-W0 | 46 | 32 | 11 | | 0,025 |

contacts : normally closed = NC, normally open = NO

switching action : maintained action = MA, momentary action = M

connection method : PCB terminal = P, soldering-/plug-in terminal = -

hint:

- we recommend to use location strip no. 260-0020-00 for anti-twisting of the front bezel.

- at momentary position the overturning force is max. 60 Ncm.

circuit drawings from page 657, technical drawings from page 642, mounting dimensions from page 652, component layouts from page 657

selector switch 3 positions 45 mm



☞ front cap for keylock-/selector switch 3 positions page 626

☞ lever page 627

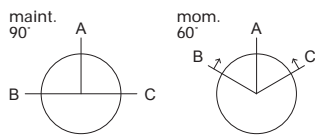

| | degree of protection | mounting depth | contacts | switching action | connection method | part no. | circuit drawing | technical drawing | mounting dimensions | component layout | |
|--|----------------------|----------------|-------------|------------------|-------------------|--------------------|-----------------|-------------------|---------------------|------------------|-------|
| selector switch 3 positions 45 mm | IP 40 | 42 mm | 2 NC + 2 NO | 0 - MA - MA | P | 722-.700-0P | 48 | 27 | 10 | 1 | 0,012 |
| | | | | M - 0 - M | P | 732-.700-0P | 49 | 27 | 10 | 1 | 0,012 |
| | | | | M - 0 - MA | P | 752-.700-0P | 51 | 27 | 10 | 1 | 0,012 |
| | | | | MA - 0 - M | P | 742-.700-0P | 50 | 27 | 10 | 1 | 0,012 |
| | | | | MA - 0 - MA | P | 712-.700-0P | 48 | 27 | 10 | 1 | 0,012 |
| | | 45 mm | 2 NC + 2 NO | 0 - MA - MA | - | 722-.700-00 | 48 | 28 | 10 | | 0,012 |
| | | | | M - 0 - M | - | 732-.700-00 | 49 | 28 | 10 | | 0,012 |
| | | | | M - 0 - MA | - | 752-.700-00 | 51 | 28 | 10 | | 0,012 |
| | | | | MA - 0 - M | - | 742-.700-00 | 50 | 28 | 10 | | 0,012 |
| | | | | MA - 0 - MA | - | 712-.700-00 | 48 | 28 | 10 | | 0,012 |
| | IP 65 | 42 mm | 2 NC + 2 NO | 0 - MA - MA | P | 722-.700-WP | 48 | 27 | 11 | 1 | 0,012 |
| | | | | M - 0 - M | P | 732-.700-WP | 49 | 27 | 11 | 1 | 0,012 |
| | | | | M - 0 - MA | P | 752-.700-WP | 51 | 27 | 11 | 1 | 0,012 |
| | | | | MA - 0 - M | P | 742-.700-WP | 50 | 27 | 11 | 1 | 0,012 |
| | | | | MA - 0 - MA | P | 712-.700-WP | 48 | 27 | 11 | 1 | 0,012 |
| | | 45 mm | 2 NC + 2 NO | 0 - MA - MA | - | 722-.700-W0 | 48 | 28 | 11 | | 0,012 |
| | | | | M - 0 - M | - | 732-.700-W0 | 49 | 28 | 11 | | 0,012 |
| | | | | M - 0 - MA | - | 752-.700-W0 | 51 | 28 | 11 | | 0,012 |
| | | | | MA - 0 - M | - | 742-.700-W0 | 50 | 28 | 11 | | 0,012 |
| | | | | MA - 0 - MA | - | 712-.700-W0 | 48 | 28 | 11 | | 0,012 |

contacts : normally closed = NC, normally open = NO

switching action: maintained action = MA, momentary action = M

connection method : PCB terminal = P, soldering-/plug-in terminal = -

hint:

- we recommend to use location strip no. 260-0020-00 for anti-twisting of the front bezel.

- at momentary position the overturning force is max. 60 Ncm.

circuit drawings from page 657, technical drawings from page 642, mounting dimensions from page 652, component layouts from page 657

buzzer 30 - 55 mm



🛒 buzzer element page 627

🛒 front bezel for buzzer 30 - 55 mm page 628

| | degree of protection | mounting depth | connection method | buzzer socket | part no. | circuit drawing | technical drawing | mounting dimensions | component layout | |
|--------------------------|----------------------|----------------|-------------------|---------------|-------------------|-----------------|-------------------|---------------------|------------------|-------|
| buzzer 30 - 55 mm | IP 40 | 30 mm | - | MG T 1 3/4 | 970-000-K0 | 52 | 2 | 12 | | 0,004 |
| | | 52 mm | P | MG T 1 3/4 | 970-000-0P | 52 | 4 | 12 | 1 | 0,007 |
| | | 55 mm | - | MG T 1 3/4 | 970-000-00 | 52 | 5 | 12 | | 0,007 |

connection method : soldering-/plug-in terminal = -, PCB terminal = P

the buzzer 55 mm is as long as the corresponding illuminated pushbutton and fits to the PCB plug-in base and multi plug housing

circuit drawings from page 657, technical drawings from page 642, mounting dimensions from page 652, component layouts from page 657

push-pull illuminated switch 45 mm



🛒 push-pull knob page 627

🛒 filament lamp MG T 1 3/4 page 634

🛒 LED MG T 1 3/4 page 634

| | mounting depth | contacts | switching action | connection method | colour of front bezel | 18 mm dia. Typ-Nr. | circuit drawing | technical drawing | mounting dimensions | component layout | |
|---|----------------|-------------|------------------|-------------------|-----------------------|--------------------|-----------------|-------------------|---------------------|------------------|-------|
| push-pull illuminated switch 45 mm IP 40, lampholder MG T 1 3/4 | 42 mm | 2 NC + 2 NO | M - 0 - M | P | grey | 792-1000-0P | 53 | 33 | 13 | 1 | 0,015 |
| | | | | | black | 792-2000-0P | 53 | 33 | 13 | 1 | 0,015 |
| | 45 mm | 2 NC + 2 NO | M - 0 - M | - | grey | 792-1000-00 | 53 | 34 | 13 | | 0,015 |
| | | | | | black | 792-2000-00 | 53 | 34 | 13 | | 0,015 |

contacts : normally closed = NC, normally open = NO

switching action: maintained action = MA, momentary action = M

connection method : PCB terminal = P, soldering-/plug-in terminal = -

circuit drawings from page 657, technical drawings from page 642, mounting dimensions from page 652, component layouts from page 657

indicator actuator 41-44 mm for flush mounting



- 🛒 lens for 35 mm page 622
- 🛒 front bezel-set for flush mounting page 628
- 🛒 filament lamp MG T 1 3/4 page 634
- 🛒 LED MG T 1 3/4 page 634
- 🛒 lamp element block for 35 mm page 632

| | degree of protection | a 24 x 30 mm part no. | b 24 x 24 mm part no. | 25 mm dia. part no. | circuit drawing | technical drawing | mounting dimension | components layout | |
|---|----------------------|-----------------------------|-----------------------------|------------------------|-----------------|-------------------|--------------------|-------------------|-------|
| indicator actuator 41-44 mm for flush mounting lamp socket MG T 1 3/4 | IP 40 | 690-6000-00 | 690-4000-00 | 690-2000-00 | 1 | 35 | 14 | - | 0,004 |
| | IP 65 | 690-6000-W0 | 690-4000-W0 | 690-2000-W0 | 1 | 35 | 14 | - | 0,005 |

circuit drawings from page 657, technical drawings from page 642, mounting dimensions from page 652

indicator for flush mounting 39 - 79 mm

protection degree IP 40



- 🛒 lens page 623
- 🛒 front bezel for indicator 39 - 79 mm page 627
- 🛒 front bezel-set for flush mounting page 628
- 🛒 filament lamp MG T 1 3/4 page 634
- 🛒 LED MG T 1 3/4 page 634
- 🛒 filament lamp T 5.5 page 634
- 🛒 LED T 5.5 page 635

| | mounting depth | connection method | lamp socket | part no. | circuit drawing | technical drawing | mounting dimensions | component layout | |
|--|----------------|-------------------|-------------|--------------------|-----------------|-------------------|---------------------|------------------|-------|
| indicator for flush mounting 39 - 79 mm | 39 mm | - | MG T 1 3/4 | 990-.000-K0 | 1 | 36 | 14 | | 0,004 |
| | 54 mm | - | T 5.5 | 890-.000-K0 | 1 | 37 | 14 | | 0,006 |
| | 61 mm | P | MG T 1 3/4 | 990-.000-0P | 1 | 38 | 14 | 1 | 0,007 |
| | 64 mm | - | MG T 1 3/4 | 990-.000-00 | 1 | 39 | 14 | | 0,007 |
| | 76 mm | P | T 5.5 | 890-.000-0P | 1 | 40 | 14 | 1 | 0,010 |
| | 79 mm | - | T 5.5 | 890-.000-00 | 1 | 41 | 14 | | 0,010 |

connection method : soldering-/plug-in terminal = -, PCB terminal = P

The indicators 55 mm and 70 mm are as long as the corresponding illuminated pushbuttons and fit to the PCB plug-in base and multi-plug housing. circuit drawings from page 657, technical drawings from page 642, mounting dimensions from page 652, component layouts from page 657

illuminated-/pushbutton actuator 41-44 mm for flush mounting



- ☞ lens page 623
- ☞ filament lamp MG T 1 3/4 page 634
- ☞ LED MG T 1 3/4 page 634
- ☞ snap-action switching element block for 35 mm page 631

| | degree of protection | switching action | component layout | | 25 mm dia. Typ-Nr. | circuit drawing | | | technical drawing | | | mounting dimensions |
|---|----------------------|------------------|----------------------------|----------------------------|-----------------------|-----------------|----|-------|-------------------|--|--|---------------------|
| | | | □ 24 x 30 mm Typ-Nr. | ⌀ 24 x 24 mm Typ-Nr. | | | | | | | | |
| illuminated-/pushbutton actuator 41-44 mm for flush mounting | IP 40 | M | | | 680-2000-00 | 54 | 35 | 14 | 0,004 | | | |
| | | | | 680-4000-00 | | 54 | 35 | 14 | 0,004 | | | |
| | | | 680-6000-00 | | 54 | 35 | 14 | 0,004 | | | | |
| | | MA (M) | | 600-2000-00 | 55 | 35 | 14 | 0,004 | | | | |
| | | | | 600-4000-00 | 55 | 35 | 14 | 0,004 | | | | |
| | | | 600-6000-00 | | 55 | 35 | 14 | 0,004 | | | | |
| | IP 65 | M | | | 680-2000-W0 | 54 | 35 | 14 | 0,005 | | | |
| | | | | 680-4000-W0 | | 54 | 35 | 14 | 0,005 | | | |
| | | | 680-6000-W0 | | 54 | 35 | 14 | 0,005 | | | | |
| | | MA (M) | | 600-2000-W0 | 55 | 35 | 14 | 0,005 | | | | |
| | | | | 600-4000-W0 | 55 | 35 | 14 | 0,005 | | | | |
| | | | 600-6000-W0 | | 55 | 35 | 14 | 0,005 | | | | |

switching action : momentary action = M, maintained action = MA

circuit drawings from page 657, technical drawings from page 642, mounting dimensions from page 652

pushbutton-/illuminated pushbutton for flush mounting 61 - 79 mm

protection degree IP 40



- 🛒 lens page 623
- 🛒 front bezel for illuminated-/pushbutton 61 - 79 mm page 627
- 🛒 front bezel-set for flush mounting page 628
- 🛒 filament lamp MG T 1 3/4 page 634
- 🛒 LED MG T 1 3/4 page 634
- 🛒 filament lamp T 5.5 page 634
- 🛒 LED T 5.5 page 635

| | mounting depth | contacts | switching action | connection method | lamp socket | part no. | circuit drawing | technical drawing | mounting dimensions | component layout | |
|---|----------------|-------------|------------------|-------------------|-------------|-------------------|-----------------|-------------------|---------------------|------------------|-------|
| pushbutton-/illuminated pushbutton for flush mounting 61 - 79 mm | 61 mm | 1 NC + 1 NO | maintained | P | MG T 1 3/4 | 901-000-0P | 4 | 42 | 14 | 1 | 0,013 |
| | | 2 NC + 2 NO | maintained | P | MG T 1 3/4 | 902-000-0P | 5 | 42 | 14 | 1 | 0,014 |
| | | 3 NC + 3 NO | maintained | P | MG T 1 3/4 | 903-000-0P | 6 | 42 | 14 | 1 | 0,014 |
| | | 4 NC + 4 NO | maintained | P | MG T 1 3/4 | 904-000-0P | 7 | 42 | 14 | 1 | 0,018 |
| | | 5 NC + 5 NO | maintained | P | MG T 1 3/4 | 905-000-0P | 8 | 42 | 14 | 1 | 0,021 |
| | 64 mm | 1 NC + 1 NO | maintained | - | MG T 1 3/4 | 901-000-00 | 4 | 43 | 14 | | 0,013 |
| | | 2 NC + 2 NO | maintained | - | MG T 1 3/4 | 902-000-00 | 5 | 43 | 14 | | 0,014 |
| | | 3 NC + 3 NO | maintained | - | MG T 1 3/4 | 903-000-00 | 6 | 43 | 14 | | 0,015 |
| | | 4 NC + 4 NO | maintained | - | MG T 1 3/4 | 904-000-00 | 7 | 43 | 14 | | 0,019 |
| | | 5 NC + 5 NO | maintained | - | MG T 1 3/4 | 905-000-00 | 8 | 43 | 14 | | 0,022 |
| | 76 mm | 1 NC + 1 NO | maintained | P | T 5.5 | 801-000-0P | 4 | 44 | 14 | 1 | 0,015 |
| | | 2 NC + 2 NO | maintained | P | T 5.5 | 802-000-0P | 5 | 44 | 14 | 1 | 0,016 |
| | | 3 NC + 3 NO | maintained | P | T 5.5 | 803-000-0P | 6 | 44 | 14 | 1 | 0,014 |
| | | 4 NC + 4 NO | maintained | P | T 5.5 | 804-000-0P | 7 | 44 | 14 | 1 | 0,020 |
| | | 5 NC + 5 NO | maintained | P | T 5.5 | 805-000-0P | 8 | 44 | 14 | 1 | 0,023 |
| | 79 mm | 1 NC + 1 NO | maintained | - | T 5.5 | 801-000-00 | 4 | 45 | 14 | | 0,015 |
| | | 2 NC + 2 NO | maintained | - | T 5.5 | 802-000-00 | 5 | 45 | 14 | | 0,016 |
| | | 3 NC + 3 NO | maintained | - | T 5.5 | 803-000-00 | 6 | 45 | 14 | | 0,017 |
| | | 4 NC + 4 NO | maintained | - | T 5.5 | 804-000-00 | 7 | 45 | 14 | | 0,021 |
| | | 5 NC + 5 NO | maintained | - | T 5.5 | 805-000-00 | 8 | 45 | 14 | | 0,024 |

contacts : normally closed = NC, normally open = NO

switching action: (changeable to momentary, reversible)

connection method : PCB terminal = P, soldering-/plug-in terminal = -

circuit drawings from page 657, technical drawings from page 642, mounting dimensions from page 652, component layouts from page 657

keylock switch 2 positions for flush mounting 51 - 79 mm



☞ front cap for keylock-/selector switch 2 positions page 625

☞ front bezel-set for flush mounting page 628

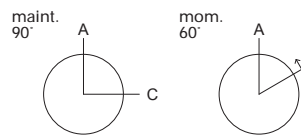

| | degree of protection | mounting depth | contacts | switching action | connection method | key removable in | part no. | circuit drawing | technical drawing | mounting dimensions | component layout | |
|--|----------------------|----------------|-------------|------------------|--------------------|------------------|--------------------|-----------------|-------------------|---------------------|------------------|-------|
| keylock switch 2 positions for flush mounting 51 - 79 mm | IP 40 | 51 mm | 1 NC + 1 NO | M | P | A | 781-.401-0P | 21 | 46 | 14 | 1 | 0,022 |
| | | | | MA | P | A | 771-.401-0P | 20 | 46 | 14 | 1 | 0,022 |
| | | | | | | A+C | 761-.401-0P | 20 | 46 | 14 | 1 | 0,022 |
| | | | 2 NC + 2 NO | M | P | A | 782-.401-0P | 23 | 46 | 14 | 1 | 0,023 |
| | | | | MA | P | A | 772-.401-0P | 22 | 46 | 14 | 1 | 0,023 |
| | | | | | | A+C | 762-.401-0P | 22 | 46 | 14 | 1 | 0,023 |
| | | 54 mm | 1 NC + 1 NO | M | - | A | 781-.401-00 | 21 | 47 | 14 | | 0,022 |
| | | | | MA | - | A | 771-.401-00 | 20 | 47 | 14 | | 0,022 |
| | | | | | | A+C | 761-.401-00 | 20 | 47 | 14 | | 0,022 |
| | | | 2 NC + 2 NO | M | - | A | 782-.401-00 | 23 | 47 | 14 | | 0,023 |
| | | | | MA | - | A | 772-.401-00 | 22 | 47 | 14 | | 0,023 |
| | | | | | | A+C | 762-.401-00 | 22 | 47 | 14 | | 0,023 |
| | | 61 mm | 1 NC + 1 NO | M | P | A | 931-.401-0P | 25 | 48 | 14 | 1 | 0,024 |
| | | | | MA | P | A | 921-.401-0P | 24 | 48 | 14 | 1 | 0,024 |
| | | | | | | A+C | 911-.401-0P | 24 | 48 | 14 | 1 | 0,024 |
| | | | 2 NC + 2 NO | M | P | A | 932-.401-0P | 23 | 48 | 14 | 1 | 0,025 |
| | | | | MA | P | A | 922-.401-0P | 22 | 48 | 14 | 1 | 0,025 |
| | | | | | | A+C | 912-.401-0P | 22 | 48 | 14 | 1 | 0,025 |
| | | | 3 NC + 3 NO | M | P | A | 933-.401-0P | 27 | 48 | 14 | 1 | 0,026 |
| | | | | MA | P | A | 923-.401-0P | 26 | 48 | 14 | 1 | 0,026 |
| | | | | | | A+C | 913-.401-0P | 26 | 48 | 14 | 1 | 0,026 |
| | | | 4 NC + 4 NO | M | P | A | 934-.401-0P | 29 | 48 | 14 | 1 | 0,029 |
| | | | | MA | P | A | 924-.401-0P | 28 | 48 | 14 | 1 | 0,029 |
| | | | | | | A+C | 914-.401-0P | 28 | 48 | 14 | 1 | 0,029 |
| 5 NC + 5 NO | M | | P | A | 935-.401-0P | 31 | 48 | 14 | 1 | 0,032 | | |
| | MA | | P | A | 925-.401-0P | 30 | 48 | 14 | 1 | 0,032 | | |
| | | | | A+C | 915-.401-0P | 30 | 48 | 14 | 1 | 0,032 | | |

Continued on next page

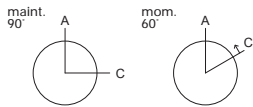

| keylock switch 2 positions for flush mounting 51 - 79 mm | degree of protection | mounting depth | contacts | switching action | connection method | key removable in | part no. | circuit drawing | technical drawing | mounting dimensions | component layout | ② | | |
|---|----------------------|----------------|-------------|------------------|-------------------|--------------------|--------------------|--------------------|--------------------|---------------------|------------------|-------|-------|-------|
| | | | | | | | | | | | | | | |
| keylock switch 2 positions for flush mounting 51 - 79 mm | IP 40 | 64 mm | 1 NC + 1 NO | M | - | A | 931-.401-00 | 25 | 49 | 14 | | 0,024 | | |
| | | | | MA | - | A | 921-.401-00 | 24 | 49 | 14 | | 0,024 | | |
| | | | | | - | A+C | 911-.401-00 | 24 | 49 | 14 | | 0,024 | | |
| | | | 2 NC + 2 NO | M | - | A | 932-.401-00 | 23 | 49 | 14 | | 0,025 | | |
| | | | | MA | - | A | 922-.401-00 | 22 | 49 | 14 | | 0,025 | | |
| | | | | | - | A+C | 912-.401-00 | 22 | 49 | 14 | | 0,025 | | |
| | | | 3 NC + 3 NO | M | - | A | 933-.401-00 | 27 | 49 | 14 | | 0,027 | | |
| | | | | MA | - | A | 923-.401-00 | 26 | 49 | 14 | | 0,027 | | |
| | | | | | - | A+C | 913-.401-00 | 26 | 49 | 14 | | 0,027 | | |
| | | | 4 NC + 4 NO | M | - | A | 934-.401-00 | 29 | 49 | 14 | | 0,030 | | |
| | | | | MA | - | A | 924-.401-00 | 28 | 49 | 14 | | 0,030 | | |
| | | | | | - | A+C | 914-.401-00 | 28 | 49 | 14 | | 0,030 | | |
| | | | 5 NC + 5 NO | M | - | A | 935-.401-00 | 31 | 49 | 14 | | 0,033 | | |
| | | | | MA | - | A | 925-.401-00 | 30 | 49 | 14 | | 0,033 | | |
| | | | | | - | A+C | 915-.401-00 | 30 | 49 | 14 | | 0,033 | | |
| | | | IP 40 | 76 mm | 1 NC + 1 NO | M | P | A | 831-.401-0P | 25 | 50 | 14 | 1 | 0,026 |
| | | | | | | MA | P | A | 821-.401-0P | 24 | 50 | 14 | 1 | 0,026 |
| | | | | | | | P | A+C | 811-.401-0P | 24 | 50 | 14 | 1 | 0,026 |
| | 2 NC + 2 NO | M | | | P | A | 832-.401-0P | 23 | 50 | 14 | 1 | 0,027 | | |
| | | MA | | | P | A | 822-.401-0P | 22 | 50 | 14 | 1 | 0,027 | | |
| | | | | | P | A+C | 812-.401-0P | 22 | 50 | 14 | 1 | 0,027 | | |
| | 3 NC + 3 NO | M | | | P | A | 833-.401-0P | 27 | 50 | 14 | 1 | 0,028 | | |
| | | MA | | | P | A | 823-.401-0P | 26 | 50 | 14 | 1 | 0,028 | | |
| | | | | | P | A+C | 813-.401-0P | 26 | 50 | 14 | 1 | 0,028 | | |
| | 4 NC + 4 NO | M | | | P | A | 834-.401-0P | 29 | 50 | 14 | 1 | 0,031 | | |
| | | MA | | | P | A | 824-.401-0P | 28 | 50 | 14 | 1 | 0,031 | | |
| | | | | | P | A+C | 814-.401-0P | 28 | 50 | 14 | 1 | 0,031 | | |
| | 5 NC + 5 NO | M | | | P | A | 835-.401-0P | 31 | 50 | 14 | 1 | 0,034 | | |
| | | MA | | | P | A | 825-.401-0P | 30 | 50 | 14 | 1 | 0,034 | | |
| | | | | | P | A+C | 815-.401-0P | 30 | 50 | 14 | 1 | 0,034 | | |
| | IP 40 | 79 mm | | | 1 NC + 1 NO | M | - | A | 831-.401-00 | 25 | 51 | 14 | | 0,026 |
| | | | | | | MA | - | A | 821-.401-00 | 24 | 51 | 14 | | 0,026 |
| | | | | | | | - | A+C | 811-.401-00 | 24 | 51 | 14 | | 0,026 |
| | | | 2 NC + 2 NO | M | - | A | 832-.401-00 | 23 | 51 | 14 | | 0,027 | | |
| | | | | MA | - | A | 822-.401-00 | 22 | 51 | 14 | | 0,027 | | |
| | | | | | - | A+C | 812-.401-00 | 22 | 51 | 14 | | 0,027 | | |
| 3 NC + 3 NO | | | M | - | A | 833-.401-00 | 27 | 51 | 14 | | 0,029 | | | |
| | | | MA | - | A | 823-.401-00 | 26 | 51 | 14 | | 0,029 | | | |
| | | | | - | A+C | 813-.401-00 | 26 | 51 | 14 | | 0,029 | | | |
| 4 NC + 4 NO | | | M | - | A | 834-.401-00 | 29 | 51 | 14 | | 0,032 | | | |
| | | | MA | - | A | 824-.401-00 | 28 | 51 | 14 | | 0,032 | | | |
| | | | | - | A+C | 814-.401-00 | 28 | 51 | 14 | | 0,032 | | | |
| 5 NC + 5 NO | | | M | - | A | 835-.401-00 | 31 | 51 | 14 | | 0,035 | | | |
| | | | MA | - | A | 825-.401-00 | 30 | 51 | 14 | | 0,035 | | | |
| | | | | - | A+C | 815-.401-00 | 30 | 51 | 14 | | 0,035 | | | |
| IP 65 | | | 51 mm | 1 NC + 1 NO | M | P | A | 781-.401-WP | 21 | 46 | 14 | 1 | 0,022 | |
| | | | | | MA | P | A | 771-.401-WP | 20 | 46 | 14 | 1 | 0,022 | |
| | | | | | | P | A+C | 761-.401-WP | 20 | 46 | 14 | 1 | 0,022 | |
| | 2 NC + 2 NO | M | | P | A | 782-.401-WP | 23 | 46 | 14 | 1 | 0,023 | | | |
| | | MA | | P | A | 772-.401-WP | 22 | 46 | 14 | 1 | 0,023 | | | |
| | | | | P | A+C | 762-.401-WP | 22 | 46 | 14 | 1 | 0,023 | | | |

Continued on next page

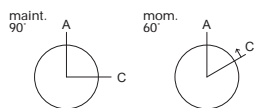

| keylock switch 2 positions for flush mounting 51 - 79 mm | degree of protection | mounting depth | contacts | switching action | connection method | key removable in | part no. | circuit drawing | technical drawing | mounting dimensions | component layout | kg | |
|--|----------------------|----------------|-------------|------------------|--------------------|--------------------|--------------------|--------------------|-------------------|---------------------|------------------|-------|-------|
| | | | | | | | | | | | | | |
| keylock switch 2 positions for flush mounting 51 - 79 mm | IP 65 | 54 mm | 1 NC + 1 NO | M | - | A | 781-.401-W0 | 21 | 47 | 14 | | 0,022 | |
| | | | | MA | - | A | 771-.401-W0 | 20 | 47 | 14 | | 0,022 | |
| | | | | | | A+C | 761-.401-W0 | 20 | 47 | 14 | | 0,022 | |
| | | | 2 NC + 2 NO | M | - | A | 782-.401-W0 | 23 | 47 | 14 | | 0,023 | |
| | | | | MA | - | A | 772-.401-W0 | 22 | 47 | 14 | | 0,023 | |
| | | | | | | A+C | 762-.401-W0 | 22 | 47 | 14 | | 0,023 | |
| | | 61 mm | 1 NC + 1 NO | M | P | A | 931-.401-WP | 25 | 48 | 14 | 1 | 0,024 | |
| | | | | MA | P | A | 921-.401-WP | 24 | 48 | 14 | 1 | 0,024 | |
| | | | | | | A+C | 911-.401-WP | 24 | 48 | 14 | 1 | 0,024 | |
| | | | 2 NC + 2 NO | M | P | A | 932-.401-WP | 23 | 48 | 14 | 1 | 0,025 | |
| | | | | MA | P | A | 922-.401-WP | 22 | 48 | 14 | 1 | 0,025 | |
| | | | | | | A+C | 912-.401-WP | 22 | 48 | 14 | 1 | 0,025 | |
| | | | 3 NC + 3 NO | M | P | A | 933-.401-WP | 27 | 48 | 14 | 1 | 0,026 | |
| | | | | MA | P | A | 923-.401-WP | 26 | 48 | 14 | 1 | 0,026 | |
| | | | | | | A+C | 913-.401-WP | 26 | 48 | 14 | 1 | 0,026 | |
| | | | 4 NC + 4 NO | M | P | A | 934-.401-WP | 29 | 48 | 14 | 1 | 0,029 | |
| | | | | MA | P | A | 924-.401-WP | 28 | 48 | 14 | 1 | 0,029 | |
| | | | | | | A+C | 914-.401-WP | 28 | 48 | 14 | 1 | 0,029 | |
| | | | 5 NC + 5 NO | M | P | A | 935-.401-WP | 31 | 48 | 14 | 1 | 0,032 | |
| | | | | MA | P | A | 925-.401-WP | 30 | 48 | 14 | 1 | 0,032 | |
| | | | | | | A+C | 915-.401-WP | 30 | 48 | 14 | 1 | 0,032 | |
| | | | 64 mm | 1 NC + 1 NO | M | - | A | 931-.401-W0 | 25 | 49 | 14 | | 0,024 |
| | | | | | MA | - | A | 921-.401-W0 | 24 | 49 | 14 | | 0,024 |
| | | | | | | | A+C | 911-.401-W0 | 24 | 49 | 14 | | 0,024 |
| | | 2 NC + 2 NO | | M | - | A | 932-.401-W0 | 23 | 49 | 14 | | 0,025 | |
| | | | | MA | - | A | 922-.401-W0 | 22 | 49 | 14 | | 0,025 | |
| | | | | | | A+C | 912-.401-W0 | 22 | 49 | 14 | | 0,025 | |
| | | 3 NC + 3 NO | | M | - | A | 933-.401-W0 | 27 | 49 | 14 | | 0,027 | |
| | | | | MA | - | A | 923-.401-W0 | 26 | 49 | 14 | | 0,027 | |
| | | | | | | A+C | 913-.401-W0 | 26 | 49 | 14 | | 0,027 | |
| | | 4 NC + 4 NO | | M | - | A | 934-.401-W0 | 29 | 49 | 14 | | 0,030 | |
| | | | | MA | - | A | 924-.401-W0 | 28 | 49 | 14 | | 0,030 | |
| | | | | | | A+C | 914-.401-W0 | 28 | 49 | 14 | | 0,030 | |
| | | 5 NC + 5 NO | | M | - | A | 935-.401-W0 | 31 | 49 | 14 | | 0,033 | |
| | | | | MA | - | A | 925-.401-W0 | 30 | 49 | 14 | | 0,033 | |
| | | | | | | A+C | 915-.401-W0 | 30 | 49 | 14 | | 0,033 | |
| 76 mm | 1 NC + 1 NO | M | | P | A | 831-.401-WP | 25 | 50 | 14 | 1 | 0,026 | | |
| | | MA | | P | A | 821-.401-WP | 24 | 50 | 14 | 1 | 0,026 | | |
| | | | | | A+C | 811-.401-WP | 24 | 50 | 14 | 1 | 0,026 | | |
| | 2 NC + 2 NO | M | P | A | 832-.401-WP | 23 | 50 | 14 | 1 | 0,027 | | | |
| | | MA | P | A | 822-.401-WP | 22 | 50 | 14 | 1 | 0,027 | | | |
| | | | | A+C | 812-.401-WP | 22 | 50 | 14 | 1 | 0,027 | | | |
| | 3 NC + 3 NO | M | P | A | 833-.401-WP | 27 | 50 | 14 | 1 | 0,028 | | | |
| | | MA | P | A | 823-.401-WP | 26 | 50 | 14 | 1 | 0,028 | | | |
| | | | | A+C | 813-.401-WP | 26 | 50 | 14 | 1 | 0,028 | | | |
| | 4 NC + 4 NO | M | P | A | 834-.401-WP | 29 | 50 | 14 | 1 | 0,031 | | | |
| | | MA | P | A | 824-.401-WP | 28 | 50 | 14 | 1 | 0,031 | | | |
| | | | | A+C | 814-.401-WP | 28 | 50 | 14 | 1 | 0,031 | | | |
| | 5 NC + 5 NO | M | P | A | 835-.401-WP | 31 | 50 | 14 | 1 | 0,034 | | | |
| | | MA | P | A | 825-.401-WP | 30 | 50 | 14 | 1 | 0,034 | | | |
| | | | | A+C | 815-.401-WP | 30 | 50 | 14 | 1 | 0,034 | | | |

Continued on next page

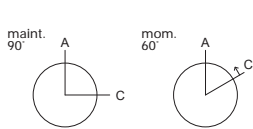

| | degree of protection | mounting depth | contacts | switching action | connection method | key removable in | part no. | circuit drawing | technical drawing | mounting dimensions | component layout | |
|--|----------------------|----------------|-------------|------------------|-------------------|------------------|--------------------|-----------------|-------------------|---------------------|------------------|-------|
| keylock switch 2 positions for flush mounting 51 - 79 mm | IP 65 | 79 mm | 1 NC + 1 NO | M | - | A | 831-.401-W0 | 25 | 51 | 14 | | 0,026 |
| | | | | MA | - | A | 821-.401-W0 | 24 | 51 | 14 | | 0,026 |
| | | | | | - | A+C | 811-.401-W0 | 24 | 51 | 14 | | 0,026 |
| | | | 2 NC + 2 NO | M | - | A | 832-.401-W0 | 23 | 51 | 14 | | 0,027 |
| | | | | MA | - | A | 822-.401-W0 | 22 | 51 | 14 | | 0,027 |
| | | | | | - | A+C | 812-.401-W0 | 22 | 51 | 14 | | 0,027 |
| | | | 3 NC + 3 NO | M | - | A | 833-.401-W0 | 27 | 51 | 14 | | 0,029 |
| | | | | MA | - | A | 823-.401-W0 | 26 | 51 | 14 | | 0,029 |
| | | | | | - | A+C | 813-.401-W0 | 26 | 51 | 14 | | 0,029 |
| | | | 4 NC + 4 NO | M | - | A | 834-.401-W0 | 29 | 51 | 14 | | 0,032 |
| | | | | MA | - | A | 824-.401-W0 | 28 | 51 | 14 | | 0,032 |
| | | | | | - | A+C | 814-.401-W0 | 28 | 51 | 14 | | 0,032 |
| | | | 5 NC + 5 NO | M | - | A | 835-.401-W0 | 31 | 51 | 14 | | 0,035 |
| | | | | MA | - | A | 825-.401-W0 | 30 | 51 | 14 | | 0,035 |
| | | | | | - | A+C | 815-.401-W0 | 30 | 51 | 14 | | 0,035 |

contacts : normally closed = NC, normally open = NO

switching action : maintained action = MA, momentary action = M

connection method : PCB terminal = P, soldering-/plug-in terminal = -

other key removable combination on request

hint:

- we recommend to use location strip no. 260-0020-00 for anti-twisting of the front bezel.

- at momentary position the overturning force is max. 60 Ncm.

circuit drawings from page 657, technical drawings from page 642, mounting dimensions from page 652, component layouts from page 657

keylock switch with 3 positions for flush mounting 51 - 54 mm



🛒 front cap for keylock-/selector switch 3 positions 626

🛒 front bezel-set for flush mounting page 628

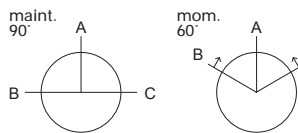

| | degree of protection | mounting depth | contacts | switching action | connection method | key removable in | part no. | circuit drawing | technical drawing | mounting dimensions | component layout | |
|--|----------------------|----------------|-------------|------------------|-------------------|--------------------|--------------------|-----------------|-------------------|---------------------|------------------|-------|
| keylock switch with 3 positions for flush mounting 51 - 54 mm | IP 40 | 51 mm | 2 NC + 2 NO | 0 - MA - MA | P | B+A+C | 722-.401-0P | 32 | 46 | 14 | 1 | 0,023 |
| | | | | M - 0 - M | P | A | 732-.401-0P | 33 | 46 | 14 | 1 | 0,023 |
| | | | | M - 0 - MA | P | A+C | 752-.401-0P | 35 | 46 | 14 | 1 | 0,023 |
| | | | | MA - 0 - M | P | B+A | 742-.401-0P | 34 | 46 | 14 | 1 | 0,023 |
| | | | | MA - 0 - MA | P | B+A+C | 712-.401-0P | 32 | 46 | 14 | 1 | 0,023 |
| | | 54 mm | 2 NC + 2 NO | 0 - MA - MA | - | B+A+C | 722-.401-00 | 32 | 47 | 14 | | 0,023 |
| | | | | M - 0 - M | - | A | 732-.401-00 | 33 | 47 | 14 | | 0,023 |
| | | | | M - 0 - MA | - | A+C | 752-.401-00 | 35 | 47 | 14 | | 0,023 |
| | IP 65 | 51 mm | 2 NC + 2 NO | 0 - MA - MA | P | B+A+C | 722-.401-WP | 32 | 46 | 14 | 1 | 0,023 |
| | | | | M - 0 - M | P | A | 732-.401-WP | 33 | 46 | 14 | 1 | 0,023 |
| | | | | M - 0 - MA | P | A+C | 752-.401-WP | 35 | 46 | 14 | 1 | 0,023 |
| | | | | MA - 0 - M | P | B+A | 742-.401-WP | 34 | 46 | 14 | 1 | 0,023 |
| | | | | MA - 0 - MA | P | B+A+C | 712-.401-WP | 32 | 46 | 14 | 1 | 0,023 |
| | | 54 mm | 2 NC + 2 NO | 0 - MA - MA | - | B+A+C | 722-.401-W0 | 32 | 47 | 14 | | 0,023 |
| | | | | M - 0 - M | - | A | 732-.401-W0 | 33 | 47 | 14 | | 0,023 |
| | | | | M - 0 - MA | - | A+C | 752-.401-W0 | 35 | 47 | 14 | | 0,023 |
| | | | MA - 0 - M | - | B+A | 742-.401-W0 | 34 | 47 | 14 | | 0,023 | |
| | | | MA - 0 - MA | - | B+A+C | 712-.401-W0 | 32 | 47 | 14 | | 0,023 | |

contacts : normally closed = NC, normally open = NO

switching action : maintained action = MA, momentary action = M

connection method : PCB terminal = P, soldering-/plug-in terminal = -

other key removable combination on request

hint:

- we recommend to use location strip no. 260-0020-00 for anti-twisting of the front bezel.

- at momentary position the overturning force is max. 60 Ncm.

circuit drawings from page 657, technical drawings from page 642, mounting dimensions from page 652, component layouts from page 657

selector switch 2 positions for flush mounting 51 - 79 mm



🛒 front cap for keylock-/selector switch 2 positions page 625

🛒 lever page 627

🛒 front bezel-set for flush mounting page 628

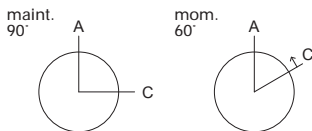

| selector switch 2 positions for flush mounting 51 - 79 mm | degree of protection | mounting depth | contacts | switching action | connection method | part no. | circuit drawing | technical drawing | mounting dimensions | component layout | 📄 |
|--|----------------------|----------------|-------------|------------------|-------------------|--------------------|-----------------|-------------------|---------------------|------------------|-------|
| | | | | | | | | | | | |
| selector switch 2 positions for flush mounting 51 - 79 mm | IP 40 | 51 mm | 1 NC + 1 NO | M | P | 781-.700-0P | 37 | 52 | 15 | 1 | 0,011 |
| | | | | MA | P | 761-.700-0P | 36 | 52 | 15 | 1 | 0,011 |
| | | | 2 NC + 2 NO | M | P | 782-.700-0P | 39 | 52 | 15 | 1 | 0,012 |
| | | | | MA | P | 762-.700-0P | 38 | 52 | 15 | 1 | 0,012 |
| | | 54 mm | 1 NC + 1 NO | M | - | 781-.700-00 | 37 | 53 | 15 | | 0,011 |
| | | | | MA | - | 761-.700-00 | 36 | 53 | 15 | | 0,011 |
| | | | 2 NC + 2 NO | M | - | 782-.700-00 | 39 | 53 | 15 | | 0,012 |
| | | | | MA | - | 762-.700-00 | 38 | 53 | 15 | | 0,012 |
| | | 61 mm | 1 NC + 1 NO | M | P | 931-.700-0P | 41 | 54 | 15 | 1 | 0,013 |
| | | | | MA | P | 911-.700-0P | 40 | 54 | 15 | 1 | 0,013 |
| | | | 2 NC + 2 NO | M | P | 932-.700-0P | 39 | 54 | 15 | 1 | 0,014 |
| | | | | MA | P | 912-.700-0P | 38 | 54 | 15 | 1 | 0,014 |
| | | | 3 NC + 3 NO | M | P | 933-.700-0P | 43 | 54 | 15 | 1 | 0,015 |
| | | | | MA | P | 913-.700-0P | 42 | 54 | 15 | 1 | 0,015 |
| | | | 4 NC + 4 NO | M | P | 934-.700-0P | 45 | 54 | 15 | 1 | 0,018 |
| | | | | MA | P | 914-.700-0P | 44 | 54 | 15 | 1 | 0,018 |
| | | | 5 NC + 5 NO | M | P | 935-.700-0P | 47 | 54 | 15 | 1 | 0,022 |
| | | | | MA | P | 915-.700-0P | 46 | 54 | 15 | 1 | 0,022 |
| | | 64 mm | 1 NC + 1 NO | M | - | 931-.700-00 | 41 | 55 | 15 | | 0,013 |
| | | | | MA | - | 911-.700-00 | 40 | 55 | 15 | | 0,013 |
| | | | 2 NC + 2 NO | M | - | 932-.700-00 | 39 | 55 | 15 | | 0,014 |
| | | | | MA | - | 912-.700-00 | 38 | 55 | 15 | | 0,014 |
| | | | 3 NC + 3 NO | M | - | 933-.700-00 | 43 | 55 | 15 | | 0,015 |
| | | | | MA | - | 913-.700-00 | 42 | 55 | 15 | | 0,015 |
| | | | 4 NC + 4 NO | M | - | 934-.700-00 | 45 | 55 | 15 | | 0,019 |
| | | | | MA | - | 914-.700-00 | 44 | 55 | 15 | | 0,019 |
| | | | 5 NC + 5 NO | M | - | 935-.700-00 | 47 | 55 | 15 | | 0,023 |
| | | | | MA | - | 915-.700-00 | 46 | 55 | 15 | | 0,023 |

Continued on next page

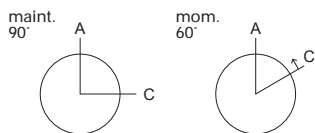

selector switch 2 positions
for flush mounting 51 - 79 mm

| degree of protection | mounting depth | contacts | switching action | connection method | part no. | circuit drawing | technical drawing | mounting dimensions | component layout |  | |
|----------------------|----------------|-------------|------------------|-------------------|--------------------|--------------------|-------------------|---------------------|------------------|---|-------|
| IP 65 | 76 mm | 1 NC + 1 NO | M | P | 831-.700-0P | 41 | 56 | 15 | 1 | 0,015 | |
| | | | MA | P | 811-.700-0P | 40 | 56 | 15 | 1 | 0,015 | |
| | | 2 NC + 2 NO | M | P | 832-.700-0P | 39 | 56 | 15 | 1 | 0,016 | |
| | | | MA | P | 812-.700-0P | 38 | 56 | 15 | 1 | 0,016 | |
| | | 3 NC + 3 NO | M | P | 833-.700-0P | 43 | 56 | 15 | 1 | 0,017 | |
| | | | MA | P | 813-.700-0P | 42 | 56 | 15 | 1 | 0,017 | |
| | | 4 NC + 4 NO | M | P | 834-.700-0P | 45 | 56 | 15 | 1 | 0,020 | |
| | | | MA | P | 814-.700-0P | 44 | 56 | 15 | 1 | 0,020 | |
| | | 5 NC + 5 NO | M | P | 835-.700-0P | 47 | 56 | 15 | 1 | 0,024 | |
| | | | MA | P | 815-.700-0P | 46 | 56 | 15 | 1 | 0,024 | |
| | | 79 mm | 1 NC + 1 NO | M | - | 831-.700-00 | 41 | 57 | 15 | | 0,015 |
| | | | | MA | - | 811-.700-00 | 40 | 57 | 15 | | 0,015 |
| | 2 NC + 2 NO | | M | - | 832-.700-00 | 39 | 57 | 15 | | 0,016 | |
| | | | MA | - | 812-.700-00 | 38 | 57 | 15 | | 0,016 | |
| | 3 NC + 3 NO | | M | - | 833-.700-00 | 43 | 57 | 15 | | 0,017 | |
| | | | MA | - | 813-.700-00 | 42 | 57 | 15 | | 0,017 | |
| | 4 NC + 4 NO | | M | - | 834-.700-00 | 45 | 57 | 15 | | 0,021 | |
| | | | MA | - | 814-.700-00 | 44 | 57 | 15 | | 0,021 | |
| | 5 NC + 5 NO | | M | - | 835-.700-00 | 47 | 57 | 15 | | 0,025 | |
| | | | MA | - | 815-.700-00 | 46 | 57 | 15 | | 0,025 | |
| | 51 mm | | 1 NC + 1 NO | M | P | 781-.700-WP | 37 | 52 | 15 | 1 | 0,011 |
| | | | | MA | P | 761-.700-WP | 36 | 52 | 15 | 1 | 0,011 |
| | | 2 NC + 2 NO | M | P | 782-.700-WP | 39 | 52 | 15 | 1 | 0,012 | |
| | | | MA | P | 762-.700-WP | 38 | 52 | 15 | 1 | 0,012 | |
| | 54 mm | 1 NC + 1 NO | M | - | 781-.700-W0 | 37 | 53 | 15 | | 0,011 | |
| | | | MA | - | 761-.700-W0 | 36 | 53 | 15 | | 0,011 | |
| | | 2 NC + 2 NO | M | - | 782-.700-W0 | 39 | 53 | 15 | | 0,012 | |
| | | | MA | - | 762-.700-W0 | 38 | 53 | 15 | | 0,012 | |
| | 61 mm | 1 NC + 1 NO | M | P | 931-.700-WP | 41 | 54 | 15 | 1 | 0,013 | |
| | | | MA | P | 911-.700-WP | 40 | 54 | 15 | 1 | 0,013 | |
| | | 2 NC + 2 NO | M | P | 932-.700-WP | 39 | 54 | 15 | 1 | 0,014 | |
| | | | MA | P | 912-.700-WP | 38 | 54 | 15 | 1 | 0,014 | |
| | | 3 NC + 3 NO | M | P | 933-.700-WP | 43 | 54 | 15 | 1 | 0,015 | |
| | | | MA | P | 913-.700-WP | 42 | 54 | 15 | 1 | 0,015 | |
| | | 4 NC + 4 NO | M | P | 934-.700-WP | 45 | 54 | 15 | 1 | 0,018 | |
| | | | MA | P | 914-.700-WP | 44 | 54 | 15 | 1 | 0,018 | |
| | | 5 NC + 5 NO | M | P | 935-.700-WP | 47 | 54 | 15 | 1 | 0,022 | |
| | | | MA | P | 915-.700-WP | 46 | 54 | 15 | 1 | 0,022 | |
| | | 64 mm | 1 NC + 1 NO | M | - | 931-.700-W0 | 41 | 55 | 15 | | 0,013 |
| | | | | MA | - | 911-.700-W0 | 40 | 55 | 15 | | 0,013 |
| | 2 NC + 2 NO | | M | - | 932-.700-W0 | 39 | 55 | 15 | | 0,014 | |
| | | | MA | - | 912-.700-W0 | 38 | 55 | 15 | | 0,014 | |
| | 3 NC + 3 NO | | M | - | 933-.700-W0 | 43 | 55 | 15 | | 0,015 | |
| | | | MA | - | 913-.700-W0 | 42 | 55 | 15 | | 0,015 | |
| | 4 NC + 4 NO | | M | - | 934-.700-W0 | 45 | 55 | 15 | | 0,019 | |
| | | | MA | - | 914-.700-W0 | 44 | 55 | 15 | | 0,019 | |
| | 5 NC + 5 NO | | M | - | 935-.700-W0 | 47 | 55 | 15 | | 0,023 | |
| | | | MA | - | 915-.700-W0 | 46 | 55 | 15 | | 0,023 | |

Continued on next page

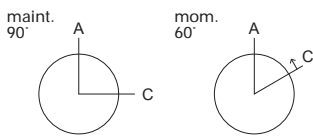

| | degree of protection | mounting depth | contacts | switching action | connection method | part no. | circuit drawing | technical drawing | mounting dimensions | component layout | |
|---|----------------------|----------------|-------------|------------------|-------------------|--------------------|-----------------|-------------------|---------------------|------------------|-------|
| selector switch 2 positions for flush mounting 51 - 79 mm | IP 65 | 76 mm | 1 NC + 1 NO | M | P | 831-.700-WP | 41 | 56 | 15 | 1 | 0,015 |
| | | | | MA | P | 811-.700-WP | 40 | 56 | 15 | 1 | 0,015 |
| | | | 2 NC + 2 NO | M | P | 832-.700-WP | 39 | 56 | 15 | 1 | 0,016 |
| | | | | MA | P | 812-.700-WP | 38 | 56 | 15 | 1 | 0,016 |
| | | | 3 NC + 3 NO | M | P | 833-.700-WP | 43 | 56 | 15 | 1 | 0,017 |
| | | | | MA | P | 813-.700-WP | 42 | 56 | 15 | 1 | 0,017 |
| | | | 4 NC + 4 NO | M | P | 834-.700-WP | 45 | 56 | 15 | 1 | 0,020 |
| | | | | MA | P | 814-.700-WP | 44 | 56 | 15 | 1 | 0,020 |
| | | | 5 NC + 5 NO | M | P | 835-.700-WP | 47 | 56 | 15 | 1 | 0,024 |
| | | | | MA | P | 815-.700-WP | 46 | 56 | 15 | 1 | 0,024 |
| | | 79 mm | 1 NC + 1 NO | M | - | 831-.700-WO | 41 | 57 | 15 | | 0,015 |
| | | | | MA | - | 811-.700-WO | 40 | 57 | 15 | | 0,015 |
| | | | 2 NC + 2 NO | M | - | 832-.700-WO | 39 | 57 | 15 | | 0,016 |
| | | | | MA | - | 812-.700-WO | 38 | 57 | 15 | | 0,016 |
| | | | 3 NC + 3 NO | M | - | 833-.700-WO | 43 | 57 | 15 | | 0,017 |
| | | | | MA | - | 813-.700-WO | 42 | 57 | 15 | | 0,017 |
| | | | 4 NC + 4 NO | M | - | 834-.700-WO | 45 | 57 | 15 | | 0,021 |
| | | | | MA | - | 814-.700-WO | 44 | 57 | 15 | | 0,021 |
| | | | 5 NC + 5 NO | M | - | 835-.700-WO | 47 | 57 | 15 | | 0,025 |
| | | | | MA | - | 815-.700-WO | 46 | 57 | 15 | | 0,025 |

contacts : normally closed = NC, normally open = NO

switching action : maintained action = MA, momentary action = M

connection method : PCB terminal = P, soldering-/plug-in terminal = -

hint:

- we recommend to use location strip no. 260-0020-00 for anti-twisting of the front bezel.

- at momentary position the overturning force is max. 60 Ncm.

circuit drawings from page 657, technical drawings from page 642, mounting dimensions from page 652, component layouts from page 657

selector switch 3 positions for flush mounting 51 - 54 mm



🛒 front cap for keylock-/selector switch 3 positions page 626

🛒 lever page 627

🛒 front bezel-set for flush mounting page 628

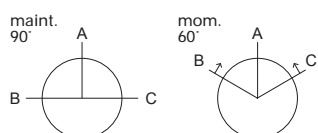

| | degree of protection | mounting depth | contacts | switching action | connection method | part no. | circuit drawing | technical drawing | mounting dimensions | component layout | |
|---|----------------------|--------------------|-------------|--------------------|--------------------|--------------------|-----------------|-------------------|---------------------|------------------|-------|
| selector switch 3 positions for flush mounting 51 - 54 mm | IP 40 | 51 mm | 2 NC + 2 NO | 0 - MA - MA | P | 722-.700-0P | 48 | 52 | 15 | 1 | 0,012 |
| | | | | M - 0 - M | P | 732-.700-0P | 49 | 52 | 15 | 1 | 0,012 |
| | | | | M - 0 - MA | P | 752-.700-0P | 51 | 52 | 15 | 1 | 0,012 |
| | | | | MA - 0 - M | P | 742-.700-0P | 50 | 52 | 15 | 1 | 0,012 |
| | | MA - 0 - MA | P | 712-.700-0P | 48 | 52 | 15 | 1 | 0,012 | | |
| | | 54 mm | 2 NC + 2 NO | 0 - MA - MA | - | 722-.700-00 | 48 | 53 | 15 | | 0,012 |
| | | | | M - 0 - M | - | 732-.700-00 | 49 | 53 | 15 | | 0,012 |
| | | | | M - 0 - MA | - | 752-.700-00 | 51 | 53 | 15 | | 0,012 |
| | MA - 0 - M | | | - | 742-.700-00 | 50 | 53 | 15 | | 0,012 | |
| | IP 65 | 51 mm | 2 NC + 2 NO | 0 - MA - MA | P | 722-.700-WP | 48 | 52 | 15 | 1 | 0,012 |
| | | | | M - 0 - M | P | 732-.700-WP | 49 | 52 | 15 | 1 | 0,012 |
| | | | | M - 0 - MA | P | 752-.700-WP | 51 | 52 | 15 | 1 | 0,012 |
| | | | | MA - 0 - M | P | 742-.700-WP | 50 | 52 | 15 | 1 | 0,012 |
| | | MA - 0 - MA | P | 712-.700-WP | 48 | 52 | 15 | 1 | 0,012 | | |
| | | 54 mm | 2 NC + 2 NO | 0 - MA - MA | - | 722-.700-W0 | 48 | 53 | 15 | | 0,012 |
| | | | | M - 0 - M | - | 732-.700-W0 | 49 | 53 | 15 | | 0,012 |
| M - 0 - MA | | | | - | 752-.700-W0 | 51 | 53 | 15 | | 0,012 | |
| MA - 0 - M | - | | | 742-.700-W0 | 50 | 53 | 15 | | 0,012 | | |
| MA - 0 - MA | - | 712-.700-W0 | 48 | 53 | 15 | | 0,012 | | | | |

contacts : normally closed = NC, normally open = NO

switching action: maintained action = MA, momentary action = M

connection method : PCB terminal = P, soldering-/plug-in terminal = -

hint:

- we recommend to use location strip no. 260-0020-00 for anti-twisting of the front bezel.

- at momentary position the overturning force is max. 60 Ncm.

circuit drawings from page 657, technical drawings from page 642, mounting dimensions from page 652, component layouts from page 657

buzzer for flush mounting 39 - 64 mm



- 🛒 buzzer element page 627
- 🛒 front bezel for buzzer 30 - 55 mm page 628
- 🛒 front bezel set for flush mounting for buzzer page 628

| | degree of protection | mounting depth | connection method | buzzer socket | part no. | circuit drawing | technical drawing | mounting dimensions | component layout | |
|---|----------------------|----------------|-------------------|---------------|--------------------|-----------------|-------------------|---------------------|------------------|-------|
| buzzer for flush mounting 39 - 64 mm | IP 40 | 39 mm | - | MG T 1 3/4 | 970-.000-K0 | 52 | 36 | 16 | | 0,004 |
| | | 61 mm | P | MG T 1 3/4 | 970-.000-0P | 52 | 38 | 16 | 1 | 0,007 |
| | | 64 mm | - | MG T 1 3/4 | 970-.000-00 | 52 | 39 | 16 | | 0,007 |

connection method : soldering-/plug-in terminal = -, PCB terminal = P

the buzzer 55 mm is as long as the corresponding illuminated pushbutton and fits to the PCB plug-in base and multi plug housing

circuit drawings from page 657, technical drawings from page 642, mounting dimensions from page 652, component layouts from page 657

at front

lens for 35 mm

for pushbuttons 35 mm

| | shape | lens/support | colour | ⌀ 18 x 24 mm Typ-Nr. | ⌀ 18 x 18 mm Typ-Nr. | 18 mm dia. Typ-Nr. |  |
|---|-------|-------------------------|--------|----------------------------|----------------------------|-----------------------|---|
| lens for 35 mm of plastic | flat | transparent/translucent | blue | 600-5150-00 | 600-3150-00 | 600-1150-00 | 0,001 |
| | | | yellow | 600-5170-00 | 600-3170-00 | 600-1170-00 | 0,001 |
| | | | green | 600-5140-00 | 600-3140-00 | 600-1140-00 | 0,001 |
| | | | orange | 600-5110-00 | 600-3110-00 | 600-1110-00 | 0,001 |
| | | | red | 600-5120-00 | 600-3120-00 | 600-1120-00 | 0,001 |
| | | | white | 600-5160-00 | 600-3160-00 | 600-1160-00 | 0,001 |
| of plastic (not recommended for film insert) | flat | transparent/transparent | blue | 600-5250-00 | 600-3250-00 | 600-1250-00 | 0,001 |
| | | | yellow | 600-5270-00 | 600-3270-00 | 600-1270-00 | 0,001 |
| | | | green | 600-5240-00 | 600-3240-00 | 600-1240-00 | 0,001 |
| | | | orange | 600-5210-00 | 600-3210-00 | 600-1210-00 | 0,001 |
| | | | red | 600-5220-00 | 600-3220-00 | 600-1220-00 | 0,001 |
| | | | white | 600-5260-00 | 600-3260-00 | 600-1260-00 | 0,001 |
| of plastic (not for film insert and illumination) | flat | opaque/translucent | grey | 600-5180-00 | 600-3180-00 | 600-1180-00 | 0,001 |
| | | | black | 600-5190-00 | 600-3190-00 | 600-1190-00 | 0,001 |



lens

| | degree of protection | front dimension pushbutton | shape | lens/support | colour | part no. |  |
|-----------------|----------------------|----------------------------|-------------------------|-------------------------|--------------------|--------------------|---|
| lens of plastic | IP 40 | 18 x 18 mm | flat | transparent/translucent | blue | 200-3150-00 | 0,001 |
| | | | | | yellow | 200-3170-00 | 0,001 |
| | | | | | green | 200-3140-00 | 0,001 |
| | | | | | orange | 200-3110-00 | 0,001 |
| | | | | | red | 200-3120-00 | 0,001 |
| | | white | 200-3160-00 | 0,001 | | | |
| | | 18 x 24 mm | flat | transparent/translucent | blue | 200-5150-00 | 0,001 |
| | | | | | yellow | 200-5170-00 | 0,001 |
| | | | | | green | 200-5140-00 | 0,001 |
| | | | | | orange | 200-5110-00 | 0,001 |
| | | | | | red | 200-5120-00 | 0,001 |
| | | white | 200-5160-00 | 0,001 | | | |
| | | 24 x 24 mm | flat | transparent/translucent | blue | 200-9150-00 | 0,001 |
| | | | | | yellow | 200-9170-00 | 0,001 |
| | | | | | green | 200-9140-00 | 0,001 |
| | | | | | orange | 200-9110-00 | 0,001 |
| | | | | | red | 200-9120-00 | 0,001 |
| | | white | 200-9160-00 | 0,001 | | | |
| | | 18 mm dia. | flat | transparent/translucent | blue | 200-1150-00 | 0,001 |
| | | | | | yellow | 200-1170-00 | 0,001 |
| | green | | | | 200-1140-00 | 0,001 | |
| | orange | | | | 200-1110-00 | 0,001 | |
| | red | | | | 200-1120-00 | 0,001 | |
| | white | 200-1160-00 | 0,001 | | | | |
| | 24 mm dia. | flat | transparent/translucent | blue | 200-7150-00 | 0,001 | |
| | | | | yellow | 200-7170-00 | 0,001 | |
| | | | | green | 200-7140-00 | 0,001 | |
| | | | | orange | 200-7110-00 | 0,001 | |
| | | | | red | 200-7120-00 | 0,001 | |
| | white | 200-7160-00 | 0,001 | | | | |
| | IP 65 | 24 x 24 mm | flat | transparent/translucent | blue | 200-9150-W0 | 0,002 |
| | | | | | yellow | 200-9170-W0 | 0,002 |
| | | | | | green | 200-9140-W0 | 0,002 |
| | | | | | orange | 200-9110-W0 | 0,002 |
| | | | | | red | 200-9120-W0 | 0,002 |
| | | | | | white | 200-9160-W0 | 0,002 |
| | | | | | 24 mm dia. | flat | transparent/translucent |
| | | yellow | 200-7170-W0 | 0,002 | | | |
| | | green | 200-7140-W0 | 0,002 | | | |
| | | orange | 200-7110-W0 | 0,002 | | | |
| red | | 200-7120-W0 | 0,002 | | | | |
| white | | 200-7160-W0 | 0,002 | | | | |



Continued on next page

| | | | | | | | |
|--|--------------------|-----------------------------|-----------------------------|-----------------------------|--------------------|--------------------|-------|
| lens of plastic (not recommended for film insert) | IP 40 | 18 x 18 mm | flat | transparent/ transparent | blue | 200-3250-00 | 0,001 |
| | | | | | yellow | 200-3270-00 | 0,001 |
| | | | | | green | 200-3240-00 | 0,001 |
| | | | | | orange | 200-3210-00 | 0,001 |
| | | | | | red | 200-3220-00 | 0,001 |
| | | white | 200-3260-00 | 0,001 | | | |
| | | 18 x 24 mm | flat | transparent/ transparent | blue | 200-5250-00 | 0,001 |
| | | | | | yellow | 200-5270-00 | 0,001 |
| | | | | | green | 200-5240-00 | 0,001 |
| | | | | | orange | 200-5210-00 | 0,001 |
| | | | | | red | 200-5220-00 | 0,001 |
| | | white | 200-5260-00 | 0,001 | | | |
| | | 24 x 24 mm | flat | transparent/ transparent | blue | 200-9250-00 | 0,001 |
| | | | | | yellow | 200-9270-00 | 0,001 |
| | | | | | green | 200-9240-00 | 0,001 |
| | orange | | | | 200-9210-00 | 0,001 | |
| | red | | | | 200-9220-00 | 0,001 | |
| | white | 200-9260-00 | 0,001 | | | | |
| | 18 mm dia. | flat | transparent/ transparent | blue | 200-1250-00 | 0,001 | |
| | | | | yellow | 200-1270-00 | 0,001 | |
| green | | | | 200-1240-00 | 0,001 | | |
| orange | | | | 200-1210-00 | 0,001 | | |
| red | | | | 200-1220-00 | 0,001 | | |
| white | 200-1260-00 | 0,001 | | | | | |
| 24 mm dia. | flat | transparent/ transparent | blue | 200-7250-00 | 0,001 | | |
| | | | yellow | 200-7270-00 | 0,001 | | |
| | | | green | 200-7240-00 | 0,001 | | |
| | | | orange | 200-7210-00 | 0,001 | | |
| | | | red | 200-7220-00 | 0,001 | | |
| white | 200-7260-00 | 0,001 | | | | | |
| IP 65 | 24 x 24 mm | flat | transparent/ transparent | blue | 200-9250-W0 | 0,002 | |
| | | | | yellow | 200-9270-W0 | 0,002 | |
| | | | | green | 200-9240-W0 | 0,002 | |
| | | | | orange | 200-9210-W0 | 0,002 | |
| | | | | red | 200-9220-W0 | 0,002 | |
| | white | 200-9260-W0 | 0,002 | | | | |
| | 24 mm dia. | flat | transparent/ transparent | blue | 200-7250-W0 | 0,002 | |
| | | | | yellow | 200-7270-W0 | 0,002 | |
| | | | | green | 200-7240-W0 | 0,002 | |
| | | | | orange | 200-7210-W0 | 0,002 | |
| red | | | | 200-7220-W0 | 0,002 | | |
| white | 200-7260-W0 | 0,002 | | | | | |
| of plastic (not for film insert and illumination) | IP 40 | 18 x 18 mm | flat | opaque/translucent | grey | 200-3180-00 | 0,001 |
| | | | | | black | 200-3190-00 | 0,001 |
| | | 18 x 24 mm | flat | opaque/translucent | grey | 200-5180-00 | 0,001 |
| | | | | | black | 200-5190-00 | 0,001 |
| | | 24 x 24 mm | flat | opaque/translucent | grey | 200-9180-00 | 0,001 |
| | | | | | black | 200-9190-00 | 0,001 |
| | | 18 mm dia. | flat | opaque/translucent | grey | 200-1180-00 | 0,001 |
| | | | | | black | 200-1190-00 | 0,001 |
| | | 24 mm dia. | flat | opaque/translucent | grey | 200-7180-00 | 0,001 |
| | | | | | black | 200-7190-00 | 0,001 |
| | IP 65 | 24 x 24 mm | flat | opaque/translucent | grey | 200-9180-W0 | 0,002 |
| | | | | | black | 200-9190-W0 | 0,002 |
| | | 24 mm dia. | flat | opaque/translucent | grey | 200-7180-W0 | 0,002 |
| | | | | | black | 200-7190-W0 | 0,002 |

mushroom-head cap

can only be used with front bezel 18 mm dia.

| | degree of protection | mushroom | colour | ☐ 18 x 24 mm Typ-Nr. | ☐ 24 x 24 mm Typ-Nr. | 24 mm dia. Typ-Nr. |  |
|--------------------------|----------------------|----------|--------|----------------------------|----------------------------|-----------------------|---|
| mushroom-head cap | IP 40 | opaque | yellow | 200-5370-00 | 200-9370-00 | 200-7370-00 | 0,005 |
| | | | green | 200-5340-00 | 200-9340-00 | 200-7340-00 | 0,005 |
| | | | red | 200-5320-00 | 200-9320-00 | 200-7320-00 | 0,005 |
| | | | black | 200-5390-00 | 200-9390-00 | 200-7390-00 | 0,005 |



front cap for keylock-/selector switch 2 positions

for IP 40/IP 65, will be delivered assembled

| | front dimension pushbutton | for switching action | marking | colour | part no. |  |
|--|-------------------------------|----------------------|-----------------|--------|--------------------|---|
| front cap for keylock-/selector switch 2 positions plastic, for types 761-... - 772-..., 911-... - 925-..., 811-... - 825-... | 18 x 18 mm | 0 - MA | 0 - I (90°) | grey | 200-3001-00 | 0,002 |
| | | | | black | 200-4001-00 | 0,002 |
| | 18 x 24 mm | 0 - MA | 0 - I (90°) | grey | 200-5001-00 | 0,002 |
| | | | | black | 200-6001-00 | 0,002 |
| | 24 x 24 mm | 0 - MA | 0 - I (90°) | grey | 200-9001-00 | 0,002 |
| | | | | black | 200-0001-00 | 0,002 |
| | 18 mm dia. | 0 - MA | 0 - I (90°) | grey | 200-1001-00 | 0,002 |
| | | | | black | 200-2001-00 | 0,002 |
| | 24 mm dia. | 0 - MA | 0 - I (90°) | grey | 200-7001-00 | 0,002 |
| | | | | black | 200-8001-00 | 0,002 |
| plastic, for types 781-... - 782-..., 931-... - 935-..., 831-... - 835-... | 18 x 18 mm | 0 - M | 0 - I (60°) | grey | 200-3001-01 | 0,002 |
| | | | | black | 200-4001-01 | 0,002 |
| | 18 x 24 mm | 0 - M | 0 - I (60°) | grey | 200-5001-01 | 0,002 |
| | | | | black | 200-6001-01 | 0,002 |
| | 24 x 24 mm | 0 - M | 0 - I (60°) | grey | 200-9001-01 | 0,002 |
| | | | | black | 200-0001-01 | 0,002 |
| | 18 mm dia. | 0 - M | 0 - I (60°) | grey | 200-1001-01 | 0,002 |
| | | | | black | 200-2001-01 | 0,002 |
| | 24 mm dia. | 0 - M | 0 - I (60°) | grey | 200-7001-01 | 0,002 |
| | | | | black | 200-8001-01 | 0,002 |
| of plastic, fits for all types | 18 x 18 mm | M- or MA action | without marking | grey | 200-3004-00 | 0,002 |
| | | | | black | 200-4004-00 | 0,002 |
| | 18 x 24 mm | M- or MA action | without marking | grey | 200-5004-00 | 0,002 |
| | | | | black | 200-6004-00 | 0,002 |
| | 24 x 24 mm | M- or MA action | without marking | grey | 200-9004-00 | 0,002 |
| | | | | black | 200-0004-00 | 0,002 |
| | 18 mm dia. | M- or MA action | without marking | grey | 200-1004-00 | 0,002 |
| | | | | black | 200-2004-00 | 0,002 |
| | 24 mm dia. | M- or MA action | without marking | grey | 200-7004-00 | 0,002 |
| | | | | black | 200-8004-00 | 0,002 |



front cap for keylock-/selector switch 3 positions

for IP 40/IP 65, will be delivered assembled

| | front dimension | for switching action | marking | colour | part no. |  |
|--|-----------------|----------------------|------------------------|--------|--------------------|---|
| front cap for keylock-/selector switch 3 positions plastic, for type 712-... | 18 x 18 mm | M - 0 - M | I (90°) - 0 - II (90°) | grey | 200-3002-00 | 0,002 |
| | | | | black | 200-4002-00 | 0,002 |
| | 18 x 24 mm | M - 0 - M | I (90°) - 0 - II (90°) | grey | 200-5002-00 | 0,002 |
| | | | | black | 200-6002-00 | 0,002 |
| | 24 x 24 mm | M - 0 - M | I (90°) - 0 - II (90°) | grey | 200-9002-00 | 0,002 |
| | | | | black | 200-0002-00 | 0,002 |
| | 18 mm dia. | M - 0 - M | I (90°) - 0 - II (90°) | grey | 200-1002-00 | 0,002 |
| | | | | black | 200-2002-00 | 0,002 |
| | 24 mm dia. | M - 0 - M | I (90°) - 0 - II (90°) | grey | 200-7002-00 | 0,002 |
| | | | | black | 200-8002-00 | 0,002 |
| plastic, for type 722-... | 18 x 18 mm | 0 - M - M | 0 (90°) - I - II (90°) | grey | 200-3003-01 | 0,002 |
| | | | | black | 200-4003-01 | 0,002 |
| | 18 x 24 mm | 0 - M - M | 0 (90°) - I - II (90°) | grey | 200-5003-01 | 0,002 |
| | | | | black | 200-6003-01 | 0,002 |
| | 24 x 24 mm | 0 - M - M | 0 (90°) - I - II (90°) | grey | 200-9003-01 | 0,002 |
| | | | | black | 200-0003-01 | 0,002 |
| | 18 mm dia. | 0 - M - M | 0 (90°) - I - II (90°) | grey | 200-1003-01 | 0,002 |
| | | | | black | 200-2003-01 | 0,002 |
| | 24 mm dia. | 0 - M - M | 0 (90°) - I - II (90°) | grey | 200-7003-01 | 0,002 |
| | | | | black | 200-8003-01 | 0,002 |
| plastic, for type 732-... | 18 x 18 mm | M - 0 - M | I (60°) - 0 - II (60°) | grey | 200-3002-02 | 0,002 |
| | | | | black | 200-4002-02 | 0,002 |
| | 18 x 24 mm | M - 0 - M | I (60°) - 0 - II (60°) | grey | 200-5002-02 | 0,002 |
| | | | | black | 200-6002-02 | 0,002 |
| | 24 x 24 mm | M - 0 - M | I (60°) - 0 - II (60°) | grey | 200-9002-02 | 0,002 |
| | | | | black | 200-0002-02 | 0,002 |
| | 18 mm dia. | M - 0 - M | I (60°) - 0 - II (60°) | grey | 200-1002-02 | 0,002 |
| | | | | black | 200-2002-02 | 0,002 |
| | 24 mm dia. | M - 0 - M | I (60°) - 0 - II (60°) | grey | 200-7002-02 | 0,002 |
| | | | | black | 200-8002-02 | 0,002 |
| plastic, for type 742-... | 18 x 18 mm | MA - 0 - M | I (90°) - 0 - II (60°) | grey | 200-3002-03 | 0,002 |
| | | | | black | 200-4002-03 | 0,002 |
| | 18 x 24 mm | MA - 0 - M | I (90°) - 0 - II (60°) | grey | 200-5002-03 | 0,002 |
| | | | | black | 200-6002-03 | 0,002 |
| | 24 x 24 mm | MA - 0 - M | I (90°) - 0 - II (60°) | grey | 200-9002-03 | 0,002 |
| | | | | black | 200-0002-03 | 0,002 |
| | 18 mm dia. | MA - 0 - M | I (90°) - 0 - II (60°) | grey | 200-1002-03 | 0,002 |
| | | | | black | 200-2002-03 | 0,002 |
| | 24 mm dia. | MA - 0 - M | I (90°) - 0 - II (60°) | grey | 200-7002-03 | 0,002 |
| | | | | black | 200-8002-03 | 0,002 |
| plastic, for type 752-... | 18 x 18 mm | M - 0 - MA | I (60°) - 0 - II (90°) | grey | 200-3002-04 | 0,002 |
| | | | | black | 200-4002-04 | 0,002 |
| | 18 x 24 mm | M - 0 - MA | I (60°) - 0 - II (90°) | grey | 200-5002-04 | 0,002 |
| | | | | black | 200-6002-04 | 0,002 |
| | 24 x 24 mm | M - 0 - MA | I (60°) - 0 - II (90°) | grey | 200-9002-04 | 0,002 |
| | | | | black | 200-0002-04 | 0,002 |
| | 18 mm dia. | M - 0 - MA | I (60°) - 0 - II (90°) | grey | 200-1002-04 | 0,002 |
| | | | | black | 200-2002-04 | 0,002 |
| | 24 mm dia. | M - 0 - MA | I (60°) - 0 - II (90°) | grey | 200-7002-04 | 0,002 |
| | | | | black | 200-8002-04 | 0,002 |



Continued on next page

| | | | | | | |
|--|------------|-----------------|-----------------|-------|--------------------|-------|
| front cap for keylock-/selector switch 3 positions of plastic, fits for all types | 18 x 18 mm | M- or MA action | without marking | grey | 200-3004-00 | 0,002 |
| | | | | black | 200-4004-00 | 0,002 |
| | 18 x 24 mm | M- or MA action | without marking | grey | 200-5004-00 | 0,002 |
| | | | | black | 200-6004-00 | 0,002 |
| | 24 x 24 mm | M- or MA action | without marking | grey | 200-9004-00 | 0,002 |
| | | | | black | 200-0004-00 | 0,002 |
| | 18 mm dia. | M- or MA action | without marking | grey | 200-1004-00 | 0,002 |
| | | | | black | 200-2004-00 | 0,002 |
| | 24 mm dia. | M- or MA action | without marking | grey | 200-7004-00 | 0,002 |
| | | | | black | 200-8004-00 | 0,002 |

lever

will be delivered assembled

| | construction | colour | part no. | |
|-------|--------------|-----------------|--------------------|-------|
| lever | short | black | 200-.704-00 | 0,001 |
| | | chromium-plated | 200-.604-00 | 0,001 |
| | long | black | 200-.904-00 | 0,001 |
| | | chromium-plated | 200-.804-00 | 0,001 |



buzzer element

| | voltage | colour | 18 x 24 mm Typ-Nr. | 24 x 24 mm Typ-Nr. | |
|----------------|------------|--------|--------------------|--------------------|-------|
| buzzer element | 6 V AC/DC | grey | 970-5006-00 | 970-9006-00 | 0,004 |
| | | black | 970-6006-00 | 970-0006-00 | 0,004 |
| | 12 V AC/DC | grey | 970-5012-00 | 970-9012-00 | 0,004 |
| | | black | 970-6012-00 | 970-0012-00 | 0,004 |
| | 24 V AC/DC | grey | 970-5024-00 | 970-9024-00 | 0,004 |
| | | black | 970-6024-00 | 970-0024-00 | 0,004 |



push-pull knob

| | knob | colour | part no. | |
|----------------|-------------|--------|--------------------|-------|
| push-pull knob | transparent | blue | 200-.255-00 | 0,003 |
| | | yellow | 200-.275-00 | 0,003 |
| | | green | 200-.245-00 | 0,003 |
| | | red | 200-.225-00 | 0,003 |
| | | white | 200-.265-00 | 0,003 |



front bezel for illuminated-/pushbutton 55 - 70 mm and indicator 30 - 70 mm

| | degree of protection | front dimension | material | colour | part no. | |
|---|----------------------|-----------------|----------|--------|--------------------|-------|
| front bezel for illuminated-/pushbutton 55 - 70 mm and indicator 30 - 70 mm | IP 40 | 18 x 18 mm | plastic | grey | 200-3000-00 | 0,002 |
| | | | | black | 200-4000-00 | 0,002 |
| | | 18 x 24 mm | plastic | grey | 200-5000-00 | 0,002 |
| | | | | black | 200-6000-00 | 0,002 |
| | | 24 x 24 mm | plastic | grey | 200-9000-00 | 0,002 |
| | | | | black | 200-0000-00 | 0,002 |
| | | 18 mm dia. | plastic | grey | 200-1000-00 | 0,002 |
| | | | | black | 200-2000-00 | 0,002 |
| | | 24 mm dia. | plastic | grey | 200-7000-00 | 0,002 |
| | | | | black | 200-8000-00 | 0,002 |
| | IP 65 | 24 x 24 mm | plastic | grey | 200-9000-W0 | 0,002 |
| | | | | black | 200-0000-W0 | 0,002 |
| | | 24 mm dia. | plastic | grey | 200-7000-W0 | 0,002 |
| | | | | black | 200-8000-W0 | 0,002 |





front bezel for mushroom-head pushbutton 55 - 70 mm

| | degree of protection | material | colour | 18 mm dia. Typ-Nr. |  |
|--|----------------------|----------|--------|-----------------------|---|
| front bezel for mushroom-head pushbutton 55 - 70 mm | IP 40 | plastic | grey | 200-1000-00 | 0,002 |
| | | | black | 200-2000-00 | 0,002 |





front bezel for buzzer 30 - 55 mm

| | degree of protection | material | colour |  18 x 24 mm Typ-Nr. |  24 x 24 mm Typ-Nr. |  |
|--|----------------------|----------|--------|--|--|---|
| front bezel for buzzer 30 - 55 mm | IP 40 | plastic | grey | 200-5000-00 | 200-9000-00 | 0,002 |
| | | | black | 200-6000-00 | 200-0000-00 | 0,002 |



front bezel-set for flush mounting

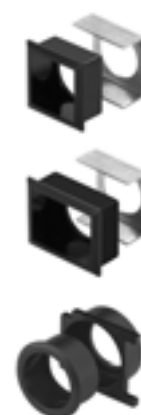

to us as IP 40: cut off (with knife) the anti-twisting at the front bezel/actuator

| | degree of protection | material | colour |  18 x 24 mm Typ-Nr. |  18 x 18 mm Typ-Nr. | 18 mm dia. Typ-Nr. |  |
|---|----------------------|----------|--------|--|--|-----------------------|---|
| front bezel-set for flush mounting 24 x 24 mm | IP 40/IP 65 | plastic | black | | 200-4400-V0 | | 0,007 |
| 24 x 30 mm | IP 40/IP 65 | plastic | black | 200-6400-V0 | | | 0,008 |
| 25 mm dia. | IP 40/IP 65 | plastic | black | | | 200-8400-V0 | 0,006 |



front bezel set for flush mounting for buzzer



to us as IP 40: cut off (with knife) the anti-twisting at the front bezel/actuator

| | degree of protection | material | colour |  18 x 24 mm Typ-Nr. |  |
|--|----------------------|----------|--------|--|---|
| front bezel set for flush mounting for buzzer 24 x 30 mm | IP 40 | plastic | black | 200-6400-V0 | 0,008 |



protective cover for 35 mm

for pushbuttons 35 mm

| | degree of protection |  18 x 24 mm Typ-Nr. |  18 x 18 mm Typ-Nr. | technical drawing |  |
|--|----------------------|--|--|-------------------|---|
| protective cover for 35 mm hinged, transparent, with means for sealing | IP 40 | 200-6008-00 | 200-4008-00 | 58 | 0,002 |
| | IP 65 | 200-6008-W0 | 200-4008-W0 | 58 | 0,002 |



technical drawings from page 642

protective cover for illuminated-/pushbutton 55 - 70 mm

| | degree of protection | 18 x 24 mm Typ-Nr. | 18 x 18 mm Typ-Nr. | 24 x 24 mm Typ-Nr. | technical drawing | |
|---|----------------------|-----------------------|-----------------------|-----------------------|-------------------|-------|
| protective cover for illuminated-/pushbutton 55 - 70 mm hinged, transparent, not with means for sealing, for use as IP 40: cut off (with knife) the anti-twisting at the front bezel/actuator | IP 40/IP 65 | | | 200-0008-W0 | 58 | 0,006 |
| hinged, transparent, with means for sealing | IP 40 | 200-6008-00 | 200-4008-00 | | 58 | 0,005 |



technical drawings from page 642

protective cover for flush mounting

to us as IP 40: cut off (with knife) the anti-twisting at the front bezel/actuator

| | degree of protection | use | material | colour | 18 x 24 mm Typ-Nr. | 18 x 18 mm Typ-Nr. | |
|---|----------------------|---|----------|--------|-----------------------|-----------------------|-------|
| protective cover for flush mounting 24x24 mm, hinged, transparent, with means for sealing | IP 40/IP65 | for illuminated pushbutton/keylock switch | plastic | black | | 200-4408-V0 | 0,006 |
| 24x30 mm, hinged, transparent, with means for sealing | IP 40/IP65 | for illuminated pushbutton/keylock switch | plastic | black | 200-6408-V0 | | 0,006 |



sprayproof cover

| | material | 18 x 24 mm Typ-Nr. | 18 x 18 mm Typ-Nr. | |
|---|----------|-----------------------|-----------------------|-------|
| sprayproof cover 24x24 mm, two-part, protection IP 65, illumination exchangeable from the front | PVC | | 200-3009-W0 | 0,003 |
| 24x30 mm, two-part, protection IP 65, illumination exchangeable from the front | silicone | 200-5009-W0 | | 0,003 |



protective guard for illuminated-/pushbutton

for mounting depth 55/70 mm

| | 18 x 24 mm Typ-Nr. | 18 x 18 mm Typ-Nr. | 18 mm dia. Typ-Nr. | |
|--|-----------------------|-----------------------|-----------------------|-------|
| protective guard for illuminated-/pushbutton aluminium anodized colourless, 18x20 mm | | 200-3007-00 | | 0,002 |
| aluminium anodized colourless, 20x24 mm | 200-5007-00 | | | 0,002 |
| aluminium anodized colourless, 20 mm dia. | | | 200-1007-00 | 0,002 |



pressure ring

for indicator IP 65, mounting depth 30/45 mm, obligatory

| | part no. |  |
|--|--------------------|---|
| pressure ring plastic suitable for 24 dia. mm and 24 x 24 mm | 200-8009-W0 | 0,001 |



sealing ring

for front bezel IP 65, 24 dia. mm and 24 x 24 mm

| | degree of protection | material | part no. |  |
|---------------------|----------------------|----------|--------------------|---|
| sealing ring | IP 65 | silicone | 200-9009-W0 | 0,001 |



sealing bulb



for lens IP65, 24 dia. mm and 24 x 24 mm

| | degree of protection | material | part no. |  |
|---------------------|----------------------|----------|--------------------|---|
| sealing bulb | IP 65 | silicone | 200-7009-W0 | 0,001 |



blind plug for 35 mm

for lenses and pushbuttons 35 mm

| | degree of protection | colour |  18 x 24 mm Typ-Nr. |  18 x 18 mm Typ-Nr. | 18 mm dia. Typ-Nr. |  |
|--|----------------------|--------|--|--|-----------------------|---|
| blind plug for 35 mm for mounting hole 16.2 mm dia. | IP 40 | grey | 200-5006-00 | 200-3006-00 | 200-1006-00 | 0,003 |
| | | black | 200-6006-00 | 200-4006-00 | 200-2006-00 | 0,003 |
| | IP 65 | black | 200-6006-W0 | 200-4006-W0 | 200-2006-W0 | 0,003 |



blind plug

for lenses and pushbuttons 30/45/55/70 mm

| | degree of protection | colour | ∅ 18 x 24 mm Typ-Nr. | ∅ 18 x 18 mm Typ-Nr. | 18 mm dia. Typ-Nr. | ∅ 24 x 24 mm Typ-Nr. |  |
|---|----------------------|--------|----------------------------|----------------------------|-----------------------|----------------------------|---|
| blind plug for mounting hole 16.2 mm dia. | IP 40 | grey | 200-5006-00 | 200-3006-00 | 200-1006-00 | | 0,003 |
| | | black | 200-6006-00 | 200-4006-00 | 200-2006-00 | | 0,003 |
| | IP 65 | black | 200-6006-W0 | 200-4006-W0 | 200-2006-W0 | 200-0006-W0 | 0,003 |



spare key

add to the part no., the engraved lock no.

| | use | part no. |  |
|--|---|--------------------|--|
| spare key for standard lock 1001 | for emergency stop switch foolproof with key to release | 240-4001-00 | 0,005 |
| for standard lock B2 300, other lock numbers on request | for keylock switch | 240-2001-00 | 0,005 |
| for standard lock B2 390, other lock numbers on request | for emergency stop switch with key to release | 240-3001-00 | 0,005 |



At ordering indicate marked lock no.

at back

snap-action switching element block for 35 mm

for pushbuttons 35 mm

| | contacts | connection method | part no. | circuit drawing | component layout |  |
|---|-----------------|-------------------|--------------------|-----------------|------------------|---|
| snap-action switching element block for 35 mm | 1 NC + 1 NO | - | 601-0000-00 | 56 | | 0,006 |
| | | P | 601-0000-0P | 56 | 1 | 0,006 |
| | 1 NC + 1 NO + 1 | - | 608-0000-00 | 58 | | 0,006 |
| | | P | 608-0000-0P | 58 | 1 | 0,006 |
| | 1 NC + 1 NO + 2 | - | 609-0000-00 | 59 | | 0,006 |
| | | P | 609-0000-0P | 59 | 1 | 0,006 |
| | 2 NC + 2 NO | - | 602-0000-00 | 57 | | 0,006 |
| | | P | 602-0000-0P | 57 | 1 | 0,006 |



circuit drawings from page 657, component layouts from page 657

lamp element block for 35 mm

for indicator 35 mm

| | diodes | connection method | part no. | circuit drawing | component layout | |
|-------------------------------------|--------|-------------------|--------------------|-----------------|------------------|-------|
| lamp element block for 35 mm | 0 | - | 600-0000-00 | 1 | | 0,005 |
| | | P | 600-0000-0P | 1 | 1 | 0,005 |
| | 1 | - | 606-0000-00 | 60 | | 0,006 |
| | | P | 606-0000-0P | 60 | 1 | 0,006 |
| | 2 | - | 607-0000-00 | 61 | | 0,006 |
| | | P | 607-0000-0P | 61 | 1 | 0,006 |



circuit drawings from page 657, component layouts from page 657

blind element

| | part no. | |
|-------------------------------|--------------------|-------|
| blind element white | 202-0600-00 | 0,002 |



lamp terminal

| | use | part no. | |
|----------------------|---------------------------------|--------------------|-------|
| lamp terminal | for soldering-/plug-in terminal | 270-0000-00 | 0,001 |
| | for PCB terminal | 270-0000-0P | 0,001 |



intermediate section

| | use | part no. | |
|---|---|--------------------|-------|
| intermediate section incl. fixing nut | for illuminated pushbutton 55 mm MG T 1 3/4 | 260-9000-00 | 0,005 |
| | for illuminated pushbutton 70 mm T 5.5 | 260-8000-00 | 0,008 |



snap-action switching element

| | contacts | colour | connection method | material of contacts | part no. | technical drawing | |
|--------------------------------------|-------------|--------|-------------------|----------------------|--------------------|-------------------|-------|
| snap-action switching element | 1 NC + 1 NO | blue | - | gold plated | 201-0500-00 | 59 | 0,003 |
| | | grey | - | gold plated | 201-0800-00 | 59 | 0,003 |
| | | | P | gold plated | 221-0800-0P | 59 | 0,003 |
| | | green | - | gold plated | 201-0400-00 | 59 | 0,003 |



technical drawings from page 642

holder for 2 switching elements

| | use | material | part no. |  |
|--|--|----------|--------------------|---|
| holder for 2 switching elements | push-pull illuminated switch | plastic | 270-2000-00 | 0,001 |
| | for pushbutton 35 mm, keylock-/selector switch 45 mm | plastic | 270-3000-00 | 0,001 |



holder for 3 switching elements

| | use | material | part no. |  |
|--|---------------------------------------|-----------------|--------------------|---|
| holder for 3 switching elements | for illuminated-/pushbuttons 55-70 mm | stainless steel | 270-1000-00 | 0,001 |



spring with pin

for maintained version at the intermediate section

| | use | part no. |  |
|------------------------|-------------------------------------|--------------------|---|
| spring with pin | for illuminated pushbutton 55/70 mm | 260-0010-00 | 0,001 |



PCB plug-in base

| | for | pin orientation | part no. |  |
|---|------------------------------|-----------------|--------------------|---|
| PCB plug-in base lamp terminal 0.5 mikron Au incl. lamp terminal 0.5 mikron Au | indicator 35/55/70 mm | angled | 280-0200-00 | 0,006 |
| | | straight | 280-0100-00 | 0,005 |
| | 1NC + 1NO for 35/45 mm | angled | 280-1210-00 | 0,006 |
| | | straight | 280-1110-00 | 0,005 |
| | 1NC + 1NO for 55/70 mm | angled | 280-1200-00 | 0,006 |
| | | straight | 280-1100-00 | 0,005 |
| | 2NC + 2NO for 35/45/55/70 mm | angled | 280-2200-00 | 0,006 |
| | | straight | 280-2100-00 | 0,005 |
| | 3NC + 3NO for 55/70 mm | angled | 280-3200-00 | 0,006 |
| | | straight | 280-3100-00 | 0,005 |

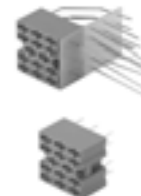

multi-plug housing

| | part no. |  |
|---|--------------------|---|
| multi-plug housing for flat connector with locating tongue with 14 terminal possibilities, 10 terminals plugable max. | 280-0000-00 | 0,002 |



cable shoe

| | use | locating tongue | wire cross-section of terminal | connection method | part no. |  |
|---|--------------------------------------|-----------------|--------------------------------|-------------------|--------------------|---|
| cable shoe | for multi-plug housing (280-0000-00) | with | 0.1 - 0.25 mm& | - 2.8 x 0.5 mm | 280-0001-00 | 0,001 |
| | | | 0.5 - 1.00 mm& | - 2.8 x 0.5 mm | 280-0002-00 | 0,001 |
| as per VDE 0630 use with insulation socket (280-0010-00) | for insulation socket (280-0010-00) | without | 0.2 - 0.75 mm& | - 2.8 x 0.5 mm | 280-0003-00 | 0,001 |



connector with two outputs

| | use | connection method | part no. |  |
|----------------------------|------------------------------|-------------------|--------------------|---|
| connector with two outputs | for cable shoe (280-0003-00) | - 2.8 x 0.5 mm | 280-0004-00 | 0,001 |



insulation socket

| | part no. |  |
|--|--------------------|---|
| insulation socket for connector without locating tongue (280-0003-00) | 280-0010-00 | 0,001 |



for illumination

filament lamp MG T 1 3/4

| | voltage/current | part no. |  |
|--------------------------|-----------------|---------------------|---|
| filament lamp MG T 1 3/4 | 14 V / 80 mA | 10-1310.1319 | 0,001 |
| | 28 V / 40 mA | 10-1313.1249 | 0,001 |
| | 36 V / 30 mA | 10-1316.1209 | 0,001 |
| | 48 V / 25 mA | 10-1319.1199 | 0,001 |
| | 6.3 V / 200 mA | 10-1307.1369 | 0,001 |
| | 60 V / 20 mA | 10-1320.1179 | 0,001 |



filament lamp T 5.5

| | voltage/current | part no. |  |
|---------------------|-----------------|---------------------|---|
| filament lamp T 5.5 | 6 V / 200 mA | 10-1106.1369 | 0,001 |
| | 12 V / 100 mA | 10-1109.1329 | 0,001 |
| | 24 V / 50 mA | 10-1112.1279 | 0,001 |
| | 36 V / 35 mA | 10-1116.1229 | 0,001 |
| | 48 V / 25 mA | 10-1119.1199 | 0,001 |



LED MG T 1 3/4

| | number of chips | voltage/current | colour | part no. |  |
|--|------------------|------------------|---------------------|---------------------|---|
| LED MG T 1 3/4 with built-in protective diode | 6 | 6 VDC / 45 mA | yellow | 10-5306.3254 | 0,001 |
| | | | green | 10-5306.3255 | 0,001 |
| | | | red | 10-5306.3252 | 0,001 |
| | | 12 VDC / 25 mA | yellow | 10-5309.3204 | 0,001 |
| | | | green | 10-5309.3205 | 0,001 |
| | | | red | 10-5309.3202 | 0,001 |
| | | 24 VDC / 12.5 mA | yellow | 10-5312.3134 | 0,001 |
| | | | green | 10-5312.3135 | 0,001 |
| | | | red | 10-5312.3132 | 0,001 |
| | 48 VDC / 12.5 mA | yellow | 10-5319.3104 | 0,001 | |
| | | green | 10-5319.3105 | 0,001 | |
| | | red | 10-5319.3102 | 0,001 | |



Note:
For optimal illumination we strongly recommend using our new single-chip LEDs.

For new designs, only the new single-chip LEDs should be chosen. They can be found on page 669.

LED T 5.5

| | number of chips | voltage/current | colour | part no. |  |
|---|-----------------|------------------|--------|---------------------|---|
| LED T 5.5 with built-in protective diode Note: For optimal illumination we strongly recommend using our new single-chip LEDs. For new designs, only the new single-chip LEDs should be chosen. They can be found on page 669. | 6 | 6 VDC / 45 mA | yellow | 10-5106.3254 | 0,001 |
| | | | green | 10-5106.3255 | 0,001 |
| | | | red | 10-5106.3252 | 0,001 |
| | | 12 VDC / 25 mA | yellow | 10-5109.3204 | 0,001 |
| | | | green | 10-5109.3205 | 0,001 |
| | | | red | 10-5109.3202 | 0,001 |
| | | 24 VDC / 12.5 mA | yellow | 10-5112.3144 | 0,001 |
| | | | green | 10-5112.3145 | 0,001 |
| | | | red | 10-5112.3142 | 0,001 |
| | | 48 VDC / 12.5 mA | yellow | 10-5119.3134 | 0,001 |
| | | | green | 10-5119.3135 | 0,001 |
| | | | red | 10-5119.3132 | 0,001 |



diode element

| | diodes | colour | connection method | part no. |  |
|---------------------------------------|--------|--------|-------------------|--------------------|---|
| diode element diode 1N/4007 | 1 | red | - | 212-0100-00 | 0,003 |
| | | | P | 222-0100-0P | 0,003 |
| | 2 | red | - | 213-0100-00 | 0,003 |
| | | | P | 214-0100-0P | 0,003 |



capacitor

for lamp voltage reduction

| | value | part no. |  |
|---|---------------|--------------------|---|
| capacitor use with 60 V/20 mA, 50 Hz lamp voltage | 220 V/0.27 µF | 300-0090-00 | 0,004 |



Please keep to the country specific security rules.

series resistor

for lamp voltage reduction

| | value | part no. |  |
|---|----------------|--------------------|---|
| series resistor use with 60 V / 20 mA lamp rating | 100 V / 2.7 kΩ | 300-0010-00 | 0,003 |
| | 125 V / 3.3 kΩ | 300-0020-00 | 0,003 |
| | 145 V / 4.7 kΩ | 300-0030-00 | 0,003 |
| | 230 V / 8.2 kΩ | 300-0040-00 | 0,003 |
| | 240 V / 10 kΩ | 300-0050-00 | 0,003 |



Please keep to the country specific security rules.

terminal plate empty

for fitting with series resistors and capacitors

| | no. of spaces | part no. |  |
|---|---------------|--------------------|---|
| terminal plate empty 125 x 60 x 15 mm | 10 spaces | 300-0110-00 | 0,045 |
| 187.5 x 60 x 15 mm | 15 spaces | 300-0115-00 | 0,090 |
| 250 x 60 x 15 mm | 20 spaces | 300-0120-00 | 0,095 |
| 62.5 x 60 x 15 mm | 5 spaces | 300-0105-00 | 0,025 |



for emergency stop switch

label for emergency stop switch

| | degree of protection | marking | 43 mm dia. Typ-Nr. |  |
|---|----------------------|------------|-----------------------|---|
| label for emergency stop switch yellow, other constructions on request | IP 40 | in German | 200-1300-02 | 0,002 |
| | | in English | 200-1300-03 | 0,002 |
| | | in French | 200-1300-04 | 0,002 |
| | | without | 200-1300-01 | 0,002 |
| | IP 65 | in German | 200-1300-W2 | 0,002 |
| | | in English | 200-1300-W3 | 0,002 |
| | | in French | 200-1300-W4 | 0,002 |
| | | without | 200-1300-W1 | 0,002 |



slow-make switching element for emergency stop switch

| | contacts | colour | connection method | material of contacts | part no. | technical drawing |  |
|---|----------|--------|-------------------|----------------------|--------------------|-------------------|---|
| slow-make switching element for emergency stop switch | 1 NC | grey | - | gold plated | 211+0800-00 | 60 | 0,003 |
| | | | P | gold plated | 231+0800-0P | 60 | 0,003 |



technical drawings from page 642

dismantling tool for emergency stop switch foolproof

| | part no. |  |
|--|--------------------|---|
| dismantling tool for emergency stop switch foolproof | 300-0017-00 | 0,004 |



assembling

fixing nut

for standard mounting

| | use | panel thickness | colour | part no. |  |
|-----------------------|-----------------------------|-----------------|--------|--------------------|---|
| fixing nut plastic | for mounting depth 30-70 mm | 1-3 mm | grey | 260-0001-00 | 0,001 |
| | | 3-5 mm | grey | 260-0002-00 | 0,001 |
| | | 5-7 mm | grey | 260-0005-00 | 0,001 |
| | for mounting depth 35 mm | 1-3 mm | black | 260-0003-00 | 0,001 |



fixing nut for flush mounting

| | use | panel thickness | colour | part no. |  |
|---------------------------------------|-----------------------------|-----------------|--------|--------------------|---|
| fixing nut for flush mounting plastic | for mounting depth 41/44 mm | 1-3 mm | black | 260-0003-00 | 0,001 |
| | for mounting depth 39-79 mm | 3-5 mm | grey | 260-0002-00 | 0,001 |



location strip

for indicators, illuminated/push buttons, push-pull illuminated button, buzzer, mushroom-head cap, key and selector switches and emergency button 55-70 mm IP 40 / IP 65 designs

| | use | part no. |  |
|---|------------------|--------------------|---|
| location strip anti-twisting, in-line arrays or single switches | graduation 18 mm | 260-0020-00 | 0,001 |
| | graduation 24 mm | 260-0021-00 | 0,001 |



lens remover

| | part no. |  |
|--------------|--------------------|---|
| lens remover | 300-0001-00 | 0,012 |



lamp/LED remover

| | part no. |  |
|------------------|--------------------|---|
| lamp/LED remover | 300-0002-00 | 0,003 |

Warning:
when replacing lamps/LED a switching process can be triggered!



mounting tool

| | part no. |  |
|---|--------------------|---|
| mounting tool for tightening (or loosening) fixing nuts (at dismantled element block) | 300-0003-00 | 0,007 |



contact element pliers

for block mounting

| | part no. |  |
|---|--------------------|---|
| contact element pliers for dismantling the switching elements off the holder for 3 switching elements | 300-0005-00 | 0,013 |



jaw spanner

| | part no. |  |
|---|--------------------|---|
| jaw spanner for tightening (or loosening) fixing nuts and dismantling of the element blocks (mounting depth 35-70 mm) | 300-0004-00 | 0,003 |



cable shoe remover

| | part no. |  |
|---|--------------------|---|
| cable shoe remover for removing the connector from the multi-plug housing (280-0000-00) | 300-0006-00 | 0,001 |



Switching system

Self-cleaning, double-break slow-make element with four-path contacts (contact opening width 2 x 1.5 mm). The slow-make elements are constructed as per DIN EN 60947-5-1.

Materials

Mushroom-head cap

Polyamide PA

Actuator housing

Polyetherimide PEI, self-extinguishing

Switching element

Polyamide PA
Polysulfone PSU

Contact material

Silver

Connections

Solder/plug-in terminal

max. wire diameter: 2 wires of 1 mm
max. wire cross-section: 1 strand at 0.75 mm²

Connection

2.8 x 0.5 mm

Mechanical characteristic values

Actuating travel

EMERGENCY button 10 mm

Actuating force

max. 65 N (measured on mushroom-head cap of emergency button)

Self-aligning torque

15 Ncm

Shock resistance

(single impact, half-sinusoidal)
50 g, 11 ms as per IEC 512-4

Resistance to vibration

(sinusoidal)
10 g, at 10- 2000- 10- Hz
Amplitude 0.75 mm as per IEC 512-4

Rebound time

<= 2 ms

Degree of pollution

3

Protection class

Front side IP 65
Switching element IP 40

Ambient temperature

-25°C as per DIN EN 60068-2-1
+55°C as per DIN EN 60068-2-2

Storage temperature

-40°C to +85°C

Mechanical service life

EMERGENCY button 50,000 operations

Electrical characteristic values

Switch rating

Silver contact
(Solder/plug-inmin. 20 VAC, 10 mA
connection)max. 250 VAC, 5 A

Service category

| Rated service voltage | Rated service current (inductive) | |
|-----------------------|-----------------------------------|-------|
| | AC 13 | AC 14 |
| 250 VAC | 3 A | 2 A |
| 120 VAC | 5 A | 3 A |
| 60 VAC | 6 A | 4 A |
| 24 VAC | 6 A | 5 A |

Service category

| Rated service voltage | Rated service current | |
|-----------------------|-----------------------|-------|
| | resistive | DC 13 |
| 240 VDC | 0.5 A | 0.2 A |
| 110 VDC | 0.7 A | 0.4 A |
| 60 VDC | 2.0 A | 1.0 A |
| 24 VDC | 6.0 A | 2.0 A |

Volume resistivity

New value for:
Silver contact
<= 50 m Ω
as per IEC 512-2 Test 5

Rated insulation voltage Ui

300 VAC

Electric strength

as per VDE 0660 (IEC 512-2-11)
4000 VAC, 50 Hz, 1 min between connections and earth

Overvoltage category

III

Thermal steady current

I_{th2} solder/plug-in connection 5 A

Max. permissible current for continuous operation and ambient temperature which does not exceed the specified max. values

Max. permissible rated current

for series-connected blow-out fuse
10 A gL

Electrical service life

Slow-make element 6050 operations

Approvals

- CE (declaration of conformity)
- CSA
- UR
- VDE
- ENEC

Right reserved to change all technical specifications.

EMERGENCY slow-make element

General

Is equipped with rigid contact link. The slow-make element opens positively and simply consists of a double-break NC. The multilayer contacts are designed for universal use and are gilded with a 2 μ m gold coating. The EMERGENCY slow-make element is designed according to DIN EN 60947-5-1.

Material

Housing

Duroplast (DAP)
with fireproofing as per UL 94 V0

Contact

AgNi, 2 μ m gilded

Contact carrier

Brass or CuBe

Connection

Brass gilded
2.8 x 0.5 mm solder/plug-in or PCB connection
1 mm² max. connection cross-section

Mechanical characteristic values

Ambient temperature

-25°C as per DIN EN 60068-2-1
+55°C as per DIN EN 60068-2-2

Storage temperature

-40°C to +85°C

Mechanical service life

8000 switching cycles

Contact opening width

> 2 x 1.5 mm

EMERGENCY switching element

Electrical characteristic values

Rated voltage

250 V / 50 Hz

Service category

AC 15: 250 V / 1 A

Rated insulation voltage U_i

250 V

Series-connected blow-out fuse

5 A gL

Conventional thermal current I_{th}

5 A

Electrical service life

8000 switching cycles AC 15: 250 V / 1 A

Diode element

General

Has no switching function. The diodes are soldered into the switching element housing between the contact connections.

Material

Housing

Thermoplast (PETP)
with fireproofing as per UL 94 V0

Connection

Brass gilded
2.8 x 0.5 mm solder/plug-in or PCB connection
1 mm² max. connection cross-section

Electrical characteristic values

Diode

1 N / 4007, $I_{max.} = 1$ A, $U_{block} = 1000$ V

Dummy element

General

Is inserted in empty places in the switching element block. The dummy element has no metal parts and no electrical function.

Material

Housing

Thermoplast (PET)
with fireproofing as per UL 94 V0

Alarm buzzer

Operating voltage

Current consumption

approx. 13 mA

Reverse-connect protection

yes

Acoustics

approx. 84 dB at 0.1 m

Frequency

approx. 2.3 kHz

Unit

General

In accordance with the low-voltage directive, our products are labelled with the CE mark.

SWISSTAC switches are modularly designed and are divided into the following three groups:

1. Front

Man-switch interface and state detector

2. Intermediate piece

Set and reset device, bulb holder, latching function

3. Switching element block

Up to five switching elements can be integrated in a switching element block.

Each switch is tested fully mounted. Electrical output and service life are determined by the switching element. Front and intermediate piece are designed for maximum service life of the switching element. They determine in what way the switches are protected against external influences. The type approvals relate to the complete switches. The approval regulations are UL 1054, VDE 0630 (EMERGENCY button VDE 0660), CSA 22.2.

Mechanical characteristic values

Resistance to vibration

tested as per DIN EN 60068-2-6 (10 g to 2000 Hz)

Shock resistance

tested as per DIN EN 60068-2-27 (semi-sinusoidal, 50 g during 11 ms) (single impacts, semi-sinusoidal)
15 g during 11 ms as per DIN EN 60068-2-29

Approvals

- CE (declaration of conformity)
- CSA
- UR
- VDE
- ENEC

Front

General

The front notifies the switching status, serves for activation of the switch and determines its type of protection. The form and colours of the front also characterise the appearance of the entire switching system. With the exception of the front \varnothing 18 mm of the illuminated pushbuttons 55 and 70 mm, all front frame elements have activation protection.

Material

Lens

Thermoplast (PC)

Front bezel

Thermoplast with fireproofing (PBT)

Actuator 35 mm

Thermoplast with fireproofing (PBT)

Lock housing

Thermoplast with fireproofing (PBT)

Lock cylinder

Rynite reinforced with carbon fibre (PBT + CF)

Seal bellows (IP 65)

Silicon

Mechanical characteristic values

Protection class

as per IEC 529 (front side)

IP 40

IP 65

IP 67

protection against water

0 = without protection

5 = spray water

7 = watertight up to 1 m WS

protection against solid matter of varying size

4 = protection against solid matter $> \varnothing$ 1 mm

6 = dust-tight

see "Intermediate piece" for other properties

Intermediate piece

General

The intermediate piece serves for several properties such as the setting and resetting functions, and the latching device. In addition, all parts necessary for a complete switch are fastened to the intermediate piece. These include the front parts, switching element block and lamps.

Material

Housing

Thermoplast with fireproofing (PC)

Lamp connection

Nickel silver 2.8 x 0.5 mm

Electrical characteristic values

Electric strength

3750 V AC, 1 min. as per DIN EN 61058-1

Insulation resistance

$> 10^{12} \Omega$ as per IEC 512-2-10

Illumination

Lamp voltage

6 V to 125 V as per CSA

6 V to 60 V as per VDE, UL, DEMKO

Lamp output

max. 1.2 W

Mechanical characteristic values

Ambient temperature

-25°C as per DIN EN 60068-2-1

+55°C as per DIN EN 60068-2-2

Storage temperature

-40°C to +85°C

Service life

> 2 x 10⁶ activations of the illuminated pushbuttons

> 5 x 10⁴ activations of the key and selector switches

> 8 x 10³ activations of the emergency button

> 2.5 x 10⁵ activations of the push-pull illuminated button

Switching element block

General

Up to five independent switching elements can be integrated in the switching element block as a switching unit. There are four different types of switching element available.

1. Snap-action switching element
2. Emergency button switching element
3. Diode element
4. Dummy element

Material

Bracket for three switching elements

rust-free chromium steel

Bracket for two switching elements

Thermoplast with fireproofing (PA6)

Lamp connection

CuBe, 2 µm Optalloy 2.8 x 0.5 mm solder/plug-in connection

Electrical characteristic values

Electric strength

2000 V AC, 50 Hz 1 min. (functional isolation)

Insulation resistance

> 10¹² W

In accordance with the VDE 0630 regulation, blade receptacles must be used with the insulation socket 280-0010-00.

Snap-action switching element

General

Is equipped with double-break jump contacts. Owing to the large cleaning path, outstanding self-cleaning is possible. The multilayer contacts are designed for universal use. They are gilded with a 2 µm gold coating. Each snap-action switching element comprises an NC (normally closed contact) and an NO (normally open contact)

Material

Housing

Thermoplast (PETP)
with fireproofing as per UL 94 V0

Contact

AgNi, 2 µm gilded

Contact carrier

Brass or CuBe

Connection

Brass gilded

2.8 x 0.5 mm solder/plug-in or PCB connection

1 mm² max. connection cross-section

Mechanical characteristic values

Ambient temperature

-25°C to +55°C

-25°C as per DIN EN 60068-2-1

+55°C as per DIN EN 60068-2-2

Storage temperature

-40°C to +85°C as per DIN EN 60068

Mechanical service life

2 x 10⁵ switching cycles

Contact opening width

2 x 0.65 mm

Contact cleaning path

2 x 0.6 mm

Rebound time

typically 0.5 ms

Activation force

approx. 2 N for each snap-action switching element

Electrical characteristic values

Thermal steady current I_{th} max.

6 A, up to 3-pole switching element block

4 A, for 4- and 5-pole switching element blocks

Limited on thermal grounds to I_{max} = 4 A

Volume resistivity

< = 50 m Ω typically, new statically

Electrical load as per DIN EN 61058-1

5(1.5) A 250 V up to 3 switching elements

4(1) A 250 V for 4 or 5 switching elements,

min. AC / DC: 5 V / 1 mA

Electrical service life

> 10⁴ switching operations

DIN EN 61058-1250 V, (1.5) A

DIN EN 60947-5-1 AC 12:250 V / 0.5 A

110 V / 2 A

75 V / 5 A

60 V / 6 A

48 V / 6 A

24 V / 6 A

Snap-action switching element

Out 4.7

In 3.6

technical drawings

1 indicator actuator 35 mm, pushbutton-/illuminated pushbutton actuator 35 mm
page 591, 592

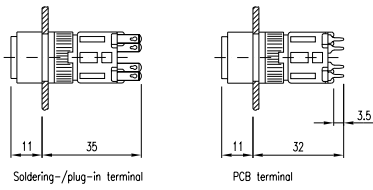

2 indicator 30 - 70 mm, buzzer 30 - 55 mm
page 591, 607

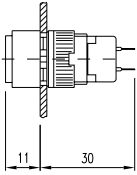

3 indicator 30 - 70 mm
page 591

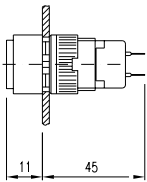

4 indicator 30 - 70 mm, buzzer 30 - 55 mm
page 591, 607

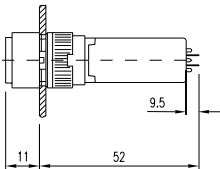

5 indicator 30 - 70 mm, buzzer 30 - 55 mm
page 591, 607

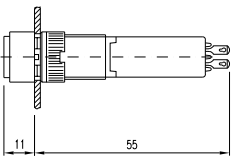

6 indicator 30 - 70 mm
page 591

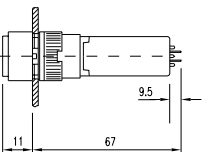

7 indicator 30 - 70 mm

page 591

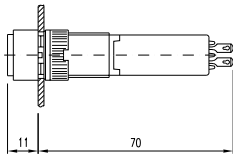

8 illuminated-/pushbutton 55 - 70 mm

page 593

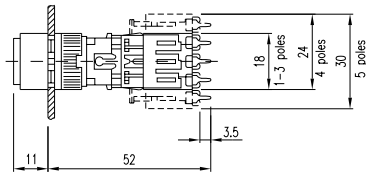

9 illuminated-/pushbutton 55 - 70 mm

page 593

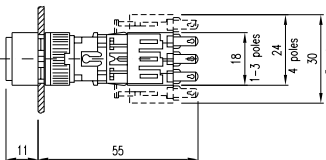

10 illuminated-/pushbutton 55 - 70 mm

page 593

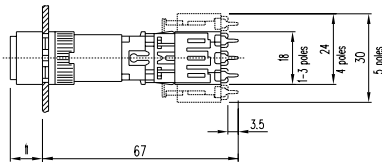

11 illuminated-/pushbutton 55 - 70 mm

page 593

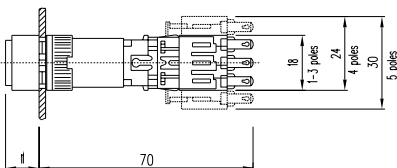

12 emergency stop switch 55 - 70 mm

page 594

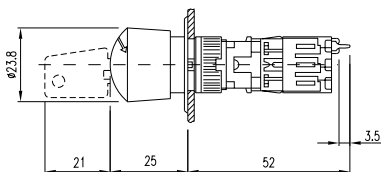

13 emergency stop switch 55 - 70 mm
page 594

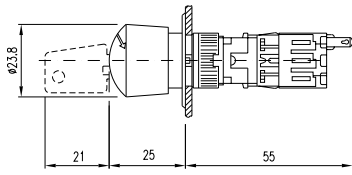

14 emergency stop switch 55 - 70 mm
page 594

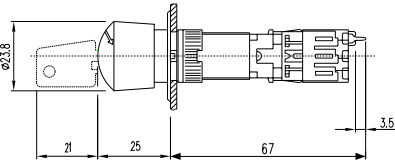

15 emergency stop switch 55 - 70 mm
page 594

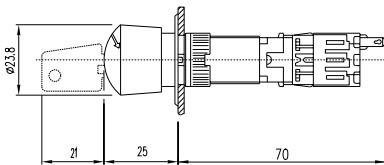

16 emergency stop switch foolproof 41 mm
page 596

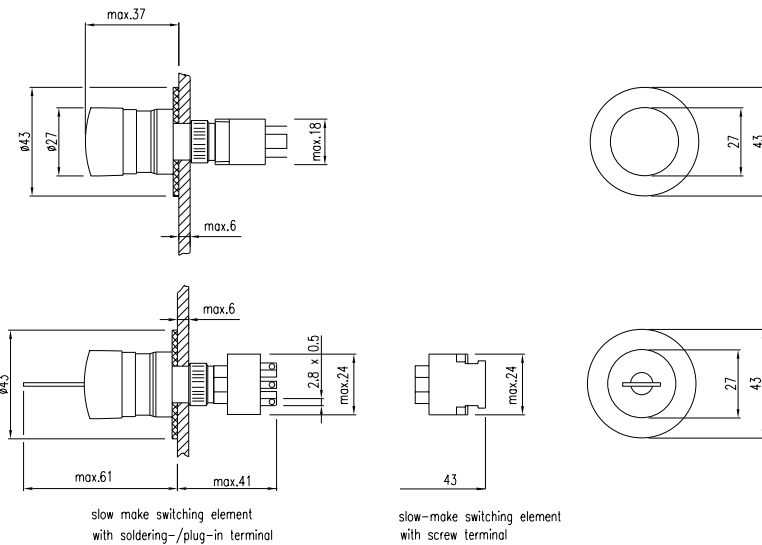

17 pushbutton with mushroom-head cap 55 - 70 mm
page 597

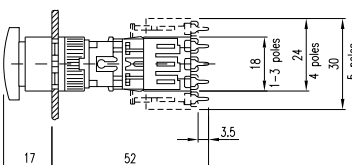

18 pushbutton with mushroom-head cap 55 - 70 mm
page 597

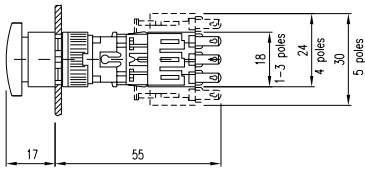

19 pushbutton with mushroom-head cap 55 - 70 mm
page 597

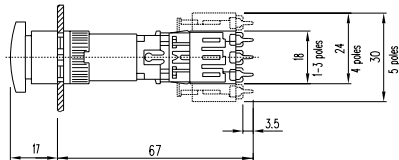

20 pushbutton with mushroom-head cap 55 - 70 mm
page 597

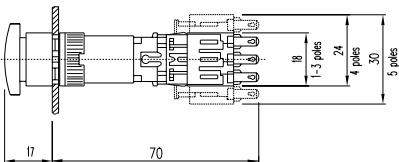

21 keylock switch 2 positions 45 - 70 mm, keylock switch 3 positions 45 mm
page 598, 602

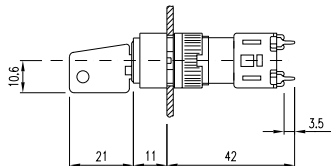

22 keylock switch 2 positions 45 - 70 mm, keylock switch 3 positions 45 mm
page 598, 602

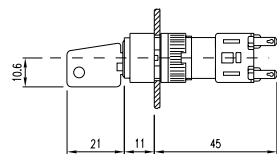

23 keylock switch 2 positions 45 - 70 mm
page 598

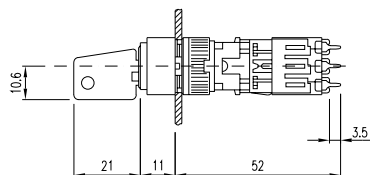

24 keylock switch 2 positions 45 - 70 mm
page 598

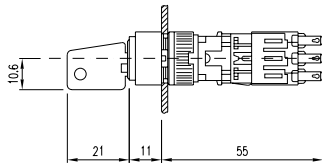

25 keylock switch 2 positions 45 - 70 mm
page 598

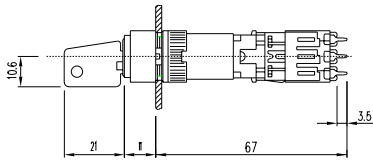

26 keylock switch 2 positions 45 - 70 mm
page 598

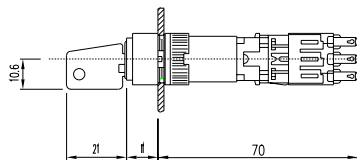

27 selector switch 2 positions 45 - 70 mm, selector switch 3 positions 45 mm
page 603, 606

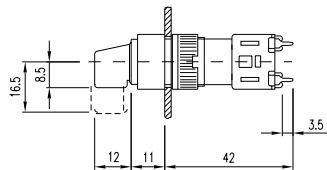

28 selector switch 2 positions 45 - 70 mm, selector switch 3 positions 45 mm
page 603, 606

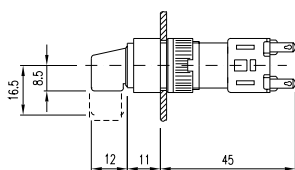

29 selector switch 2 positions 45 - 70 mm
page 603

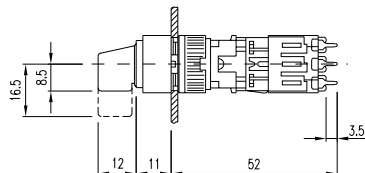

30 selector switch 2 positions 45 - 70 mm
page 603

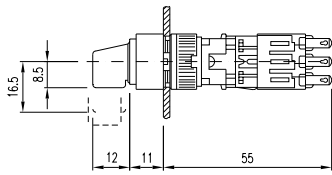

31 selector switch 2 positions 45 - 70 mm
page 603

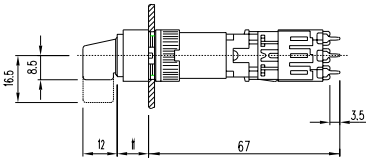

32 selector switch 2 positions 45 - 70 mm
page 603

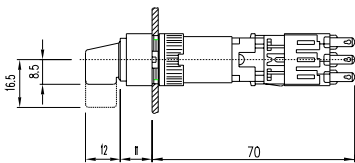

33 push-pull illuminated switch 45 mm
page 607

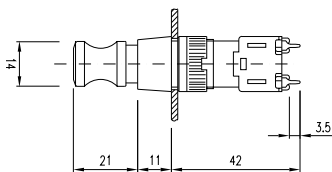

34 push-pull illuminated switch 45 mm
page 607

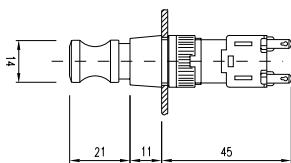

35 indicator actuator 41-44 mm for flush mounting, illuminated-/pushbutton actuator 41-44 mm for flush mounting
page 608, 610

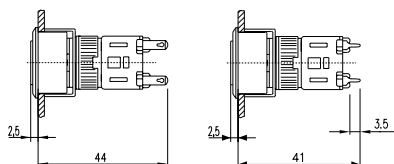

36 indicator for flush mounting 39 - 79 mm, buzzer for flush mounting 39 - 64 mm
page 609, 621

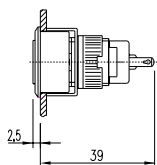

37 indicator for flush mounting 39 - 79 mm
page 609

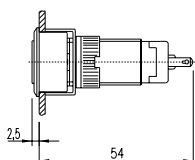

38 indicator for flush mounting 39 - 79 mm, buzzer for flush mounting 39 - 64 mm
page 609, 621

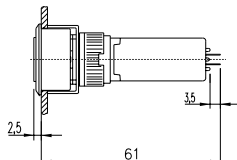

39 indicator for flush mounting 39 - 79 mm, buzzer for flush mounting 39 - 64 mm
page 609, 621

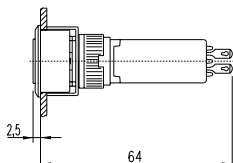

40 indicator for flush mounting 39 - 79 mm
page 609

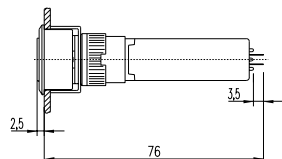

41 indicator for flush mounting 39 - 79 mm
page 609

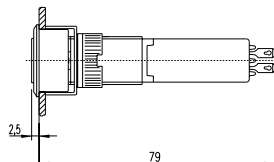

42 pushbutton-/illuminated pushbutton for flush mounting 61 - 79 mm
page 611

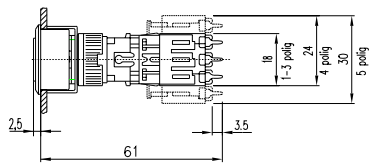

43 pushbutton-/illuminated pushbutton for flush mounting 61 - 79 mm
page 611

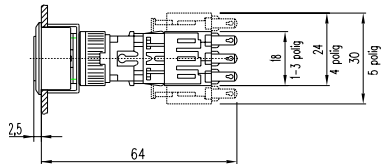

44 pushbutton-/illuminated pushbutton for flush mounting 61 - 79 mm
page 611

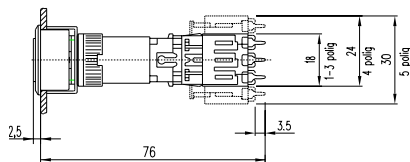

45 pushbutton-/illuminated pushbutton for flush mounting 61 - 79 mm
page 611

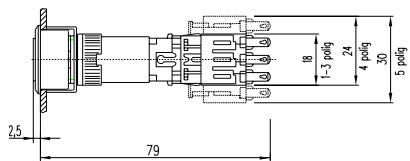

46 keylock switch 2 positions for flush mounting 51 - 79 mm, keylock switch with 3 positions for flush mounting 51 - 54 mm
page 612, 616

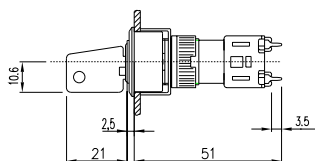

47 keylock switch 2 positions for flush mounting 51 - 79 mm, keylock switch with 3 positions for flush mounting 51 - 54 mm
page 612, 616

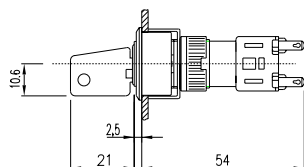

48 keylock switch 2 positions for flush mounting 51 - 79 mm
page 612

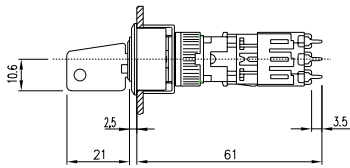

49 keylock switch 2 positions for flush mounting 51 - 79 mm
page 612

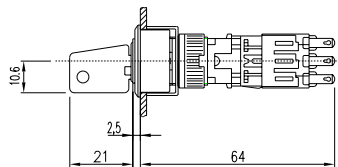

50 keylock switch 2 positions for flush mounting 51 - 79 mm
page 612

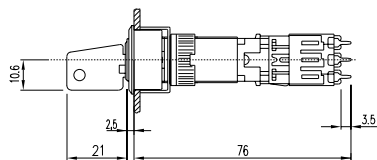

51 keylock switch 2 positions for flush mounting 51 - 79 mm
page 612

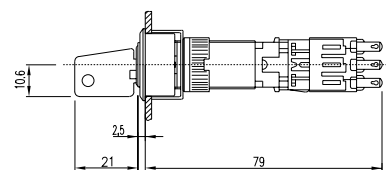

52 selector switch 2 positions for flush mounting 51 - 79 mm, selector switch 3 positions for flush mounting 51 - 54 mm
page 617, 620

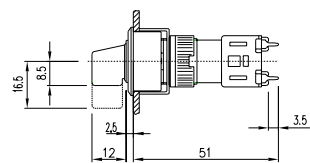

53 selector switch 2 positions for flush mounting 51 - 79 mm, selector switch 3 positions for flush mounting 51 - 54 mm
page 617, 620

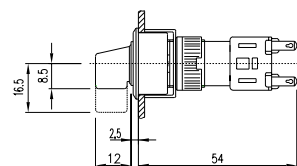

54 selector switch 2 positions for flush mounting 51 - 79 mm
page 617

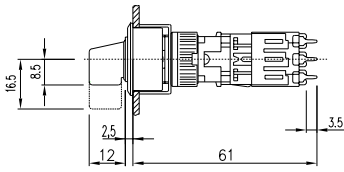

55 selector switch 2 positions for flush mounting 51 - 79 mm
page 617

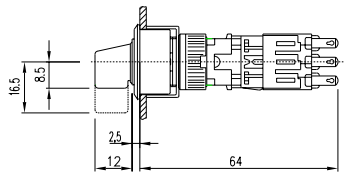

56 selector switch 2 positions for flush mounting 51 - 79 mm
page 617

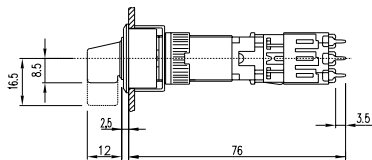

57 selector switch 2 positions for flush mounting 51 - 79 mm
page 617

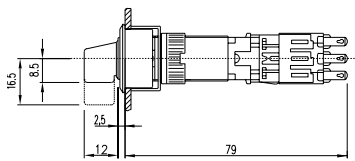

58 protective cover for 35 mm, protective cover for illuminated-/pushbutton 55 - 70 mm
page 628, 629

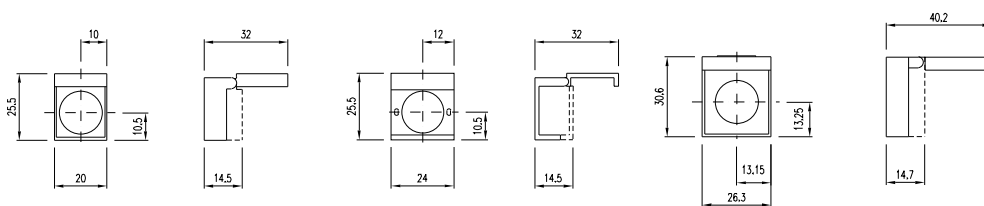

59 snap-action switching element

page 632

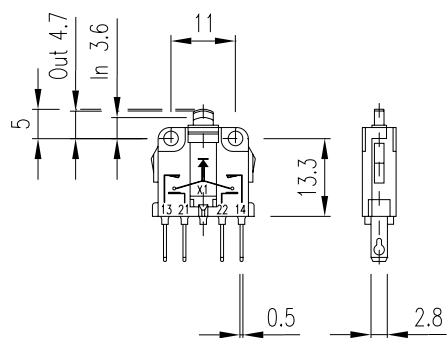

60 slow-make switching element for emergency stop switch

page 636

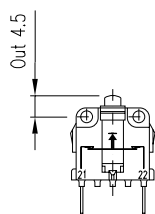

mounting dimensions

1 indicator actuator 35 mm, pushbutton-/illuminated pushbutton actuator 35 mm

page 591, 592

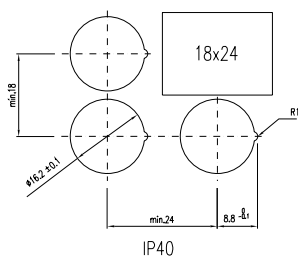
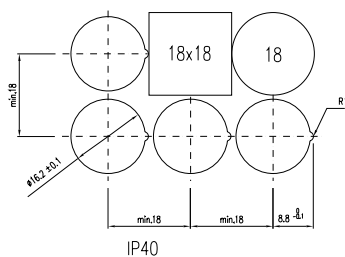

2 indicator actuator 35 mm, pushbutton-/illuminated pushbutton actuator 35 mm

page 591, 592

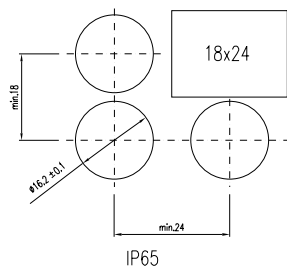
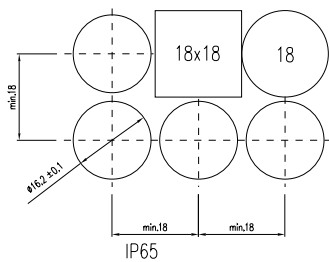

3 indicator 30 - 70 mm, illuminated-/pushbutton 55 - 70 mm
page 591, 593,

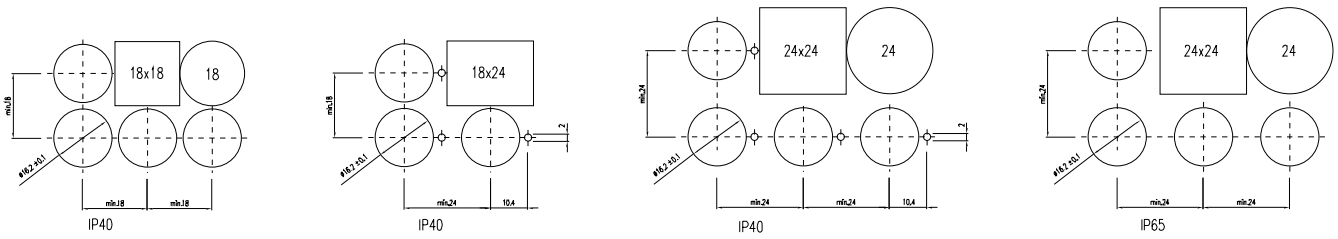

4 emergency stop switch 55 - 70 mm
page 594

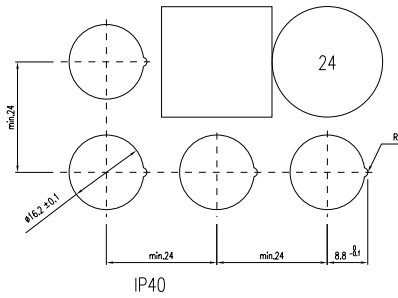

5 emergency stop switch 55 - 70 mm
page 594

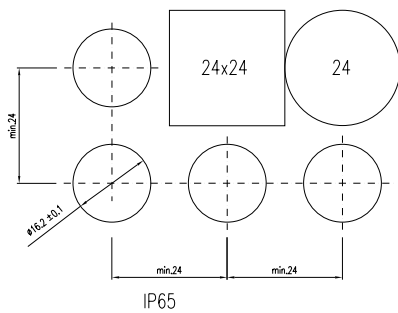

6 emergency stop switch foolproof 41 mm
page 596

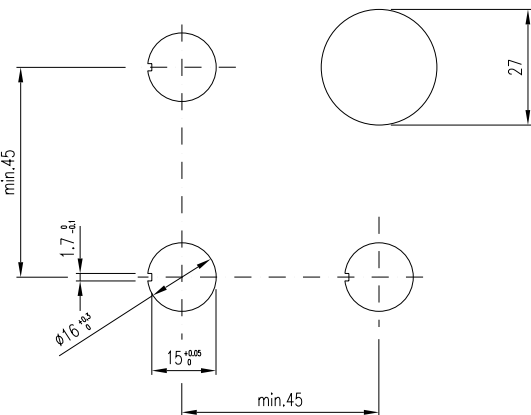

7 pushbutton with mushroom-head cap 55 - 70 mm

page 597

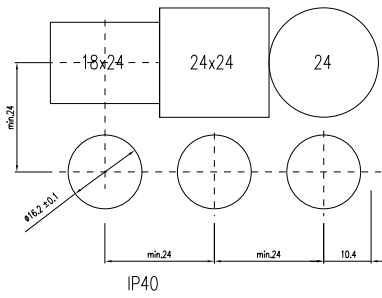

8 keylock switch 2 positions 45 - 70 mm, keylock switch 3 positions 45 mm

598, 602,

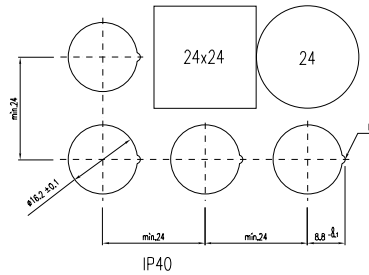
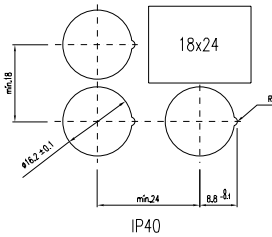
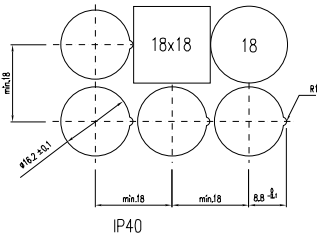

9 keylock switch 2 positions 45 - 70 mm, keylock switch 3 positions 45 mm

page 598, 602

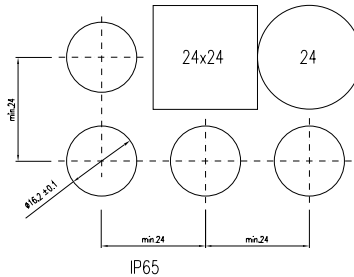
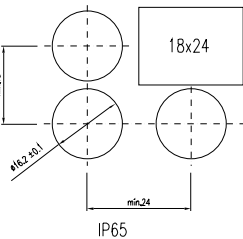
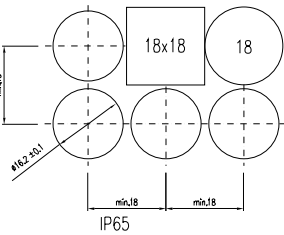

10 selector switch 2 positions 45 - 70 mm, selector switch 3 positions 45 mm

page 603, 606

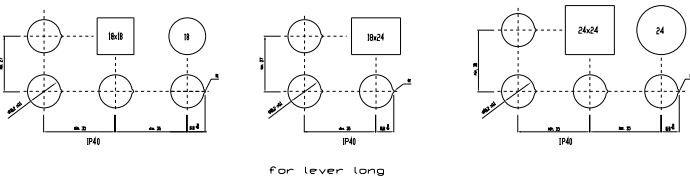

for lever long

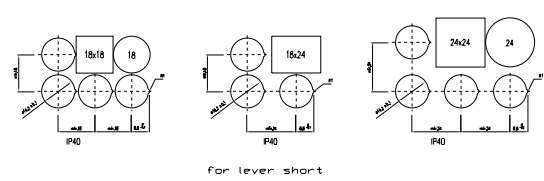

for lever short

11 selector switch 2 positions 45 - 70 mm, selector switch 3 positions 45 mm

page 603, 606

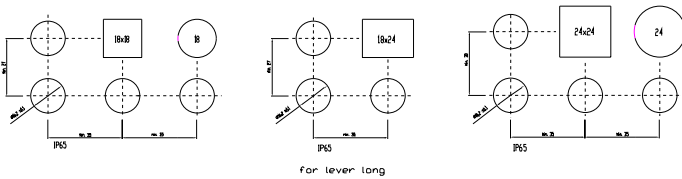

for lever long

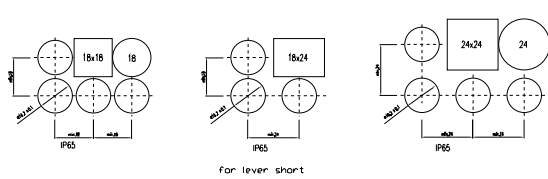

for lever short

12 buzzer 30 - 55 mm

page 607

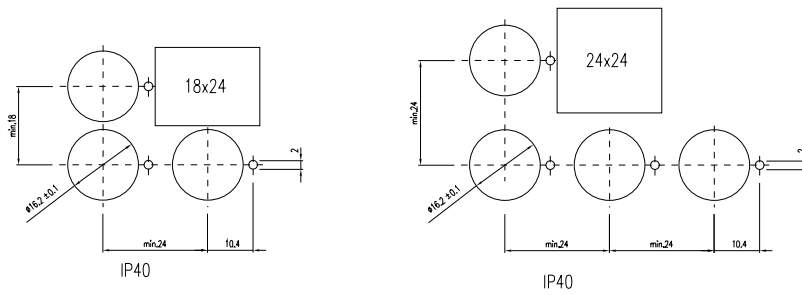

13 push-pull illuminated switch 45 mm

page 607

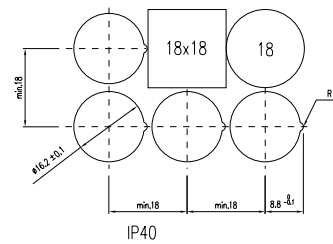

14 indicator actuator 41-44 mm for flush mounting, indicator for flush mounting 39 - 79 mm, illuminated-/pushbutton actuator 41-44 mm for flush mounting, pushbutton-/illuminated pushbutton for flush mounting 61 - 79 mm, keylock switch with 3 positions for flush mounting 51 - 54 mm
page 608, 609, 610, 611, 612, 616

$\varnothing 25\text{mm}$

24 x 30mm

24 x 24mm

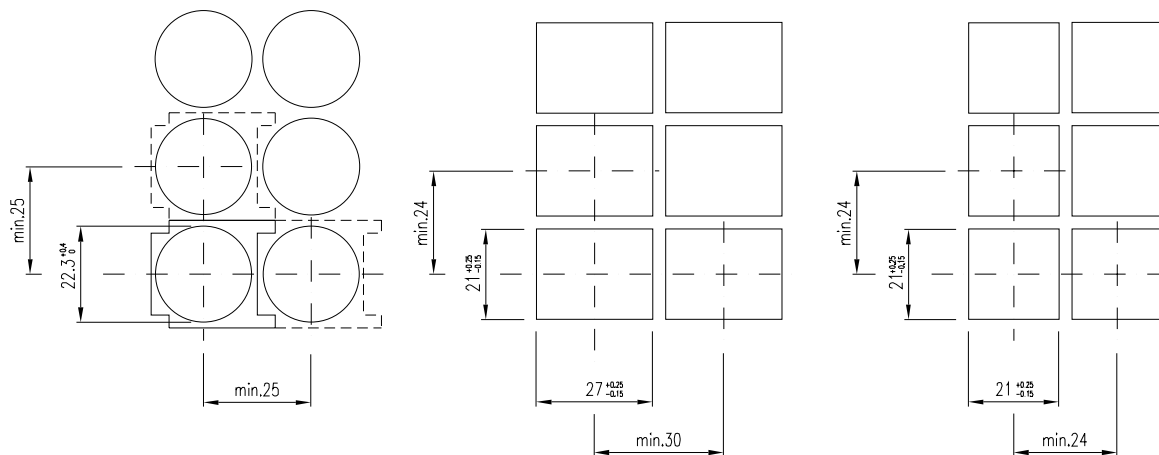

15 selector switch 2 positions for flush mounting 51 - 79 mm, selector switch 3 positions for flush mounting 51 - 54 mm

page 617, 620

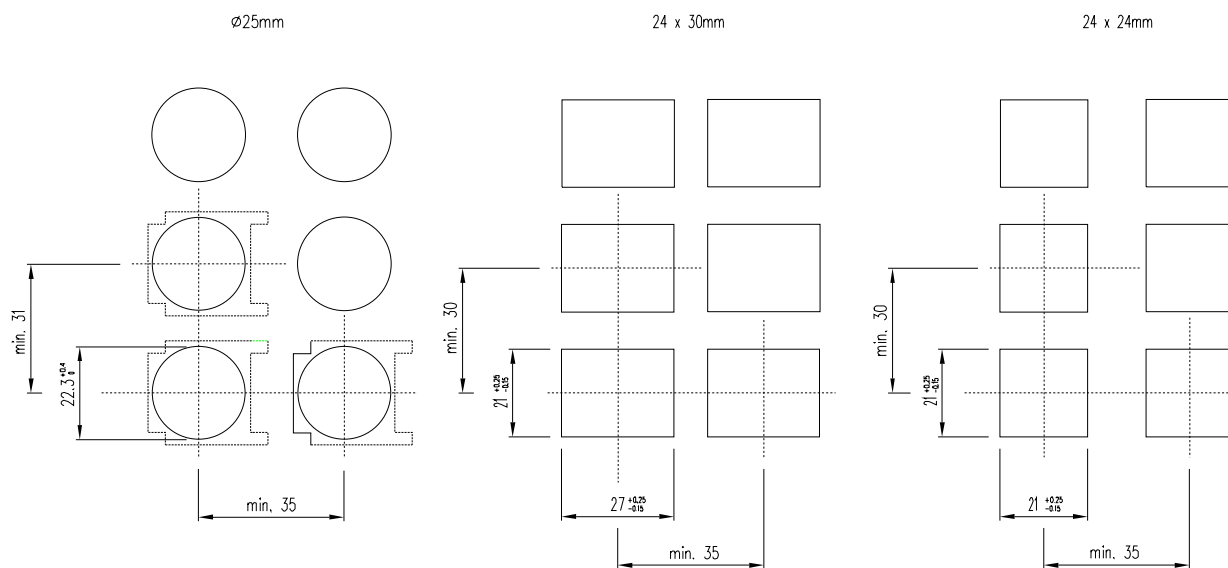

16 buzzer for flush mounting 39 - 64 mm

page 621

24 x 30mm

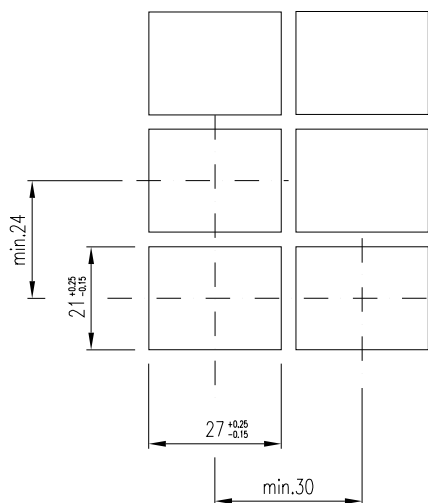

component layouts

1 indicator actuator 35 mm, indicator 30 - 70 mm, pushbutton-/illuminated pushbutton actuator 35 mm, illuminated-/pushbutton 55 - 70 mm, emergency stop switch 55 - 70 mm, pushbutton with mushroom-head cap 55 - 70 mm, keylock switch 2 positions 45 - 70 mm, keylock switch 3 positions 45 mm, selector switch 2 positions 45 - 70 mm, selector switch 3 positions 45 mm, buzzer 30 - 55 mm, push-pull illuminated switch 45 mm, indicator for flush mounting 39 - 79 mm, pushbutton-/illuminated pushbutton for flush mounting 61 - 79 mm, keylock switch 2 positions for flush mounting 51 - 79 mm, keylock switch with 3 positions for flush mounting 51 - 54 mm, selector switch 2 positions for flush mounting 51 - 79 mm, selector switch 3 positions for flush mounting 51 - 54 mm, buzzer for flush mounting 39 - 64 mm, snap-action switching element block for 35 mm, lamp element block for 35 mm

page 591, 591, 592, 593, 594, 597, 598, 602, 603, 606, 607, 607, 609, 611, 612, 616, 617, 620, 621, 631, 632

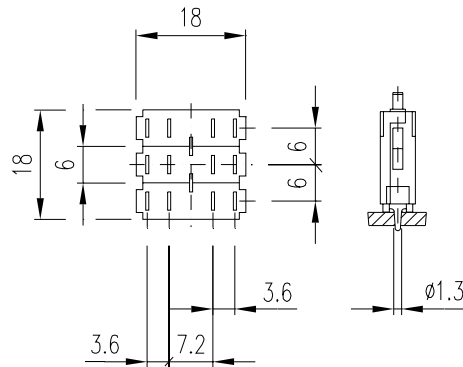

circuit drawings

1 indicator actuator 35 mm, indicator 30 - 70 mm, indicator actuator 41-44 mm for flush mounting, indicator for flush mounting 39 - 79 mm, lamp element block for 35 mm

page 591, 591, 608, 609, 632

x1+



x2-

2 pushbutton-/illuminated pushbutton actuator 35 mm

page 592

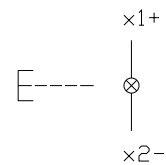

3 pushbutton-/illuminated pushbutton actuator 35 mm

page 59

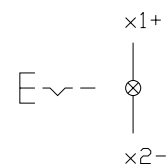

4 illuminated-/pushbutton 55 - 70 mm, pushbutton-/illuminated pushbutton for flush mounting 61 - 79 mm
 page 593, 611,

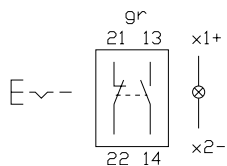

5 illuminated-/pushbutton 55 - 70 mm, pushbutton-/illuminated pushbutton for flush mounting 61 - 79 mm
 page 593, 611

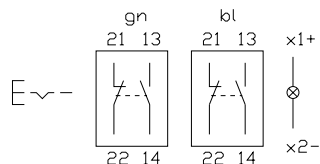

6 illuminated-/pushbutton 55 - 70 mm, pushbutton-/illuminated pushbutton for flush mounting 61 - 79 mm
 page 593, 611

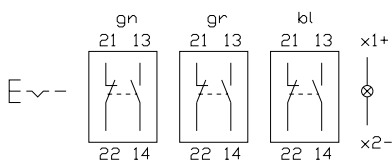

7 illuminated-/pushbutton 55 - 70 mm, pushbutton-/illuminated pushbutton for flush mounting 61 - 79 mm
 page 593, 611

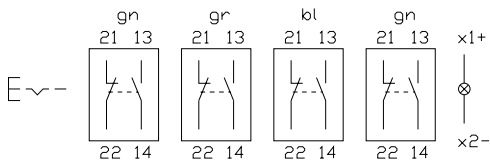

8 illuminated-/pushbutton 55 - 70 mm, pushbutton-/illuminated pushbutton for flush mounting 61 - 79 mm
 page 593, 611

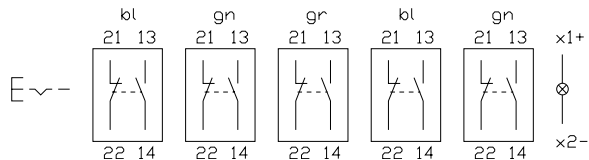

9 emergency stop switch 55 - 70 mm
 page 594

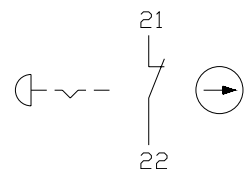

10 emergency stop switch 55 - 70 mm
 page 594

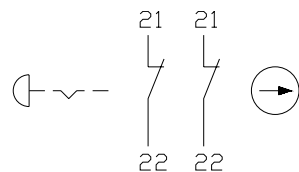

11 emergency stop switch 55 - 70 mm

page 594

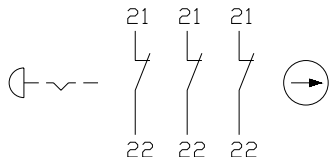

12 emergency stop switch foolproof 41 mm

page 596

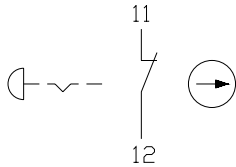

13 emergency stop switch foolproof 41 mm

page 596

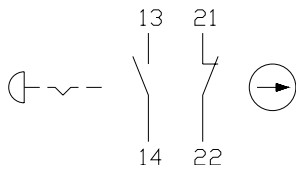

14 emergency stop switch foolproof 41 mm

page 596

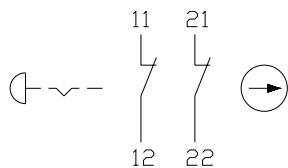

15 pushbutton with mushroom-head cap 55 - 70 mm

page 597

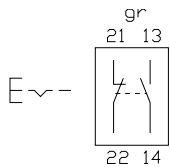

16 pushbutton with mushroom-head cap 55 - 70 mm

page 597

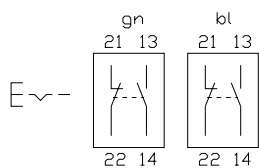

17 pushbutton with mushroom-head cap 55 - 70 mm

page 597

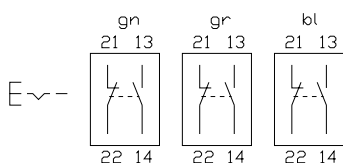

18 pushbutton with mushroom-head cap 55 - 70 mm

page 597

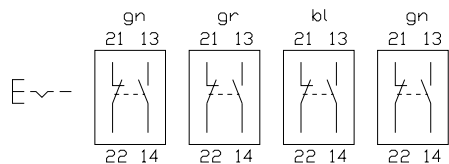

19 pushbutton with mushroom-head cap 55 - 70 mm

page 597

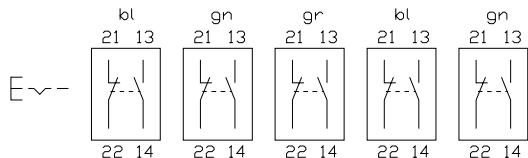

20 keylock switch 2 positions 45 - 70 mm, keylock switch 2 positions for flush mounting 51 - 79 mm

page 598, 612

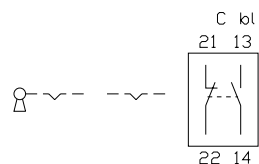

21 keylock switch 2 positions 45 - 70 mm, keylock switch 2 positions for flush mounting 51 - 79 mm

page 598, 612

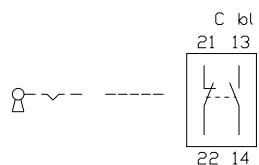

22 keylock switch 2 positions 45 - 70 mm, keylock switch 2 positions for flush mounting 51 - 79 mm

page 598, 612

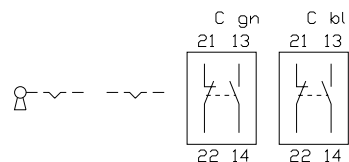

23 keylock switch 2 positions 45 - 70 mm, keylock switch 2 positions for flush mounting 51 - 79 mm

page 598, 612

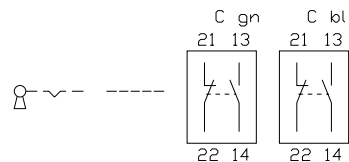

24 keylock switch 2 positions 45 - 70 mm, keylock switch 2 positions for flush mounting 51 - 79 mm

page 598, 612

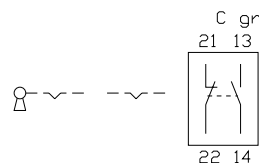

25 keylock switch 2 positions 45 - 70 mm, keylock switch 2 positions for flush mounting 51 - 79 mm
page 598, 612

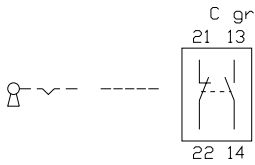

26 keylock switch 2 positions 45 - 70 mm, keylock switch 2 positions for flush mounting 51 - 79 mm
page 598, 612

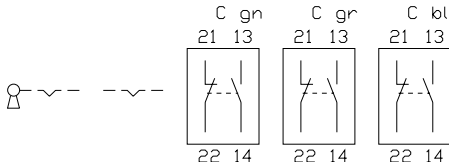

27 keylock switch 2 positions 45 - 70 mm, keylock switch 2 positions for flush mounting 51 - 79 mm
page 598, 612

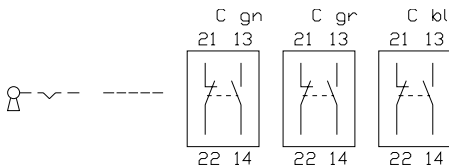

28 keylock switch 2 positions 45 - 70 mm, keylock switch 2 positions for flush mounting 51 - 79 mm
page 598, 612

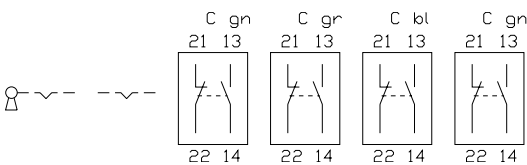

29 keylock switch 2 positions 45 - 70 mm, keylock switch 2 positions for flush mounting 51 - 79 mm
page 598, 612

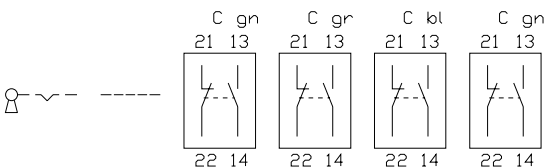

30 keylock switch 2 positions 45 - 70 mm, keylock switch 2 positions for flush mounting 51 - 79 mm
page 598, 612

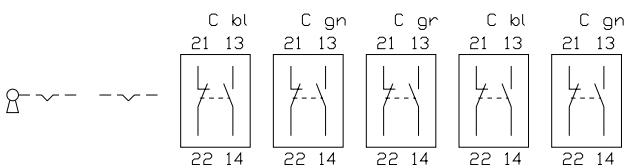

31 keylock switch 2 positions 45 - 70 mm, keylock switch 2 positions for flush mounting 51 - 79 mm
page 598, 612

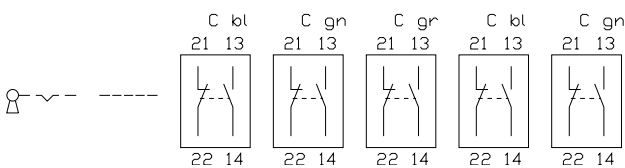

32 keylock switch 3 positions 45 mm, keylock switch with 3 positions for flush mounting 51 - 54 mm
page 602, 616

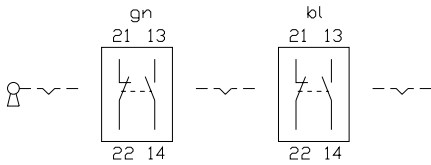

33 keylock switch 3 positions 45 mm, keylock switch with 3 positions for flush mounting 51 - 54 mm
page 602, 616

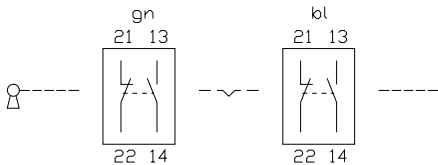

34 keylock switch 3 positions 45 mm, keylock switch with 3 positions for flush mounting 51 - 54 mm
page 602, 616

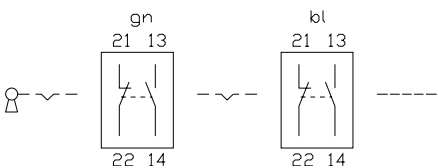

35 keylock switch 3 positions 45 mm, keylock switch with 3 positions for flush mounting 51 - 54 mm
page 602, 616

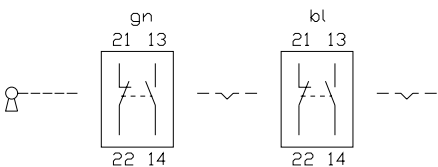

36 selector switch 2 positions 45 - 70 mm, selector switch 2 positions for flush mounting 51 - 79 mm
page 603, 617

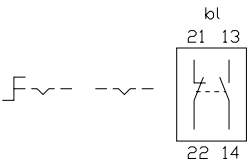

37 selector switch 2 positions 45 - 70 mm, selector switch 2 positions for flush mounting 51 - 79 mm
page 603, 617

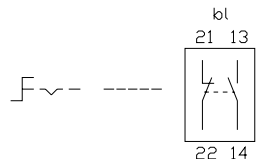

38 selector switch 2 positions 45 - 70 mm, selector switch 2 positions for flush mounting 51 - 79 mm
page 603, 617

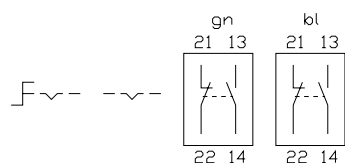

39 selector switch 2 positions 45 - 70 mm, selector switch 2 positions for flush mounting 51 - 79 mm
page 603, 617

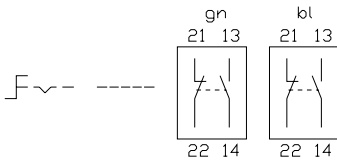

40 selector switch 2 positions 45 - 70 mm, selector switch 2 positions for flush mounting 51 - 79 mm
page 603, 617

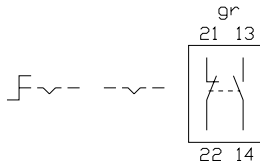

41 selector switch 2 positions 45 - 70 mm, selector switch 2 positions for flush mounting 51 - 79 mm
page 603, 617

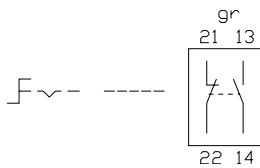

42 selector switch 2 positions 45 - 70 mm, selector switch 2 positions for flush mounting 51 - 79 mm
page 603, 617

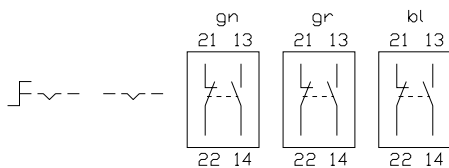

43 selector switch 2 positions 45 - 70 mm, selector switch 2 positions for flush mounting 51 - 79 mm
page 603, 617

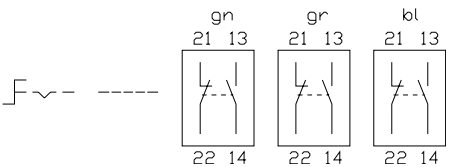

44 selector switch 2 positions 45 - 70 mm, selector switch 2 positions for flush mounting 51 - 79 mm
page 603, 617

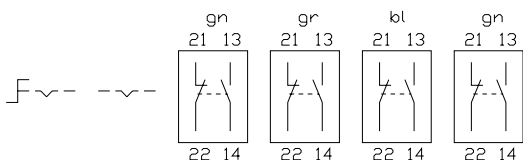

45 selector switch 2 positions 45 - 70 mm, selector switch 2 positions for flush mounting 51 - 79 mm
page 603, 617

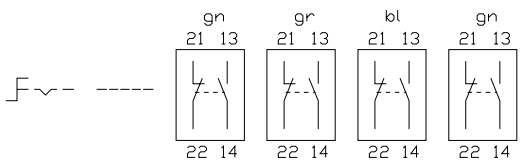

46 selector switch 2 positions 45 - 70 mm, selector switch 2 positions for flush mounting 51 - 79 mm
page 603, 617

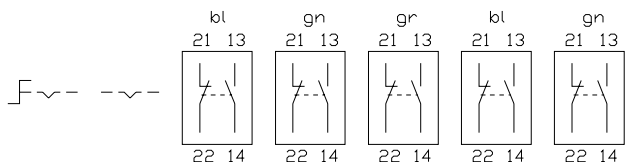

47 selector switch 2 positions 45 - 70 mm, selector switch 2 positions for flush mounting 51 - 79 mm
page 603, 617

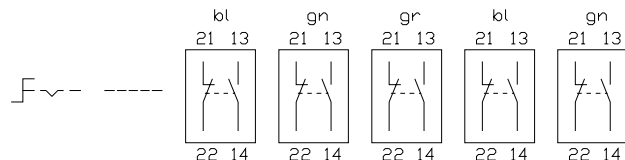

48 selector switch 3 positions 45 mm, selector switch 3 positions for flush mounting 51 - 54 mm
page 606, 620

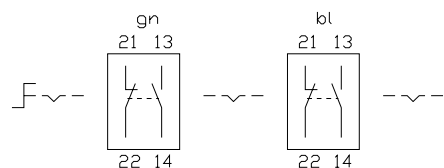

49 selector switch 3 positions 45 mm, selector switch 3 positions for flush mounting 51 - 54 mm
page 606, 620

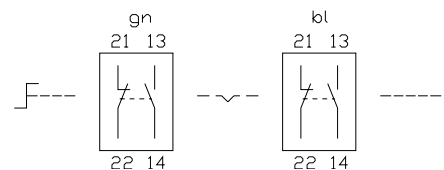

50 selector switch 3 positions 45 mm, selector switch 3 positions for flush mounting 51 - 54 mm
page 606, 620

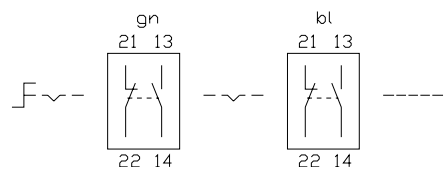

51 selector switch 3 positions 45 mm, selector switch 3 positions for flush mounting 51 - 54 mm
page 606, 620

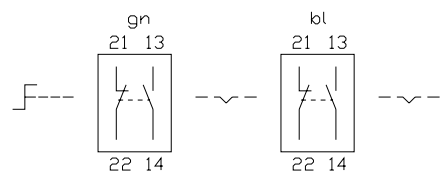

52 buzzer 30 - 55 mm, buzzer for flush mounting 39 - 64 mm
page 607, 621

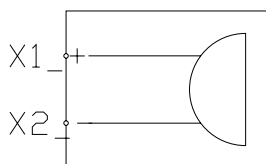

53 push-pull illuminated switch 45 mm

page 607

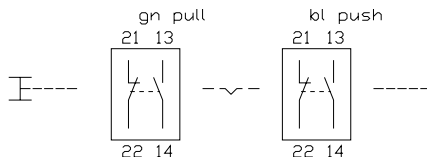

54 illuminated-/pushbutton actuator 41-44 mm for flush mounting

page 610

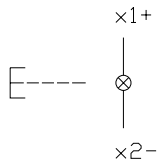

55 illuminated-/pushbutton actuator 41-44 mm for flush mounting

page 610

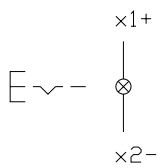

56 snap-action switching element block for 35 mm

page 631

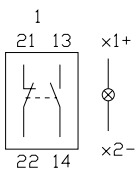

57 snap-action switching element block for 35 mm

page 631

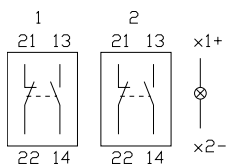

58 snap-action switching element block for 35 mm

page 631

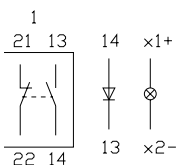

59 snap-action switching element block for 35 mm

page 631

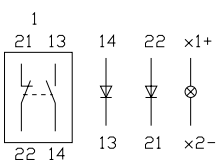

60 lamp element block for 35 mm

page 632

14 x1+

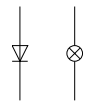

13 x2-

61 lamp element block for 35 mm

page 632

14 22 x1+

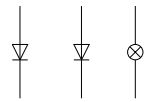

13 21 x2-

1. Engraving

The lens top or the lens holder can be engraved in any of the usual languages.
Typefaces: compressed typeface to DIN 1451. Other faces on request.

Colour of lettering

White for lens tops red, blue, green and black
Black for lens tops orange, yellow, grey and white
Black for lens holders translucent and transparent

Important!

With engraving, the position of the lens must agree with the position of the push-button or indicator.
However, the lens can be mounted turned through 180°.

2. Hot stamping

For lettering any sizeable quantity we recommend pad printing on the lens holder.

Important!

With pad printing, the position of the lens must agree with the position of the push-button or indicator.
However, the lens can be mounted turned through 180°.

3. Film insert

Instead of engraving, a transparent foil can be laid in the lens tops, except with the colours grey and black.

Foil thickness

0.1 mm max

Ø 18 mm
18 x 18 mm
18 x 24 mm
Ø 24 mm
24 x 24 mm

Ø 12,7 mm
12,7 x 12,7 mm
12,7 x 18,9 mm
Ø 18,3 mm
18,3 x 18,3 mm

Filmdickemax. 0,1mm

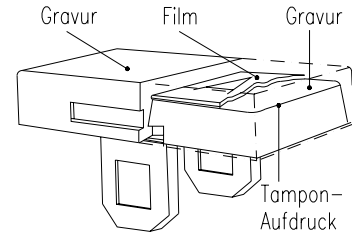

Important!

When a foil is used, the position of the lens must agree with the position of the push-button or indicator.
However, the lens can be mounted turned through 180°.

| Height of letters | 'round' 18 | | 18 x 18 | | 18 x 24 | | 24 x 18 | | 'round' 24 | | 24 x 24 | |
|-------------------|-----------------|------------------------------|-----------------|------------------------------|-----------------|------------------------------|-----------------|------------------------------|-----------------|------------------------------|-----------------|------------------------------|
| | Number of lines | - Number of letters per line | Number of lines | - Number of letters per line | Number of lines | - Number of letters per line | Number of lines | - Number of letters per line | Number of lines | - Number of letters per line | Number of lines | - Number of letters per line |
| h | | | | | | | | | | | | |
| 2,5 mm | 2 | 5 | 3 | 5 | 3 | 8 | 5 | 5 | 4 | 7 | 5 | 8 |
| 3 mm | 2 | 5 | 3 | 5 | 3 | 8 | 4 | 5 | 3 | 7 | 4 | 8 |
| 4 mm | 1 | 3 | 2 | 3 | 2 | 5 | 3 | 3 | 3 | 4 | 3 | 6 |
| 5 mm | 1 | 2 | 1 | 3 | 1 | 5 | 2 | 3 | 2 | 3 | 2 | 5 |

Компания «Life Electronics» занимается поставками электронных компонентов импортного и отечественного производства от производителей и со складов крупных дистрибьюторов Европы, Америки и Азии.

С конца 2013 года компания активно расширяет линейку поставок компонентов по направлению коаксиальный кабель, кварцевые генераторы и конденсаторы (керамические, пленочные, электролитические), за счёт заключения дистрибьюторских договоров

Мы предлагаем:

- Конкурентоспособные цены и скидки постоянным клиентам.
- Специальные условия для постоянных клиентов.
- Подбор аналогов.
- Поставку компонентов в любых объемах, удовлетворяющих вашим потребностям.
- Приемлемые сроки поставки, возможна ускоренная поставка.
- Доставку товара в любую точку России и стран СНГ.
- Комплексную поставку.
- Работу по проектам и поставку образцов.
- Формирование склада под заказчика.
- Сертификаты соответствия на поставляемую продукцию (по желанию клиента).
- Тестирование поставляемой продукции.
- Поставку компонентов, требующих военную и космическую приемку.
- Входной контроль качества.
- Наличие сертификата ISO.

В составе нашей компании организован Конструкторский отдел, призванный помогать разработчикам, и инженерам.

Конструкторский отдел помогает осуществить:

- Регистрацию проекта у производителя компонентов.
- Техническую поддержку проекта.
- Защиту от снятия компонента с производства.
- Оценку стоимости проекта по компонентам.
- Изготовление тестовой платы монтаж и пусконаладочные работы.



Тел: +7 (812) 336 43 04 (многоканальный)

Email: org@lifeelectronics.ru