

MicroTLynx™ 12A: Non-Isolated DC-DC Power Modules

2.4Vdc – 5.5Vdc input; 0.6Vdc to 3.63Vdc output; 12A Output Current

TUNABLE LOOP™
A LINEAGE POWER TRADEMARK

DOSA
Distributed power
Open Standards Alliance



RoHS Compliant EZ-SEQUENCE™

Features

- Compliant to RoHS EU Directive 2002/95/EC (Z versions)
- Compatible in a Pb-free or SnPb reflow environment (Z versions)
- Wide Input voltage range (2.4Vdc-5.5Vdc)
- Output voltage programmable from 0.6Vdc to 3.63 Vdc via external resistor
- Tunable Loop™ to optimize dynamic output voltage response
- Flexible output voltage sequencing EZ-SEQUENCE – APTH versions
- Remote sense
- Fixed switching frequency
- Output overcurrent protection (non-latching)
- Overtemperature protection
- Remote On/Off
- Ability to sink and source current
- Cost efficient open frame design
- Small size: 20.3 mm x 11.4 mm x 8.5 mm
(0.8 in x 0.45 in x 0.334 in)
- Wide operating temperature range (-40°C to 85°C)
- UL* 60950-1 Recognized, CSA† C22.2 No. 60950-1-03 Certified, and VDE‡ 0805:2001-12 (EN60950-1) Licensed
- ISO** 9001 and ISO 14001 certified manufacturing facilities

Applications

- Distributed power architectures
- Intermediate bus voltage applications
- Telecommunications equipment
- Servers and storage applications
- Networking equipment
- Industrial equipment

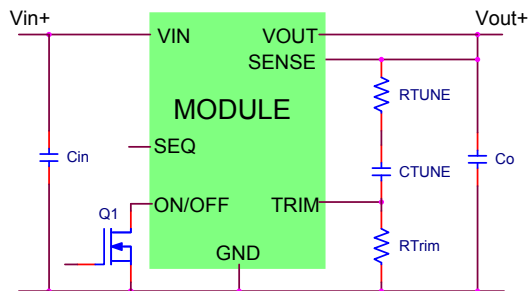

Description

The Micro TLynx™ series of power modules are non-isolated dc-dc converters that can deliver up to 12A of output current. These modules operate over a wide range of input voltage ($V_{IN} = 2.4\text{Vdc} - 5.5\text{Vdc}$) and provide a precisely regulated output voltage from 0.6Vdc to 3.63Vdc, programmable via an external resistor. Features include remote On/Off, adjustable output voltage, over current and overtemperature protection, and output voltage sequencing (APTH versions). A new feature, the Tunable Loop™, allows the user to optimize the dynamic response of the converter to match the load with reduced amount of output capacitance leading to savings on cost and PWB area.

* UL is a registered trademark of Underwriters Laboratories, Inc.

† CSA is a registered trademark of Canadian Standards Association.

‡ VDE is a trademark of Verband Deutscher Elektrotechniker e.V.

** ISO is a registered trademark of the International Organization of Standards

MicroTLynx™ 12A: Non-Isolated DC-DC Power Modules

2.4Vdc –5.5Vdc input; 0.6Vdc to 3.63Vdc output; 12A Output Current

Absolute Maximum Ratings

Stresses in excess of the absolute maximum ratings can cause permanent damage to the device. These are absolute stress ratings only, functional operation of the device is not implied at these or any other conditions in excess of those given in the operations sections of the data sheet. Exposure to absolute maximum ratings for extended periods can adversely affect the device reliability.

Parameter	Device	Symbol	Min	Max	Unit
Input Voltage Continuous	All	V_{IN}	-0.3	6	Vdc
Sequencing Voltage	APTH	V_{SEQ}	-0.3	$V_{IN,Max}$	Vdc
Operating Ambient Temperature (see Thermal Considerations section)	All	T_A	-40	85	°C
Storage Temperature	All	T_{stg}	-55	125	°C

Electrical Specifications

Unless otherwise indicated, specifications apply over all operating input voltage, resistive load, and temperature conditions.

Parameter	Device	Symbol	Min	Typ	Max	Unit
Operating Input Voltage	All	V_{IN}	2.4	—	5.5	Vdc
Maximum Input Current ($V_{IN}=2.4V$ to $5.5V$, $I_O=I_{O,max}$)	All	$I_{IN,max}$			11A	A dc
Input No Load Current ($V_{IN} = 5.0Vdc$, $I_O = 0$, module enabled)	$V_{O,set} = 0.6 Vdc$	$I_{IN,No load}$		36		mA
	$V_{O,set} = 3.3Vdc$	$I_{IN,No load}$		81		mA
Input Stand-by Current ($V_{IN} = 5.0Vdc$, module disabled)	All	$I_{IN,stand-by}$		3		mA
Inrush Transient	All	I^2t			1	A ² s
Input Reflected Ripple Current, peak-to-peak (5Hz to 20MHz, 1 μ H source impedance; $V_{IN} = 0$ to 5.5V, $I_O = I_{O,max}$; See Test Configurations)	All			49		mAp-p
Input Ripple Rejection (120Hz)	All			-30		dB

MicroTlynx™ 12A: Non-Isolated DC-DC Power Modules

2.4Vdc –5.5Vdc input; 0.6Vdc to 3.63Vdc output; 12A Output Current

Electrical Specifications (continued)

Parameter	Device	Symbol	Min	Typ	Max	Unit
Output Voltage Set-point	All	$V_{O, set}$	-1.5		+1.5	% $V_{O, set}$
Output Voltage (Over all operating input voltage, resistive load, and temperature conditions until end of life)	All	$V_{O, set}$	-3.0	—	+3.0	% $V_{O, set}$
Adjustment Range Selected by an external resistor	All	V_O	0.6		3.63	Vdc
Output Regulation (for $V_O \geq 2.5$ Vdc)						
Line ($V_{IN}=V_{IN, min}$ to $V_{IN, max}$)	All			—	0.4	% $V_{O, set}$
Load ($I_O=I_{O, min}$ to $I_{O, max}$)	All			—	10	mV
Output Regulation (for $V_O < 2.5$ Vdc)						
Line ($V_{IN}=V_{IN, min}$ to $V_{IN, max}$)	All			—	10	mV
Load ($I_O=I_{O, min}$ to $I_{O, max}$)	All			—	5	mV
Temperature ($T_{ref}=T_{A, min}$ to $T_{A, max}$)	All			—	0.4	% $V_{O, set}$
Remote Sense Range	All				0.5	V
Output Ripple and Noise on nominal output ($V_{IN}=V_{IN, nom}$ and $I_O=I_{O, min}$ to $I_{O, max}$ $C_O = 0.1\mu F // 10\mu F$ ceramic capacitors)						
Peak-to-Peak (5Hz to 20MHz bandwidth)	All		—	25	35	mV _{pk-pk}
RMS (5Hz to 20MHz bandwidth)	All		—	10	15	mV _{rms}
External Capacitance ¹ Without the Tunable Loop™ ESR ≥ 1 m Ω	All	$C_{O, max}$	0	—	200	μF
With the Tunable Loop™ ESR ≥ 0.15 m Ω	All	$C_{O, max}$	0	—	1000	μF
ESR ≥ 10 m Ω	All	$C_{O, max}$	0	—	5000	μF
Output Current	All	I_O	0		12	A _{dc}
Output Current Limit Inception (Hiccup Mode)	All	$I_{O, lim}$			200	% $I_{O, max}$
Output Short-Circuit Current ($V_O \leq 250$ mV) (Hiccup Mode)	All	$I_{O, s/c}$		30		% $I_{O, max}$
Efficiency $V_{IN} = 3.3$ Vdc, $T_A = 25^\circ C$ $I_O = I_{O, max}$, $V_O = V_{O, set}$	$V_{O, set} = 0.6$ Vdc	η		75.0		%
	$V_{O, set} = 1.2$ Vdc	η		85.5		%
	$V_{O, set} = 1.8$ Vdc	η		89.9		%
	$V_{O, set} = 2.5$ Vdc	η		92.7		%
$V_{in} = 5$ Vdc	$V_{O, set} = 3.3$ Vdc	η		94.6		%
Switching Frequency	All	f_{sw}	—	600	—	kHZ

¹ External capacitors may require using the new Tunable Loop™ feature to ensure that the module is stable as well as getting the best transient response. See the Tunable Loop™ section for details.

MicroTLynx™ 12A: Non-Isolated DC-DC Power Modules

2.4Vdc –5.5Vdc input; 0.6Vdc to 3.63Vdc output; 12A Output Current

General Specifications

Parameter	Min	Typ	Max	Unit
Calculated MTBF (I _o =I _{o,max} , T _A =25°C) Telecordia Issue 2, Method 1 Case 3		28,160,677		Hours
Weight	—	3.59 (0.127)	—	g (oz.)

Feature Specifications

Unless otherwise indicated, specifications apply over all operating input voltage, resistive load, and temperature conditions. See Feature Descriptions for additional information.

Parameter	Device	Symbol	Min	Typ	Max	Unit
On/Off Signal Interface (V _{IN} =V _{IN,min} to V _{IN,max} ; open collector or equivalent, Signal referenced to GND) Device is with suffix "4" – Positive Logic (See Ordering Information) Logic High (Module ON) Input High Current Input High Voltage Logic Low (Module OFF) Input Low Current Input Low Voltage	All All All All	I _{IH} V _{IH} I _{IL} V _{IL}	— V _{IN} – 0.8 — -0.2	— — — —	10 V _{IN,max} 0.3 0.3	μA V mA V
Device Code with no suffix – Negative Logic (See Ordering Information) (On/OFF pin is open collector/drain logic input with external pull-up resistor; signal referenced to GND) Logic High (Module OFF) Input High Current Input High Voltage Logic Low (Module ON) Input low Current Input Low Voltage	All All All All	I _{IH} V _{IH} I _{IL} V _{IL}	— V _{IN} – 1.6 — -0.2	— — — —	2 V _{IN,max} 1 V _{IN} – 1.6	mA Vdc mA Vdc
Turn-On Delay and Rise Times						
(V _{IN} =V _{IN,nom} , I _o =I _{o,max} , V _o to within ±1% of steady state) Case 1: On/Off input is enabled and then input power is applied (delay from instant at which V _{IN} = V _{IN,min} until V _o = 10% of V _{o,set}) Case 2: Input power is applied for at least one second and then the On/Off input is enabled (delay from instant at which V _{on/Off} is enabled until V _o = 10% of V _{o,set}) Output voltage Rise time (time for V _o to rise from 10% of V _{o,set} to 90% of V _{o,set})	All All All	T _{delay} T _{delay} T _{rise}	— — —	2 2 5	— — —	msec msec msec
Output voltage overshoot (T _A = 25°C V _{IN} = V _{IN,min} to V _{IN,max} ; I _o = I _{o,min} to I _{o,max}) With or without maximum external capacitance					3.0	% V _{o,set}
Over Temperature Protection (See Thermal Considerations section)	All	T _{ref}		130		°C
Sequencing Delay time Delay from V _{IN,min} to application of voltage on SEQ pin	APTH	T _{SEQ-delay}	10			msec
Tracking Accuracy (Power-Up: 2V/ms)	APTHI	V _{SEQ} – V _o			100	mV
(Power-Down: 2V/ms)	APTH	V _{SEQ} – V _o			100	mV
(V _{IN,min} to V _{IN,max} ; I _{o,min} to I _{o,max} V _{SEQ} < V _o)						

MicroTLynx™ 12A: Non-Isolated DC-DC Power Modules
 2.4Vdc –5.5Vdc input; 0.6Vdc to 3.63Vdc output; 12A Output Current

Feature Specifications (continued)

Parameter	Device	Symbol	Min	Typ	Max	Units
Input Undervoltage Lockout						
Turn-on Threshold	All				2.2	Vdc
Turn-off Threshold	All		1.75			Vdc
Hysteresis	All		0.08		0.2	Vdc

MicroTlynx™ 12A: Non-Isolated DC-DC Power Modules

2.4Vdc –5.5Vdc input; 0.6Vdc to 3.6Vdc output; 12A Output Current

Characteristic Curves

The following figures provide typical characteristics for the Micro Tlynx™ at 0.6Vo and at 25°C.

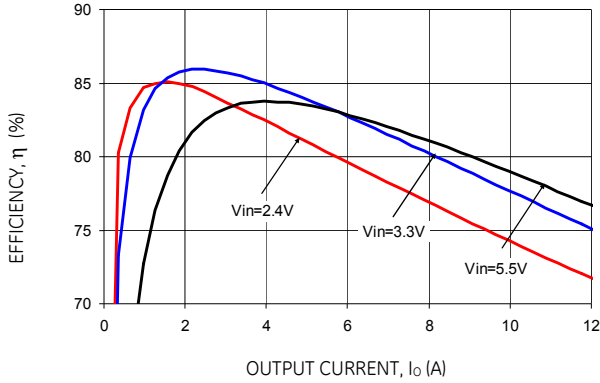

Figure 1. Converter Efficiency versus Output Current.

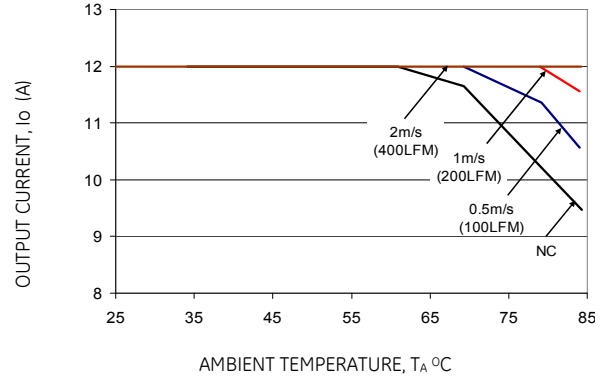

Figure 2. Derating Output Current versus Ambient Temperature and Airflow.

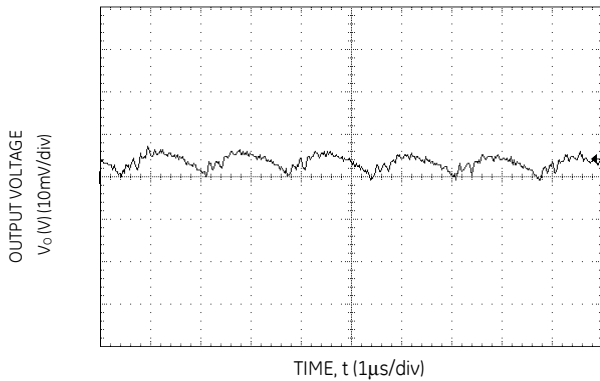

Figure 3. Typical output ripple and noise ($V_{IN} = 5V$, $I_o = I_{o,max}$).

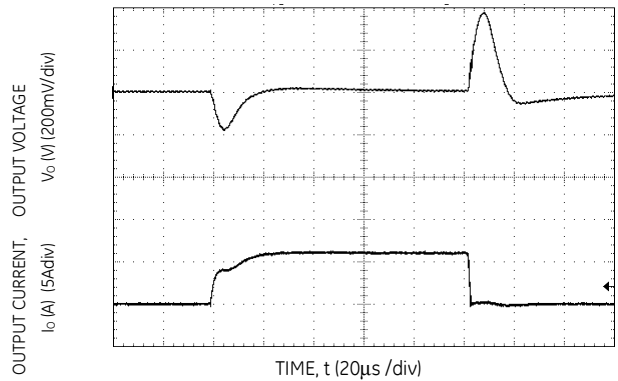

Figure 4. Transient Response to Dynamic Load Change from 0% to 50% to 0% with $V_{IN}=5V$.

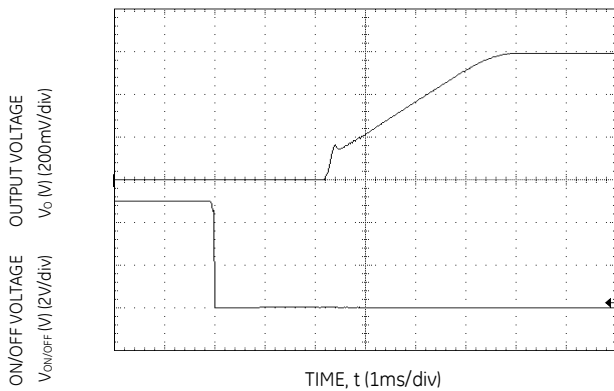

Figure 5. Typical Start-up Using On/Off Voltage ($I_o = I_{o,max}$).

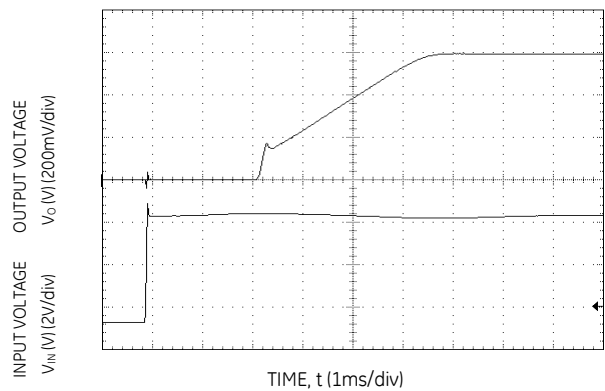

Figure 6. Typical Start-up Using Input Voltage ($V_{IN} = 5V$, $I_o = I_{o,max}$).

MicroTlynx™ 12A: Non-Isolated DC-DC Power Modules

2.4Vdc –5.5Vdc input; 0.6Vdc to 3.63Vdc output; 12A Output Current

Characteristic Curves (continued)

The following figures provide typical characteristics for the Micro Tlynx™ at 1.2Vo and at 25°C.

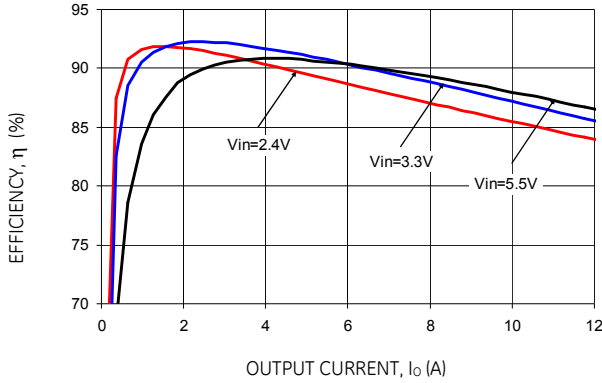

Figure 7. Converter Efficiency versus Output Current.

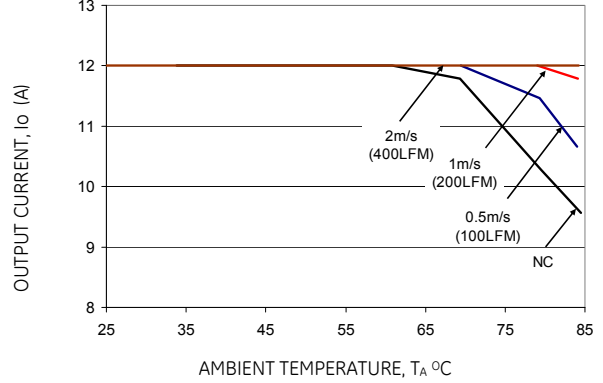

Figure 8. Derating Output Current versus Ambient Temperature and Airflow.

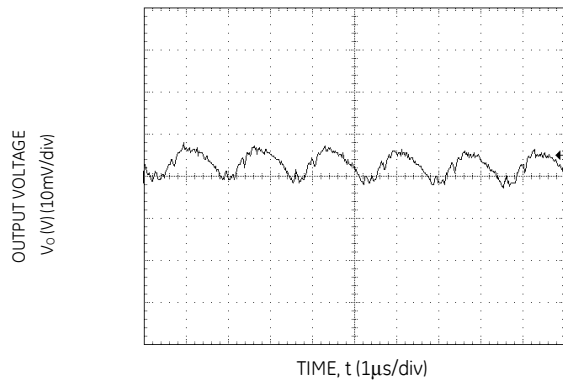

Figure 9. Typical output ripple and noise (VIN = 5V, Io = Io,max).

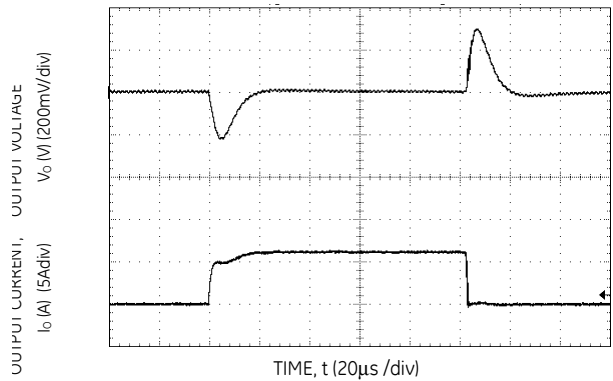

Figure 10. Transient Response to Dynamic Load Change from 0% to 50% to 0% with VIN=5V.

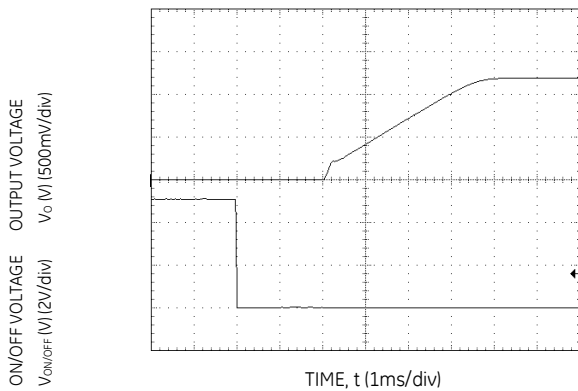

Figure 11. Typical Start-up Using On/Off Voltage (Io = Io,max).

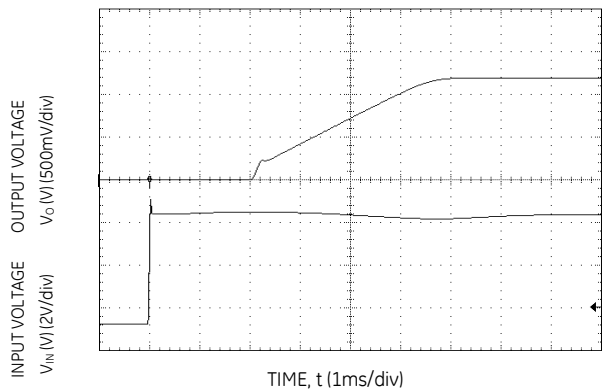

Figure 12. Typical Start-up Using Input Voltage (VIN = 5V, Io = Io,max).

MicroTLynx™ 12A: Non-Isolated DC-DC Power Modules

2.4Vdc –5.5Vdc input; 0.6Vdc to 3.63Vdc output; 12A Output Current

Characteristic Curves (continued)

The following figures provide typical characteristics for the Micro TLynx™ at 1.8Vo and at 25°C.

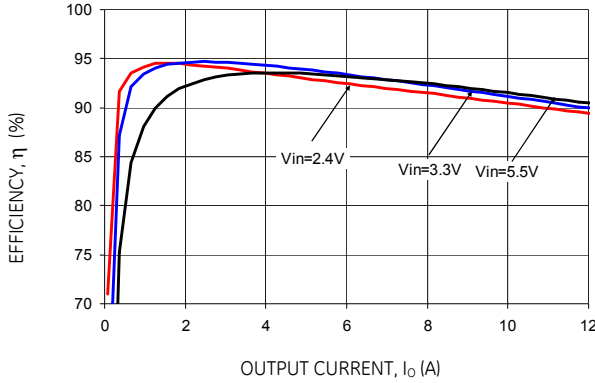

Figure 13. Converter Efficiency versus Output Current.

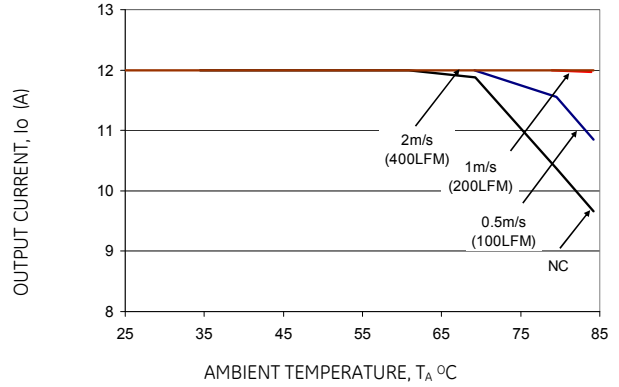

Figure 14. Derating Output Current versus Ambient Temperature and Airflow.

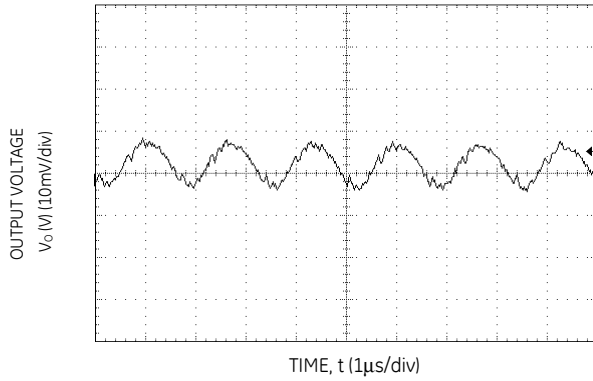

Figure 15. Typical output ripple and noise ($V_{IN} = 5V, I_o = I_{o,max}$).

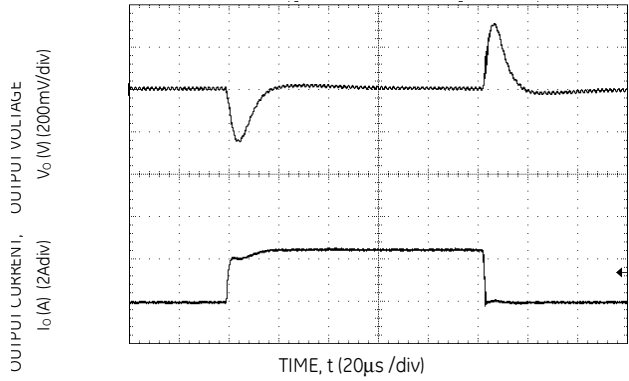

Figure 16. Transient Response to Dynamic Load Change from 0% to 50% to 0% with $V_{IN}=5V$.

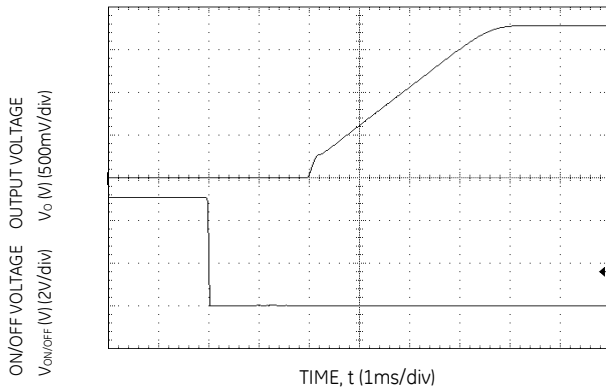

Figure 17. Typical Start-up Using On/Off Voltage ($I_o = I_{o,max}$).

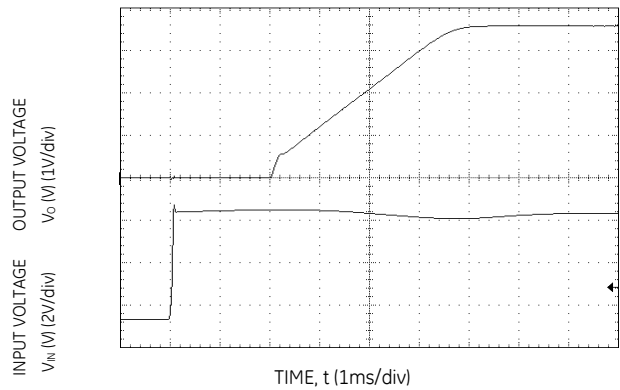

Figure 18. Typical Start-up Using Input Voltage ($V_{IN} = 5V, I_o = I_{o,max}$).

MicroTlynx™ 12A: Non-Isolated DC-DC Power Modules

2.4Vdc –5.5Vdc input; 0.6Vdc to 3.63Vdc output; 12A Output Current

Characteristic Curves (continued)

The following figures provide typical characteristics for the Micro Tlynx™ at 2.5Vo and at 25°C.

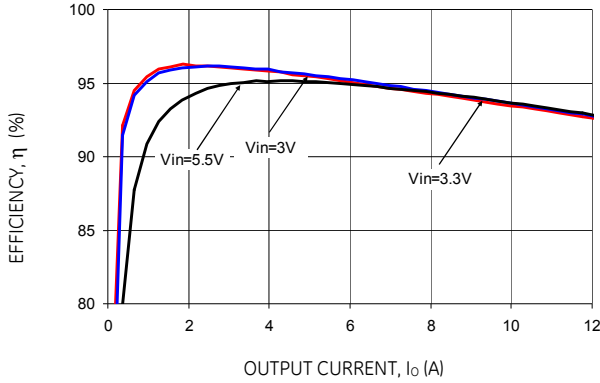

Figure 19. Converter Efficiency versus Output Current.

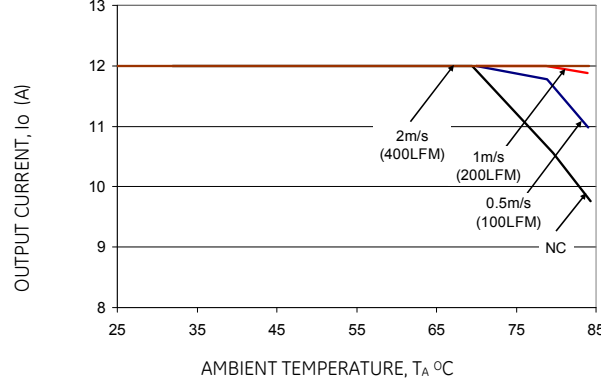

Figure 20. Derating Output Current versus Ambient Temperature and Airflow.

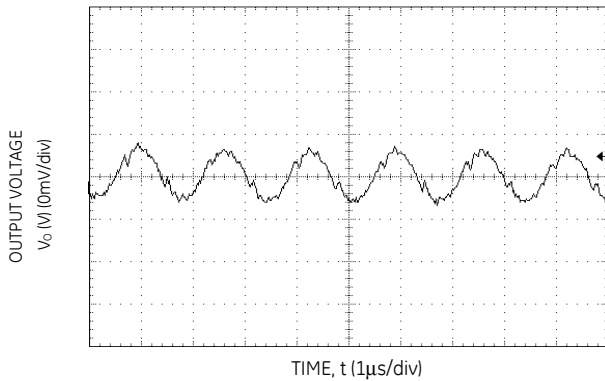

Figure 21. Typical output ripple and noise ($V_{IN} = 5V$, $I_o = I_{o,max}$).

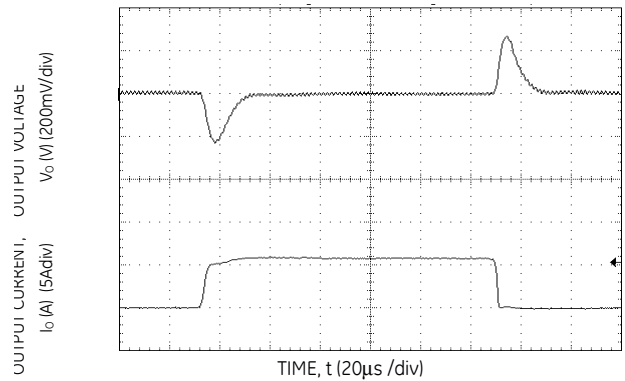

Figure 22. Transient Response to Dynamic Load Change from 0% to 50% to 0% with $V_{IN}=5V$.

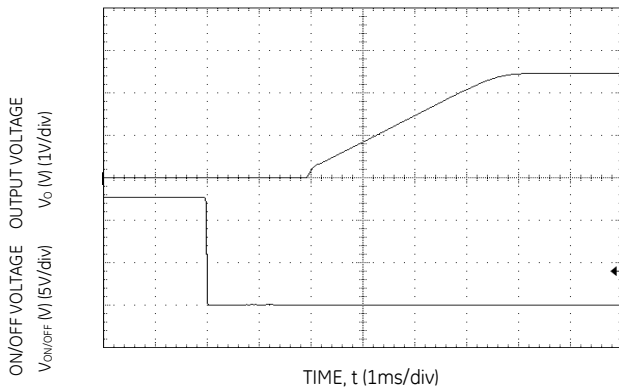

Figure 23. Typical Start-up Using On/Off Voltage ($I_o = I_{o,max}$).

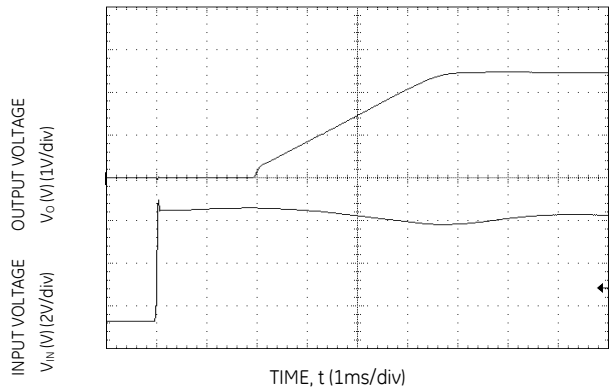

Figure 24. Typical Start-up Using Input Voltage ($V_{IN} = 5V$, $I_o = I_{o,max}$).

MicroTlynx™ 12A: Non-Isolated DC-DC Power Modules

2.4Vdc –5.5Vdc input; 0.6Vdc to 3.63Vdc output; 12A Output Current

Characteristic Curves (continued)

The following figures provide typical characteristics for the Micro Tlynx™ at 3.3V_o and at 25°C.

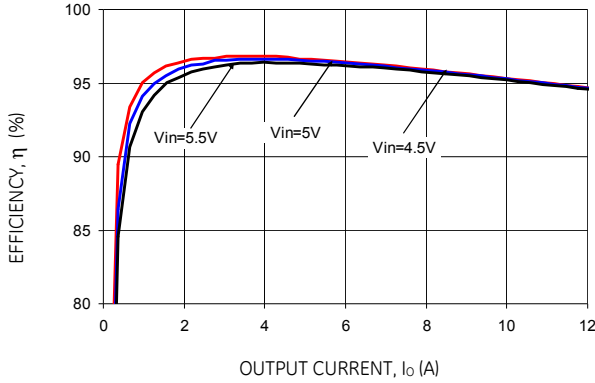

Figure 25. Converter Efficiency versus Output Current.

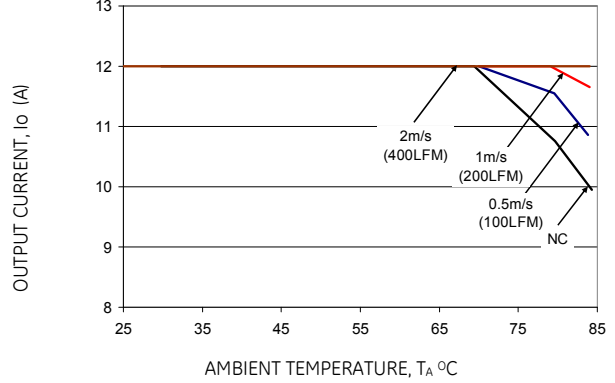

Figure 26. Derating Output Current versus Ambient Temperature and Airflow.

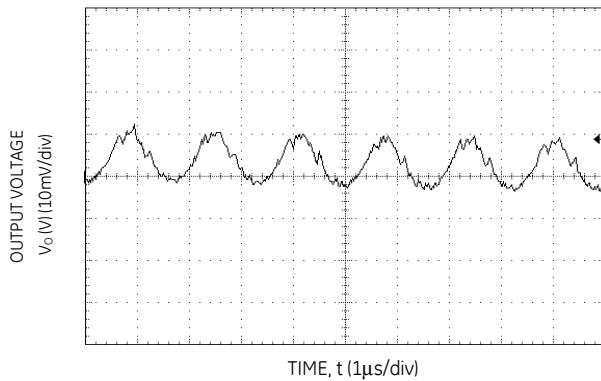

Figure 27. Typical output ripple and noise ($V_{IN} = 5V$, $I_o = I_{o,max}$).

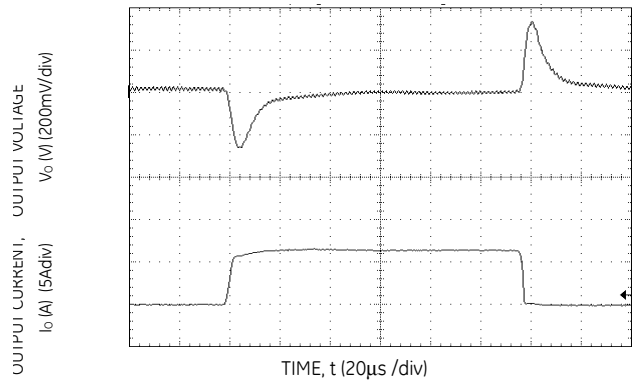

Figure 28. Transient Response to Dynamic Load Change from 0% 50% to 0% with $V_{IN}=5V$.

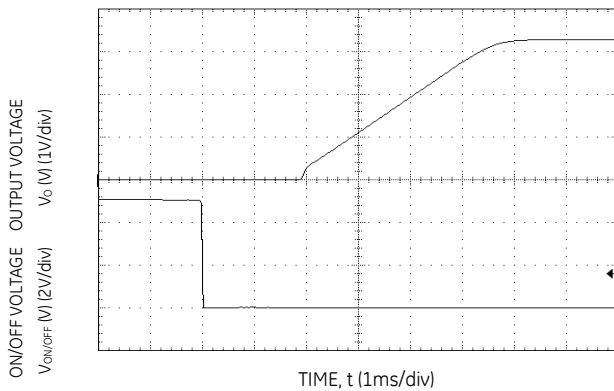

Figure 29. Typical Start-up Using On/Off Voltage ($I_o = I_{o,max}$).

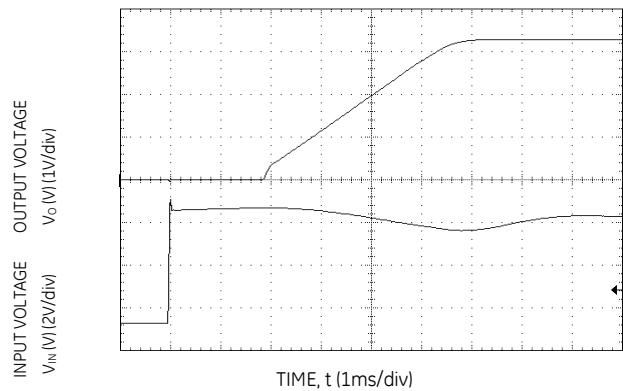
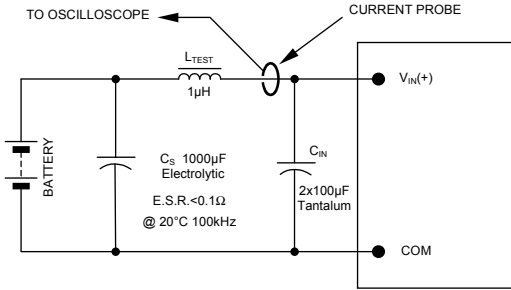

Figure 30. Typical Start-up Using Input Voltage ($V_{IN} = 5V$, $I_o = I_{o,max}$).

MicroTLynx™ 12A: Non-Isolated DC-DC Power Modules

2.4Vdc –5.5Vdc input; 0.6Vdc to 3.63Vdc output; 12A Output Current

Test Configurations



NOTE: Measure input reflected ripple current with a simulated source inductance (L_{TEST}) of 1µH. Capacitor C_S offsets possible battery impedance. Measure current as shown above.

Figure 31. Input Reflected Ripple Current Test Setup.

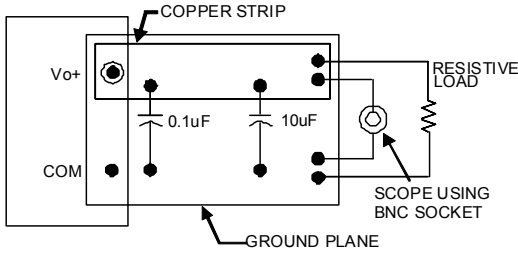

NOTE: All voltage measurements to be taken at the module terminals, as shown above. If sockets are used then Kelvin connections are required at the module terminals to avoid measurement errors due to socket contact resistance.

Figure 32. Output Ripple and Noise Test Setup.

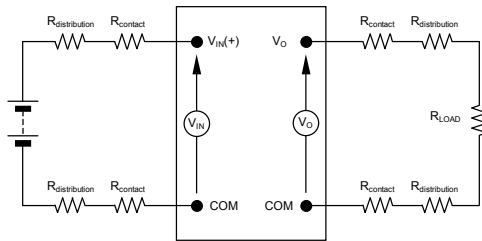

NOTE: All voltage measurements to be taken at the module terminals, as shown above. If sockets are used then Kelvin connections are required at the module terminals to avoid measurement errors due to socket contact resistance.

Figure 33. Output Voltage and Efficiency Test Setup.

$$\text{Efficiency } \eta = \frac{V_O \cdot I_O}{V_{IN} \cdot I_{IN}} \times 100 \%$$

Design Considerations

Input Filtering

The Micro TLynx™ module should be connected to a low ac-impedance source. A highly inductive source can affect the stability of the module. An input capacitance must be placed directly adjacent to the input pin of the module, to minimize input ripple voltage and ensure module stability.

To minimize input voltage ripple, low-ESR ceramic capacitors are recommended at the input of the module. Figure 34 shows the input ripple voltage for various output voltages at 3A of load current with 1x47 µF or 2x47 µF ceramic capacitors and an input of 5V. Figure 35 shows data for the 3.3Vin case, with 1x47µF or 2x37µF of ceramic capacitors at the input.

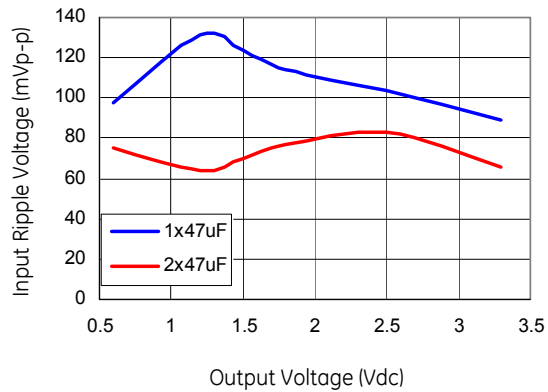

Figure 34. Input ripple voltage for various output voltages with 1x47 µF or 2x47 µF ceramic capacitors at the input (12A load). Input voltage is 5V.

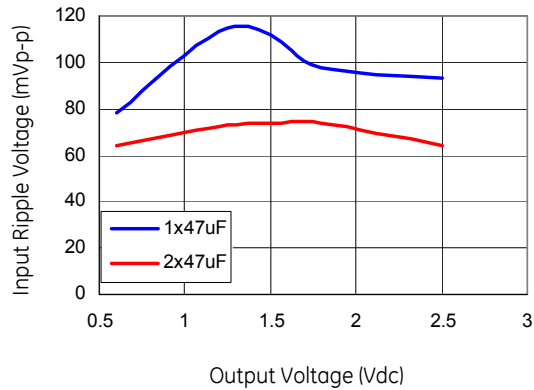

Figure 35. Input ripple voltage in mV, p-p for various output voltages with 1x47 µF or 2x47 µF ceramic capacitors at the input (12A load). Input voltage is 3.3V.

MicroTlynx™ 12A: Non-Isolated DC-DC Power Modules

2.4Vdc –5.5Vdc input; 0.6Vdc to 3.63Vdc output; 12A Output Current

Output Filtering

The Micro Tlynx™ modules are designed for low output ripple voltage and will meet the maximum output ripple specification with 0.1 μF ceramic and 10 μF ceramic capacitors at the output of the module. However, additional output filtering may be required by the system designer for a number of reasons. First, there may be a need to further reduce the output ripple and noise of the module. Second, the dynamic response characteristics may need to be customized to a particular load step change.

To reduce the output ripple and improve the dynamic response to a step load change, additional capacitance at the output can be used. Low ESR ceramic and polymer capacitors are recommended to improve the dynamic response of the module. Figure 36 provides output ripple information for different external capacitance values at various Vo and for load currents of 12A while maintaining an input voltage of 5V. Fig 37 shows the performance with a 3.3V input. For stable operation of the module, limit the capacitance to less than the maximum output capacitance as specified in the electrical specification table. Optimal performance of the module can be achieved by using the Tunable Loop™ feature described later in this data sheet.

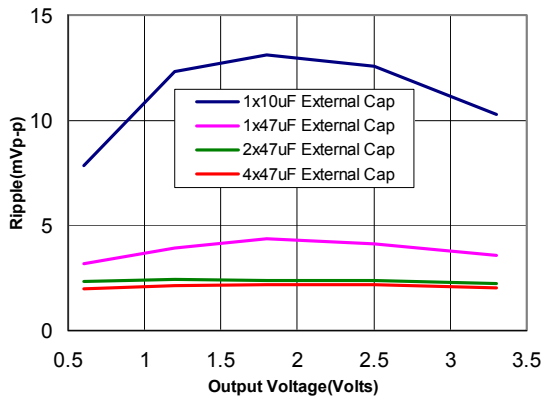

Figure 36. Output ripple voltage for various output voltages with external 1x10 μF, 1x47 μF, 2x47 μF or 4x47 μF ceramic capacitors at the output (12A load). Input voltage is 5V.

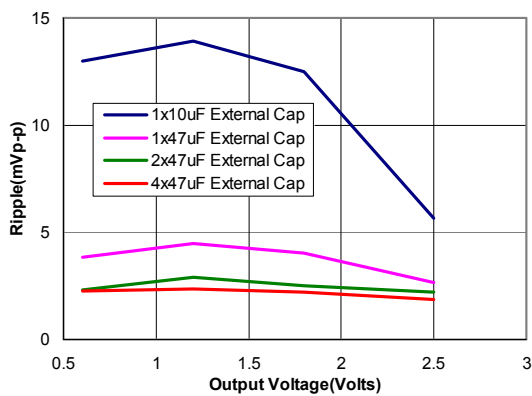

Figure 37. Output ripple voltage for various output voltages with external 1x10 μF, 1x47 μF, 2x47 μF or 4x47 μF ceramic capacitors at the output (12A load). Input voltage is 3.3V.

Safety Considerations

For safety agency approval the power module must be installed in compliance with the spacing and separation requirements of the end-use safety agency standards, i.e., UL 60950-1, CSA C22.2 No. 60950-1-03, and VDE 0850:2001-12 (EN60950-1) Licensed.

For the converter output to be considered meeting the requirements of safety extra-low voltage (SELV), the input must meet SELV requirements. The power module has extra-low voltage (ELV) outputs when all inputs are ELV.

Feature Descriptions

Remote On/Off

The Micro Tlynx™ modules feature an On/Off pin for remote On/Off operation. Two On/Off logic options are available. In the Positive Logic On/Off option, (device code suffix “4” – see Ordering Information), the module turns ON during a logic High on the On/Off pin and turns OFF during a logic Low. With the Negative Logic On/Off option, (no device code suffix, see Ordering Information), the module turns OFF during logic High and ON during logic Low. The On/Off signal is always referenced to ground. For either On/Off logic option, leaving the On/Off pin disconnected will turn the module ON when input voltage is present.

For positive logic modules, the circuit configuration for using the On/Off pin is shown in Figure 38. For positive logic modules, the circuit configuration for using the On/Off pin is shown in Figure 38. When the external transistor Q1 is in the OFF state, Q2 is ON, the internal PWM Enable signal is pulled low and the module is ON. When transistor Q1 is turned ON, the On/Off pin is pulled low, Q2 is turned off and the internal PWM Enable signal is pulled high through the 23.7K pull-up resistor and the module is OFF.

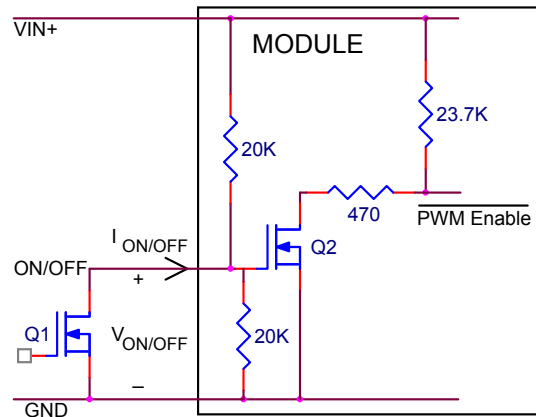

Figure 38. Circuit configuration for using positive On/Off logic.

For negative logic On/Off modules, the circuit configuration is shown in Fig. 39. The On/Off pin should be pulled high with an

MicroTLynx™ 12A: Non-Isolated DC-DC Power Modules

2.4Vdc –5.5Vdc input; 0.6Vdc to 3.63Vdc output; 12A Output Current

external pull-up resistor (suggested value for the 2.4V to 5.5V input range is 3Kohms). When transistor Q1 is in the OFF state, the On/Off pin is pulled high and the module is OFF. The On/Off threshold for logic High on the On/Off pin depends on the input voltage and its minimum value is $V_{IN} - 1.6V$. To turn the module ON, Q1 is turned ON pulling the On/Off pin low.

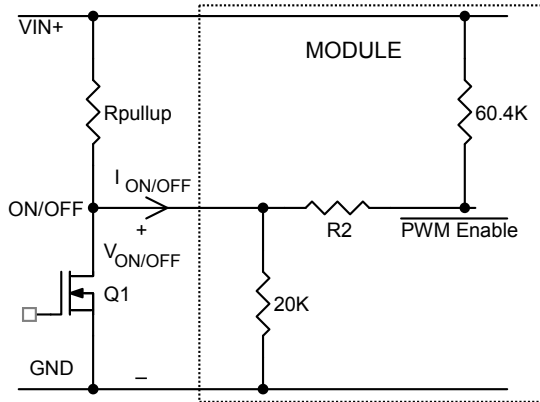

Figure 39. Circuit configuration for using negative On/Off logic.

Overcurrent Protection

To provide protection in a fault (output overload) condition, the unit is equipped with internal current-limiting circuitry and can endure current limiting continuously. At the point of current-limit inception, the unit enters hiccup mode. The unit operates normally once the output current is brought back into its specified range.

Overtemperature Protection

To provide protection in a fault condition, the unit is equipped with a thermal shutdown circuit. The unit will shutdown if the overtemperature threshold of 130°C is exceeded at the thermal reference point T_{ref} . The thermal shutdown is not intended as a guarantee that the unit will survive temperatures beyond its rating. Once the unit goes into thermal shutdown it will then wait to cool before attempting to restart.

Input Undervoltage Lockout

At input voltages below the input undervoltage lockout limit, the module operation is disabled. The module will begin to operate at an input voltage above the undervoltage lockout turn-on threshold.

Output Voltage Programming

The output voltage of the Micro TLynx™ module can be programmed to any voltage from 0.6Vdc to 3.63Vdc by connecting a resistor between the Trim+ and GND pins of the module. Certain restrictions apply on the output voltage set point depending on the input voltage. These are shown in the Output Voltage vs. Input Voltage Set Point Area plot in Fig. 40. The Upper Limit curve shows that the entire output voltage range is available with the maximum input voltage of 5.5V. The Lower Limit curve shows that for output voltages of 1.8V and

higher, the input voltage needs to be larger than the minimum of 2.4V.

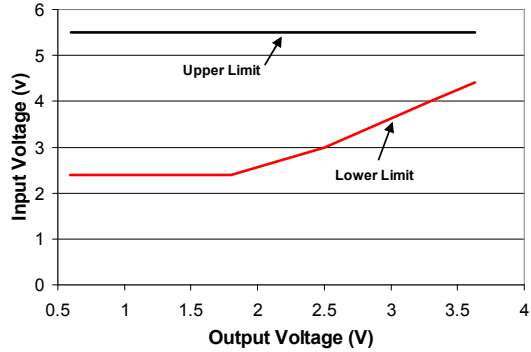

Figure 40. Output Voltage vs. Input Voltage Set Point Area plot showing limits where the output voltage can be set for different input voltages.

Without an external resistor between Trim+ and GND pins, the output of the module will be 0.6Vdc. To calculate the value of the trim resistor, R_{trim} for a desired output voltage, use the following equation:

$$R_{trim} = \left[\frac{1.2}{(V_o - 0.6)} \right] k\Omega$$

R_{trim} is the external resistor in $k\Omega$, and V_o is the desired output voltage.

Table 1 provides R_{trim} values required for some common output voltages.

Table 1

$V_{o, set}$ (V)	R_{trim} (k Ω)
0.6	Open
1.0	3.0
1.2	2.0
1.5	1.333
1.8	1.0
2.5	0.632
3.3	0.444

By using a $\pm 0.5\%$ tolerance trim resistor with a TC of $\pm 25ppm$, a set point tolerance of $\pm 1.5\%$ can be achieved as specified in the electrical specification. The POL Programming Tool available at www.lineagepower.com under the Design Tools section, helps determine the required trim resistor needed for a specific output voltage.

MicroTLynx™ 12A: Non-Isolated DC-DC Power Modules

2.4Vdc –5.5Vdc input; 0.6Vdc to 3.63Vdc output; 12A Output Current

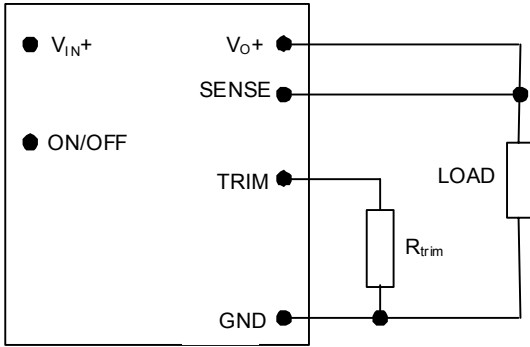

Figure 41. Circuit configuration for programming output voltage using an external resistor.

Remote Sense

The Micro TLynx™ modules have a Remote Sense feature to minimize the effects of distribution losses by regulating the voltage at the SENSE pin. The voltage between the SENSE pin and VOUT pin must not exceed 0.5V. Note that the output voltage of the module cannot exceed the specified maximum value. This includes the voltage drop between the SENSE and Vout pins. When the Remote Sense feature is not being used, connect the SENSE pin to the VOUT pin.

Voltage Margining

Output voltage margining can be implemented in the Micro TLynx™ modules by connecting a resistor, $R_{margin-up}$, from the Trim pin to the ground pin for margining-up the output voltage and by connecting a resistor, $R_{margin-down}$, from the Trim pin to output pin for margining-down. Figure 42 shows the circuit configuration for output voltage margining. The POL Programming Tool, available at www.lineagepower.com under the Design Tools section, also calculates the values of $R_{margin-up}$ and $R_{margin-down}$ for a specific output voltage and % margin. Please consult your local Lineage Power technical representative for additional details.

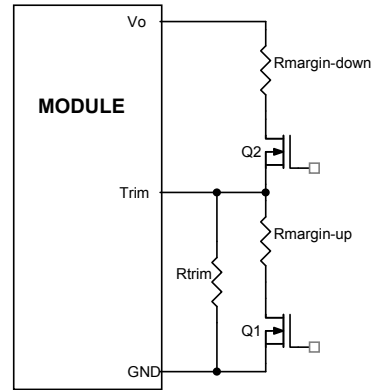

Figure 42. Circuit Configuration for margining Output voltage

Monotonic Start-up and Shutdown

The Micro TLynx™ modules have monotonic start-up and shutdown behavior for any combination of rated input voltage, output current and operating temperature range.

Startup into Pre-biased Output

The 5.5V Pico TLynx™ 12A modules can start into a prebiased output as long as the prebias voltage is 0.5V less than the set output voltage. Note that prebias operation is not supported when output voltage sequencing is used.

Output Voltage Sequencing

The APTH012A0X modules include a sequencing feature, EZ-SEQUENCE that enables users to implement various types of output voltage sequencing in their applications. This is accomplished via an additional sequencing pin. When not using the sequencing feature, either tie the SEQ pin to V_{IN} or leave it unconnected.

When an analog voltage is applied to the SEQ pin, the output voltage tracks this voltage until the output reaches the set-point voltage. The final value of the SEQ voltage must be set higher than the set-point voltage of the module. The output voltage follows the voltage on the SEQ pin on a one-to-one volt basis. By connecting multiple modules together, multiple modules can track their output voltages to the voltage applied on the SEQ pin.

MicroTLynx™ 12A: Non-Isolated DC-DC Power Modules

2.4Vdc –5.5Vdc input; 0.6Vdc to 3.63Vdc output; 12A Output Current

For proper voltage sequencing, first, input voltage is applied to the module. The On/Off pin of the module is left unconnected (or tied to GND for negative logic modules or tied to V_{IN} for positive logic modules) so that the module is ON by default. After applying input voltage to the module, a minimum 10msec delay is required before applying voltage on the SEQ pin. This delay gives the module enough time to complete its internal power-up soft-start cycle. During the delay time, the SEQ pin should be held close to ground (nominally $50\text{mV} \pm 20\text{mV}$). This is required to keep the internal op-amp out of saturation thus preventing output overshoot during the start of the sequencing ramp. By selecting resistor R1 (see fig. 43) according to the following equation

$$R1 = \frac{24950}{V_{IN} - 0.05} \text{ ohms,}$$

the voltage at the sequencing pin will be 50mV when the sequencing signal is at zero.

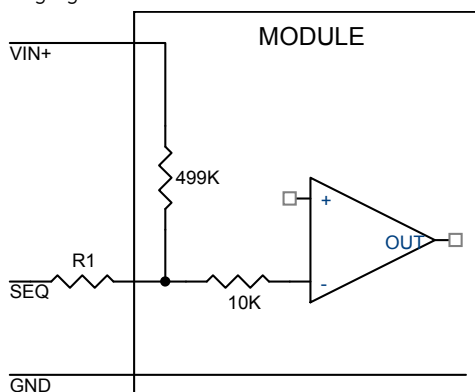

Figure 43. Circuit showing connection of the sequencing signal to the SEQ pin.

After the 10msec delay, an analog voltage is applied to the SEQ pin and the output voltage of the module will track this voltage on a one-to-one volt bases until the output reaches the set-point voltage. To initiate simultaneous shutdown of the modules, the SEQ pin voltage is lowered in a controlled manner. The output voltage of the modules tracks the voltages below their set-point voltages on a one-to-one basis. A valid input voltage must be maintained until the tracking and output voltages reach ground potential.

When using the EZ-SEQUENCE™ feature to control start-up of the module, pre-bias immunity during start-up is disabled. The pre-bias immunity feature of the module relies on the module being in the diode-mode during start-up. When using the EZ-SEQUENCE™ feature, modules goes through an internal set-up time of 10msec, and will be in synchronous rectification mode when the voltage at the SEQ pin is applied. This will result in the module sinking current if a pre-bias voltage is present at the output of the module. When pre-bias immunity during start-up is required, the EZ-SEQUENCE™ feature must be disabled. For additional guidelines on using the EZ-SEQUENCE™ feature please refer to Application Note AN04-008 "Application Guidelines for Non-Isolated Converters:

Guidelines for Sequencing of Multiple Modules", or contact the Lineage Power technical representative for additional information.

MicroTLynx™ 12A: Non-Isolated DC-DC Power Modules

2.4Vdc –5.5Vdc input; 0.6Vdc to 3.63Vdc output; 12A Output Current

Tunable Loop™

The 5V Pico TLynx™ 12A modules have a new feature that optimizes transient response of the module called Tunable Loop™.

External capacitors are usually added to the output of the module for two reasons: to reduce output ripple and noise (see Figures 36 and 37) and to reduce output voltage deviations from the steady-state value in the presence of dynamic load current changes. Adding external capacitance however affects the voltage control loop of the module, typically causing the loop to slow down with sluggish response. Larger values of external capacitance could also cause the module to become unstable.

The Tunable Loop™ allows the user to externally adjust the voltage control loop to match the filter network connected to the output of the module. The Tunable Loop™ is implemented by connecting a series R-C between the SENSE and TRIM pins of the module, as shown in Fig. 44. This R-C allows the user to externally adjust the voltage loop feedback compensation of the module.

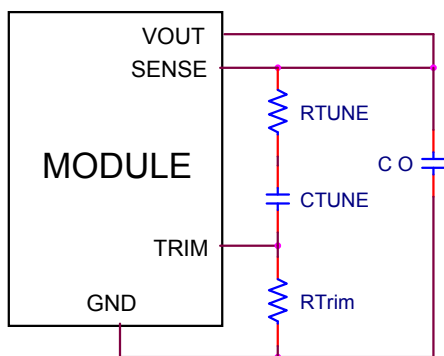

Figure 44. Circuit diagram showing connection of R_{TUNE} and C_{TUNE} to tune the control loop of the module.

Recommended values of R_{TUNE} and C_{TUNE} for different output capacitor combinations are given in Tables 2, 3, 4 and 5. Tables 2 and 4 show the recommended values of R_{TUNE} and C_{TUNE} for different values of ceramic output capacitors up to 940µF that might be needed for an application to meet output ripple and noise requirements for 5V_{in} and 3.3V_{in} respectively. Selecting R_{TUNE} and C_{TUNE} according to Table 2 will ensure stable operation of the module.

In applications with tight output voltage limits in the presence of dynamic current loading, additional output capacitance will be required. Tables 3 and 5 list recommended values of R_{TUNE} and C_{TUNE} in order to meet 2% output voltage deviation limits for some common output voltages in the presence of a 1.5A to 3A step change (50% of full load), with an input voltage of 5V_{in} and 3.3V_{in} respectively

Please contact your Lineage Power technical representative to obtain more details of this feature as well as for guidelines on how to select the right value of external R-C to tune the module for best transient performance and stable operation for other output capacitance values or input voltages other than 5 or 3.3V.

Table 2. General recommended values of R_{TUNE} and C_{TUNE} for $V_{in}=5V$ and various external ceramic capacitor combinations.

Cext	1x47µF	2x47µF	4x47µF	10x47µF	20x47µF
R_{TUNE}	47	47	47	33	22
C_{TUNE}	1500pF	3900pF	10nF	33nF	56nF

Table 3. Recommended values of R_{TUNE} and C_{TUNE} to obtain transient deviation of 2% of V_{out} for a 6A step load with $V_{in}=5V$.

Vout	3.3V	2.5V	1.8V	1.2V	0.6V
Cext	330µF Polymer Cap	1x47µF + 330µF Polymer Cap	4x47µF + 330µF Polymer Cap	4x47µF + 2x330µF Polymer Cap	6x330µF Polymer Cap
R_{TUNE}	56	33	33	33	33
C_{TUNE}	15nF	18nF	27nF	47nF	220nF
ΔV	66mV	49mV	35mV	24mV	12mV

Table 4. General recommended values of R_{TUNE} and C_{TUNE} for $V_{in}=3.3V$ and various external ceramic capacitor combinations.

Cext	1x47µF	2x47µF	4x47µF	10x47µF	20x47µF
R_{TUNE}	47	47	33	33	22
C_{TUNE}	3300pF	6800pF	15nF	47nF	68nF

Table 5. Recommended values of R_{TUNE} and C_{TUNE} to obtain transient deviation of 2% of V_{out} for a 6A step load with $V_{in}=3.3V$.

Vout	2.5V	1.8V	1.2V	0.6V
Cext	2 x 330µF Polymer Ca	2 x 330µF Polymer Cap	3 x 330µF Polymer Cap	7 x 330µF Polymer Cap
R_{TUNE}	33	33	33	33
C_{TUNE}	82nF	100nF	180nF	390nF
ΔV	45mV	32mV	24mV	12mV

MicroTlynx™ 12A: Non-Isolated DC-DC Power Modules

2.4Vdc -5.5Vdc input; 0.6Vdc to 3.63Vdc output; 12A Output Current

Thermal Considerations

Power modules operate in a variety of thermal environments; however, sufficient cooling should always be provided to help ensure reliable operation.

Considerations include ambient temperature, airflow, module power dissipation, and the need for increased reliability. A reduction in the operating temperature of the module will result in an increase in reliability. The thermal data presented here is based on physical measurements taken in a wind tunnel. The test set-up is shown in Figure 45. The preferred airflow direction for the module is shown in Figure 46.

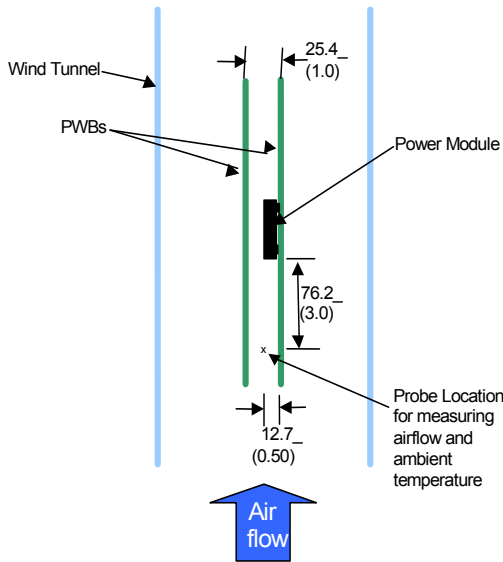

Figure 45. Thermal Test Setup.

The thermal reference points, T_{ref} used in the specifications are shown in Figure 46. For reliable operation the temperatures at these points should not exceed 125°C. The output power of the module should not exceed the rated power of the module ($V_{o,set} \times I_{o,max}$).

Please refer to the Application Note “Thermal Characterization Process For Open-Frame Board-Mounted Power Modules” for a detailed discussion of thermal aspects including maximum device temperatures.

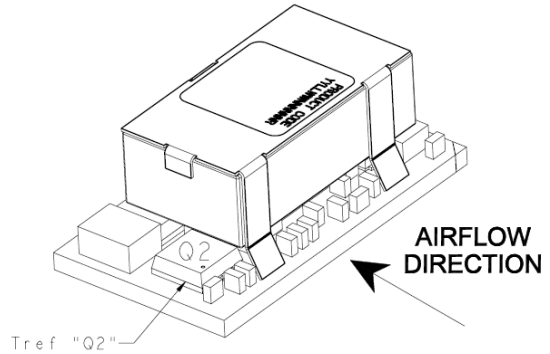

Figure 46. Preferred airflow direction and location of hot-spot of the module (T_{ref}).

MicroTLynx™ 12A: Non-Isolated DC-DC Power Modules

2.4Vdc –5.5Vdc input; 0.6Vdc to 3.63Vdc output; 12A Output Current

Example Application Circuit

Requirements:

V _{in} :	3.3V
V _{out} :	1.8V
I _{out} :	9A max., worst case load transient is from 6A to 9A
ΔV _{out} :	1.5% of V _{out} (27mV) for worst case load transient
V _{in} , ripple	1.5% of V _{in} (50mV, p-p)

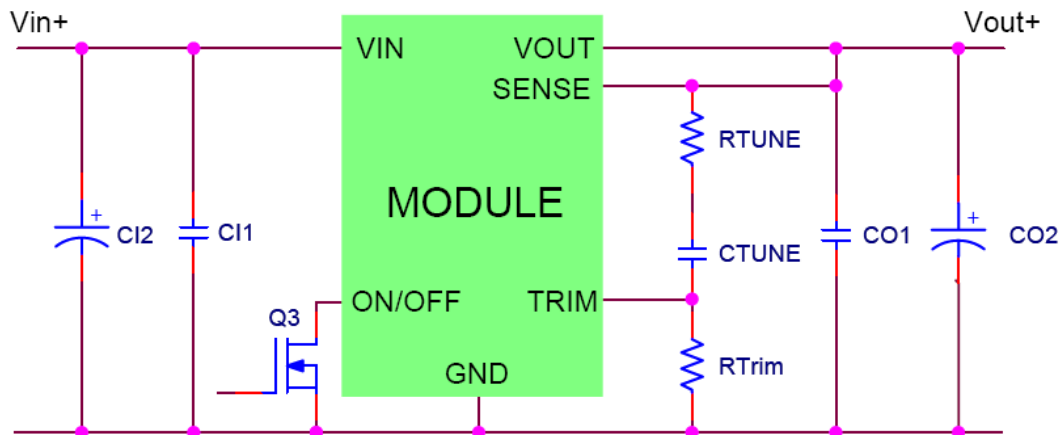

C11	2 × 47μF/6.3V ceramic capacitor (e.g. TDK C Series)
C12	100μF/6.3V Bulk Electrolytic
CO1	6 × 47μF/6.3V ceramic capacitor (e.g. TDK C Series)
CO2	330μF/6.3V Polymer/poscap (e.g. Sanyo Poscap)
CTune	56nF ceramic capacitor (can be 1206, 0805 or 0603 size)
RTune	33 ohms SMT resistor (can be 1206, 0805 or 0603 size)
RTrim	1kΩ SMT resistor (can be 1206, 0805 or 0603 size, recommended tolerance of 0.1%)

MicroTlynx™ 12A: Non-Isolated DC-DC Power Modules

2.4Vdc -5.5Vdc input; 0.6Vdc to 3.63Vdc output; 12A Output Current

Mechanical Outline

Dimensions are in millimeters and (inches).

Tolerances: x.x mm ± 0.5 mm (x.xx in. ± 0.02 in.) [unless otherwise indicated]

x.xxx mm ± 0.25 mm (x.xxx in ± 0.010 in.)

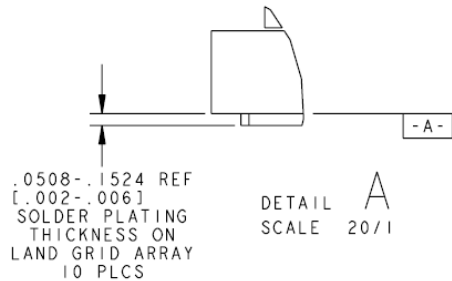
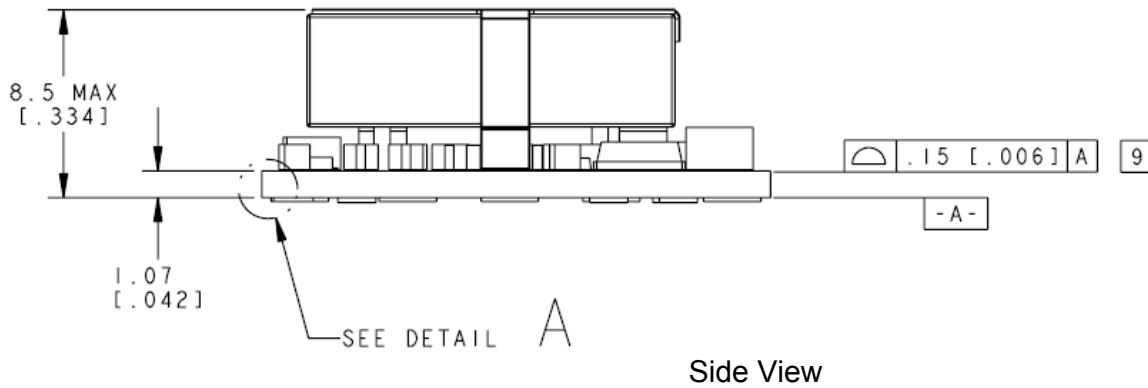
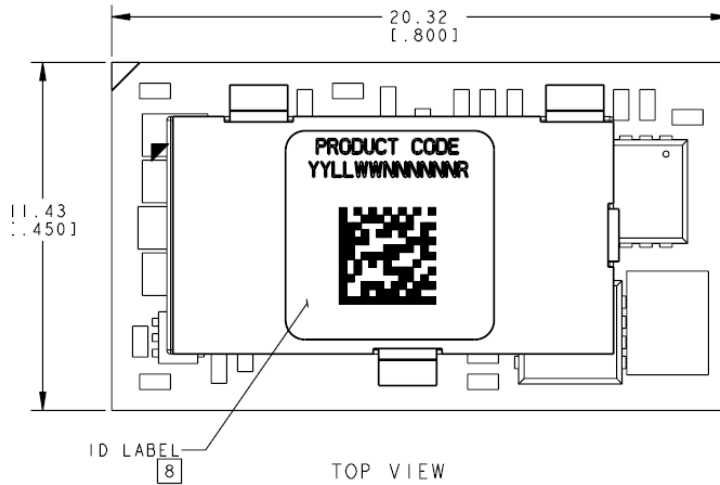

MicroTlynx™ 12A: Non-Isolated DC-DC Power Modules

2.4Vdc –5.5Vdc input; 0.6Vdc to 3.63Vdc output; 12A Output Current

Recommended Pad Layout

Dimensions are in millimeters and (inches).

Tolerances: x.x mm ± 0.5 mm (x.xx in. ± 0.02 in.) [unless otherwise indicated]

x.xx mm ± 0.25 mm (x.xxx in ± 0.010 in.)

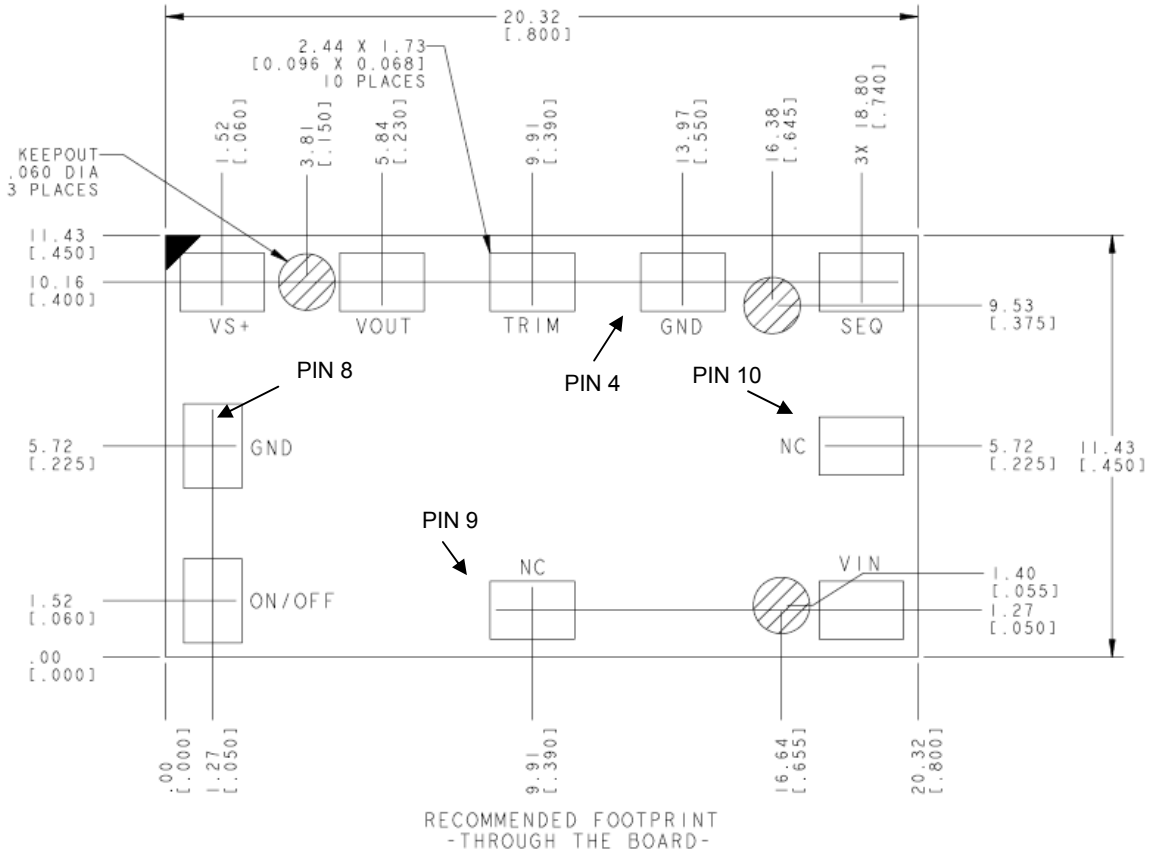

PIN	FUNCTION
1	ON/OFF
2	VIN
3	SEQ
4	GND
5	TRIM
6	VOUT
7	VS+
8	GND
9	NC
10	NC

MicroTlynx™ 12A: Non-Isolated DC-DC Power Modules

2.4Vdc –5.5Vdc input; 0.6Vdc to 3.63Vdc output; 12A Output Current

Packaging Details

The APTH012A0X modules are supplied in tape & reel as standard. Modules are shipped in quantities of 250 modules per reel. All Dimensions are in millimeters and (in inches).

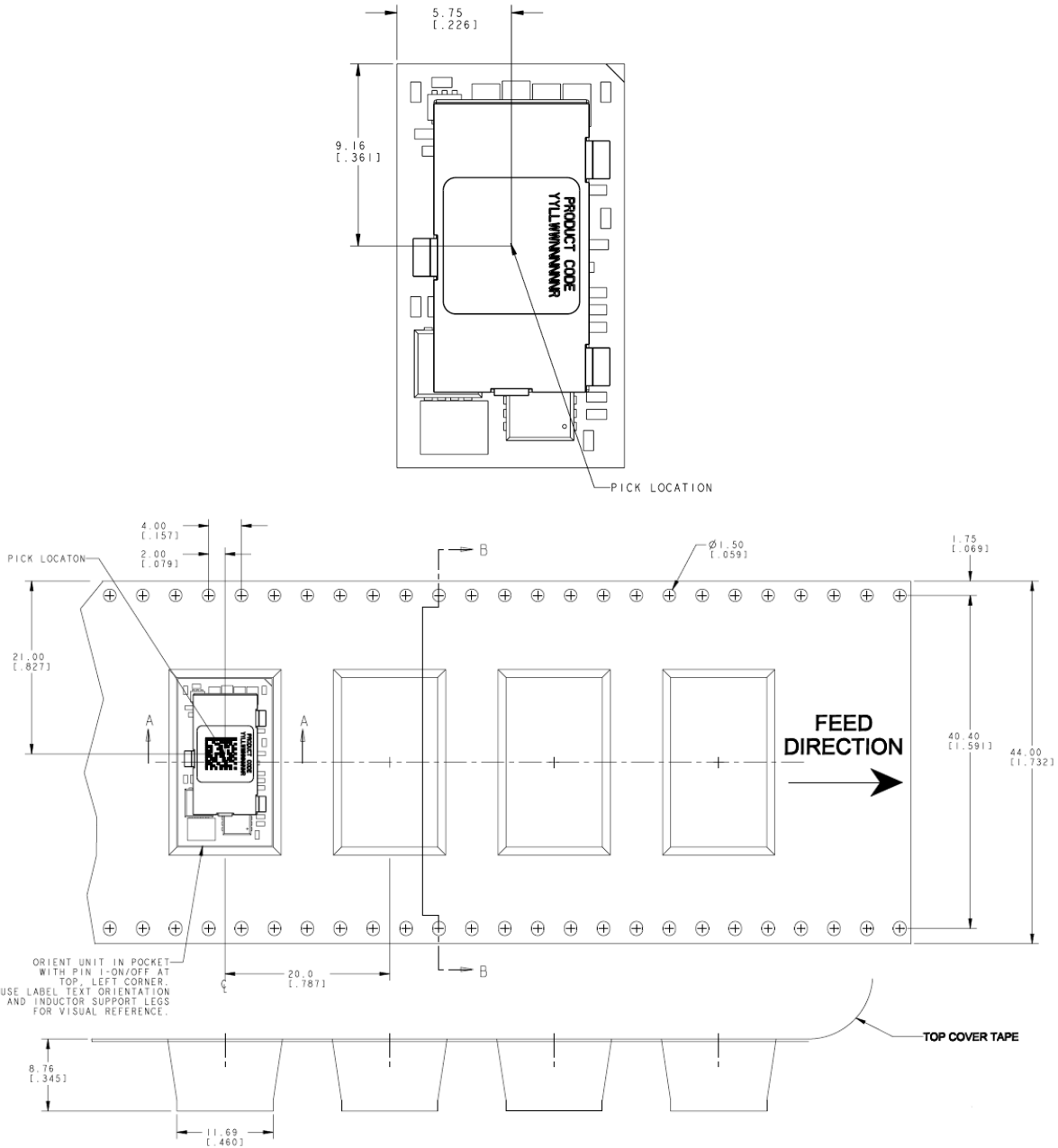

- Reel Dimensions:
- Outside Dimensions: 330.2 mm (13.00)
- Inside Dimensions: 177.8 mm (7.00")
- Tape Width: 44.00 mm (1.732")

MicroTLynx™ 12A: Non-Isolated DC-DC Power Modules

2.4Vdc –5.5Vdc input; 0.6Vdc to 3.63Vdc output; 12A Output Current

Surface Mount Information

Pick and Place

The Micro TLynx™ modules use an open frame construction and are designed for a fully automated assembly process. The modules are fitted with a label designed to provide a large surface area for pick and place operations. The label meets all the requirements for surface mount processing, as well as safety standards, and is able to withstand reflow temperatures of up to 300°C. The label also carries product information such as product code, serial number and the location of manufacture.

Nozzle Recommendations

The module weight has been kept to a minimum by using open frame construction. Variables such as nozzle size, tip style, vacuum pressure and placement speed should be considered to optimize this process. The minimum recommended inside nozzle diameter for reliable operation is 3mm. The maximum nozzle outer diameter, which will safely fit within the allowable component spacing, is 7 mm.

Bottom Side / First Side Assembly

This module is not recommended for assembly on the bottom side of a customer board. If such an assembly is attempted, components may fall off the module during the second reflow process. If assembly on the bottom side is planned, please contact Lineage Power for special manufacturing process instructions.

Only ruggedized (-D version) modules with additional epoxy will work with a customer's first side assembly. For other versions, first side assembly should be avoided.

Lead Free Soldering

The Micro TLynx™ modules are lead-free (Pb-free) and RoHS compliant and fully compatible in a Pb-free soldering process. Failure to observe the instructions below may result in the failure of or cause damage to the modules and can adversely affect long-term reliability.

Pb-free Reflow Profile

Power Systems will comply with J-STD-020 Rev. C (Moisture/Reflow Sensitivity Classification for Nonhermetic Solid State Surface Mount Devices) for both Pb-free solder profiles and MSL classification procedures. This standard provides a recommended forced-air-convection reflow profile based on the volume and thickness of the package (table 4-2). The suggested Pb-free solder paste is Sn/Ag/Cu (SAC). A 6 mil thick stencil is recommended.

For questions regarding Land grid array(LGA) soldering, solder volume; please contact Lineage Power for special manufacturing process instructions.

The recommended linear reflow profile using Sn/Ag/Cu solder is shown in Fig. 47. Soldering outside of the recommended profile requires testing to verify results and performance.

MSL Rating

The Micro TLynx™ modules have a MSL rating of 2a.

Storage and Handling

The recommended storage environment and handling procedures for moisture-sensitive surface mount packages is detailed in J-STD-033 Rev. A (Handling, Packing, Shipping and Use of Moisture/Reflow Sensitive Surface Mount Devices). Moisture barrier bags (MBB) with desiccant are required for MSL ratings of 2 or greater. These sealed packages should not be broken until time of use. Once the original package is broken, the floor life of the product at conditions of $\leq 30^{\circ}\text{C}$ and 60% relative humidity varies according to the MSL rating (see J-STD-033A). The shelf life for dry packed SMT packages will be a minimum of 12 months from the bag seal date, when stored at the following conditions: $< 40^{\circ}\text{C}$, $< 90\%$ relative humidity.

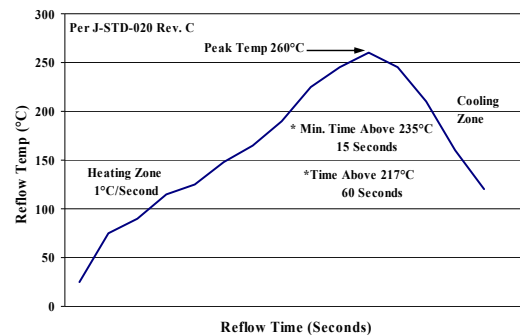

Figure 47. Recommended linear reflow profile using Sn/Ag/Cu solder.

Post Solder Cleaning and Drying Considerations

Post solder cleaning is usually the final circuit-board assembly process prior to electrical board testing. The result of inadequate cleaning and drying can affect both the reliability of a power module and the testability of the finished circuit-board assembly. For guidance on appropriate soldering, cleaning and drying procedures, refer to *Board Mounted Power Modules: Soldering and Cleaning Application Note (AN04-001)*.

MicroTlynx™ 12A: Non-Isolated DC-DC Power Modules

2.4Vdc –5.5Vdc input; 0.6Vdc to 3.63Vdc output; 12A Output Current

Ordering Information

Please contact your Lineage Power Sales Representative for pricing, availability and optional features.

Table 6. Device Codes

Device Code	Input Voltage Range	Output Voltage	Output Current	On/Off Logic	Connector Type	Comcodes
APTH012A0X3-SRZ	2.4 – 5.5Vdc	0.6 – 3.63Vdc	12A	Negative	SMT	CC109130465
APTH012A0X43-SRZ	2.4 – 5.5Vdc	0.6 – 3.63Vdc	12A	Positive	SMT	CC109130473
APXH012A0X3-SRZ	2.4 – 5.5Vdc	0.6 – 3.63Vdc	12A	Negative	SMT	CC109130481
APXH012A0X43-SRZ	2.4 – 5.5Vdc	0.6 – 3.63Vdc	12A	Positive	SMT	CC109130498

Table 7. Coding Scheme

Tlynx family	Sequencing feature.	Input voltage range	Output current	Output voltage	On/Off logic	Options	ROHS Compliance
AP	T	H	012A0	X	4	-SR	Z
	T = with Seq. X = w/o Seq.	H = 2.4 – 5.5V	12.0A	X = programmable output	4 = positive No entry = negative	S = Surface Mount R = Tape&Reel	Z = ROHS6



imagination at work

Contact Us

For more information, call us at

USA/Canada:

+1 888 546 3243, or +1 972 244 9288

Asia-Pacific:

+86.021.54279977*808

Europe, Middle-East and Africa:

+49.89.74423-206

India:

+91.80.28411633

www.ge.com/powerelectronics

Компания «Life Electronics» занимается поставками электронных компонентов импортного и отечественного производства от производителей и со складов крупных дистрибьюторов Европы, Америки и Азии.

С конца 2013 года компания активно расширяет линейку поставок компонентов по направлению коаксиальный кабель, кварцевые генераторы и конденсаторы (керамические, пленочные, электролитические), за счёт заключения дистрибьюторских договоров

Мы предлагаем:

- Конкурентоспособные цены и скидки постоянным клиентам.
- Специальные условия для постоянных клиентов.
- Подбор аналогов.
- Поставку компонентов в любых объемах, удовлетворяющих вашим потребностям.
- Приемлемые сроки поставки, возможна ускоренная поставка.
- Доставку товара в любую точку России и стран СНГ.
- Комплексную поставку.
- Работу по проектам и поставку образцов.
- Формирование склада под заказчика.
- Сертификаты соответствия на поставляемую продукцию (по желанию клиента).
- Тестирование поставляемой продукции.
- Поставку компонентов, требующих военную и космическую приемку.
- Входной контроль качества.
- Наличие сертификата ISO.

В составе нашей компании организован Конструкторский отдел, призванный помогать разработчикам, и инженерам.

Конструкторский отдел помогает осуществить:

- Регистрацию проекта у производителя компонентов.
- Техническую поддержку проекта.
- Защиту от снятия компонента с производства.
- Оценку стоимости проекта по компонентам.
- Изготовление тестовой платы монтаж и пусконаладочные работы.



Тел: +7 (812) 336 43 04 (многоканальный)

Email: org@lifeelectronics.ru