

Slide Switches, Instrumentation Grade

SEE PAGE B20 FOR PRODUCT SPECIFICATIONS

B
MSS Series

4P3T



MSS4300R

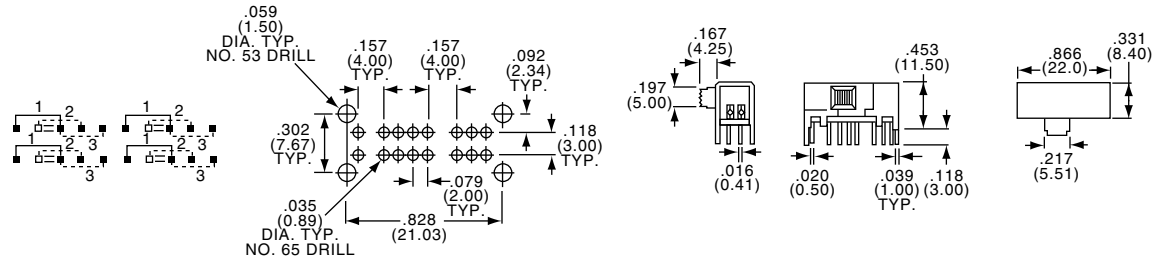

Tyco Electronics	Alcoswitch	Plating
7-1437576-7	MSS4300R	Silver
7-1437576-8	MSS4300RG	Gold

4P3T



MSS4350R

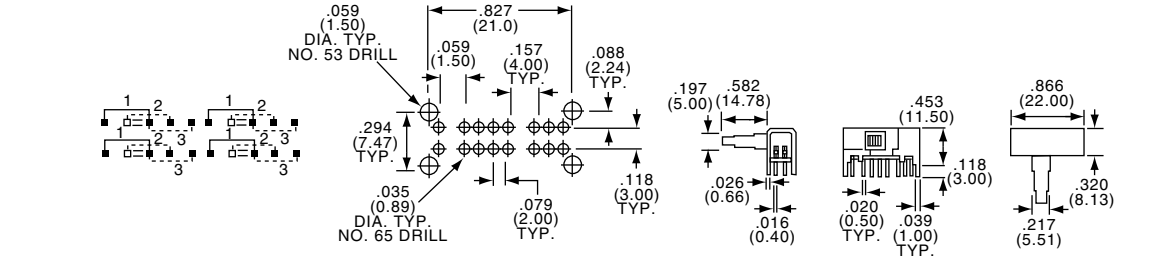

Tyco Electronics	Alcoswitch	Plating
8-1437576-0	MSS4350R	Silver
8-1437576-1	MSS4350RG	Gold

6PDT



MSS6200

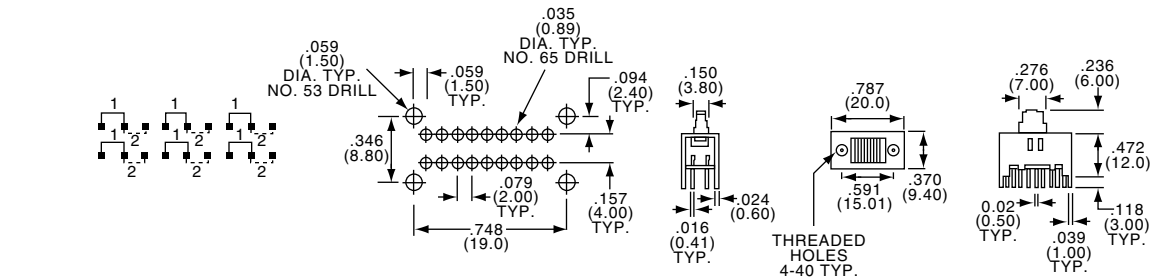

Tyco Electronics	Alcoswitch	Plating
8-1437576-8	MSS6200	Silver
8-1437576-9	MSS6200G	Gold

Slide Switches, Instrumentation Grade

SEE PAGE B20 FOR PRODUCT SPECIFICATIONS

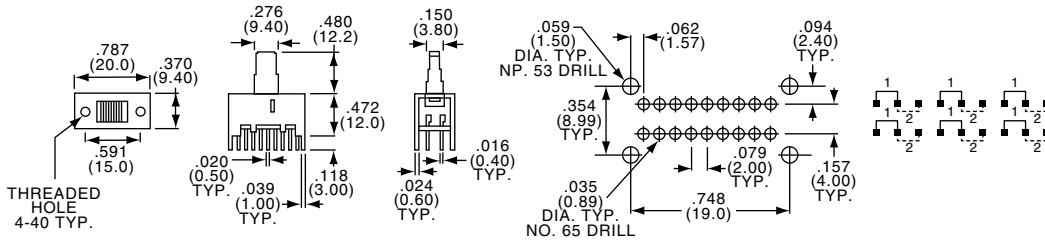

6PDT



MSS6250

Tyco Electronics	Alcoswitch	Plating
9-1437576-0	MSS6250	Silver

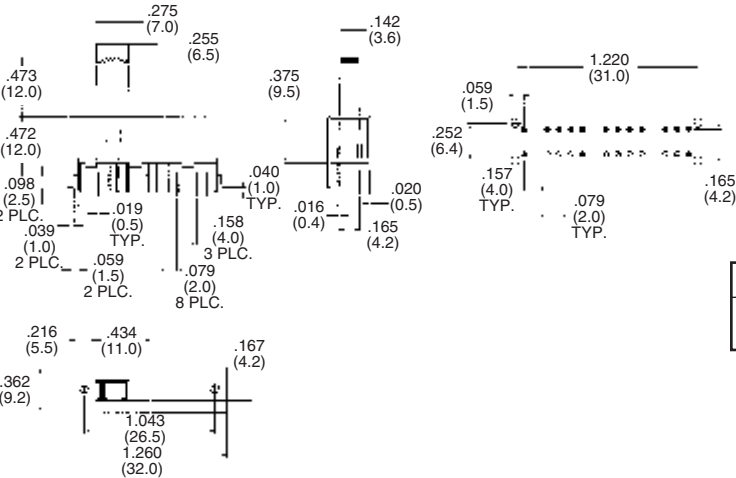

Tyco Electronics	Alcoswitch	Plating
9-1437576-3	MSS6350	Silver
—	MSS6350G	Gold

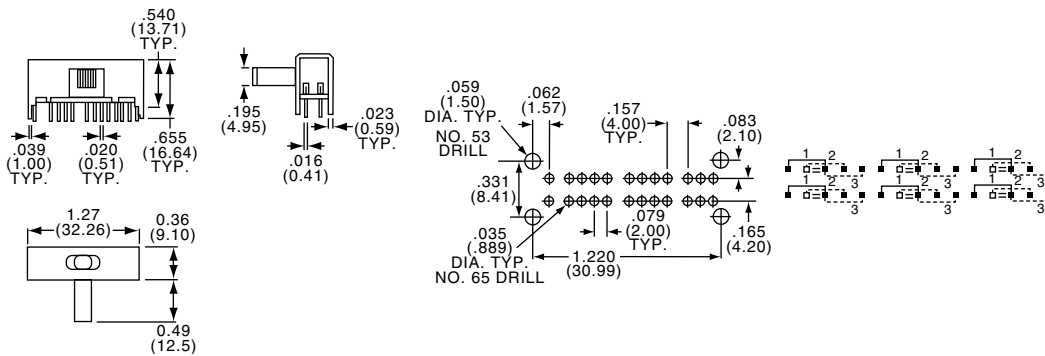

6P3T



MSS6350R

Tyco Electronics	Alcoswitch	Plating
9-1437576-4	MSS6350R	Silver
—	MSS6350RG	Gold

Slide Switches, Instrumentation Grade

MATERIAL SPECIFICATIONS:

ContactsSilver or gold over copper alloy
 Case MaterialCold rolled steel
 Actuator MaterialPolyester UL94V-0
 Terminals/Fixed Contacts.....Gold or silver plate over copper alloy
 Terminal SealEpoxy

ENVIRONMENTAL SPECIFICATIONS:

Operating Temperature.....-4°F to +185°F (-20°C to +85°C)
 Storage Temperature.....-40°F to +212°F (-40°C to +100°C)
 Solder Heat Resistance.....See page M3-4

TYPICAL PERFORMANCE CHARACTERISTICS:

Contact RatingGold: 0.4 VA 20 VDC or peak AC
 Silver: 300 mA @ 125 VAC
 Initial Contact Resistance30 Milliohms max.
 Contact Timing.....Make before break
 Insulation Resistance1,000 Megohms min.
 Dielectric Strength500 Volts RMS @ sea level
 Actuation Force600±300/470 Grams average
 Actuator Travel.....0.079" (2.01) approximate
 Life ExpectancyUp to 15,000 Cycles

B
MSSA Series

SP3T

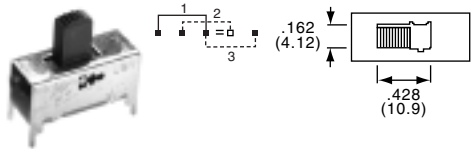

MSSA1350

Tyco Electronics	Alcoswitch	Plating	Mounting Style
3-1437580-3	MSSA1350	Silver	Upright
3-1437580-4	MSSA1350G	Gold	Upright

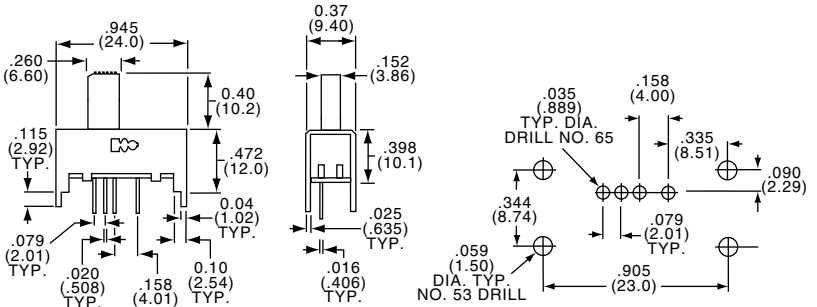

SP3T

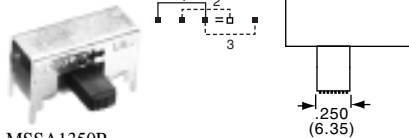

MSSA1350R

Tyco Electronics	Alcoswitch	Plating	Mounting Style
3-1437580-5	MSSA1350R	Silver	Rt. Angle
3-1437580-6	MSSA1350RG	Gold	Rt. Angle

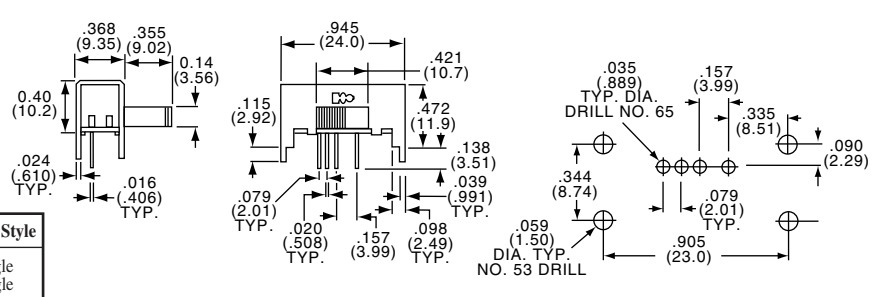

SP4T

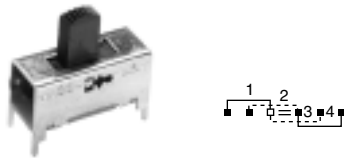

MSSA1450

Tyco Electronics	Alcoswitch	Plating	Mounting Style
3-1437580-7	MSSA1450	Silver	Upright
3-1437580-8	MSSA1450G	Gold	Upright

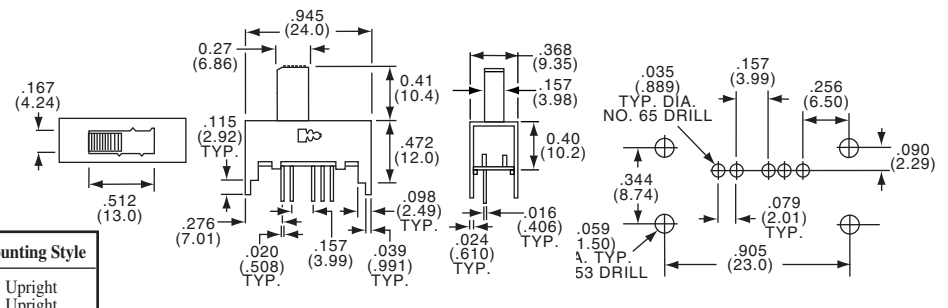

SP4T

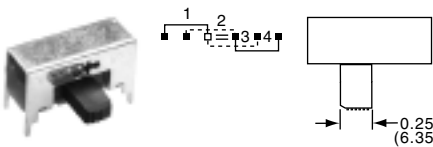

MSSA1450R

Tyco Electronics	Alcoswitch	Plating	Mounting Style
3-1437580-9	MSSA1450R	Silver	Rt. Angle
4-1437580-0	MSSA1450RG	Gold	Rt. Angle

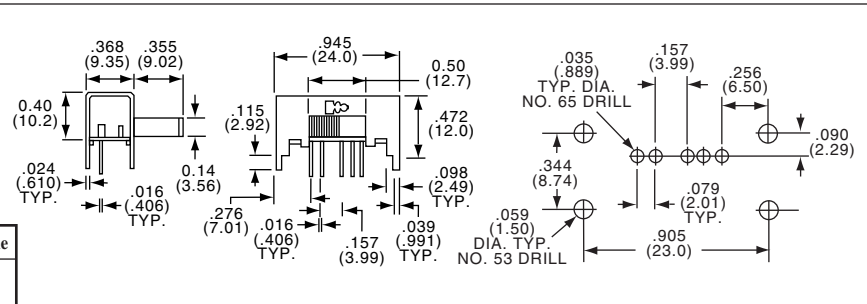

Slide Switches, Instrumentation Grade

SEE PAGE B26 FOR PRODUCT SPECIFICATIONS

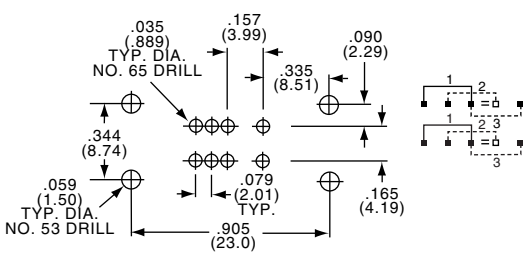
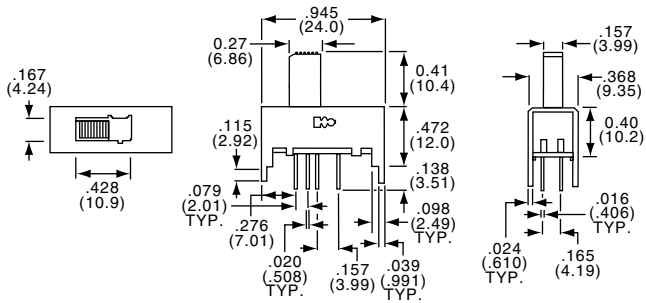

Tyco Electronics	Alcoswitch	Plating	Mounting Style
5-1437580-3	MSSA2350	Silver	Upright
5-1437580-4	MSSA2350G	Gold	Upright

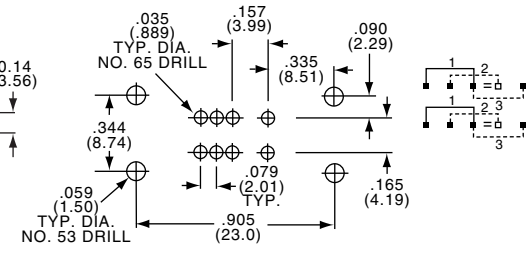
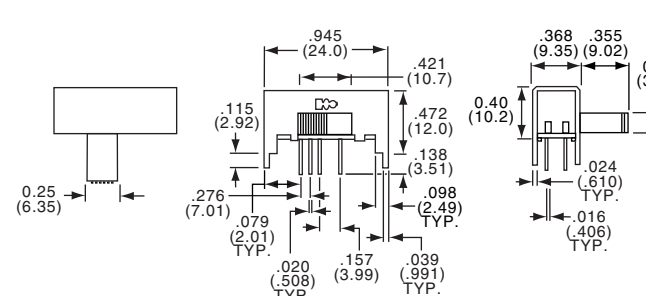

Tyco Electronics	Alcoswitch	Plating	Mounting Style
5-1437580-5	MSSA2350R	Silver	Rt. Angle
5-1437580-6	MSSA2350RG	Gold	Rt. Angle

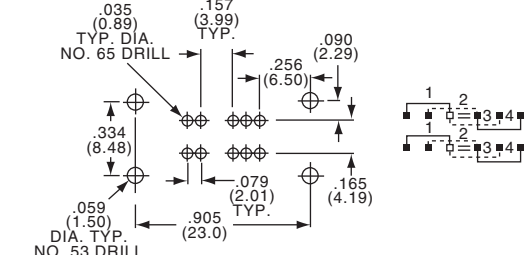
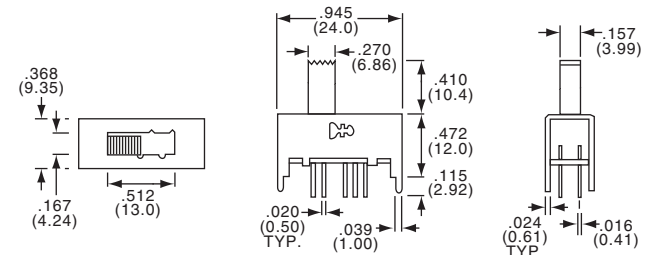

Tyco Electronics	Alcoswitch	Plating	Mounting Style
5-1437580-7	MSSA2450	Silver	Upright
5-1437580-8	MSSA2450G	Gold	Upright

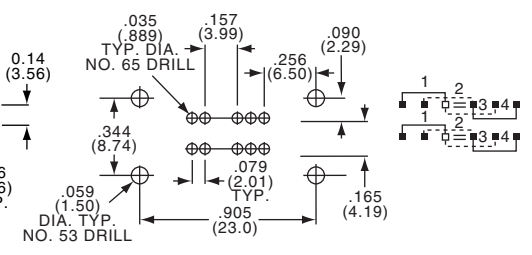
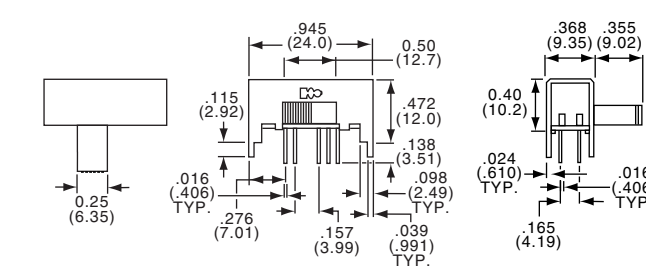

Tyco Electronics	Alcoswitch	Plating	Mounting Style
5-1437580-9	MSSA2450R	Silver	Rt. Angle
6-1437580-0	MSSA2450RG	Gold	Rt. Angle

Slide Switches, Instrumentation Grade

SEE PAGE B26 FOR PRODUCT SPECIFICATIONS

3P3T



MSSA3350

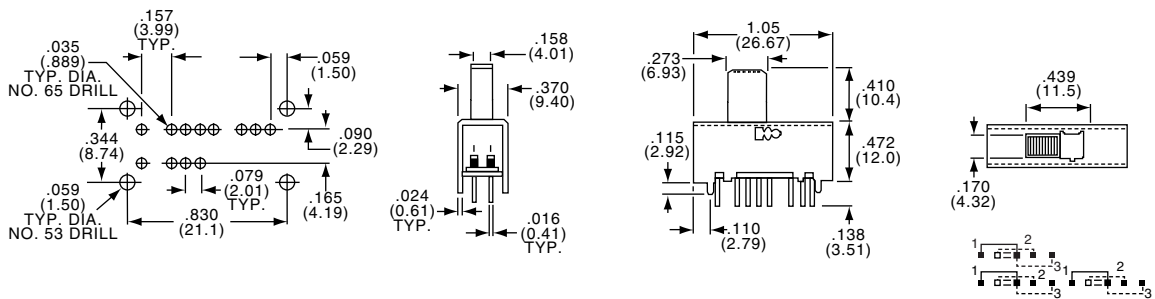

Tyco Electronics	Alcoswitch	Plating	Mounting Style
6-1437580-1	MSSA3350	Silver	Upright
6-1437580-2	MSSA3350G	Gold	Upright

3P3T



MSSA3350R

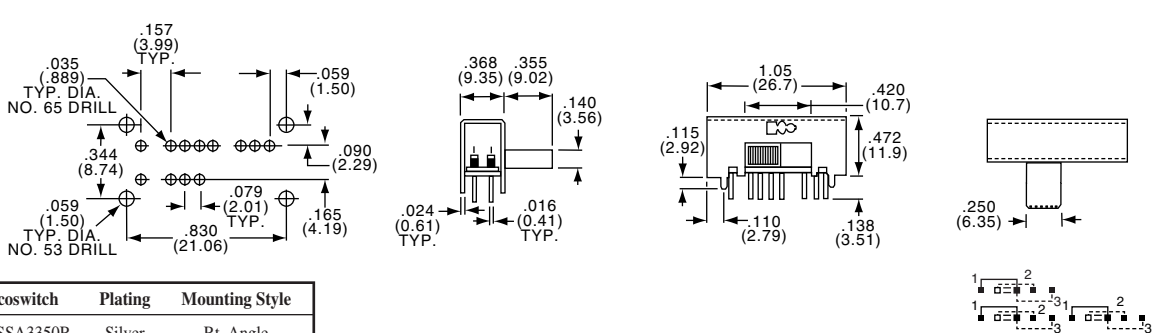

Tyco Electronics	Alcoswitch	Plating	Mounting Style
6-1437580-3	MSSA3350R	Silver	Rt. Angle
6-1437580-4	MSSA3350RG	Gold	Rt. Angle

3P4T



MSSA3450

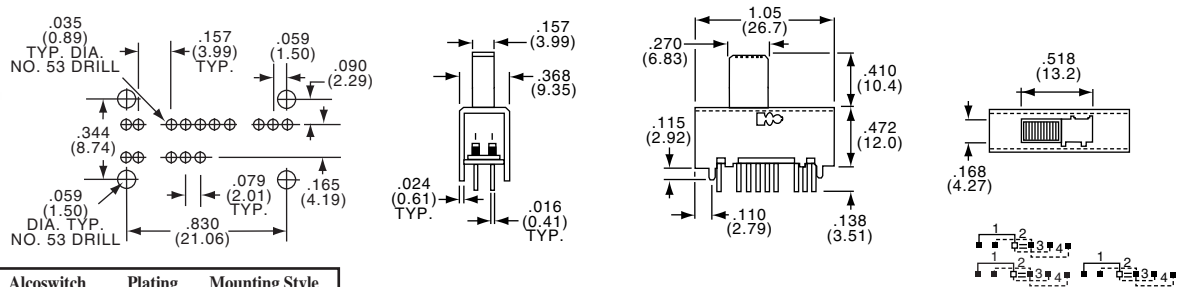

Tyco Electronics	Alcoswitch	Plating	Mounting Style
6-1437580-5	MSSA3450	Silver	Upright
6-1437580-6	MSSA3450G	Gold	Upright

3P4T



MSSA3450R

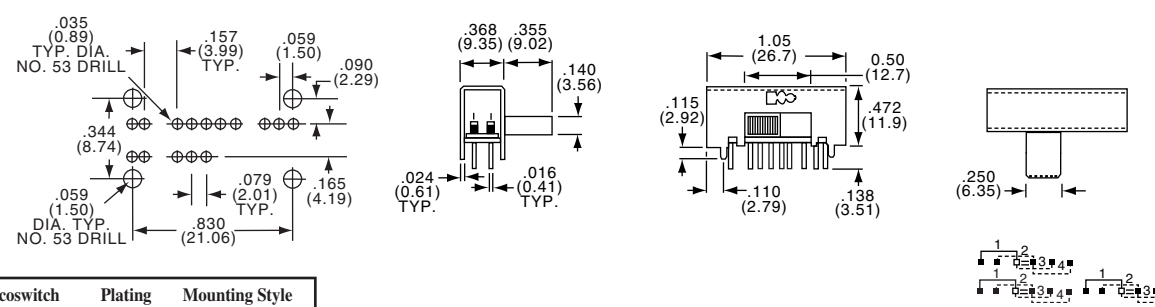

Tyco Electronics	Alcoswitch	Plating	Mounting Style
6-1437580-7	MSSA3450R	Silver	Rt. Angle
6-1437580-8	MSSA3450RG	Gold	Rt. Angle

Slide Switches, Instrumentation Grade

SEE PAGE B26 FOR PRODUCT SPECIFICATIONS

4P3T

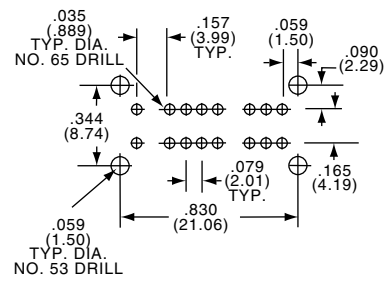
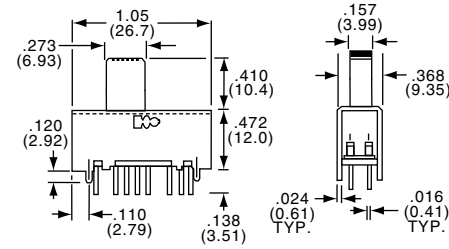
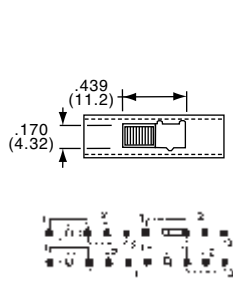

MSSA4350

Tyco Electronics	Alcoswitch	Plating	Mounting Style
6-1437580-9	MSSA4350	Silver	Upright
7-1437580-0	MSSA4350G	Gold	Upright

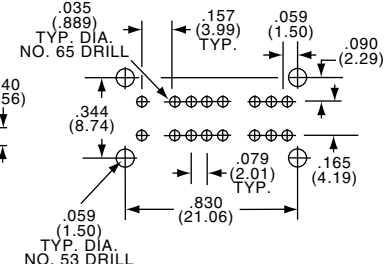
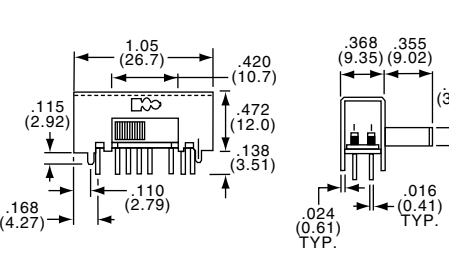
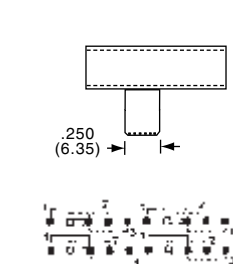

MSSA4350R

Tyco Electronics	Alcoswitch	Plating	Mounting Style
7-1437580-1	MSSA4350R	Silver	Rt. Angle
7-1437580-2	MSSA4350RG	Gold	Rt. Angle

4P3T

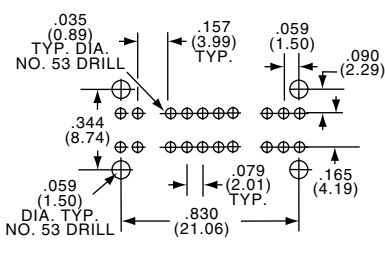
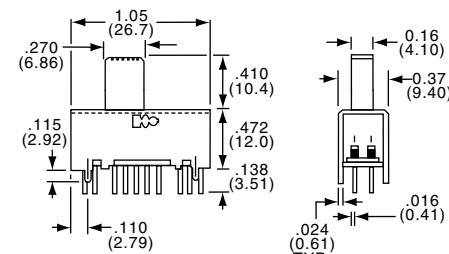
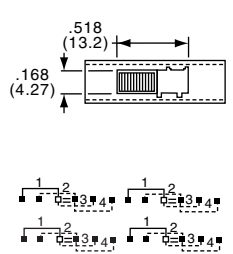

MSSA4450

Tyco Electronics	Alcoswitch	Plating	Mounting Style
7-1437580-3	MSSA4450	Silver	Upright
7-1437580-4	MSSA4450G	Gold	Upright

4P4T

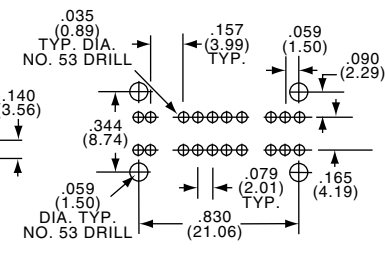
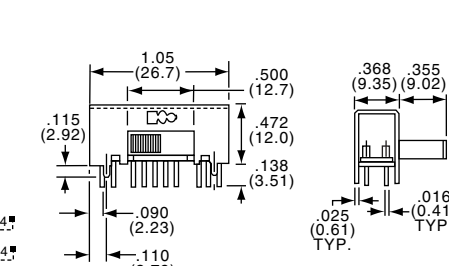
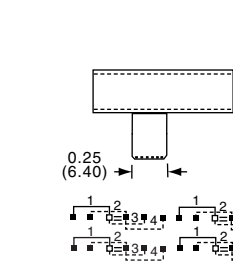

MSSA4450R

Tyco Electronics	Alcoswitch	Plating	Mounting Style
7-1437580-5	MSSA4450R	Silver	Rt. Angle
7-1437580-6	MSSA4450RG	Gold	Rt. Angle

4P4T

Компания «Life Electronics» занимается поставками электронных компонентов импортного и отечественного производства от производителей и со складов крупных дистрибьюторов Европы, Америки и Азии.

С конца 2013 года компания активно расширяет линейку поставок компонентов по направлению коаксиальный кабель, кварцевые генераторы и конденсаторы (керамические, пленочные, электролитические), за счёт заключения дистрибьюторских договоров

Мы предлагаем:

- Конкурентоспособные цены и скидки постоянным клиентам.
- Специальные условия для постоянных клиентов.
- Подбор аналогов.
- Поставку компонентов в любых объемах, удовлетворяющих вашим потребностям.
- Приемлемые сроки поставки, возможна ускоренная поставка.
- Доставку товара в любую точку России и стран СНГ.
- Комплексную поставку.
- Работу по проектам и поставку образцов.
- Формирование склада под заказчика.
- Сертификаты соответствия на поставляемую продукцию (по желанию клиента).
- Тестирование поставляемой продукции.
- Поставку компонентов, требующих военную и космическую приемку.
- Входной контроль качества.
- Наличие сертификата ISO.

В составе нашей компании организован Конструкторский отдел, призванный помогать разработчикам, и инженерам.

Конструкторский отдел помогает осуществить:

- Регистрацию проекта у производителя компонентов.
- Техническую поддержку проекта.
- Защиту от снятия компонента с производства.
- Оценку стоимости проекта по компонентам.
- Изготовление тестовой платы монтаж и пусконаладочные работы.



Тел: +7 (812) 336 43 04 (многоканальный)
Email: org@lifeelectronics.ru