

## Backlight Driver for 5 LEDs with Charge Pump and PWM Control

### POWER MANAGEMENT

#### Features

- Input supply voltage range — 2.9V to 5.5V
- Charge pump modes — 1x, 1.5x and 2x
- PWM dimming control with low pass filter provides DC backlight current (not pulsed)
- PWM frequency range — 200Hz to 50kHz
- Five adjustable current sinks — 500µA to 25mA
- Backlight current accuracy  $\pm 1.5\%$  typical
- Backlight current matching  $\pm 0.5\%$  typical
- LED float detection
- Charge pump frequency — 250kHz
- Low shutdown current — 0.1µA typical
- Ultra-thin package — 2 x 2 x 0.6(mm)
- Fully WEEE and RoHS compliant

#### Applications

- Cellular phones, smart phones, and PDAs
- LCD display modules
- Portable media players
- Digital cameras
- Personal navigation devices
- Display/keypad backlighting and LED indicators

#### Description

The SC652 is a high efficiency charge pump LED driver using Semtech's proprietary charge pump technology. Performance is optimized for use in single-cell Li-ion battery applications.

The device provides backlight current using up to five matched current sinks. The load and supply conditions determine whether the charge pump operates in 1x, 1.5x, or 2x mode.

The maximum current per LED is set by a resistor ( $R_{ISET}$ ) connected from the ISET pin to the input voltage. The current can be set between 500µA and 25mA. This current can be varied by applying a pulse-width modulated (PWM) signal to the EN/PWM pin. A low-pass filter is used to develop a DC current level rather than a pulsed current output, resulting in a more efficient system. The resulting DC current in each LED ( $I_{BL}$ ) is equal to the maximum current setting multiplied by the duty cycle of the PWM control signal. Using this control system,  $I_{BL}$  can gradually fade between levels.

With a 2 x 2 (mm) package and 4 small capacitors, the SC652 provides a complete LED driver solution with a minimal PCB footprint.

### Typical Application Circuit

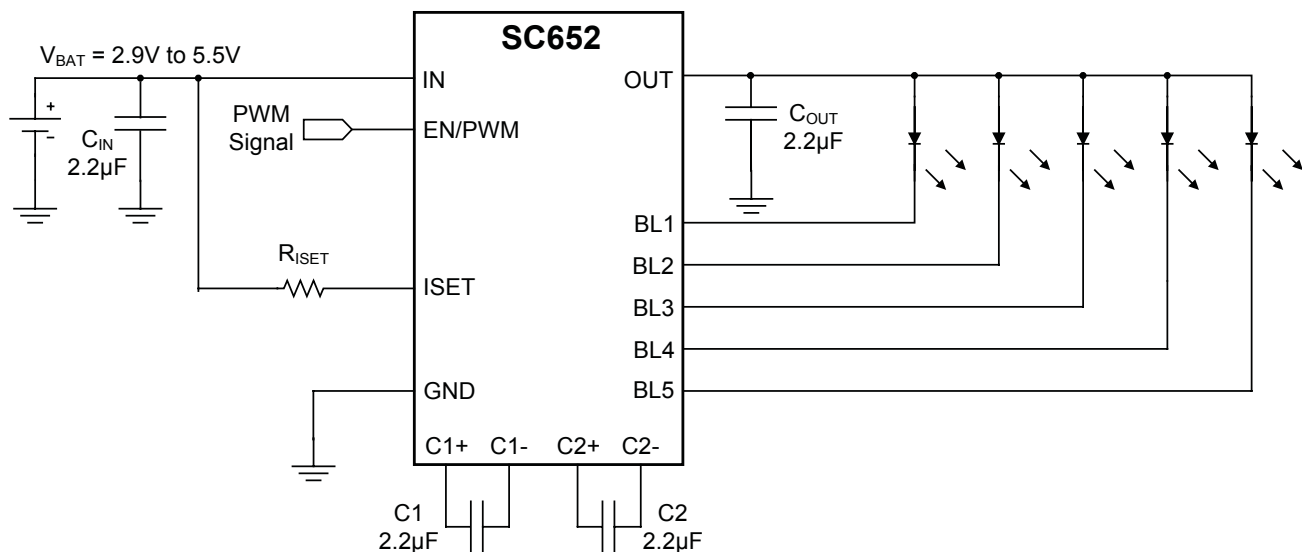

### Pin Configuration

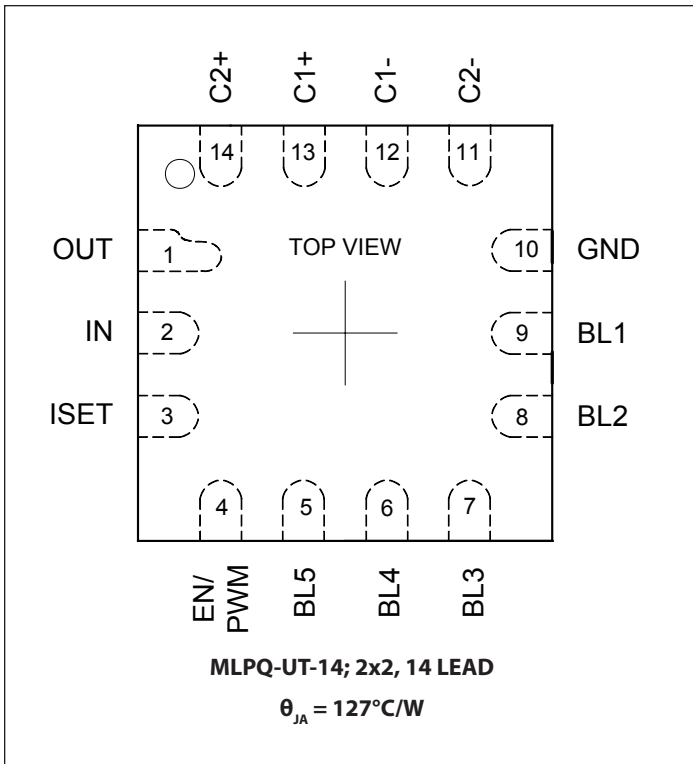

### Ordering Information

Device	Package
SC652ULTRT <sup>(1)(2)</sup>	MLPQ-UT-14 2x2
SC652EVB	Evaluation Board

Notes:

- (1) Available in tape and reel only. A reel contains 3,000 devices.
- (2) Lead-free package only. Device is WEEE and RoHS compliant.

### Marking Information

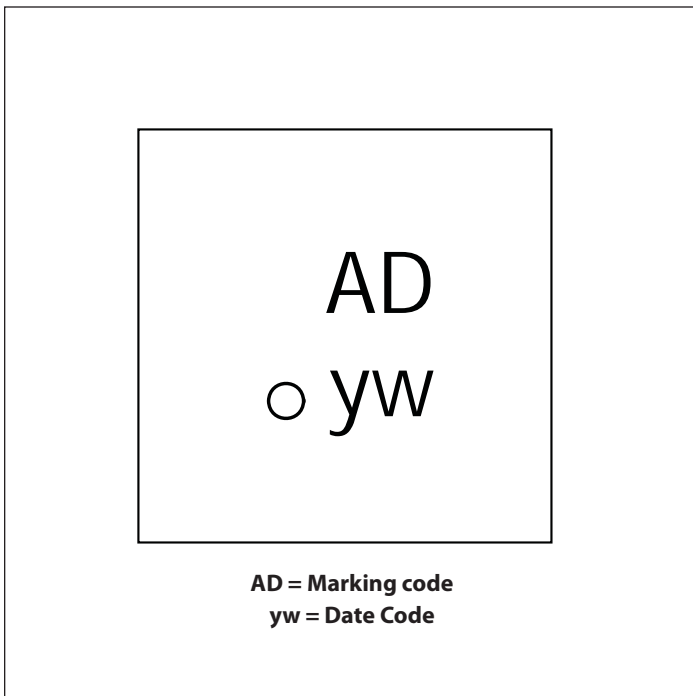

## Absolute Maximum Ratings

IN, OUT (V) .....	-0.3 to +6.0
C1+, C2+ (V) .....	-0.3 to (V <sub>OUT</sub> + 0.3)
Pin Voltage — All Other Pins (V) .....	-0.3 to (V <sub>IN</sub> + 0.3)
OUT Short Circuit Duration .....	Continuous
ESD Protection Level <sup>(1)</sup> (kV) .....	2

## Recommended Operating Conditions

Ambient Temperature Range (°C) .....	-40 ≤ T <sub>A</sub> ≤ +85
Input Voltage (V) .....	2.9 to 5.5
Output Voltage (V) .....	2.5 to 5.25
Voltage Difference between any two LEDs (V) ... ΔV <sub>F</sub> ≤ 1.0 <sup>(2)</sup>	

## Thermal Information

Thermal Resistance, Junction to Ambient <sup>(3)</sup> (°C/W) ...	127
Maximum Junction Temperature (°C) .....	+150
Storage Temperature Range (°C) .....	-65 to +150
Peak IR Reflow Temperature (10s to 30s) (°C) .....	+260

Exceeding the above specifications may result in permanent damage to the device or device malfunction. Operation outside of the parameters specified in the Electrical Characteristics section is not recommended.

### NOTES:

- (1) Tested according to JEDEC standard JESD22-A114-B.
- (2) ΔV<sub>F(max)</sub> = 1.0V when V<sub>IN</sub> = 2.9V, higher V<sub>IN</sub> supports higher ΔV<sub>F(max)</sub>
- (3) Calculated from package in still air, mounted to 3 x 4.5(in), 4 layer FR4 PCB per JESD51 standards.

## Electrical Characteristics

Unless otherwise noted, T<sub>A</sub> = +25°C for Typ, -40°C to +85°C for Min and Max, T<sub>J(MAX)</sub> = 125°C, V<sub>IN</sub> = 3.7V, C<sub>IN</sub> = C<sub>OUT</sub> = C<sub>1</sub> = C<sub>2</sub> = 2.2μF, (ESR = 0.03Ω), 500μA < I<sub>FS,BL</sub> < 25mA, Duty Cycle of PWM = 100%, All 5 LEDs connected and enabled.

Parameter	Symbol	Conditions	Min	Typ	Max	Units
Shutdown Current	I <sub>Q(OFF)</sub>	T <sub>A</sub> = 25°C		0.1	2	μA
Quiescent Current	I <sub>Q</sub>	Charge pump in 1x mode, 2.9V < V <sub>IN</sub> < 4.2V, 5 LEDs enabled		1.5		mA
		Charge pump in 1.5x mode, 2.9V < V <sub>IN</sub> < 4.2V, 5 LEDs enabled		2		
		Charge pump in 2x mode, 2.9V < V <sub>IN</sub> < 4.2V, 5 LEDs enabled		2.5		
Maximum Total Output Current	I <sub>OUT(MAX)</sub>	V <sub>IN</sub> > 3.0V, sum of all active LED currents, V <sub>OUT(MAX)</sub> = 4.2V	125			mA
Backlight Current Setting <sup>(1)</sup>	I <sub>FS,BL</sub>	PWM duty cycle = 100%, 200kΩ ≥ R <sub>ISET</sub> ≥ 4kΩ	0.5		25	mA
Current Gain	I <sub>GAIN</sub>	Gain from I <sub>ISET</sub> to I <sub>FS,BL</sub>		100		A/A
Current Set Voltage	V <sub>IN-ISET</sub>	Voltage across R <sub>ISET</sub>		1		V
Backlight Current Matching <sup>(2)</sup>	I <sub>BL-BL</sub>	I <sub>FS,BL</sub> = 12mA, Duty = 100%	-3.5	±0.5	+3.5	%
Backlight Current Accuracy	I <sub>BL-ACC</sub>	I <sub>FS,BL</sub> = 12mA, Duty = 100%		±1.5		%
PWM Input Frequency	f <sub>EN/PWM</sub>	Guaranteed by design	0.2		50	kHz
EN/PWM Minimum High Time	t <sub>HIGH_MIN</sub> <sup>(3)</sup>			1		μs

**Electrical Characteristics (continued)**

Parameter	Symbol	Conditions	Min	Typ	Max	Units
Current Transition Settling Time	$t_s$	Duty cycle change from 100% to 50% <sup>(1)(4)</sup>		0.5		s
EN/PWM Low Time	$t_{LT}$	Time that voltage on the EN/PWM pin can be low without disabling the device			5	ms
1x Mode to 1.5x Mode Falling Transition Voltage	$V_{TRANS1x}$	$I_{OUT} = 50mA, I_{BLn} = 10mA, V_{OUT} = 3.2V$		3.25		V
1.5x Mode to 1x Mode Hysteresis	$V_{HYST1x}$	$I_{OUT} = 50mA, I_{BLn} = 10mA, V_{OUT} = 3.2V$		300		mV
1.5x Mode to 2x Mode Falling Transition Voltage	$V_{TRANS1.5x}$	$I_{OUT} = 50mA, I_{BLn} = 10mA, V_{OUT} = 4.0V^{(5)}$		2.9		V
2x Mode to 1.5x Mode Hysteresis	$V_{HYST1.5x}$	$I_{OUT} = 50mA, I_{BLn} = 10mA, V_{OUT} = 4.0V^{(5)}$		500		mV
Current Sink Off-State Leakage Current	$I_{BLn(off)}$	$V_{IN} = V_{BLn} = 4.2V$		0.1	1	$\mu A$
Charge Pump Frequency	$f_{PUMP}$	$V_{IN} = 3.2V$		250		kHz
Output Short Circuit Current Limit	$I_{OUT(SC)}$	OUT pin shorted to GND		45		mA
		$V_{OUT} > 2.5V$		400		
Under Voltage Lockout Threshold	$V_{UVLO-OFF}$	Increasing $V_{IN}$ — lockout released		2.4		V
UVLO Hysteresis	$V_{UVLO-HYS}$			500		mV
Over-Voltage Protection	$V_{OVP}$	OUT pin open circuit, $V_{OUT} = V_{OVP}$ — rising threshold		5.7	6.0	V
Over-Temperature	$T_{OT}$	Rising Temperature		165		$^{\circ}C$
OT Hysteresis	$T_{OT-HYS}$			25		$^{\circ}C$
Input High Threshold <sup>(6)</sup>	$V_{IH}$	$V_{IN} = 5.5V$	1.4			V
Input Low Threshold <sup>(6)</sup>	$V_{IL}$	$V_{IN} = 2.9V$			0.4	V
Input High Current <sup>(6)</sup>	$I_{IH}$	$V_{IN} = 5.5V$			1	$\mu A$
Input Low Current <sup>(6)</sup>	$I_{IL}$	$V_{IN} = 5.5V$			1	$\mu A$

**Notes:**

- (1) Guaranteed by design
- (2) Current matching equals  $\pm [I_{BL(MAX)} - I_{BL(MIN)}] / [I_{BL(MAX)} + I_{BL(MIN)}]$ .
- (3)  $t_{HIGH\_MIN}$  is the minimum time needed for accurate PWM sampling.
- (4) The settling time is affected by the magnitude of change in the PWM duty cycle.
- (5) Test voltage is  $V_{OUT} = 4.0V$  — a relatively extreme LED voltage used to force a transition during test. Typically  $V_{OUT} = 3.2V$  for white LEDs.
- (6) Applied to EN/PWM pin.

## Typical Characteristics

**Backlight Accuracy (5 LEDs) — 25mA Each**

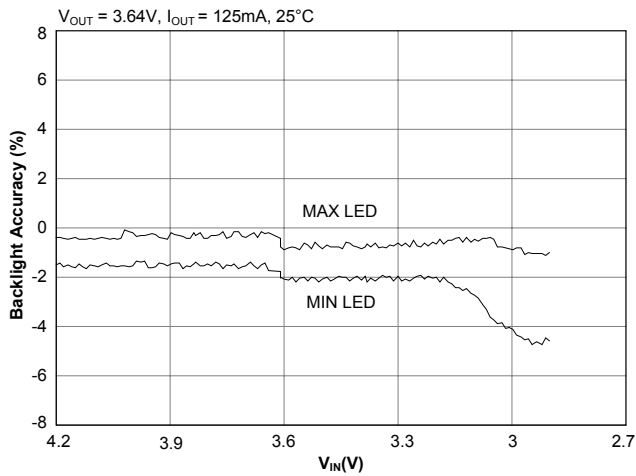

**Backlight Matching (5 LEDs) — 25mA Each**

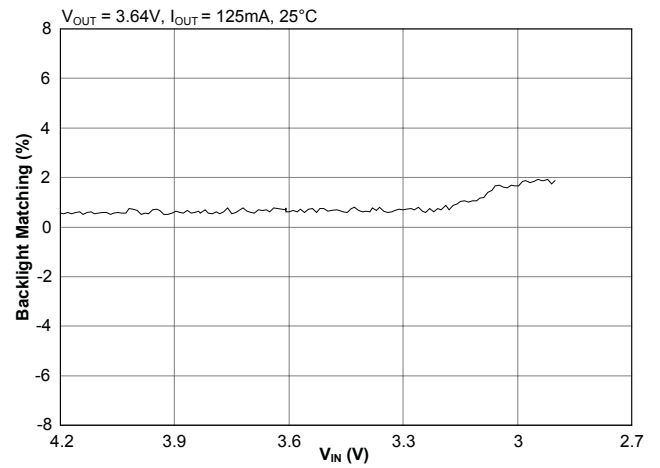

**Backlight Accuracy (5 LEDs) — 12mA Each**

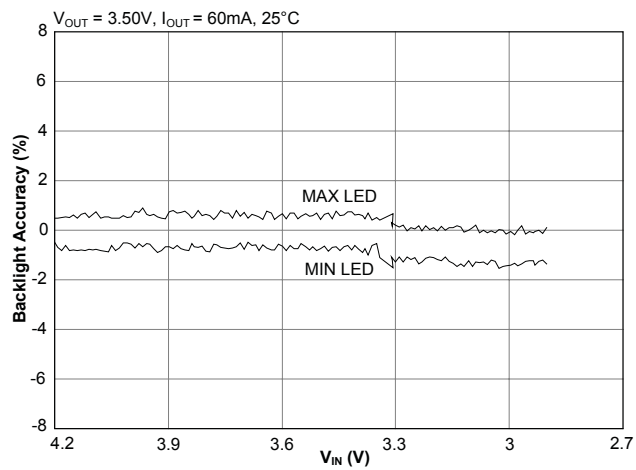

**Backlight Matching (5 LEDs) — 12mA Each**

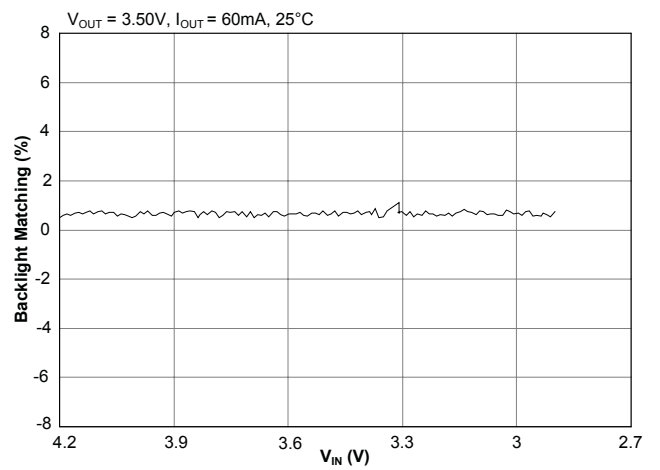

**Backlight Accuracy (5 LEDs) — 0.5mA Each**

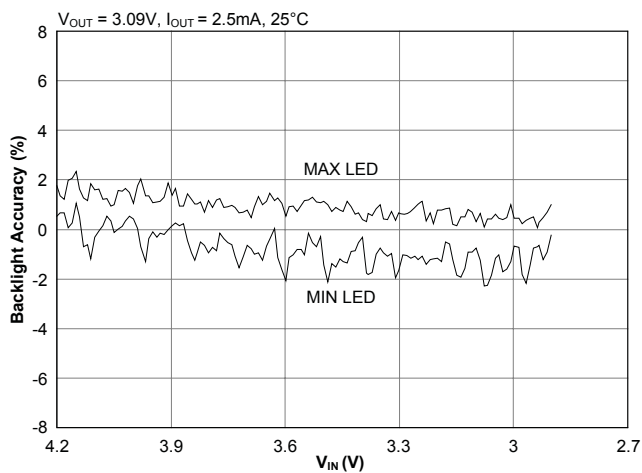

**Backlight Matching (5 LEDs) — 0.5mA Each**

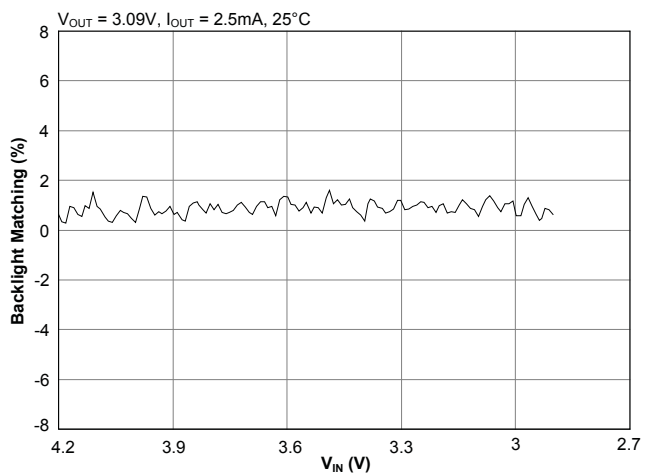

Typical Characteristics (continued)

Backlight Efficiency (5 LEDs) — 25mA Each

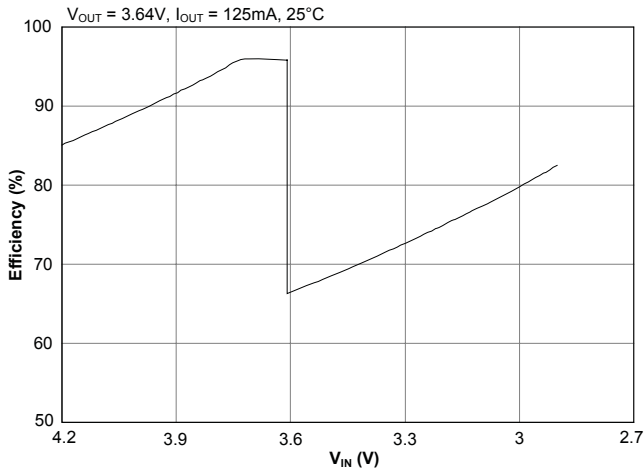

Battery Current (5 LEDs) — 25mA Each

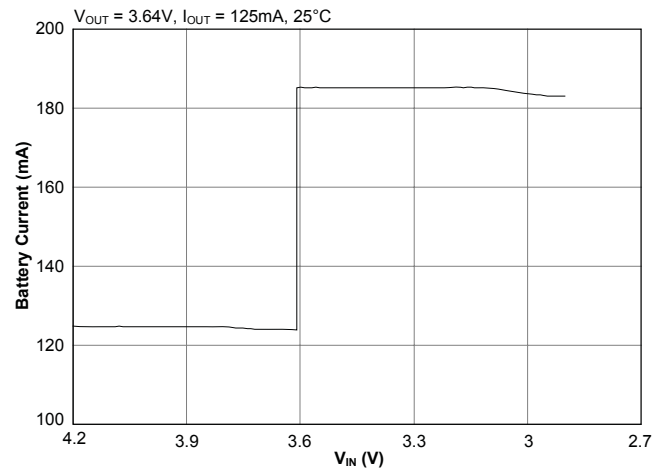

Backlight Efficiency (5 LEDs) — 12mA Each

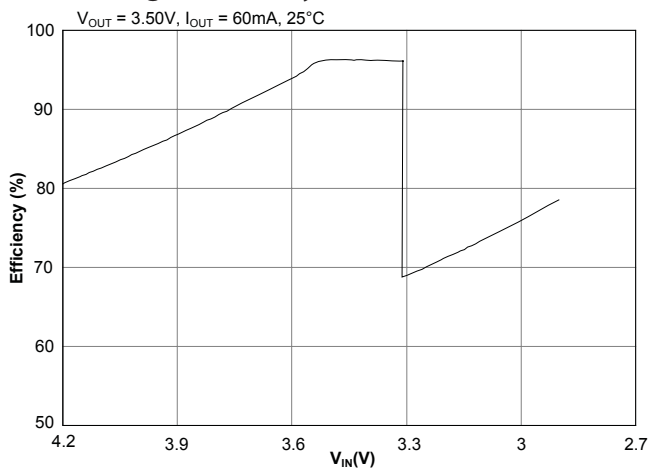

Battery Current (5 LEDs) — 12mA Each

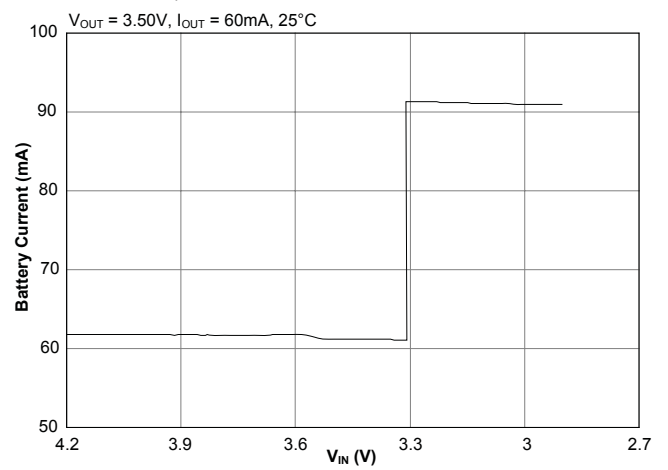

Backlight Efficiency (5 LEDs) — 5.0mA Each

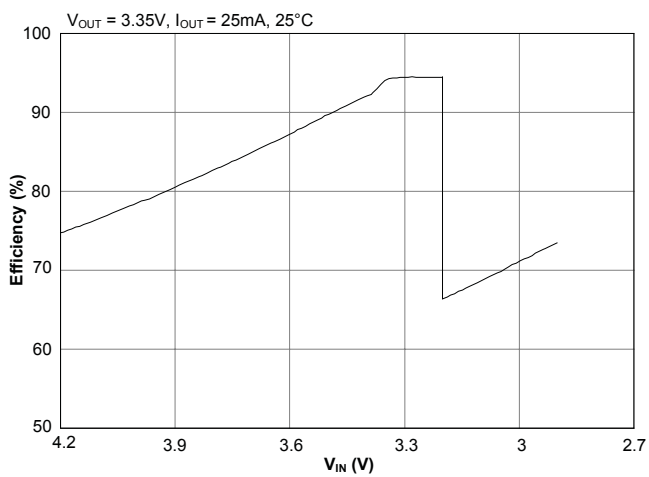

Battery Current (5 LEDs) — 5.0mA Each

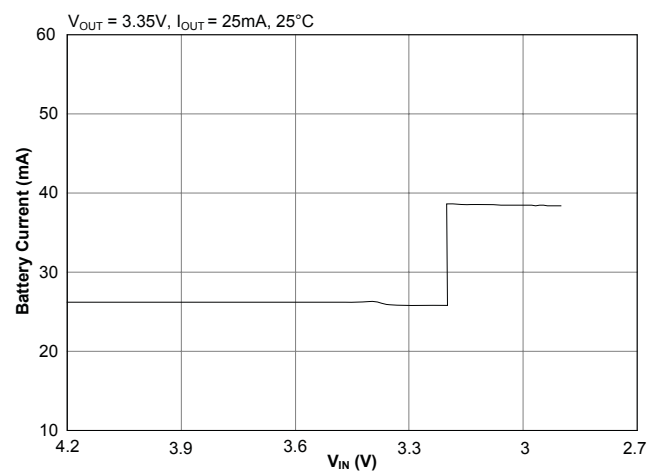

Typical Characteristics (continued)

Ripple — 1X Mode

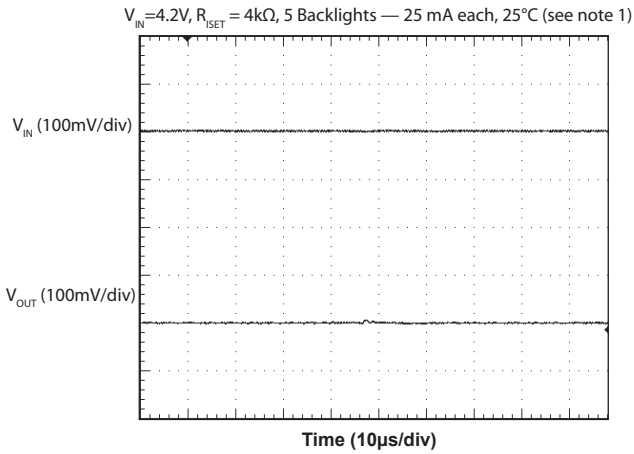

Ripple — 1X Mode

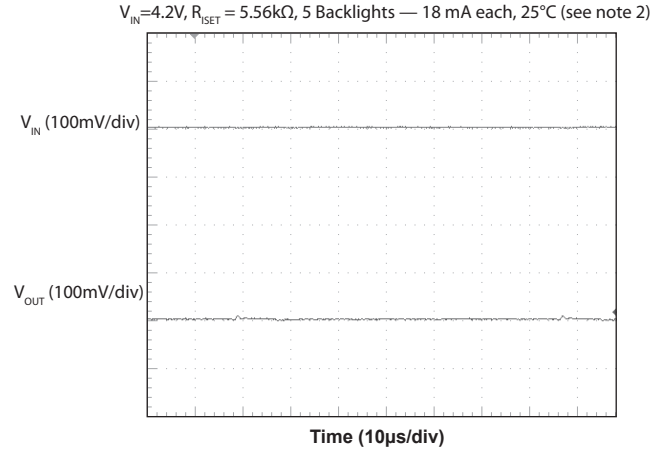

Ripple — 1.5X Mode

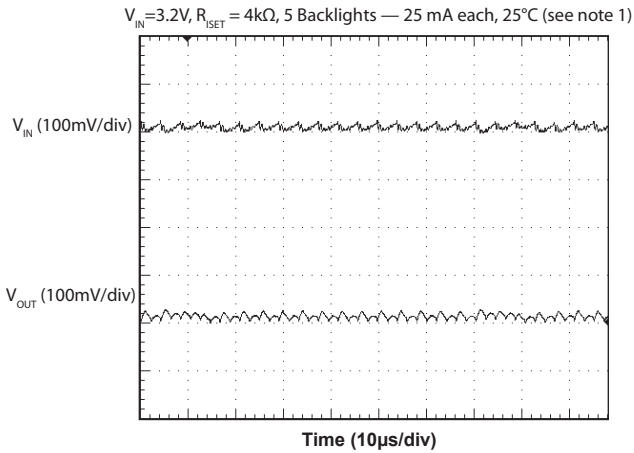

Ripple — 1.5X Mode

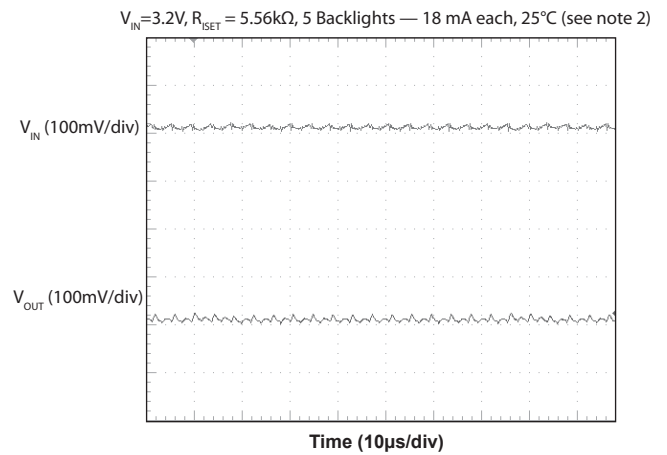

Ripple — 2X Mode

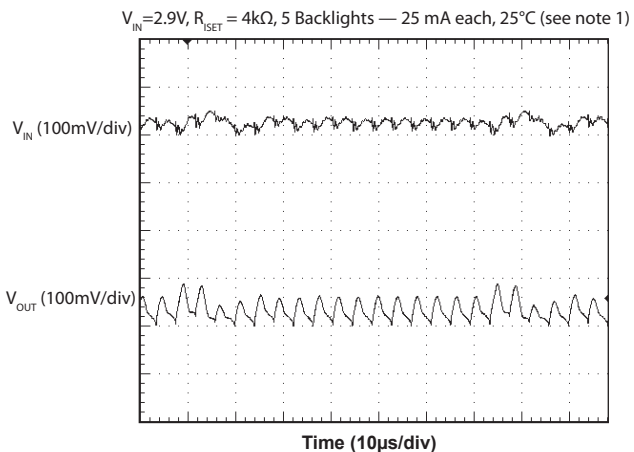

Ripple — 2X Mode

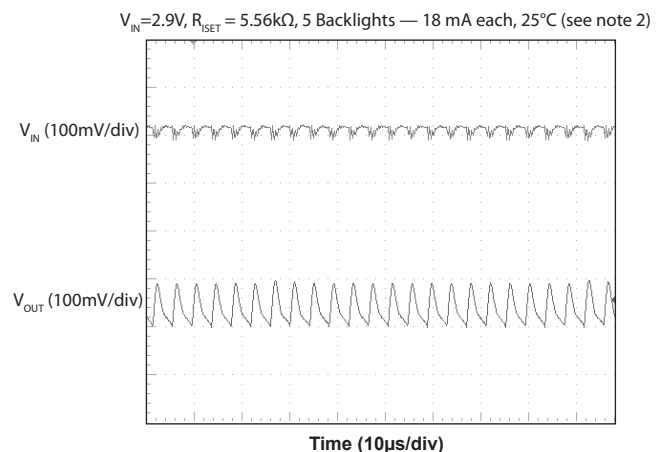

NOTE 1:  $C_{IN}=C_{OUT}=4.7\mu F$  — 0603 size (1608 metric);  $C_1=C_2=2.2\mu F$  — 0402 size (1005 metric)

NOTE 2:  $C_{IN}=C_{OUT}=C_1=C_2=2.2\mu F$  — 0603 size (1608 metric)

Typical Characteristics (continued)

PWM Accuracy — 4.2V

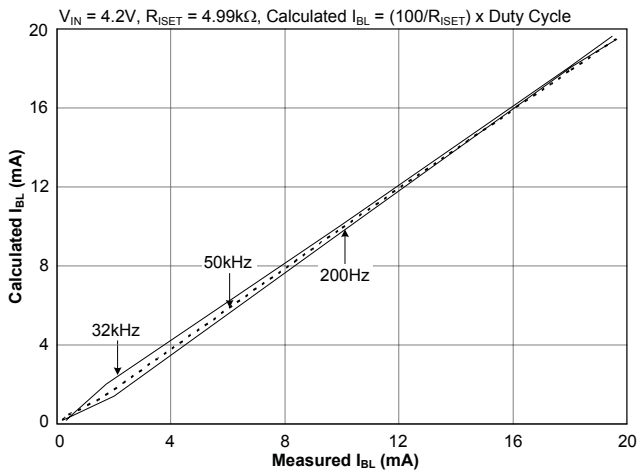

Percentage of Maximum  $I_{BL}$  — 4.2V

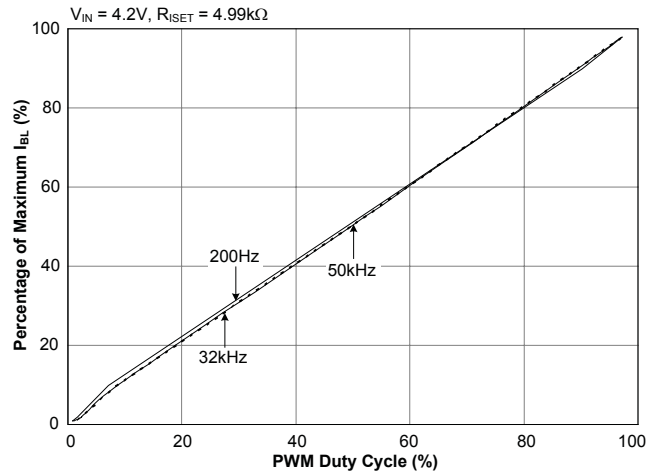

PWM Accuracy — 3.7V

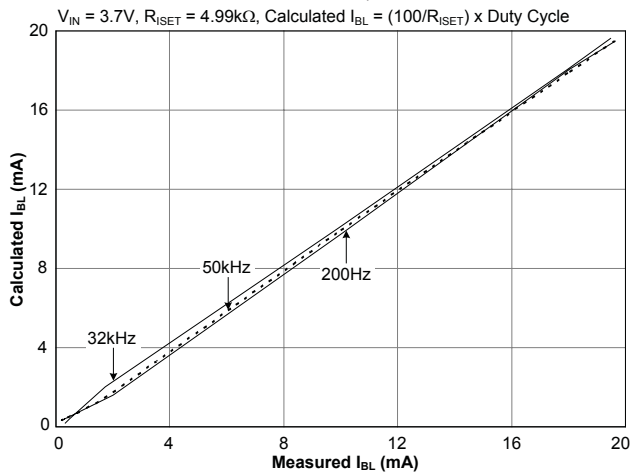

Percentage of Maximum  $I_{BL}$  — 3.7V

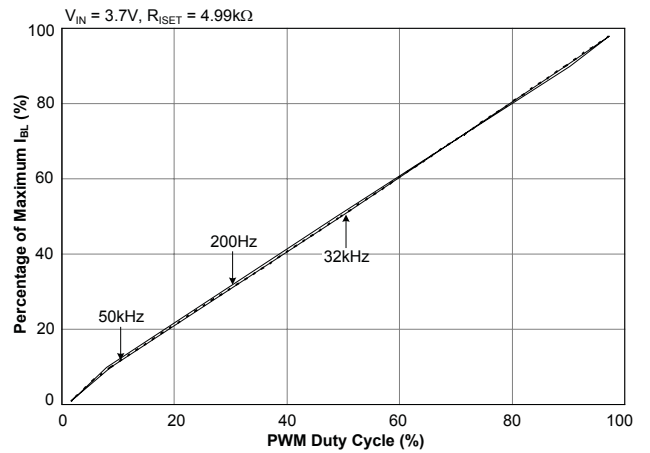

PWM Accuracy — 2.9V

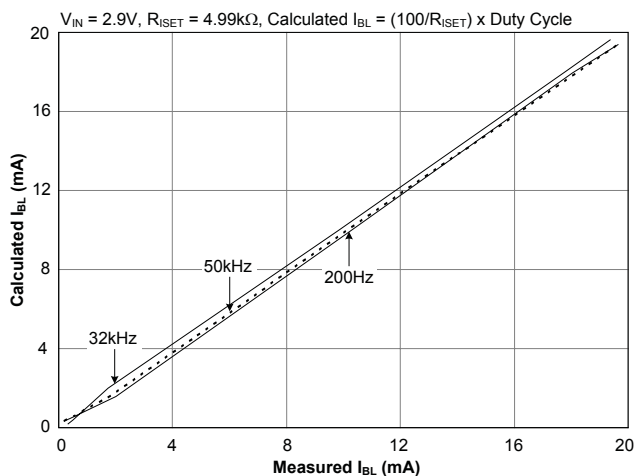

Percentage of Maximum  $I_{BL}$  — 2.9V

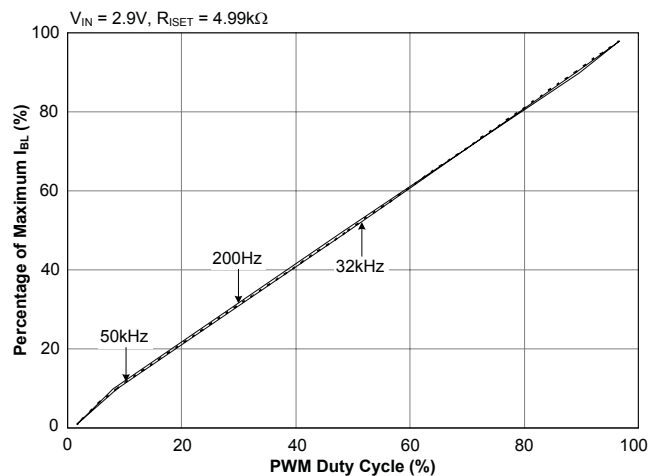



Typical Characteristics (continued)

Start-up — 0% to 50%

$V_{IN} = 3.7V$ , 0 to 50% duty cycle,  $R_{ISET} = 4.99k\Omega$ ,  $f_{PWM} = 32kHz$

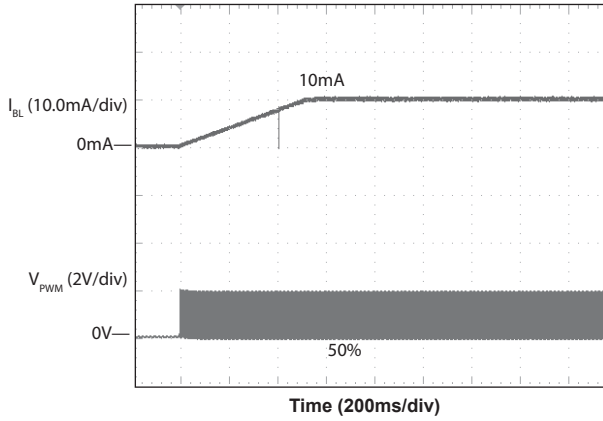

Start-up — 0% to 100%

$V_{IN} = 3.7V$ , 0 to 100% duty cycle,  $R_{ISET} = 4.99k\Omega$ , no PWM

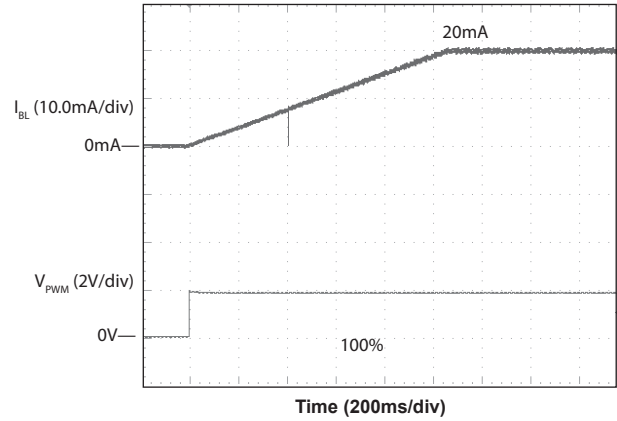

$I_{BL}$  Settling Time — 50% to 100%

$V_{IN} = 3.7V$ ,  $R_{ISET} = 4.99k\Omega$ ,  $f_{PWM} = 32kHz$

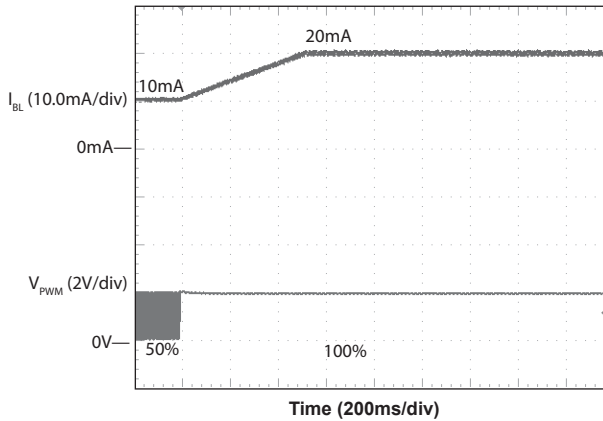

$I_{BL}$  Settling Time — 100% to 50%

$V_{IN} = 3.7V$ ,  $R_{ISET} = 4.99k\Omega$ ,  $f_{PWM} = 32kHz$

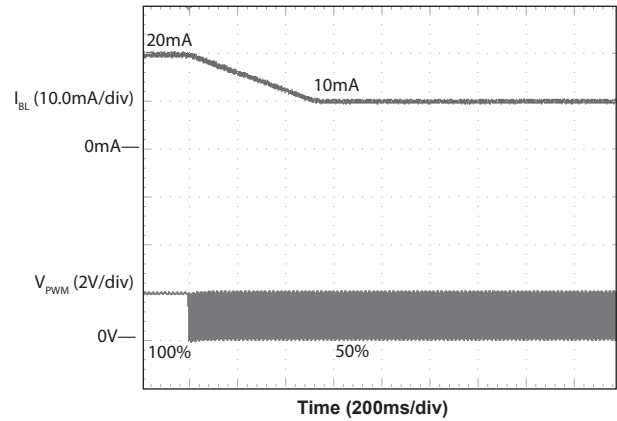

DC Backlight Current — 32kHz PWM

$V_{IN} = 3.7V$ , 50% duty cycle,  $R_{ISET} = 4.99k\Omega$ ,  $I_{BL} = 10mA$

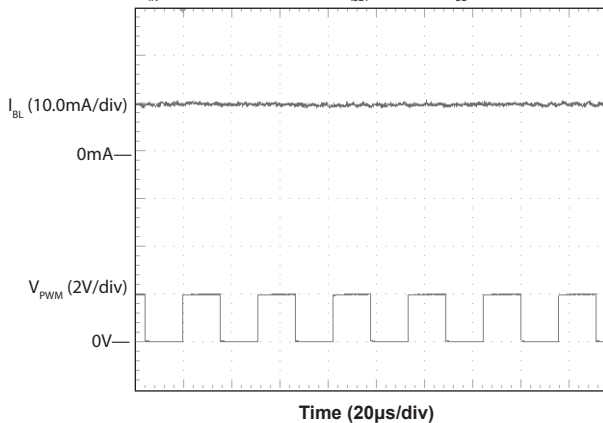

DC Backlight Current — 200Hz PWM

$V_{IN} = 3.7V$ , 50% duty cycle,  $R_{ISET} = 4.99k\Omega$ ,  $I_{BL} = 10mA$

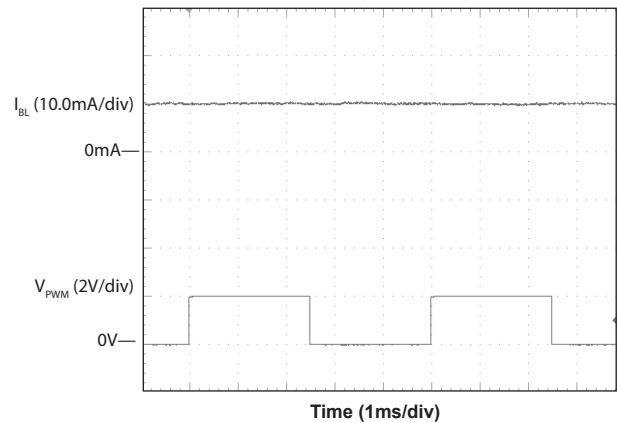

## Pin Descriptions

Pin #	Pin Name	Pin Function
1	OUT	Charge pump output — all LED anode pins should be connected to this pin
2	IN	Battery voltage input
3	ISET	Current setting pin — connect a resistor between this pin and the IN pin to set the LED current
4	EN/PWM	Enable pin — also used as the PWM input for dimming control
5	BL5	Current sink output for main backlight LED 5 — leave this pin open if unused
6	BL4	Current sink output for main backlight LED 4 — leave this pin open if unused
7	BL3	Current sink output for main backlight LED 3 — leave this pin open if unused
8	BL2	Current sink output for main backlight LED 2 — leave this pin open if unused
9	BL1	Current sink output for main backlight LED 1 — leave this pin open if unused
10	GND	Ground pin
11	C2-	Negative connection to bucket capacitor 2
12	C1-	Negative connection to bucket capacitor 1
13	C1+	Positive connection to bucket capacitor 1
14	C2+	Positive connection to bucket capacitor 2

Block Diagram

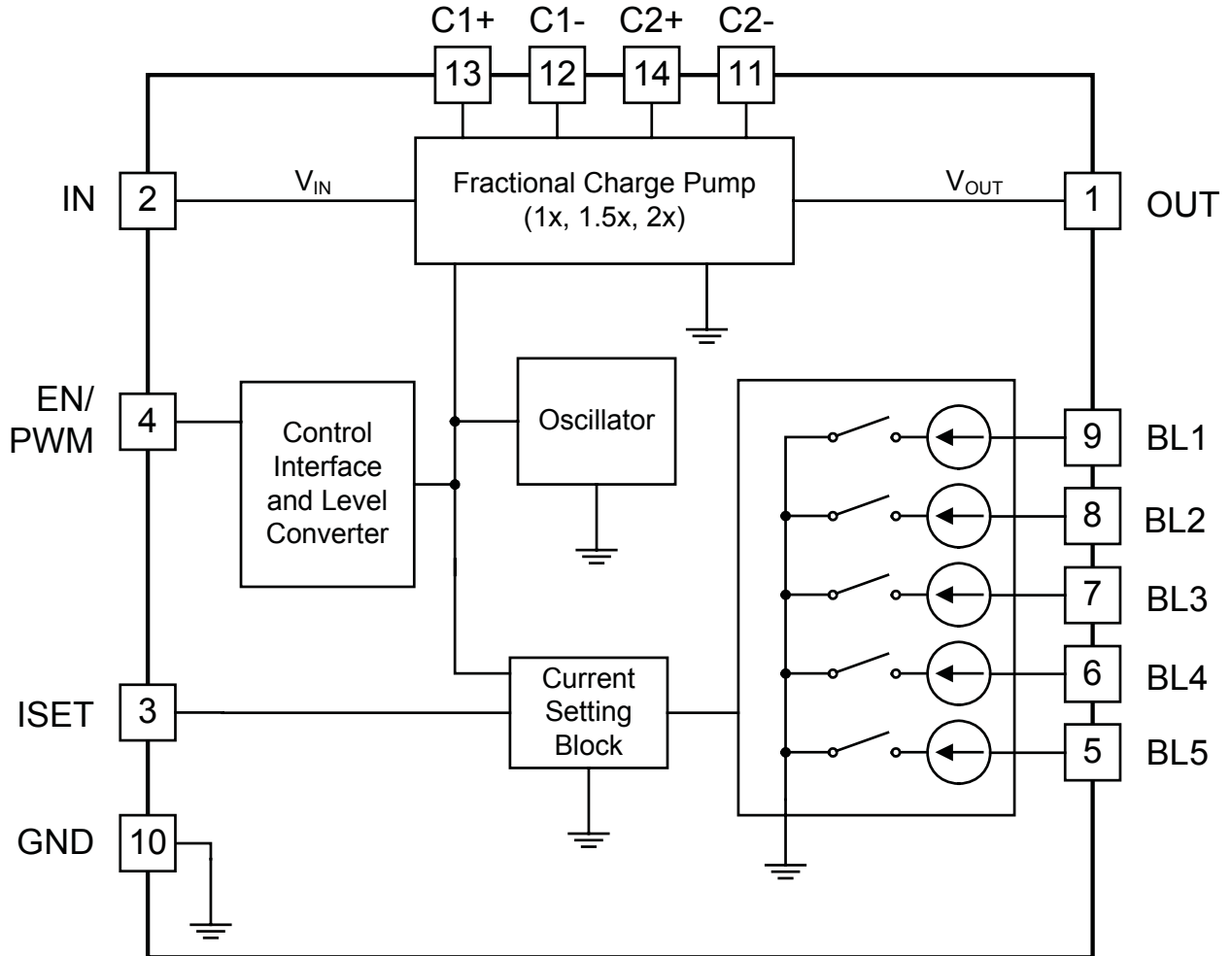

## Applications Information

### General Description

This design is optimized for handheld applications supplied from a single Li-Ion cell and includes the following key features:

- A high efficiency fractional charge pump that supplies power to all LEDs
- Five matched current sinks that control LED backlighting current, providing 500 $\mu$ A to 25mA per LED
- EN/PWM pin functions as an enable and provides PWM control of the LED brightness

### High Current Fractional Charge Pump

The backlight outputs are supported by a high efficiency, high current fractional charge pump output. The charge pump multiplies the input voltage by 1, 1.5, or 2 times. The charge pump switches at a fixed frequency of 250kHz in 1.5x and 2x modes and is disabled in 1x mode to save power and improve efficiency.

The mode selection circuit automatically selects the mode as 1x, 1.5x, or 2x based on circuit conditions such as LED voltage, input voltage, and load current. The 1x mode is the most efficient of the three modes, followed by 1.5x and 2x modes. Circuit conditions such as low input voltage, high output current, or high LED voltage place a higher demand on the charge pump output. A higher numerical mode (1.5x or 2x) may be needed momentarily to maintain regulation at the OUT pin during intervals of high demand. The charge pump responds to momentary high demands, setting the charge pump to the optimum mode to deliver the output voltage and load current while optimizing efficiency. Hysteresis is provided to prevent mode toggling.

The charge pump requires two bucket capacitors for proper operation. One capacitor must be connected between the C1+ and C1- pins and the other must be connected between the C2+ and C2- pins as shown in the Typical Application Circuit diagram. These capacitors should be equal in value, with a minimum capacitance of 1 $\mu$ F to support the charge pump current requirements. The device also requires at least 1 $\mu$ F capacitance on the IN pin and at least 1 $\mu$ F capacitance on the OUT pin to mini-

mize noise and support the output drive requirements of  $I_{OUT}$  up to 90mA. For output currents higher than 90mA, a nominal value of 4.7 $\mu$ F is recommended for  $C_{OUT}$  and  $C_{IN}$ .

Capacitors with X7R or X5R ceramic dielectric are strongly recommended for their low ESR and superior temperature and voltage characteristics. Y5V capacitors should not be used as their temperature coefficients make them unsuitable for this application.

It is important that the minimum value of the capacitors used is no lower than 1 $\mu$ F. This may require the use of 2.2 $\mu$ F capacitors to be sure that the degradation of capacitance due to DC voltage does not cause the capacitance to go below 1 $\mu$ F.

### LED Backlight Current Sinks

The full scale backlight current ( $I_{FS\_BL}$ ) is set via the current through the ISET pin ( $I_{ISET}$ ).  $I_{FS\_BL}$  is regulated to the value of  $I_{ISET}$  multiplied by an internal gain of 100A/A.  $R_{ISET}$  is used to control the current through the ISET pin. The relationship between  $R_{ISET}$  and the full scale backlight current is:

$$R_{ISET} = 100/I_{FS\_BL}$$

All backlight current sinks have matched currents, even when there is a variation in the forward voltages ( $\Delta V_F$ ) of the LEDs. A  $\Delta V_F$  of 1.0V is supported when the input voltage is at 2.9V. Higher  $\Delta V_F$  LED mis-match is supported when  $V_{IN}$  is higher than 2.9V. All current sink outputs are compared and the lowest output is used for setting the voltage regulation at the OUT pin. This is done to ensure that sufficient bias exists for all LEDs.

Any unused outputs must be left open and unused LED drivers will remain disabled.

### PWM Operation

A PWM signal can be used to adjust the DC current through the LEDs. When the duty cycle is 100%, the backlight current through each LED ( $I_{BL}$ ) equals the full scale current set by  $R_{ISET}$ . As the duty cycle decreases, the EN/PWM input samples the control signal and converts the duty cycle to a DC current level. In conventional PWM controlled systems, the output current pulses on and off with the PWM input to achieve an effective

## Applications Information (continued)

average current. Providing a DC current through the LEDs instead of a pulsed current provides an efficiency advantage over other PWM controlled systems by allowing the charge pump to remain in 1x mode longer because the maximum current is equal to the average current.

### PWM Sampling

The sampling system that translates the PWM signal to a DC current requires the EN/PWM pin to have a minimum high time  $t_{\text{HIGH\_MIN}}$  to set the DC level. High time less than  $t_{\text{HIGH\_MIN}}$  impacts the accuracy of the target  $I_{\text{BL}}$ . The minimum duty cycle needed to support the minimum high time specification varies with the applied PWM frequency (see figure 1). Note that use of a lower PWM frequency, from 200Hz to 10kHz, will support lower minimum duty cycle and an extended backlight dimming range.

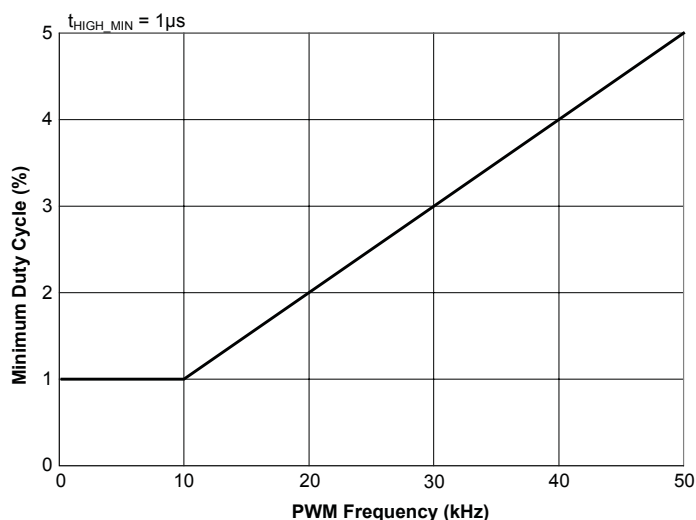

Figure 1 — Minimum Duty Cycle

### Shutdown Mode

The device is disabled when the EN/PWM pin is held low for 7ms or longer.

### Protection Features

The SC652 provides several protection features to safeguard the device from catastrophic failures. These features include:

- Output Open Circuit Protection
- Over-Temperature Protection

- Charge Pump Output Current Limit
- LED Float Detection

### Output Open Circuit Protection

Over-Voltage Protection (OVP) at the OUT pin prevents the charge pump from producing an excessively high output voltage. In the event of an open circuit between the OUT pin and all current sinks (no loads connected), the charge pump runs in open loop and the voltage rises up to the OVP limit. OVP operation is hysteretic, meaning the charge pump will momentarily turn off until  $V_{\text{OUT}}$  is sufficiently reduced. The maximum OVP threshold is 6.0V, allowing the use of a ceramic output capacitor rated at 6.3V.

### Over-Temperature Protection

The Over-Temperature (OT) protection circuit prevents the device from overheating and experiencing a catastrophic failure. When the junction temperature exceeds 165°C, the device goes into thermal shutdown with all outputs disabled until the junction temperature is reduced. All register information is retained during thermal shutdown. Hysteresis of 20°C is provided to ensure that the device cools sufficiently before re-enabling.

### Charge Pump Output Current Limit

The device limits the charge pump current at the OUT pin. If the OUT pin is shorted to ground, or  $V_{\text{OUT}}$  is lower than 2.5V, the typical output current limit is 45mA. The typical output current is limited to 400mA when overloaded resistively with  $V_{\text{OUT}}$  greater than 2.5V.

### LED Float Detection

Float detect is a fault detection feature of the LED backlight outputs. If an output is programmed to be enabled and an open circuit fault occurs at any backlight output, that output will be disabled to prevent a sustained output OVP condition from occurring due to the resulting open loop. Float detect ensures device protection but does not ensure optimum performance.

## Applications Information (continued)

### PCB Layout Considerations

The layout diagram in Figure 2 illustrates a proper two layer PCB layout for the SC652 and supporting components. Following fundamental layout rules is critical for achieving the performance specified in the Electrical Characteristics table. The following guidelines are recommended when developing a PCB layout:

- Place all bucket and decoupling capacitors —  $C_1$ ,  $C_2$ ,  $C_{IN}$ , and  $C_{OUT}$  — as close to the device as possible.
- All charge pump current passes through pins IN, OUT,  $C_{1+}$ ,  $C_{2+}$ ,  $C_{1-}$ , and  $C_{2-}$ . Therefore, ensure that all connections to these pins make use of wide traces so that the voltage drop on each connection is minimized.
- The GND pin should be connected to a ground plane using multiple vias to ensure proper thermal connection for optimal heat transfer.
- Make solid ground connections between the grounds of the  $C_{OUT}$ ,  $C_{IN}$ , and the GND pin on the device.
- Resistor  $R_{SET}$  should be connected as shown in Figure 2, close to pins IN and ISET. The placement and routing shown minimizes parasitic capacitance at the ISET pin.

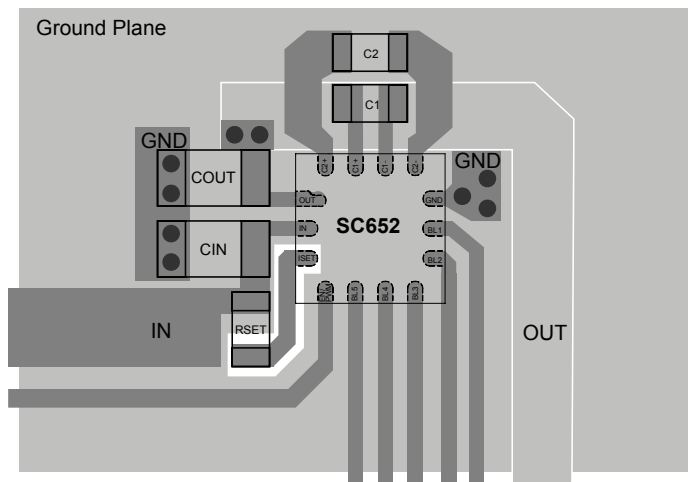

Figure 2 — Recommended PCB Layout

- Figure 4 shows layer 2, and has only two net connections, GND and OUT. Note that OUT is routed around the GND pin, and does not interfere with the ground connections between  $C_{IN}$ ,  $C_{OUT}$  and the GND pin. Also, layer 2 has a blank void in the copper beneath the ISET trace. The blank space reduces the capacitance coupled to the ISET pin.

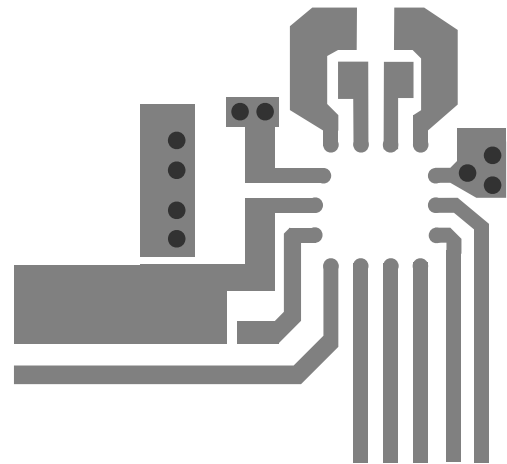

Figure 3 — Layer 1

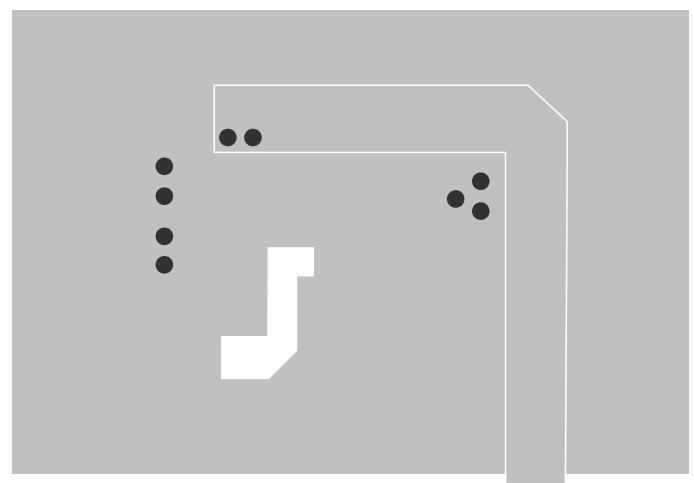
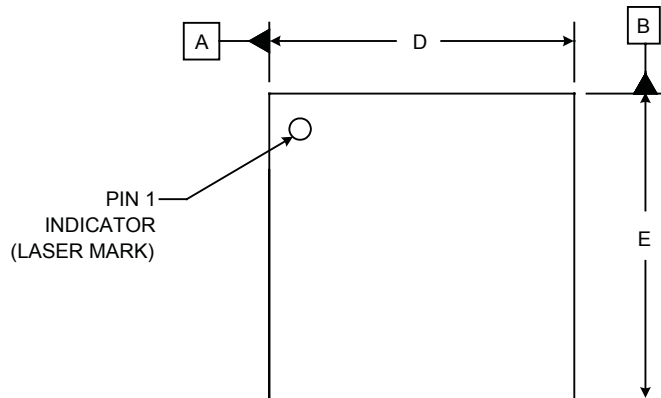

Figure 4 — Layer 2

- Figure 3 shows the pads on layer 1 that should be connected with vias to layer 2.  $C_{IN}$ ,  $C_{OUT}$  and the GND pin all use vias to connect to the ground plane. The OUT pin also uses vias and routes on layer 2.

Outline Drawing — MLPQ-UT-14 2x2



DIM	INCHES			MILLIMETERS		
	MIN	NOM	MAX	MIN	NOM	MAX
A	.020	-	.024	0.50	-	0.60
A1	.000	-	.002	0.00	-	0.05
A2	(.006)			(0.152)		
b	.006	.008	.010	0.15	0.20	0.25
D	.077	.079	.081	1.95	2.00	2.05
E	.077	.079	.081	1.95	2.00	2.05
e	.016 BSC			0.40 BSC		
L	.010	.012	.014	0.25	0.30	0.35
L1	.014	.016	.018	0.35	0.40	0.45
N	14			14		
aaa	.003			0.08		
bbb	.004			0.10		

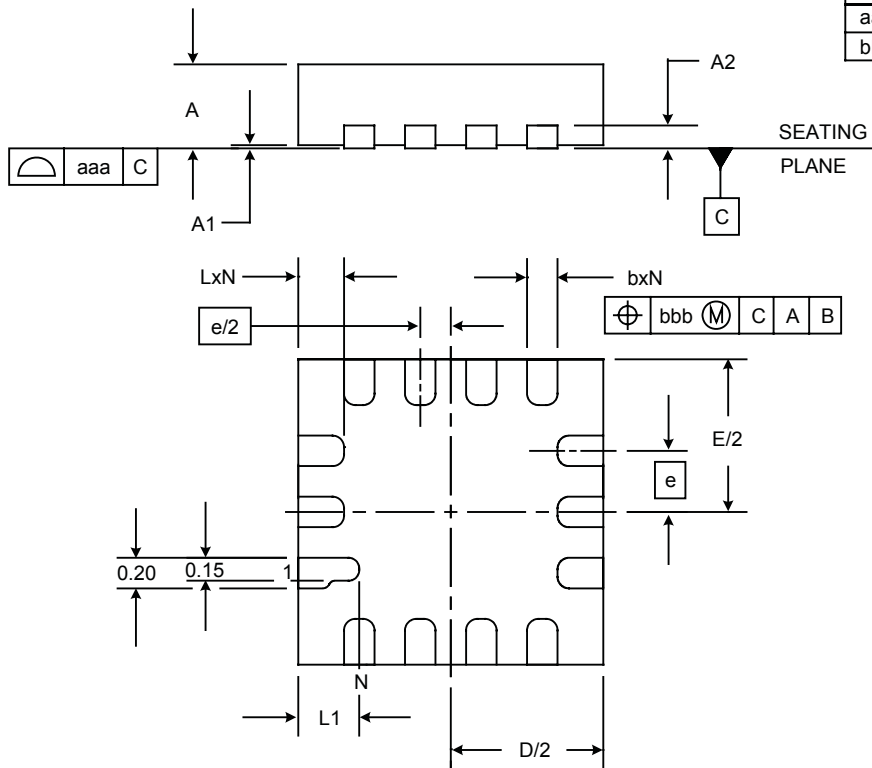

NOTES:

1. CONTROLLING DIMENSIONS ARE IN MILLIMETERS (ANGLES IN DEGREES).

**Land Pattern — MLPQ-UT-14 2x2**

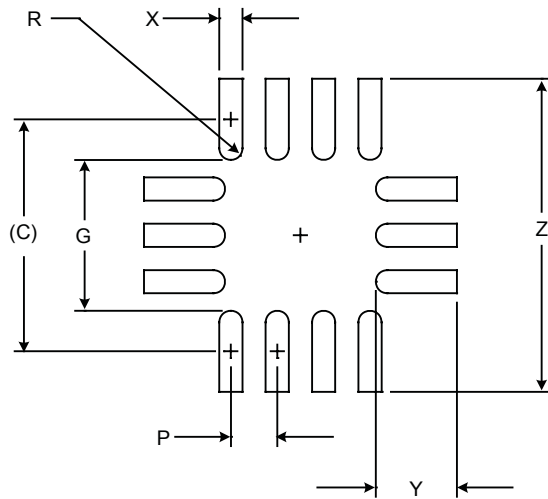

DIMENSIONS		
DIM	INCHES	MILLIMETERS
C	(.079)	(2.00)
G	.055	1.40
P	.016	0.40
R	.004	0.10
X	.008	0.20
Y	.024	0.60
Z	.102	2.60

**NOTES:**

1. CONTROLLING DIMENSIONS ARE IN MILLIMETERS (ANGLES IN DEGREES).
2. THIS LAND PATTERN IS FOR REFERENCE PURPOSES ONLY. CONSULT YOUR MANUFACTURING GROUP TO ENSURE YOUR COMPANY'S MANUFACTURING GUIDELINES ARE MET.
3. SQUARE PACKAGE - DIMENSIONS APPLY IN BOTH " X " AND " Y " DIRECTIONS.
4. PIN 1 PAD CAN BE SHORTER THAN THE ACTUAL PACKAGE LEAD TO AVOID SOLDER BRIDGING BETWEEN PINS 1 & 14.

**Contact Information**

Semtech Corporation  
 Power Management Products Division  
 200 Flynn Road, Camarillo, CA 93012  
 Phone: (805) 498-2111 Fax: (805) 498-3804

[www.semtech.com](http://www.semtech.com)



Компания «Life Electronics» занимается поставками электронных компонентов импортного и отечественного производства от производителей и со складов крупных дистрибьюторов Европы, Америки и Азии.

С конца 2013 года компания активно расширяет линейку поставок компонентов по направлению коаксиальный кабель, кварцевые генераторы и конденсаторы (керамические, пленочные, электролитические), за счёт заключения дистрибьюторских договоров

Мы предлагаем:

- Конкурентоспособные цены и скидки постоянным клиентам.
- Специальные условия для постоянных клиентов.
- Подбор аналогов.
- Поставку компонентов в любых объемах, удовлетворяющих вашим потребностям.
- Приемлемые сроки поставки, возможна ускоренная поставка.
- Доставку товара в любую точку России и стран СНГ.
- Комплексную поставку.
- Работу по проектам и поставку образцов.
- Формирование склада под заказчика.
- Сертификаты соответствия на поставляемую продукцию (по желанию клиента).
- Тестирование поставляемой продукции.
- Поставку компонентов, требующих военную и космическую приемку.
- Входной контроль качества.
- Наличие сертификата ISO.

В составе нашей компании организован Конструкторский отдел, призванный помогать разработчикам, и инженерам.

Конструкторский отдел помогает осуществить:

- Регистрацию проекта у производителя компонентов.
- Техническую поддержку проекта.
- Защиту от снятия компонента с производства.
- Оценку стоимости проекта по компонентам.
- Изготовление тестовой платы монтаж и пусконаладочные работы.



Тел: +7 (812) 336 43 04 (многоканальный)

Email: [org@lifeelectronics.ru](mailto:org@lifeelectronics.ru)