

1.2 A Slew Rate Controlled Load Switch in PPAK SC75-6, and TDFN4 1.2 mm x 1.6 mm

DESCRIPTION

The SiP4282 series is a slew rate controlled high side switch. The switch is of a low ON resistance P-Channel MOSFET that supports continuous current up to 1.2 A.

The SiP4282 series operates with an input voltage from 1.8 V to 5.5 V. It offers under voltage lock out that turns the switch off when an input under voltage condition exists. The "A" option without UVLO extends the minimum operation voltage from 1.8 V down to 1.5 V. The SiP4282 is available in two different versions of slew rates, 100 μ s and 1 ms. The SiP4282 series integrates load discharge circuit to ensure the discharge of capacitive load when the switch is disabled. The SiP4282 features low input logic level to interface with low control voltage from microprocessors. This device has a very low operating current (typically 2.5 μ A for SiP4282 and 50 pA for SiP4282A).

The SiP4282 is available in lead (Pb)-free package options including 6 pin PPAK SC75-6, and 4 pin TDFN4 1.2 mm x 1.6 mm DFN4 packages. The operation temperature range is specified from - 40 $^{\circ}$ C to + 85 $^{\circ}$ C.

The SiP4282 compact package options, operation voltage range, and low operating current make it a good fit for battery power applications.

FEATURES

- 1.8 V to 5.5 V input voltage range for SiP4282
- 1.5 V to 5.5 V input voltage range for SiP4282A
- Very low $R_{DS(ON)}$, typically 105 m Ω at 5 V and 175 m Ω at 3 V
- Slew rate controlled turn-on time options: 100 μ s, and 1 ms
- Fast shutdown load discharge
- Low quiescent current, 4 μ A for SiP4282
- Low quiescent current, 1 μ A for SiP4282A
- Low shutdown current < 1 μ A
- UVLO of 1.4 V for SiP4282
- PowerPAK SC-75 1.6 mm x 1.6 mm and TDFN4 1.2 mm x 1.6 mm packages
- Compliant to RoHS directive 2002/95/EC

RoHS
COMPLIANT

APPLICATIONS

- Cellular telephones
- Digital still cameras
- Personal digital assistants (PDA)
- Hot swap supplies
- Notebook computers
- Personal communication devices
- Portable Instruments

TYPICAL APPLICATION CIRCUIT

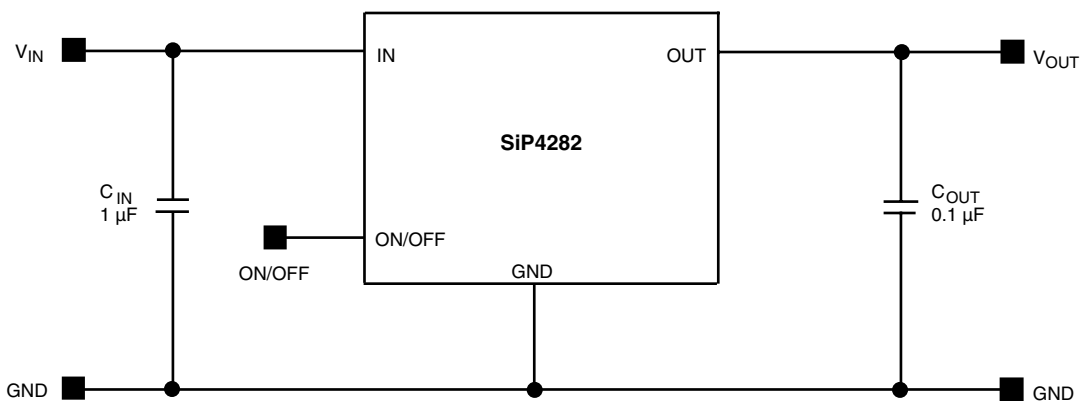

Figure 1 - SiP4282 Typical Application Circuit

ORDERING INFORMATION

| Temperature Range | Package | Slew Rate (typ.) | Under Voltage Lockout | Marking | Part Number |
|-------------------|-----------------|------------------|-----------------------|---------|--------------------|
| - 40 °C to 85 °C | PPAK SC75-6 | 1 ms | No | LDxxx | SiP4282ADVP2-T1GE3 |
| | | 100 μs | No | LExxx | SiP4282ADVP3-T1GE3 |
| | | 100 μs | Yes | LFxxx | SiP4282DVP3-T1GE3 |
| | TDFN4 1.2 x 1.6 | 1 ms | No | AAx | SiP4282ADNP2-T1GE4 |
| | | 100 μs | No | ABx | SiP4282ADNP3-T1GE4 |
| | | 100 μs | Yes | ACx | SiP4282DNP3-T1GE4 |

Notes:

xxx = Lot Code

ABSOLUTE MAXIMUM RATINGS

| Parameter | Limit | Unit | |
|---|--|------|------|
| Supply Input Voltage (V_{IN}) | - 0.3 to 6 | V | |
| Enable Input Voltage ($V_{ON/OFF}$) | - 0.3 to 6 | | |
| Output Voltage (V_{OUT}) | - 0.3 to $V_{IN} + 0.3$ | | |
| Maximum Continuous Switch Current (I_{MAX}) | 1.4 | A | |
| Maximum Pulsed Current (I_{DM}) V_{IN} | $V_{IN} \geq 2.5$ V | | 3 |
| | $V_{IN} < 2.5$ V | | 1.6 |
| ESD Rating (HBM) | 4000 | V | |
| Junction Temperature (T_J) | - 40 to 125 | °C | |
| Thermal Resistance (θ_{JA}) ^a | 6 pin PPAK SC75 ^b | 90 | °C/W |
| | 4 pin TDFN4 1.2 mm x 1.6 mm ^c | 170 | |
| Power Dissipation (P_D) ^a | 6 pin PPAK SC75 ^b | 610 | mW |
| | 4 pin TDFN4 1.2 mm x 1.6 mm ^c | 324 | |

Notes:

a. Device mounted with all leads and power pad soldered or welded to PC board.

b. Derate 11.1 mW/°C above $T_A = 70$ °C.c. Derate 5.9 mW/°C above $T_A = 70$ °C, see PCB layout.

Stresses beyond those listed under "Absolute Maximum Ratings" may cause permanent damage to the device. These are stress ratings only, and functional operation of the device at these or any other conditions beyond those indicated in the operational sections of the specifications is not implied. Exposure to absolute maximum rating/conditions for extended periods may affect device reliability.

RECOMMENDED OPERATING RANGE

| Parameter | Limit | Unit |
|---|------------|------|
| Input Voltage Range (V_{IN}) for SiP4282 Version | 1.8 to 5.5 | V |
| Input Voltage Range (V_{IN}) for SiP4282A Version | 1.5 to 5.5 | V |
| Operating Temperature Range | - 40 to 85 | °C |

| SPECIFICATIONS | | | | | | |
|--|-----------------|---|--|-------------------|-------------------|-----------------------|
| Parameter | Symbol | Test Conditions Unless Specified $V_{IN} = 5.0$, $T_A = -40\text{ }^\circ\text{C}$ to $85\text{ }^\circ\text{C}$ (Typical values are at $T_A = 25\text{ }^\circ\text{C}$) | Limits - $40\text{ }^\circ\text{C}$ to $85\text{ }^\circ\text{C}$ | | | Unit |
| | | | Min. ^a | Typ. ^b | Max. ^a | |
| Operating Voltage ^c | V_{IN} | For SiP4282xxx | 1.8 | - | 5.5 | V |
| Operating Voltage | | For SiP4282Axxx | 1.5 | - | 5.5 | |
| Under Voltage Voltage | V_{UVLO} | For SiP4282xxx, V_{IN} falling | 1.0 | 1.4 | 1.8 | |
| Under Voltage Lockout Hysteresis | $V_{UVLO(hyh)}$ | For SiP4282xxx | - | 250 | - | mV |
| Quiescent Current | I_Q | For SiP4282xxx, On/Off = active | - | 2.5 | 4 | μA |
| | | For SiP4282Axxx, On/Off = active | - | 0.00005 | 1 | |
| On-Resistance | $R_{DS(on)}$ | $V_{IN} = 5\text{ V}$, $I_L = 500\text{ mA}$, $T_A = 25\text{ }^\circ\text{C}$ | - | 105 | 230 | m Ω |
| | | $V_{IN} = 4.2\text{ V}$, $I_L = 500\text{ mA}$, $T_A = 25\text{ }^\circ\text{C}$ | - | 110 | 250 | |
| | | $V_{IN} = 3\text{ V}$, $I_L = 500\text{ mA}$, $T_A = 25\text{ }^\circ\text{C}$ | - | 135 | 290 | |
| | | $V_{IN} = 1.8\text{ V}$, $I_L = 500\text{ mA}$, $T_A = 25\text{ }^\circ\text{C}$ | - | 230 | 480 | |
| | | For SiP4282Axxx, $V_{IN} = 1.5\text{ V}$, $I_L = 500\text{ mA}$, $T_A = 25\text{ }^\circ\text{C}$ | - | 350 | 520 | |
| On-Resistance Temp-Coefficient | TC_{RDS} | | - | 2800 | - | ppm/ $^\circ\text{C}$ |
| On/Off Input Low Voltage ^d | V_{IL} | For SiP4282Axxx, $V_{IN} \geq 1.5\text{ V}$ to $< 1.8\text{ V}$ | - | - | 0.3 | V |
| | | $V_{IN} \geq 1.8\text{ V}$ to $< 2.7\text{ V}$ | - | - | 0.4 | |
| | | $V_{IN} \geq 2.7\text{ V}$ to $\leq 5.5\text{ V}$ | - | - | 0.6 | |
| On/Off Input High Voltage ^d | V_{IH} | $V_{IN} \geq 1.5\text{ V}$ to $< 2.7\text{ V}$ | 1.3 | - | - | V |
| | | $V_{IN} \geq 2.7\text{ V}$ to $< 4.2\text{ V}$ | 1.5 | - | - | |
| | | $V_{IN} \geq 4.2\text{ V}$ to $\leq 5.5\text{ V}$ | 1.8 | - | - | |
| On/Off Input Leakage | I_{SINK} | $V_{On/Off} = 5.5\text{ V}$ | - | - | 1 | μA |
| Output Pull-Down Resistance | R_{PD} | On/Off = Inactive, $T_A = 25\text{ }^\circ\text{C}$ | - | 180 | 250 | Ω |
| SiP4282Axxx2 Versions | | | | | | |
| Output Turn-On Delay Time | $t_{d(on)}$ | $V_{IN} = 5\text{ V}$, $R_{LOAD} = 10\text{ }\Omega$, $T_A = 25\text{ }^\circ\text{C}$ | - | 20 | 40 | μs |
| Output Turn-On Rise Time | $t_{(on)}$ | $V_{IN} = 5\text{ V}$, $R_{LOAD} = 10\text{ }\Omega$, $T_A = 25\text{ }^\circ\text{C}$ | - | 1100 | 1500 | |
| Output Turn-Off Delay Time | $t_{d(off)}$ | $V_{IN} = 5\text{ V}$, $R_{LOAD} = 10\text{ }\Omega$, $T_A = 25\text{ }^\circ\text{C}$ | - | 4 | 10 | |
| SiP4282xxx3 and SiP4282Axxx3 Versions | | | | | | |
| Output Turn-On Delay Time | $t_{d(on)}$ | $V_{IN} = 5\text{ V}$, $R_{LOAD} = 10\text{ }\Omega$, $T_A = 25\text{ }^\circ\text{C}$ | - | 20 | 40 | μs |
| Output Turn-On Rise Time | $t_{(on)}$ | $V_{IN} = 5\text{ V}$, $R_{LOAD} = 10\text{ }\Omega$, $T_A = 25\text{ }^\circ\text{C}$ | - | 140 | 180 | |
| Output Turn-Off Delay Time | $t_{d(off)}$ | $V_{IN} = 5\text{ V}$, $R_{LOAD} = 10\text{ }\Omega$, $T_A = 25\text{ }^\circ\text{C}$ | - | 4 | 10 | |

Notes:

- a) The algebraic convention whereby the most negative value is a minimum and the most positive a maximum.
- b) Typical values are for DESIGN AID ONLY, not guaranteed nor subject to production testing
- c) Part requires minimum start-up of $V_{IN} \geq 2.0\text{ V}$ to ensure operation down to 1.8 V .
- d) For V_{IN} outside this range consult typical ON/OFF threshold curve.

PIN CONFIGURATION

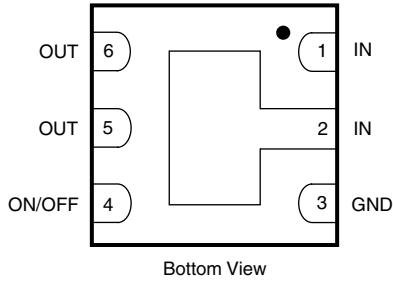

Figure 2 - PPAK SC75-6 Package

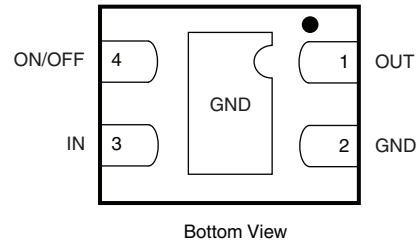

Figure 3 - TDFN4 1.2 mm x 1.6 mm Package

| PIN DESCRIPTION | | | |
|-----------------|-------|--------|--|
| Pin Number | | Name | Function |
| PPAK | TDFN4 | | |
| 1, 2 | 3 | IN | This pin is the p-channel MOSFET source connection. Bypass to ground through a 1 μ F capacitor. |
| 3 | 2 | GND | Ground connection |
| 4 | 4 | ON/OFF | Enable input |
| 5, 6 | 1 | OUT | This pin is the p-channel MOSFET drain connection. Bypass to ground through a 0.1 μ F capacitor. |

TYPICAL CHARACTERISTICS internally regulated, 25 °C, unless otherwise noted

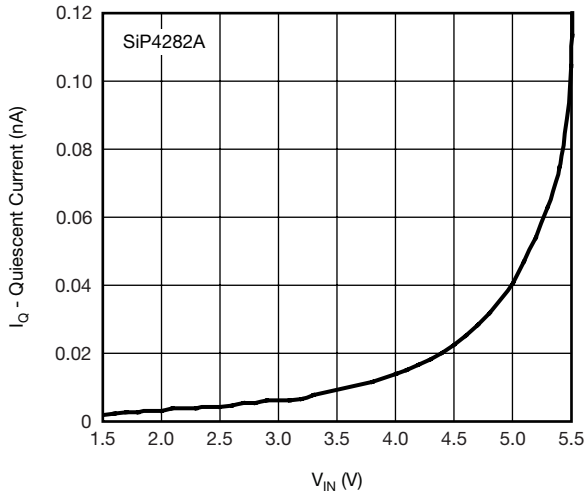

Figure 4 - Quiescent Current vs. Input Voltage

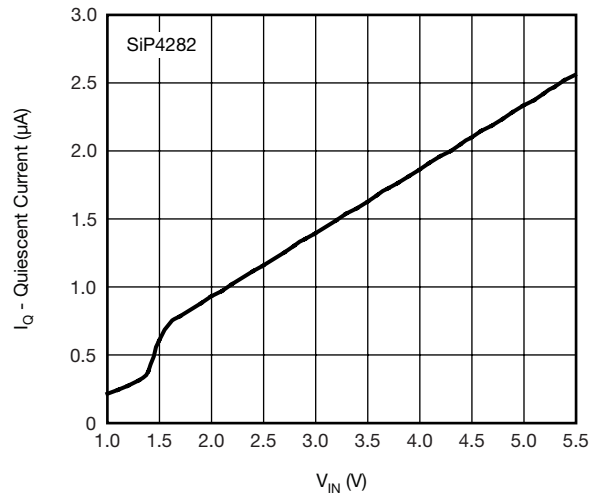

Figure 5 - Quiescent Current vs. Input Voltage

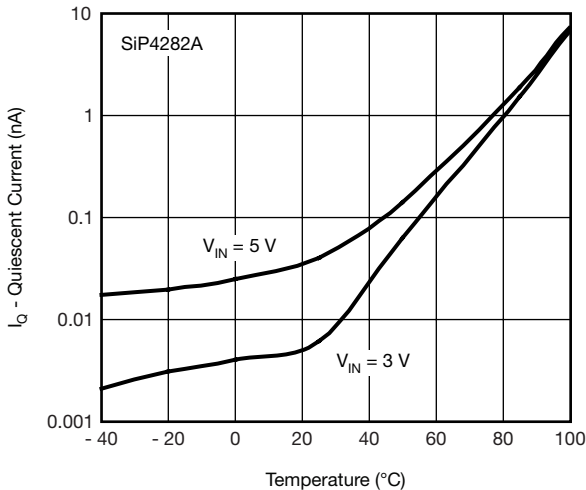

Figure 6 - Quiescent Current vs. Temperature

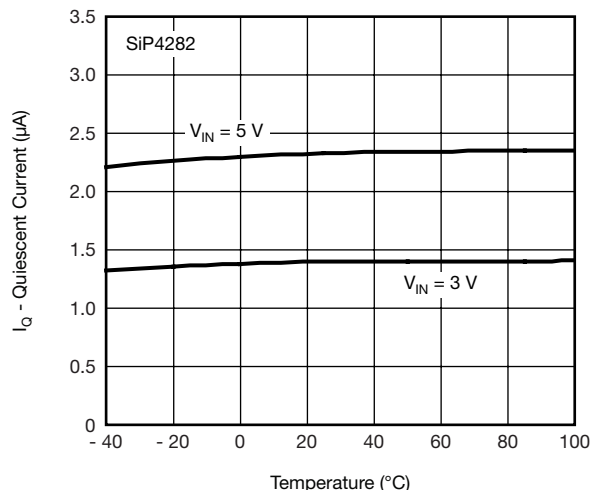

Figure 7 - Quiescent Current vs. Temperature

TYPICAL CHARACTERISTICS internally regulated, 25 °C, unless otherwise noted

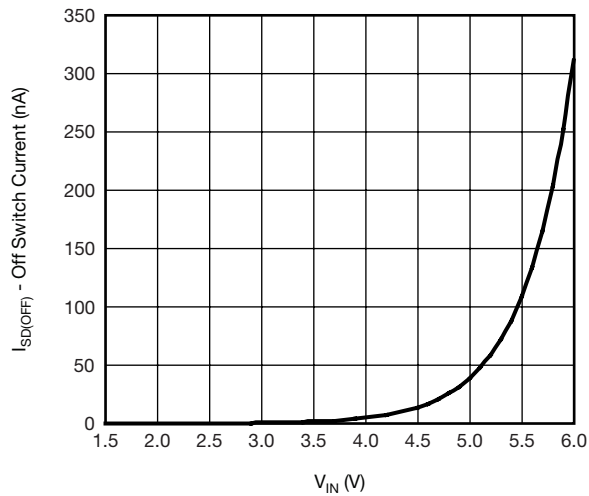

Figure 8 - Off Switch Current vs. Input Voltage

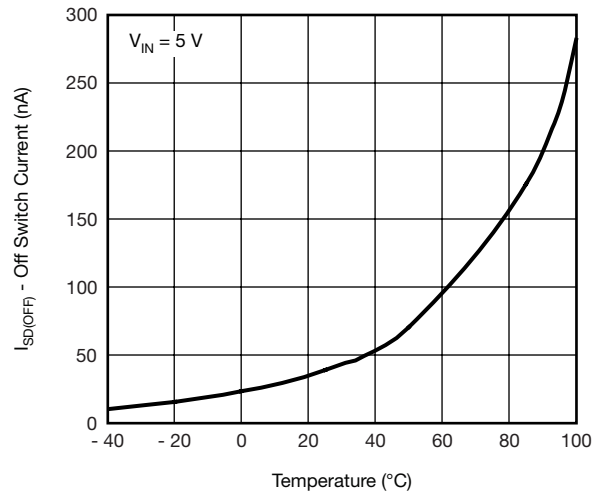

Figure 9 - Off Switch Current vs. Temperature

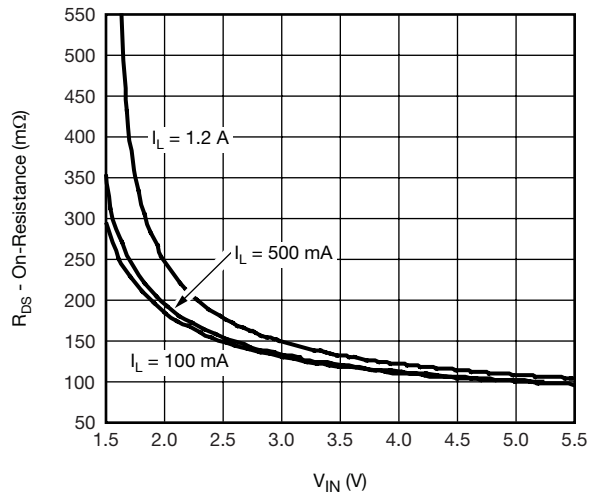

Figure 10 - $R_{DS(ON)}$ vs. Input Voltage

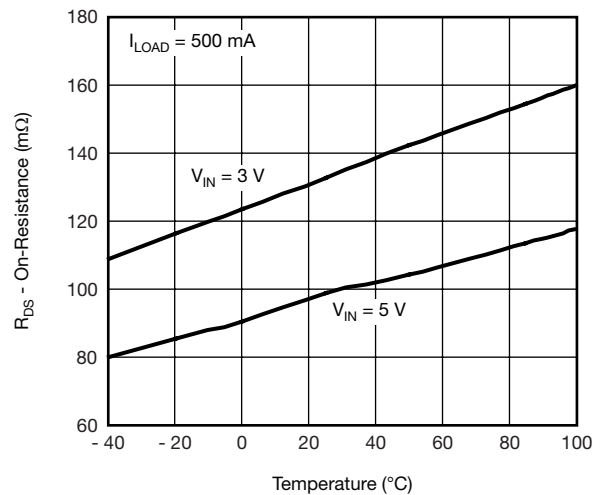

Figure 11 - $R_{DS(ON)}$ vs. Temperature

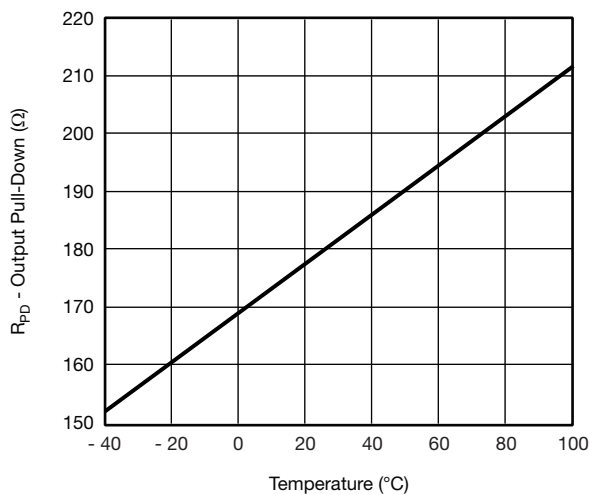

Figure 12 - Output Pull-Down Resistance vs.

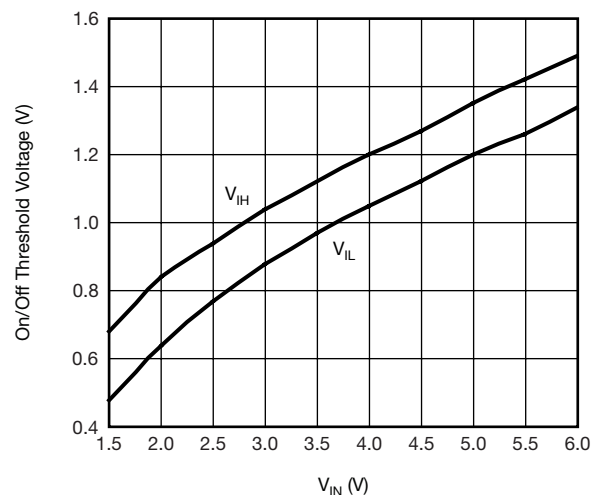

Figure 13 - ON/OFF Threshold vs. Input Voltage

TYPICAL WAVEFORMS

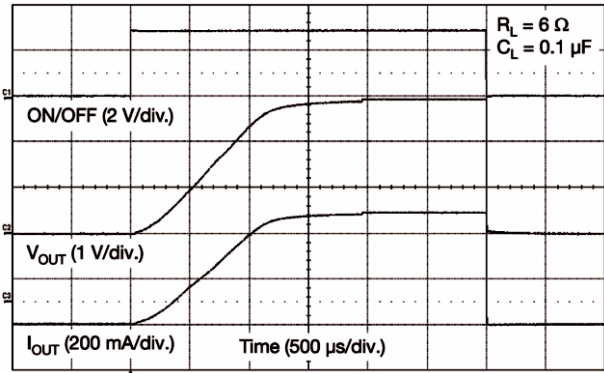

Figure 14 - SiP4282Axxx2 Switching ($V_{IN} = 3\text{ V}$)

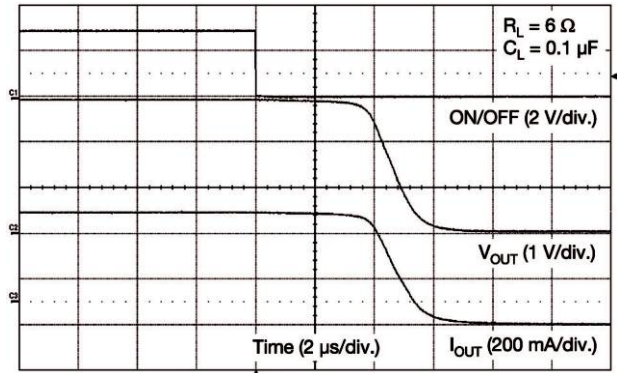

Figure 15 - SiP4282Axxx2 Turn-Off ($V_{IN} = 3\text{ V}$)

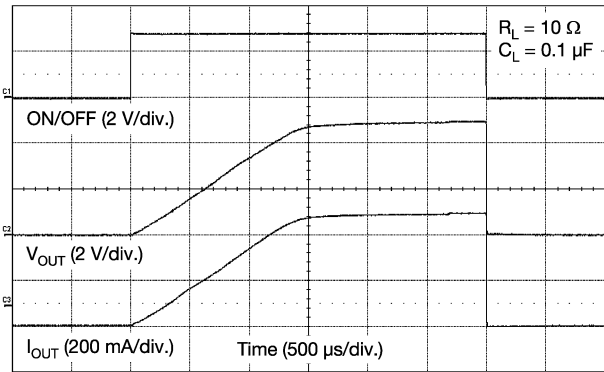

Figure 16 - SiP4282Axxx2 Switching ($V_{IN} = 5\text{ V}$)

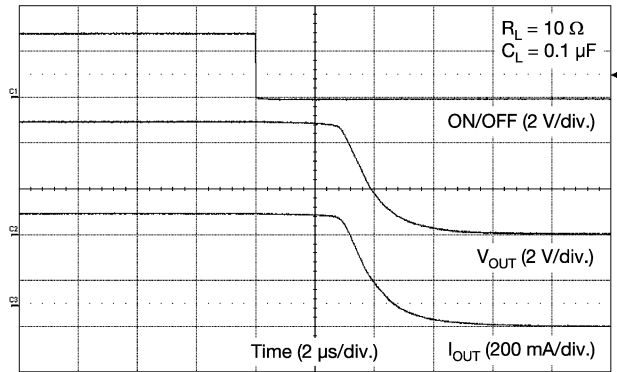

Figure 17 - SiP4282Axxx2 Turn-Off ($V_{IN} = 5\text{ V}$)

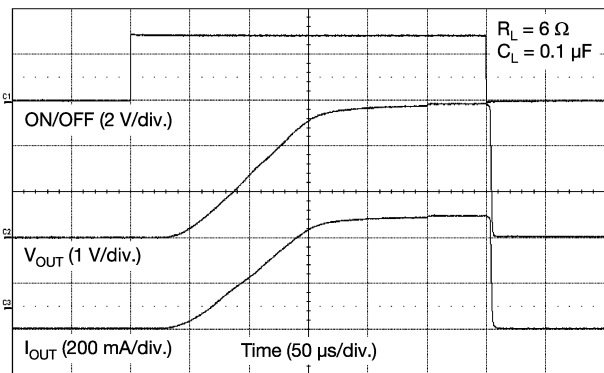

Figure 18 - SiP4282xxx3 and SiP4282Axxx3 Switching ($V_{IN} = 3\text{ V}$)

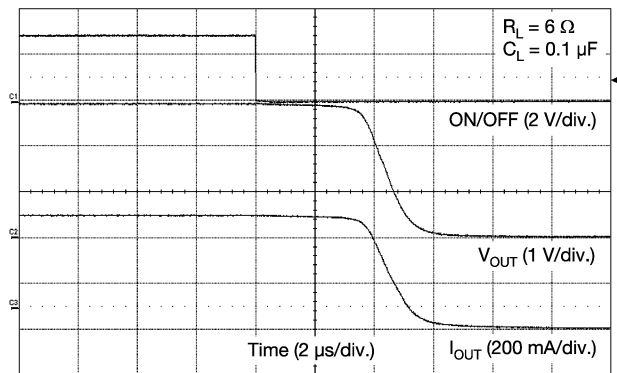

Figure 19 - SiP4282xxx3 and SiP4282Axxx3 Turn-Off ($V_{IN} = 3\text{ V}$)

TYPICAL WAVEFORMS

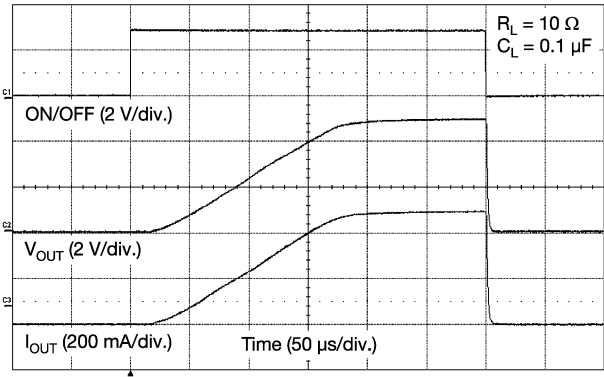

Figure 20 - SiP4282xxx3 and SiP4282Axxx3 Switching ($V_{IN} = 5$)

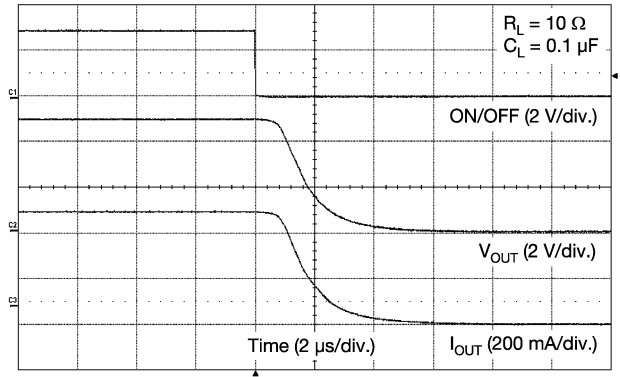

Figure 21 - SiP4282xxx3 and SiP4282Axxx3 Turn-Off ($V_{IN} = 5$)

BLOCK DIAGRAM

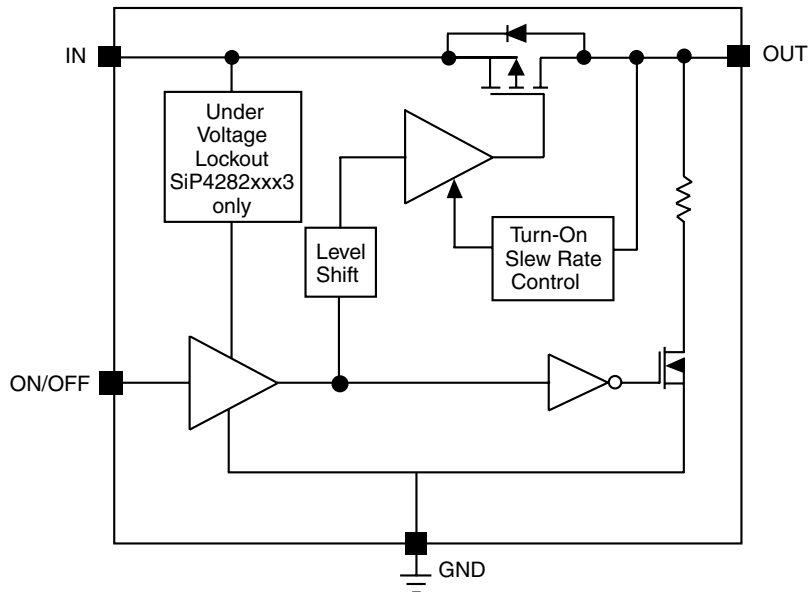

Figure 22 - SiP4282 Functional Block Diagram

PCB LAYOUT

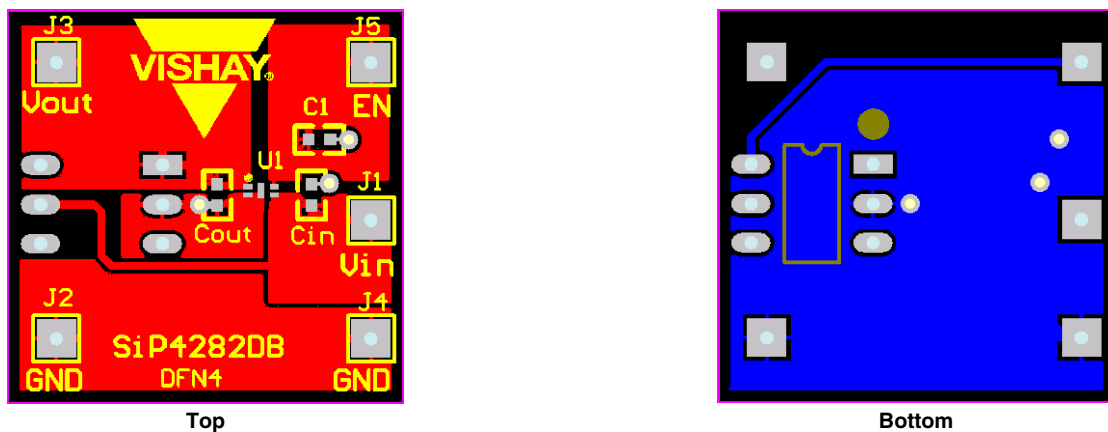

Figure 23 - TDFN4 1.2 mm x 1.6 mm PCB Layout

DETAILED DESCRIPTION

The SiP4282 is a P-Channel MOSFET power switches designed for high-side slew rate controlled load-switching applications. Once turned on, the slew-rate control circuitry is activated and current is ramped in a linear fashion until it reaches the level required for the output load condition. This is accomplished by first elevating the gate voltage of the MOSFET up to its threshold voltage and then by linearly increasing the gate voltage until the MOSFET becomes fully enhanced. At this point, the gate voltage is then quickly increased to the full input voltage to reduce $R_{DS(ON)}$ of the MOSFET switch and minimize any associated power losses. The SiP4282A-2 version has a modest 1 ms turn on slew rate feature, which significantly reduces in-rush current at turned on time and permits the load switch to be implemented with a small input capacitor, or no input capacitor at all, saving cost and space. All versions features a shutdown output discharge circuit which is activated at shutdown (when the part is disabled through the On/Off pin) and discharges the output pin through a small internal resistor hence, turning off the load.

For SiP4282-3, in instances where the input voltage falls below 1.4 V (typically) the under voltage lock-out circuitry protects the MOSFET switch from entering the saturation region or operation by shutting down the chip.

APPLICATION INFORMATION

Input Capacitor

While a bypass capacitor on the input is not required, a 1 μF or larger capacitor for C_{IN} is recommended in almost all applications. The bypass capacitor should be placed as physically close as possible to the SiP4282 to be effective in minimizing transients on the input. Ceramic capacitors are recommended over tantalum because of their ability to withstand input current surges from low impedance sources such as batteries in portable devices.

Output Capacitor

A 0.1 μF capacitor or larger across V_{OUT} and GND is recommended to insure proper slew operation. C_{OUT} may be increased without limit to accommodate any load transient condition with only minimal affect on the SiP4282 turn on slew rate time. There are no ESR or capacitor type requirement.

Enable

The On/Off pin is compatible with both TTL and CMOS logic voltage levels.

Protection Against Reverse Voltage Condition

The P-channel MOSFET pass transistor has an intrinsic diode that is reversed biased when the input voltage is greater than the output voltage. Should V_{OUT} exceed V_{IN} , this intrinsic diode will become forward biased and allow excessive current to flow into the IC thru the V_{OUT} pin and potentially damage the IC device. Therefore extreme care should be taken to prevent V_{OUT} from exceeding V_{IN} .

In conditions where V_{OUT} exceeds V_{IN} a Schottky diode in parallel with the internal intrinsic diode is recommended to protect the SiP4282.

Thermal Considerations

The SiP4282 is designed to maintain a constant output load current. Due to physical limitations of the layout and assembly of the device the maximum switch current is 1.2 A, as stated in the Absolute Maximum Ratings table. However, another limiting characteristic for the safe operating load current is the thermal power dissipation of the package. To obtain the highest power dissipation (and a thermal resistance of 90 $^{\circ}\text{C}/\text{W}$) the power pad of the device should be connected to a heat sink on the printed circuit board.

The maximum power dissipation in any application is dependant on the maximum junction temperature, $T_{J(MAX)} = 125^{\circ}\text{C}$, the junction-to-ambient thermal resistance for the SC-75 PPAK package, $\theta_{J-A} = 90^{\circ}\text{C}/\text{W}$, and the ambient temperature, T_A , which may be formulaically expressed as:

$$P(\text{max.}) = \frac{T_J(\text{max.}) - T_A}{\theta_{J-A}} = \frac{125 - T_A}{90}$$

It then follows that, assuming an ambient temperature of 70 $^{\circ}\text{C}$, the maximum power dissipation will be limited to about 610 mW.

So long as the load current is below the 1.2 A limit, the maximum continuous switch current becomes a function two things: the package power dissipation and the $R_{DS(ON)}$ at the ambient temperature.

As an example let us calculate the worst case maximum load current at $T_A = 70^{\circ}\text{C}$. The worst case $R_{DS(ON)}$ at 25 $^{\circ}\text{C}$ occurs at an input voltage of 1.8 V and is equal to 480 m Ω . The $R_{DS(ON)}$ at 70 $^{\circ}\text{C}$ can be extrapolated from this data using the following formula

$$R_{DS(ON)}(\text{at } 70^{\circ}\text{C}) = R_{DS(ON)}(\text{at } 25^{\circ}\text{C}) \times (1 + T_C \times \Delta T)$$

Where T_C is 3300 ppm/ $^{\circ}\text{C}$. Continuing with the calculation we have

$$R_{DS(ON)}(\text{at } 70^{\circ}\text{C}) = 480 \text{ m}\Omega \times (1 + 0.0033 \times (70^{\circ}\text{C} - 25^{\circ}\text{C})) = 551 \text{ m}\Omega$$

The maximum current limit is then determined by

$$I_{LOAD}(\text{max.}) < \sqrt{\frac{P(\text{max.})}{R_{DS(ON)}}}$$

which in case is 1.05 A. Under the stated input voltage condition, if the 1.05 A current limit is exceeded the internal die temperature will rise and eventually, possibly damage the device.



Disclaimer

All product specifications and data are subject to change without notice.

Vishay Intertechnology, Inc., its affiliates, agents, and employees, and all persons acting on its or their behalf (collectively, "Vishay"), disclaim any and all liability for any errors, inaccuracies or incompleteness contained herein or in any other disclosure relating to any product.

Vishay disclaims any and all liability arising out of the use or application of any product described herein or of any information provided herein to the maximum extent permitted by law. The product specifications do not expand or otherwise modify Vishay's terms and conditions of purchase, including but not limited to the warranty expressed therein, which apply to these products.

No license, express or implied, by estoppel or otherwise, to any intellectual property rights is granted by this document or by any conduct of Vishay.

The products shown herein are not designed for use in medical, life-saving, or life-sustaining applications unless otherwise expressly indicated. Customers using or selling Vishay products not expressly indicated for use in such applications do so entirely at their own risk and agree to fully indemnify Vishay for any damages arising or resulting from such use or sale. Please contact authorized Vishay personnel to obtain written terms and conditions regarding products designed for such applications.

Product names and markings noted herein may be trademarks of their respective owners.

TDFN4 1.2 x 1.6 CASE OUTLINE

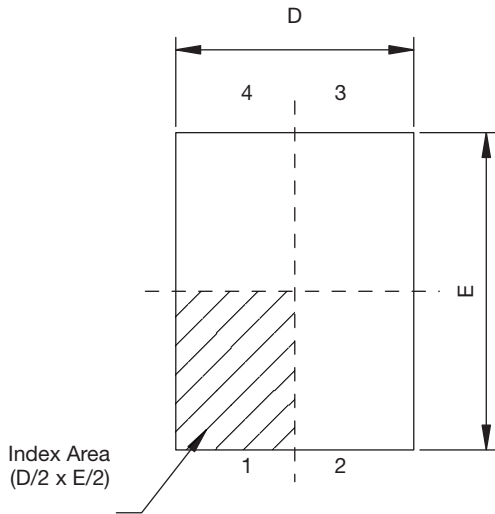

Top View

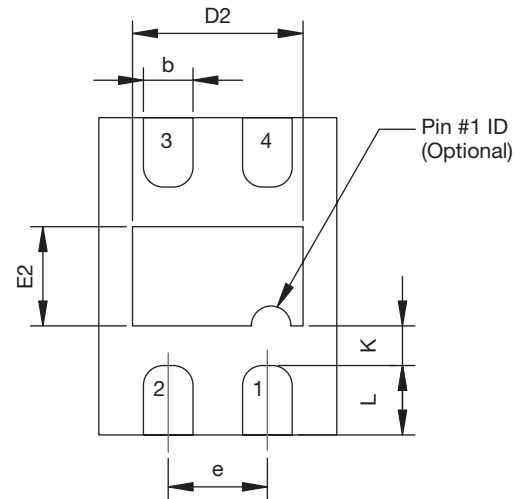

Bottom View

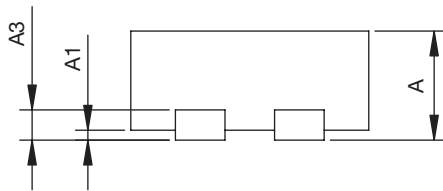

Side View

| DIM. | MILLIMETERS | | | INCHES | | |
|------|-------------|------|------|--------|-------|-------|
| | MIN. | NOM. | MAX. | MIN. | NOM. | MAX. |
| A | 0.50 | 0.55 | 0.60 | 0.020 | 0.022 | 0.024 |
| A1 | 0.00 | - | 0.05 | 0.00 | - | 0.002 |
| A3 | 0.15 REF | | | 0.006 | | |
| b | 0.20 | 0.25 | 0.30 | 0.008 | 0.010 | 0.012 |
| D | 1.15 | 1.20 | 1.25 | 0.045 | 0.047 | 0.049 |
| D2 | 0.81 | 0.86 | 0.91 | 0.032 | 0.034 | 0.036 |
| e | 0.50 BSC | | | 0.020 | | |
| E | 1.55 | 1.60 | 1.65 | 0.061 | 0.063 | 0.065 |
| E2 | 0.45 | 0.50 | 0.55 | 0.018 | 0.020 | 0.022 |
| K | 0.20 | - | - | 0.008 | - | - |
| L | 0.30 | 0.35 | 0.40 | 0.012 | 0.014 | 0.016 |

ECN: C10-0043-Rev. A, 08-Feb-10
 DWG: 5995

PowerPAK® SC75-6L (Power IC only)

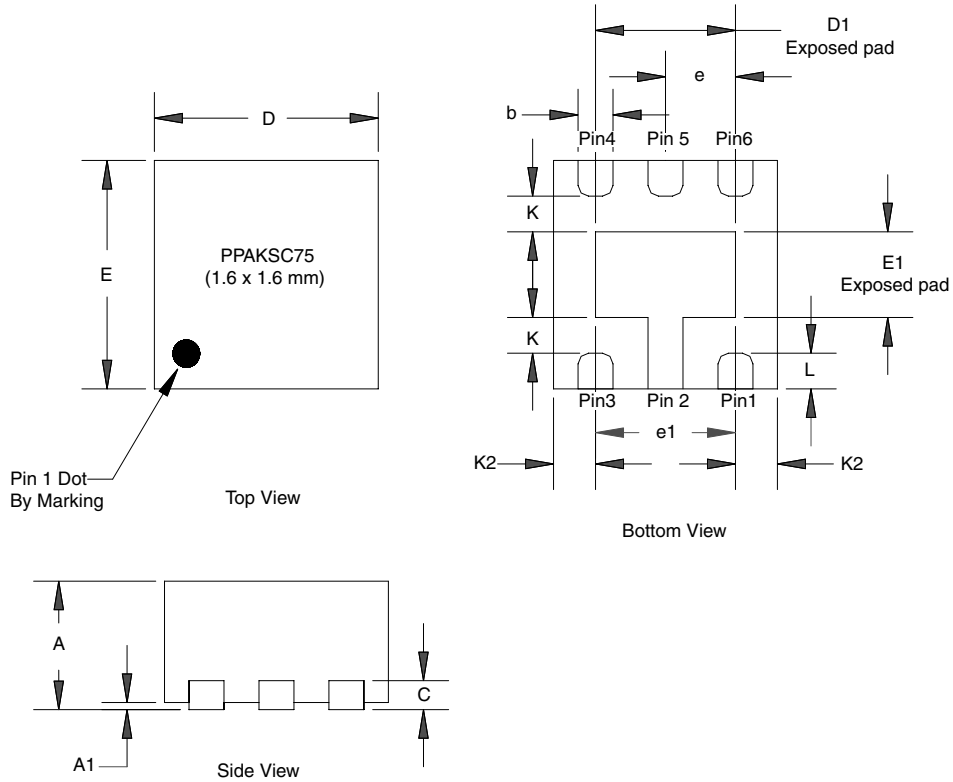

| DIM | MILLIMETERS | | | INCHES | | |
|--------------------------------|-------------|------|------|-----------|-------|-------|
| | Min | Nom | Max | Min | Nom | Max |
| A | 0.70 | 0.75 | 0.80 | 0.028 | 0.030 | 0.032 |
| A1 | 0 | - | 0.05 | 0 | - | 0.002 |
| b | 0.20 | 0.25 | 0.30 | 0.008 | 0.010 | 0.012 |
| C | 0.15 | 0.20 | 0.25 | 0.006 | 0.008 | 0.010 |
| D | 1.55 | 1.60 | 1.65 | 0.0061 | 0.063 | 0.065 |
| D1 | 0.95 | 1.00 | 1.05 | 0.037 | 0.039 | 0.041 |
| E | 1.55 | 1.60 | 1.65 | 0.061 | 0.063 | 0.065 |
| E1 | 0.55 | 0.60 | 0.65 | 0.022 | 0.024 | 0.026 |
| e | 0.50 BSC | | | 0.020 BSC | | |
| e1 | 1.00 BSC | | | 0.039 BSC | | |
| K | 0.15 | - | - | 0.006 | - | - |
| K2 | 0.20 | - | - | 0.008 | | |
| L | 0.20 | 0.25 | 0.30 | 0.008 | 0.010 | 0.012 |
| ECN: S-60845-Rev. B, 22-May-06 | | | | | | |
| DWG: 5953 | | | | | | |



Disclaimer

ALL PRODUCT, PRODUCT SPECIFICATIONS AND DATA ARE SUBJECT TO CHANGE WITHOUT NOTICE TO IMPROVE RELIABILITY, FUNCTION OR DESIGN OR OTHERWISE.

Vishay Intertechnology, Inc., its affiliates, agents, and employees, and all persons acting on its or their behalf (collectively, "Vishay"), disclaim any and all liability for any errors, inaccuracies or incompleteness contained in any datasheet or in any other disclosure relating to any product.

Vishay makes no warranty, representation or guarantee regarding the suitability of the products for any particular purpose or the continuing production of any product. To the maximum extent permitted by applicable law, Vishay disclaims (i) any and all liability arising out of the application or use of any product, (ii) any and all liability, including without limitation special, consequential or incidental damages, and (iii) any and all implied warranties, including warranties of fitness for particular purpose, non-infringement and merchantability.

Statements regarding the suitability of products for certain types of applications are based on Vishay's knowledge of typical requirements that are often placed on Vishay products in generic applications. Such statements are not binding statements about the suitability of products for a particular application. It is the customer's responsibility to validate that a particular product with the properties described in the product specification is suitable for use in a particular application. Parameters provided in datasheets and/or specifications may vary in different applications and performance may vary over time. All operating parameters, including typical parameters, must be validated for each customer application by the customer's technical experts. Product specifications do not expand or otherwise modify Vishay's terms and conditions of purchase, including but not limited to the warranty expressed therein.

Except as expressly indicated in writing, Vishay products are not designed for use in medical, life-saving, or life-sustaining applications or for any other application in which the failure of the Vishay product could result in personal injury or death. Customers using or selling Vishay products not expressly indicated for use in such applications do so at their own risk and agree to fully indemnify and hold Vishay and its distributors harmless from and against any and all claims, liabilities, expenses and damages arising or resulting in connection with such use or sale, including attorneys fees, even if such claim alleges that Vishay or its distributor was negligent regarding the design or manufacture of the part. Please contact authorized Vishay personnel to obtain written terms and conditions regarding products designed for such applications.

No license, express or implied, by estoppel or otherwise, to any intellectual property rights is granted by this document or by any conduct of Vishay. Product names and markings noted herein may be trademarks of their respective owners.

Компания «Life Electronics» занимается поставками электронных компонентов импортного и отечественного производства от производителей и со складов крупных дистрибьюторов Европы, Америки и Азии.

С конца 2013 года компания активно расширяет линейку поставок компонентов по направлению коаксиальный кабель, кварцевые генераторы и конденсаторы (керамические, пленочные, электролитические), за счёт заключения дистрибьюторских договоров

Мы предлагаем:

- Конкурентоспособные цены и скидки постоянным клиентам.
- Специальные условия для постоянных клиентов.
- Подбор аналогов.
- Поставку компонентов в любых объемах, удовлетворяющих вашим потребностям.
- Приемлемые сроки поставки, возможна ускоренная поставка.
- Доставку товара в любую точку России и стран СНГ.
- Комплексную поставку.
- Работу по проектам и поставку образцов.
- Формирование склада под заказчика.
- Сертификаты соответствия на поставляемую продукцию (по желанию клиента).
- Тестирование поставляемой продукции.
- Поставку компонентов, требующих военную и космическую приемку.
- Входной контроль качества.
- Наличие сертификата ISO.

В составе нашей компании организован Конструкторский отдел, призванный помогать разработчикам, и инженерам.

Конструкторский отдел помогает осуществить:

- Регистрацию проекта у производителя компонентов.
- Техническую поддержку проекта.
- Защиту от снятия компонента с производства.
- Оценку стоимости проекта по компонентам.
- Изготовление тестовой платы монтаж и пусконаладочные работы.



Тел: +7 (812) 336 43 04 (многоканальный)

Email: org@lifeelectronics.ru