

Multilayer NTC Thermistors (Automotive Grade)

Series: ERTJ-M



Features

- Surface Mount Device (0402·0603)
- Highly reliable multilayer / monolithic structure
- Wide temperature operating range (-40 to 150 °C)
- Environmentally-friendly lead-free
- AEC-Q200 compliant
- RoHS compliant

Recommended Applications

- For car audio system
- For ECUs
- For electric pumps and compressors
- For LED lights
- For batteries
- For temperature detection of various circuits

Explanation of Part Numbers

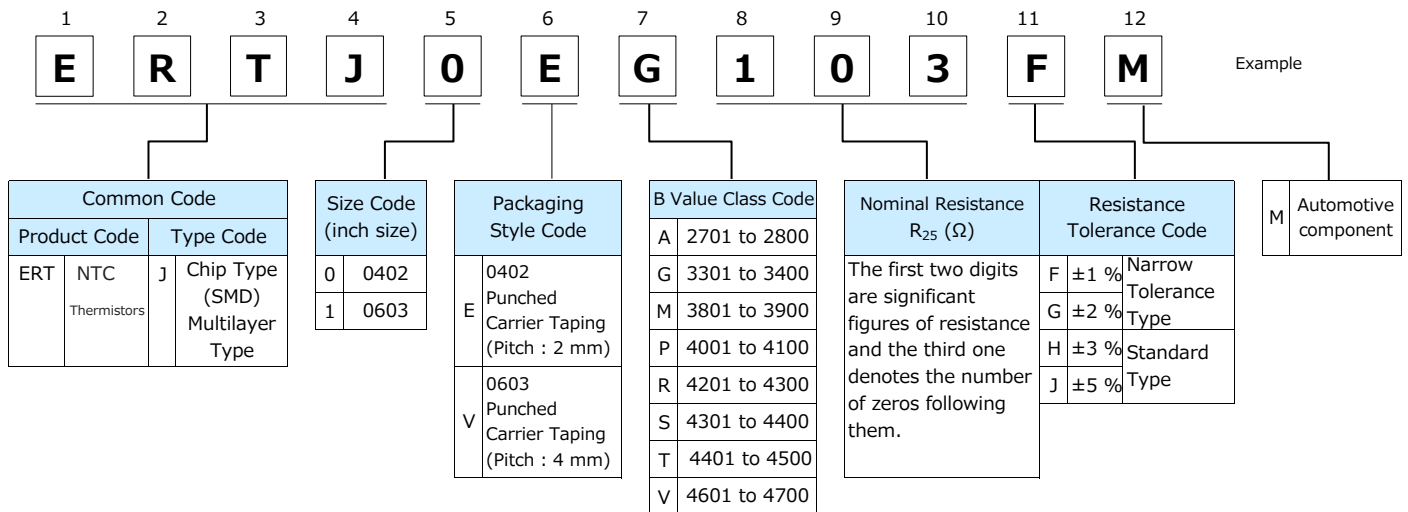

Construction

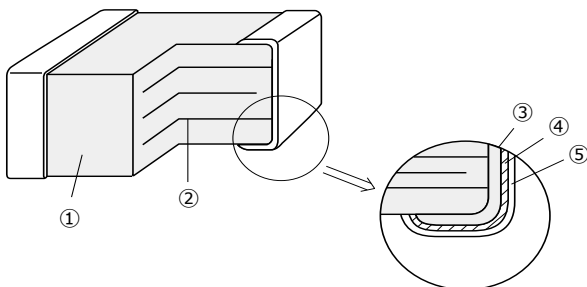

| No. | Name | |
|-----|-------------------------|------------------------|
| ① | Semiconductive Ceramics | |
| ② | Internal electrode | |
| ③ | Terminal electrode | Substrate electrode |
| ④ | | Intermediate electrode |
| ⑤ | | External electrode |

| Ratings | | |
|------------------------------------|-------------------------|-------------------------|
| Size code (inch size) | 0(0402) | 1(0603) |
| Operating Temperature Range | -40 to 150 °C | |
| Rated Maximum Power Dissipation *1 | 66 mW | 100 mW |
| Dissipation Factor *2 | Approximately 2 mW / °C | Approximately 3 mW / °C |

- *1 Rated Maximum Power Dissipation : The maximum power that can be continuously applied at the rated ambient temperature.
 - The maximum value of power, and rated power is same under the condition of ambient temperature 25 °C or less. If the temperature exceeds 25 °C, rated power depends on the decreased power dissipation curve.
 - Please see "Operating Power" for details.
- *2 Dissipation factor : The constant amount power required to raise the temperature of the Thermistor 1 °C through self heat generation under stable temperatures.
 - Dissipation factor is the reference value when mounted on a glass epoxy board (1.6 mmT).

Part Number List

● 0402 inch size

| Part Number | Nominal Resistance at 25 °C (Ω) | B Value at 25/50(K) | B Value at 25/85(K) |
|--------------|---------------------------------|---------------------|---------------------|
| ERTJ0EG202GM | 2 kΩ±2 % | (3380 K) | 3410 K±0.5 % |
| ERTJ0EG202HM | 2 kΩ±3 % | (3380 K) | 3410 K±0.5 % |
| ERTJ0EG202JM | 2 kΩ±5 % | (3380 K) | 3410 K±0.5 % |
| ERTJ0EG103□M | 10 kΩ | 3380 K±1 % | 3435 K±1 % |
| ERTJ0EP473□M | 47 kΩ | 4050 K±1 % | (4100 K) |
| ERTJ0ER104□M | 100 kΩ | 4250 K±1 % | (4300 K) |
| ERTJ0ET104□M | 100 kΩ | 4485 K±1 % | (4550 K) |
| ERTJ0EV104□M | 100 kΩ | 4700 K±1 % | (4750 K) |
| ERTJ0EV474□M | 470 kΩ | 4700 K±1 % | (4750 K) |

● 0603 inch size

| Part Number | Nominal Resistance at 25 °C (Ω) | B Value at 25/50(K) | B Value at 25/85(K) |
|--------------|---------------------------------|---------------------|---------------------|
| ERTJ1VK102□M | 1 kΩ | 3650 K±1 % | (3690 K) |
| ERTJ1VG103□M | 10 kΩ | 3380 K±1 % | 3435 K±1 % |
| ERTJ1VP473□M | 47 kΩ | 4100 K±1 % | (4150 K) |
| ERTJ1VR104□M | 100 kΩ | 4200 K±1 % | (4250 K) |
| ERTJ1VV104□M | 100 kΩ | 4700 K±1 % | (4750 K) |
| ERTJ1VT224□M | 220 kΩ | 4485 K±1 % | (4550 K) |

□ : Resistance Tolerance Code
 (F:±1 %, G:±2 %, H:±3 %, J:±5 %)

● Temperature and Resistance value (the resistance value at 25 °C is set to 1)/ Reference values

| | ERTJ□□G~ | ERTJ1VK~ | ERTJ0EP~ | ERTJ1VP~ | ERTJ0ER~ | ERTJ1VR~ | ERTJ□□T~ | ERTJ□□V~ |
|--------------------|----------|----------|----------|----------|----------|----------|----------|----------|
| B _{25/50} | (3380 K) | 3650 K | 4050 K | 4100 K | 4250 K | 4200 K | 4485 K | 4700 K |
| B _{25/85} | 3435 K | (3690 K) | (4100 K) | (4150 K) | (4300 K) | (4250 K) | (4550 K) | (4750 K) |
| T(°C) | | | | | | | | |
| -40 | 20.52 | 25.77 | 33.10 | 34.56 | 42.40 | 40.49 | 46.47 | 59.76 |
| -35 | 15.48 | 19.10 | 24.03 | 24.99 | 29.96 | 28.81 | 32.92 | 41.10 |
| -30 | 11.79 | 14.29 | 17.63 | 18.26 | 21.42 | 20.72 | 23.55 | 28.61 |
| -25 | 9.069 | 10.79 | 13.06 | 13.48 | 15.50 | 15.07 | 17.00 | 20.14 |
| -20 | 7.037 | 8.221 | 9.761 | 10.04 | 11.33 | 11.06 | 12.38 | 14.33 |
| -15 | 5.507 | 6.312 | 7.362 | 7.546 | 8.370 | 8.198 | 9.091 | 10.31 |
| -10 | 4.344 | 4.883 | 5.599 | 5.720 | 6.244 | 6.129 | 6.729 | 7.482 |
| -5 | 3.453 | 3.808 | 4.291 | 4.369 | 4.699 | 4.622 | 5.019 | 5.481 |
| 0 | 2.764 | 2.993 | 3.312 | 3.362 | 3.565 | 3.515 | 3.772 | 4.050 |
| 5 | 2.227 | 2.372 | 2.574 | 2.604 | 2.725 | 2.694 | 2.854 | 3.015 |
| 10 | 1.806 | 1.892 | 2.013 | 2.030 | 2.098 | 2.080 | 2.173 | 2.262 |
| 15 | 1.474 | 1.520 | 1.584 | 1.593 | 1.627 | 1.618 | 1.666 | 1.710 |
| 20 | 1.211 | 1.229 | 1.255 | 1.258 | 1.271 | 1.267 | 1.286 | 1.303 |
| 25 | 1 | 1 | 1 | 1 | 1 | 1 | 1 | 1 |
| 30 | 0.8309 | 0.8185 | 0.8016 | 0.7994 | 0.7923 | 0.7944 | 0.7829 | 0.7734 |
| 35 | 0.6941 | 0.6738 | 0.6461 | 0.6426 | 0.6318 | 0.6350 | 0.6168 | 0.6023 |
| 40 | 0.5828 | 0.5576 | 0.5235 | 0.5194 | 0.5069 | 0.5108 | 0.4888 | 0.4721 |
| 45 | 0.4916 | 0.4639 | 0.4266 | 0.4222 | 0.4090 | 0.4132 | 0.3896 | 0.3723 |
| 50 | 0.4165 | 0.3879 | 0.3496 | 0.3451 | 0.3320 | 0.3363 | 0.3123 | 0.2954 |
| 55 | 0.3543 | 0.3258 | 0.2881 | 0.2837 | 0.2709 | 0.2752 | 0.2516 | 0.2356 |
| 60 | 0.3027 | 0.2749 | 0.2386 | 0.2344 | 0.2222 | 0.2263 | 0.2037 | 0.1889 |
| 65 | 0.2595 | 0.2330 | 0.1985 | 0.1946 | 0.1831 | 0.1871 | 0.1658 | 0.1523 |
| 70 | 0.2233 | 0.1984 | 0.1659 | 0.1623 | 0.1516 | 0.1554 | 0.1357 | 0.1236 |
| 75 | 0.1929 | 0.1696 | 0.1393 | 0.1359 | 0.1261 | 0.1297 | 0.1117 | 0.1009 |
| 80 | 0.1672 | 0.1456 | 0.1174 | 0.1143 | 0.1054 | 0.1087 | 0.09236 | 0.08284 |
| 85 | 0.1451 | 0.1255 | 0.09937 | 0.09658 | 0.08843 | 0.09153 | 0.07675 | 0.06834 |
| 90 | 0.1261 | 0.1087 | 0.08442 | 0.08189 | 0.07457 | 0.07738 | 0.06404 | 0.05662 |
| 95 | 0.1097 | 0.09440 | 0.07200 | 0.06969 | 0.06316 | 0.06567 | 0.05366 | 0.04712 |
| 100 | 0.09563 | 0.08229 | 0.06166 | 0.05957 | 0.05371 | 0.05596 | 0.04518 | 0.03939 |
| 105 | 0.08357 | 0.07195 | 0.05306 | 0.05117 | 0.04585 | 0.04786 | 0.03825 | 0.03308 |
| 110 | 0.07317 | 0.06311 | 0.04587 | 0.04415 | 0.03929 | 0.04108 | 0.03255 | 0.02791 |
| 115 | 0.06421 | 0.05552 | 0.03979 | 0.03823 | 0.03378 | 0.03539 | 0.02781 | 0.02364 |
| 120 | 0.05650 | 0.04899 | 0.03460 | 0.03319 | 0.02913 | 0.03059 | 0.02382 | 0.02009 |
| 125 | 0.04986 | 0.04336 | 0.03013 | 0.02886 | 0.02519 | 0.02652 | 0.02043 | 0.01712 |
| 130 | 0.04413 | 0.03849 | 0.02629 | 0.02513 | 0.02184 | 0.02307 | 0.01755 | 0.01464 |
| 135 | 0.03916 | 0.03426 | 0.02298 | 0.02193 | 0.01898 | 0.02013 | 0.01511 | 0.01256 |
| 140 | 0.03483 | 0.03058 | 0.02013 | 0.01918 | 0.01654 | 0.01762 | 0.01304 | 0.01080 |
| 145 | 0.03105 | 0.02736 | 0.01767 | 0.01680 | 0.01445 | 0.01546 | 0.01127 | 0.00931 |
| 150 | 0.02774 | 0.02454 | 0.01553 | 0.01476 | 0.01265 | 0.01361 | 0.00976 | 0.00806 |

$$B_{25/50} = \frac{\ln(R_{25}/R_{50})}{1/298.15 - 1/323.15}$$

$$B_{25/85} = \frac{\ln(R_{25}/R_{85})}{1/298.15 - 1/358.15}$$

R₂₅=Resistance at 25.0±0.1 °C
 R₅₀=Resistance at 50.0±0.1 °C
 R₈₅= Resistance at 85.0±0.1 °C

Specification and Test Method

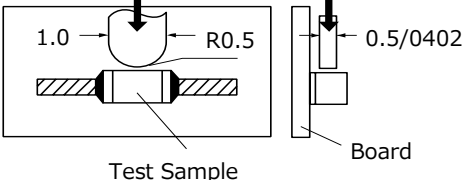
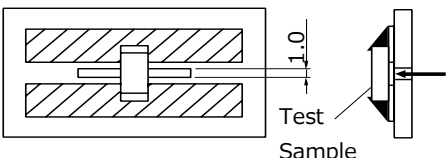
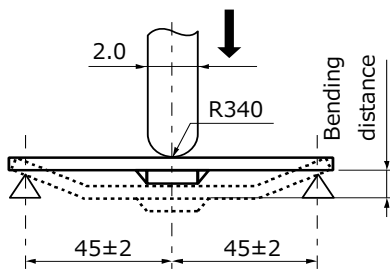
| Item | Specifications | Testing Method | | | | | | | | | |
|------------------------------------------------|-------------------------------------------------------------------------------------------------------------------------------------|------------------------------------------------------------------------------------------------------------------------------------------------------------------------------------------------------------------------------------------------------------------------------------------------------------------------------------------------------------------------------------------------------------------------------------------------------------------------------------------------------------------------------------------------------------------------------------------------------------------------------------------------------|--|----------------|----------------|--------------------|---------------|---------------|--------------------|---------------|---------------|
| Rated Zero-power Resistance (R ₂₅) | Within the specified tolerance. | The value is measured at a power that the influence of self-heat generation can be negligible (0.1 mW or less), at the rated ambient temperature of 25.0 ± 0.1 °C. | | | | | | | | | |
| B Value | Shown in each Individual Specification. ※Individual Specification shall specify B _{25/50} or B _{25/85} . | The Zero-power resistances; R ₁ and R ₂ , shall be measured respectively at T ₁ (deg.C) T ₂ (deg.C) . The B value is calculated by the following equation. $B_{T_1/T_2} = \frac{\ln(R_1) - \ln(R_2)}{1/(T_1 + 273.15) - 1/(T_2 + 273.15)}$ <table border="1" style="margin-left: auto; margin-right: auto;"> <thead> <tr> <th></th> <th>T₁</th> <th>T₂</th> </tr> </thead> <tbody> <tr> <td>B_{25/50}</td> <td>25.0 ± 0.1 °C</td> <td>50.0 ± 0.1 °C</td> </tr> <tr> <td>B_{25/85}</td> <td>25.0 ± 0.1 °C</td> <td>85.0 ± 0.1 °C</td> </tr> </tbody> </table> | | T ₁ | T ₂ | B _{25/50} | 25.0 ± 0.1 °C | 50.0 ± 0.1 °C | B _{25/85} | 25.0 ± 0.1 °C | 85.0 ± 0.1 °C |
| | T ₁ | T ₂ | | | | | | | | | |
| B _{25/50} | 25.0 ± 0.1 °C | 50.0 ± 0.1 °C | | | | | | | | | |
| B _{25/85} | 25.0 ± 0.1 °C | 85.0 ± 0.1 °C | | | | | | | | | |
| Adhesion | The terminal electrode shall be free from peeling or signs of peeling. | <p>Applied force : Size 0402, 0603 : 5 N Duration : 10 s</p> <p>Size : 0402</p>  <p>Test Sample</p> <p>Board</p> <p>Size : 0603</p>  <p>Test Sample</p> <p>Unit : mm</p> | | | | | | | | | |
| Bending Strength | There shall be no cracks and other mechanical damage. R ₂₅ change : within ± 5 % | <p>Bending distance : 2 mm Bending speed : 1 mm/ s</p>  <p>Unit : mm</p> | | | | | | | | | |
| Resistance to Vibration | There shall be no cracks and other mechanical damage. R ₂₅ change : within ± 2 % B Value change : within ± 1 % | <p>Solder samples on a testing substrate, then apply vibration to them.</p> <p>Acceleration : 5 G Vibrational frequency : 10 to 2000 Hz Sweep time : 20 minutes 12 cycles in three directions, which are perpendicular to each other</p> | | | | | | | | | |
| Resistance to Impact | There shall be no cracks and other mechanical damage. R ₂₅ change : within ± 2 % B Value change : within ± 1 % | <p>Solder samples on a testing substrate, then apply impacts to them.</p> <p>Pulse waveform : Semisinusoidal wave, 11 ms Impact acceleration : 50 G Impact direction : X-X', Y-Y', Z-Z' In 6 directions, three times each</p> | | | | | | | | | |

Specification and Test Method

| Item | Specifications | Testing Method | | | | | | | | | |
|------------------------------|---------------------------------------------------------------------------------------------------------------------------------|---------------------------------------------------------------------------------------------------------------------------------------------------------------------------------------------------------------------------------------------------------|-----------|------------|-----------|---|-----------|------------|---|------------|------------|
| Resistance to Soldering Heat | There shall be no cracks and other mechanical damage. R25 change : within ± 2 % B Value change : within ± 1 % | Soldering bath method Solder temperature : 260 ± 5 °C, 270 ± 5 °C Dipping period : 3.0 ± 0.5 s, 10.0 ± 0.5 s Preheat condition | | | | | | | | | |
| | | <table border="1"> <thead> <tr> <th>Step</th> <th>Temp (°C)</th> <th>Period(s)</th> </tr> </thead> <tbody> <tr> <td>1</td> <td>80 to 100</td> <td>120 to 180</td> </tr> <tr> <td>2</td> <td>150 to 200</td> <td>120 to 180</td> </tr> </tbody> </table> | Step | Temp (°C) | Period(s) | 1 | 80 to 100 | 120 to 180 | 2 | 150 to 200 | 120 to 180 |
| | | Step | Temp (°C) | Period(s) | | | | | | | |
| | | 1 | 80 to 100 | 120 to 180 | | | | | | | |
| 2 | 150 to 200 | 120 to 180 | | | | | | | | | |
| | | | | | | | | | | | |
| | | | | | | | | | | | |
| Solderability | More than 95 % of the soldered area of both terminal electrodes shall be covered with fresh solder. | Soldering bath method Solder temperature : 230 ± 5 °C Dipping period : 4 ± 1 s Solder : Sn-3.0Ag-0.5Cu | | | | | | | | | |
| Temperature Cycling | R25 change : within ± 2 % B Value change : within ± 1 % | Conditions of one cycle Step 1 : -55 ± 3 °C, 30 ± 3 min Step 2 : Room temp., 3 min max. Step 3 : 125 ± 5 °C, 30 ± 3 min Step 4 : Room temp., 3 min max. Number of cycles : 2000 cycles | | | | | | | | | |
| Humidity | R25 change : within ± 2 % B Value change : within ± 1 % | Temperature : 85 ± 2 °C Relative humidity : 85 ± 5 % Test period : 2000 +48/0 h | | | | | | | | | |
| Biased Humidity | R25 change : within ± 2 % B Value change : within ± 1 % | Temperature : 85 ± 2 °C Relative humidity : 85 ± 5 % Applied power : 10 mW(D.C.) Test period : 2000 +48/0 h | | | | | | | | | |
| Low Temperature Exposure | R25 change : within ± 2 % B Value change : within ± 1 % | Temperature : -40 ± 3 °C Test period : 2000 +48/0 h | | | | | | | | | |
| High Temperature Exposure 1 | R25 change : within ± 2 % B Value change : within ± 1 % | Temperature : 125 ± 3 °C Test period : 2000 +48/0 h | | | | | | | | | |
| High Temperature Exposure 2 | R25 change : within ± 3 % R25 change : within ± 2 % | Temperature : 150 ± 3 °C Test period : 1000 +48/0 h | | | | | | | | | |

Dimensions in mm (not to scale)

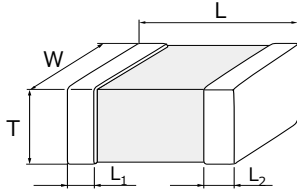

(Unit : mm)

| Size code (inch size) | L | W | T | L ₁ L ₂ |
|-----------------------|-----------|-----------|-----------|-------------------------------|
| 0(0402) | 1.0±0.1 | 0.50±0.05 | 0.50±0.05 | 0.25±0.15 |
| 1(0603) | 1.60±0.15 | 0.8±0.1 | 0.8±0.1 | 0.3±0.2 |

Packaging Methods (Taping)

● Standard Packing Quantities

(Unit : mm)

| Size code (inch size) | Thickness | Kind of Taping | Pitch | Quantity(pcs/reel) |
|-----------------------|-----------|------------------------|-------|--------------------|
| 0(0402) | 0.5 | Punched Carrier Taping | 2 | 10,000 |
| 1(0603) | 0.8 | | 4 | 4,000 |

● 2 mm Pitch (Punched Carrier Taping) Size 0402

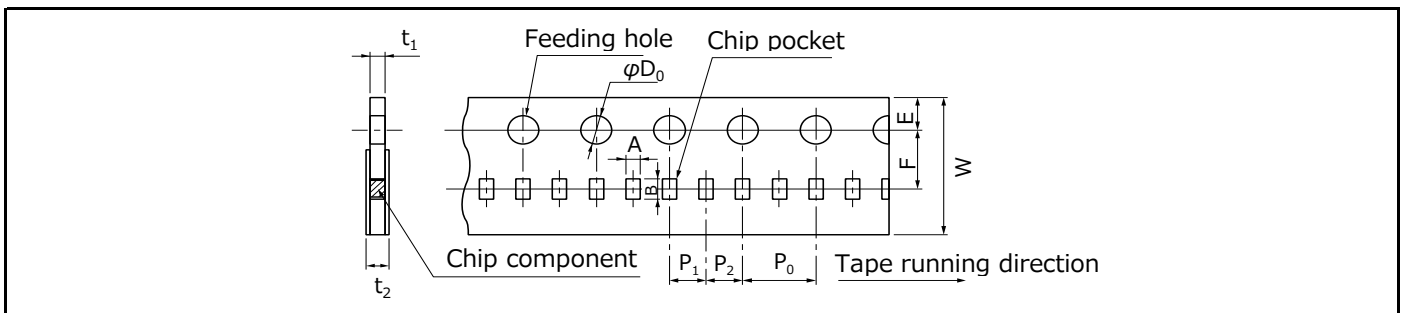

| Symbol | A | B | W | F | E | P ₁ | P ₂ | P ₀ | φ D ₀ | t ₁ | t ₂ |
|-----------|------------|------------|----------|------------|------------|----------------|----------------|----------------|------------------|----------------|----------------|
| Unit (mm) | 0.62 ±0.05 | 1.12 ±0.05 | 8.0 ±0.2 | 3.50 ±0.05 | 1.75 ±0.10 | 2.00 ±0.05 | 2.00 ±0.05 | 4.0 ±0.1 | 1.5 +0.1/0 | 0.7 max. | 1.0 max. |

● 4 mm Pitch (Punched Carrier Taping) Size 0603

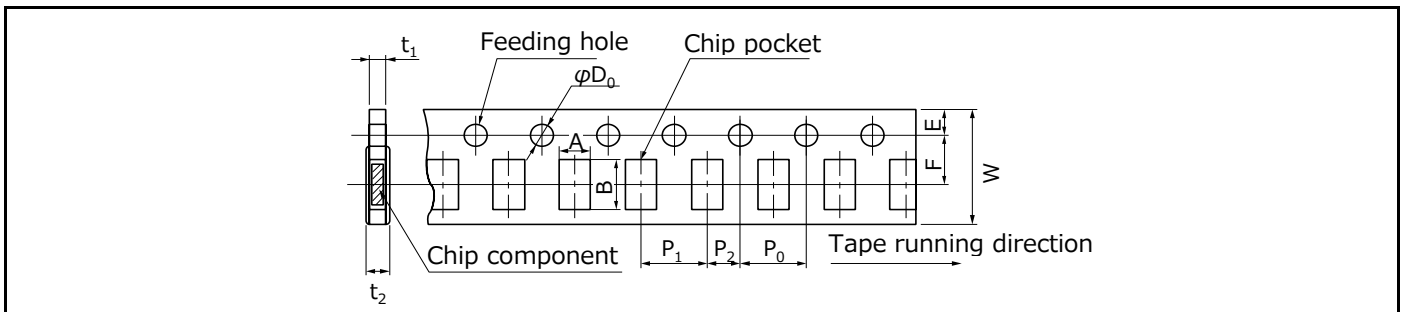

| Symbol | A | B | W | F | E | P ₁ | P ₂ | P ₀ | φ D ₀ | t ₁ | t ₂ |
|-----------|----------|----------|----------|------------|------------|----------------|----------------|----------------|------------------|----------------|----------------|
| Unit (mm) | 1.0 ±0.1 | 1.8 ±0.1 | 8.0 ±0.2 | 3.50 ±0.05 | 1.75 ±0.10 | 4.0 ±0.1 | 2.00 ±0.05 | 4.0 ±0.1 | 1.5 +0.1/0 | 1.1 max. | 1.4 max. |

● Reel for Taping

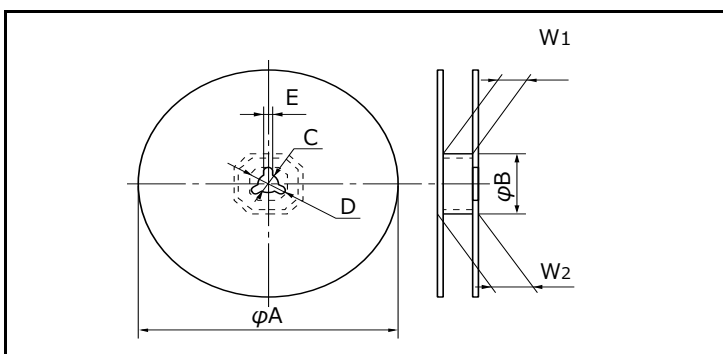

| Symbol | φ A | φ B | C | D |
|-----------|----------|----------------|----------------|----------|
| Unit (mm) | 180+0/-3 | 60.0+1.0/0 | 13.0±0.5 | 21.0±0.8 |
| | E | W ₁ | W ₂ | |
| | 2.0±0.5 | 9.0+1.0/0 | 11.4±1.0 | |

Packaging Methods (Taping)

● Leader Part and Taped End

Leader part

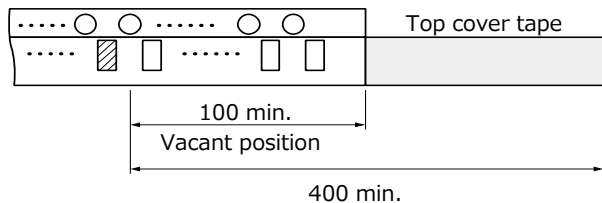

Taped end

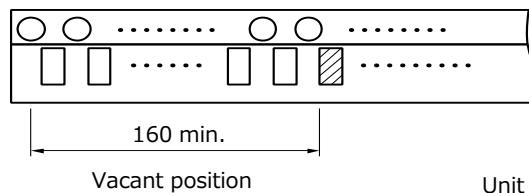

Unit : mm

Minimum Quantity / Packing Unit

| Part Number (inch size) | Minimum Quantity / Packing Unit | Packing Quantity in Carton | Carton L×W×H (mm) |
|----------------------------|------------------------------------|-------------------------------|-------------------|
| ERTJ0 (0402) | 10,000 | 200,000 | 250×200×200 |
| ERTJ1 (0603) | 4,000 | 80,000 | 250×200×200 |

Part No., quantity and country of origin are designated on outer packages in English.

Guidelines and precautions regarding the technical information and use of our products described in this online catalog.

- If you want to use our products described in this online catalog for applications requiring special qualities or reliability, or for applications where the failure or malfunction of the products may directly jeopardize human life or potentially cause personal injury (e.g. aircraft and aerospace equipment, traffic and transportation equipment, combustion equipment, medical equipment, accident prevention, anti-crime equipment, and/or safety equipment), it is necessary to verify whether the specifications of our products fit to such applications. Please ensure that you will ask and check with our inquiry desk as to whether the specifications of our products fit to such applications use before you use our products.
- The quality and performance of our products as described in this online catalog only apply to our products when used in isolation. Therefore, please ensure you evaluate and verify our products under the specific circumstances in which our products are assembled in your own products and in which our products will actually be used.
- If you use our products in equipment that requires a high degree of reliability, regardless of the application, it is recommended that you set up protection circuits and redundancy circuits in order to ensure safety of your equipment.
- The products and product specifications described in this online catalog are subject to change for improvement without prior notice. Therefore, please be sure to request and confirm the latest product specifications which explain the specifications of our products in detail, before you finalize the design of your applications, purchase, or use our products.
- The technical information in this online catalog provides examples of our products' typical operations and application circuits. We do not guarantee the non-infringement of third party's intellectual property rights and we do not grant any license, right, or interest in our intellectual property.
- If any of our products, product specifications and/or technical information in this online catalog is to be exported or provided to non-residents, the laws and regulations of the exporting country, especially with regard to security and export control, shall be observed.

<Regarding the Certificate of Compliance with the EU RoHS Directive/REACH Regulations>

- The switchover date for compliance with the RoHS Directive/REACH Regulations varies depending on the part number or series of our products.
- When you use the inventory of our products for which it is unclear whether those products are compliant with the RoHS Directive/REACH Regulation, please select "Sales Inquiry" in the website inquiry form and contact us.

We do not take any responsibility for the use of our products outside the scope of the specifications, descriptions, guidelines and precautions described in this online catalog.

Multilayer NTC Thermistors (Automotive Grade)

Series: ERTJ

Handling Precautions**[Precautions]**

- **Do not use the products beyond the descriptions in this product catalog.**
- **This product catalog guarantees the quality of the products as individual components. Before you use the products, please make sure to check and evaluate the products in the circumstance where they are installed in your product.**

 **Safety Precautions**

Multilayer NTC Thermistors for Automotive Grade (hereafter referred to as “Thermistors”) are intended to be used in general-purpose applications as measures against Temperature detection and Temperature compensation in automotive Grade equipment.

When subjected to severe electrical, environmental, and/or mechanical stress beyond the specifications, as noted in the Ratings and Specified Conditions section, the Thermistors’ performance may be degraded, or become failure mode, such as short circuit mode and open-circuit mode.

If you use under the condition of short-circuit, heat generation of Thermistors will occur by running large current due to application of voltage. There are possibilities of smoke emission, substrate burn-out, and, in the worst case, fire. For products which require high safety levels, please carefully consider how a single malfunction can affect your product. In order to ensure the safety in the case of a single malfunction, please design products with fail-safe, such as setting up protecting circuits, etc.

We are trying to improve the quality and the reliability, but the durability differs depending on the use environment and the use conditions. On use, be sure to confirm the actual product under the actual use conditions.

- For the following applications and conditions, please be sure to consult with our sales representative in advance and to exchange product specifications which conform to such applications.
 - When your application may have difficulty complying with the safety or handling precautions specified below.
 - High-quality and high-reliability required devices that have possibility of causing hazardous conditions, such as death or injury (regardless of directly or indirectly), due to failure or malfunction of the product.
- ① Aircraft and Aerospace Equipment (artificial satellite, rocket, etc.)
 - ② Submarine Equipment (submarine repeating equipment, etc.)
 - ③ Transportation Equipment (airplanes, trains, ship, traffic signal controllers, etc.)
 - ④ Power Generation Control Equipment
(atomic power, hydroelectric power, thermal power plant control system, etc.)
 - ⑤ Medical Equipment (life-support equipment, pacemakers, dialysis controllers, etc.)
 - ⑥ Information Processing Equipment (large scale computer systems, etc.)
 - ⑦ Electric Heating Appliances, Combustion devices (gas fan heaters, oil fan heaters, etc.)
 - ⑧ Rotary Motion Equipment
 - ⑨ Security Systems
 - ⑩ And any similar types of equipment

 **Strict Observance****1. Confirmation of Rated Performance**

The Thermistors shall be operated within the specified rating/performance.

Applications exceeding the specifications may cause deteriorated performance and/or breakdown, resulting in degradation and/or smoking or ignition of products. The following are strictly observed.

- (1) The Thermistors shall not be operated beyond the specified operating temperature range.
- (2) The Thermistors shall not be operated in excess of the specified maximum power dissipation.

2. The Thermistors shall not be mounted near flammables.

Operating Conditions and Circuit Design

1. Circuit Design

1.1 Operating Temperature and Storage Temperature

When operating a components-mounted circuit, please be sure to observe the "Operating Temperature Range", written in delivery specifications. Storage temperature of PCB after mounting Thermistors, which is not operated, should be within the specified "Storage Temperature Range" in the delivery specifications. Please remember not to use the product under the condition that exceeds the specified maximum temperature.

1.2 Operating Power

The electricity applied to between terminals of Thermistors should be under the specified maximum power dissipation. There are possibilities of breakage and burn-out due to excessive self-heating of Thermistors, if the power exceeds maximum power dissipation when operating. Please consider installing protection circuit for your circuit to improve the safety, in case of abnormal voltage application and so on. Thermistors' performance of temperature detection would be deteriorated if self-heating occurs, even when you use it under the maximum power dissipation. Please consider the maximum power dissipation and dissipation factor.

【Maximum power dissipation】

- The Maximum power that can be continuously applied under static air at a certain ambient temperature. The Maximum power dissipation under an ambient temperature of 25 °C or less is the same with the rated maximum power dissipation, and Maximum power dissipation beyond 25 °C depends on the Decreased power dissipation curve below.

【Dissipation factor】

- The constant amount power required to raise the temperature of the Thermistor 1 °C through self heat generation under stable temperatures.
Dissipation factor (mW/°C) = Power consumption of Thermistor / Temperature rise of element.

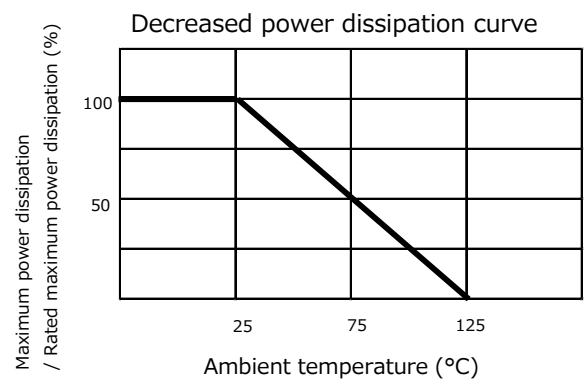

1.3 Environmental Restrictions

The Thermistors does not take the use under the following special environments into consideration. Accordingly, the use in the following special environments, and such environmental conditions may affect the performance of the product; prior to use, verify the performance, reliability, etc. thoroughly.

- ① Use in liquids such as water, oil, chemical, and organic solvent.
- ② Use under direct sunlight, in outdoor or in dusty atmospheres.
- ③ Use in places full of corrosive gases such as sea breeze, Cl₂, H₂S, NH₃, SO₂, and NO_x.
- ④ Use in environment with large static electricity or strong electromagnetic waves or strong radial ray.
- ⑤ Where the product is close to a heating component, or where an inflammable such as a polyvinyl chloride wire is arranged close to the product.
- ⑥ Where this product is sealed or coated with resin etc.
- ⑦ Where solvent, water, or water-soluble detergent is used in flux cleaning after soldering.
(Pay particular attention to water-soluble flux.)
- ⑧ Use in such a place where the product is wetted due to dew condensation.
- ⑨ Use the product in a contaminated state.
Ex.) Do not handle the product such as sticking sebum directly by touching the product after mounting printed circuit board.
- ⑩ Under severe conditions of vibration or impact beyond the specified conditions found in the Specifications.

1.4 Measurement of Resistance

The resistance of the Thermistors varies depending on ambient temperatures and self-heating. To measure the resistance value when examining circuit configuration and conducting receiving inspection and so on, the following points should be taken into consideration:

- ① Measurement temp : 25±0.1 °C
Measurement in liquid (silicon oil, etc.) is recommended for a stable measurement temperature.
- ② Power : 0.10 mW max. 4 terminal measurement with a constant-current power supply is recommended.

2. Design of Printed Circuit Board

2.1 Selection of Printed Circuit Boards

There is a possibility of performance deterioration by heat shock (temperature cycles), which causes cracks, from alumina substrate. Please confirm that the substrate you use does not deteriorate the Thermistors' quality.

2.2 Design of Land Pattern

(1) Recommended land dimensions are shown below. Use the proper amount of solder in order to prevent cracking. Using too much solder places excessive stress on the Thermistors..

Recommended Land Dimensions(Ex.)



| Size Code/EIA | Component dimensions | | | Unit (mm) | | |
|---------------|----------------------|-----|-----|------------|------------|------------|
| | L | W | T | a | b | c |
| 0(0402) | 1.0 | 0.5 | 0.5 | 0.4 to 0.5 | 0.4 to 0.5 | 0.4 to 0.5 |
| 1(0603) | 1.6 | 0.8 | 0.8 | 0.8 to 1.0 | 0.6 to 0.8 | 0.6 to 0.8 |

(2) The land size shall be designed to have equal space, on both right and left side. If the amount of solder on both sides is not equal, the component may be cracked by stress since the side with a larger amount of solder solidifies later during cooling.

Recommended Amount of Solder

(a) Excessive amount (b) Proper amount (c) Insufficient amount

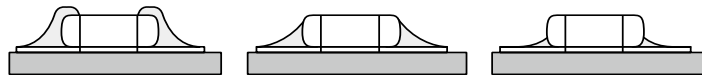

2.3 Utilization of Solder Resist

(1) Solder resist shall be utilized to equalize the amounts of solder on both sides.

(2) Solder resist shall be used to divide the pattern for the following cases;

- Components are arranged closely.
- The Thermistor is mounted near a component with lead wires.
- The Thermistor is placed near a chassis.

Refer to the table below.

Prohibited Applications and Recommended Applications

| Item | Prohibited applications | Improved applications by pattern division |
|-------------------------------------------------|--------------------------------------------------------------------|-------------------------------------------|
| Mixed mounting with a component with lead wires | The lead wire of a Component With lead wires | Solder resist |
| Arrangement near chassis | Chassis Solder(ground solder) Electrode pattern | Solder resist |
| Retro-fitting of component with lead wires | A lead wire of Retrofitted component Soldering iron iron | Solder resist |
| Lateral arrangement | Portion to be Excessively soldered Land | Solder resist |

2.4 Component Layout

To prevent the crack of Thermistors, try to place it on the position that could not easily be affected by the bending stress of substrate while mounting procedures or procedures afterwards. Placement of the Thermistors near heating elements also requires the great care to be taken in order to avoid stresses from rapid heating and cooling.

- (1) To minimize mechanical stress caused by the warp or bending of a PC board, please follow the recommended Thermistors' layout below.



- (2) The following layout is for your reference since mechanical stress near the dividing/breaking position of a PC board varies depending on the mounting position of the Thermistors.



- (3) The magnitude of mechanical stress applied to the Thermistors when dividing the circuit board in descending order is as follows: push back < slit < V-groove < perforation. Also take into account the layout of the Thermistors and the dividing/breaking method.
- (4) When the Thermistors are placed near heating elements such as heater, etc., cracks from thermal stresses may occur under following situation:
- Soldering the Thermistors directly to heating elements.
 - Sharing the land with heating elements.
- If planning to conduct above-mentioned mounting and/or placement, please contact us in advance.

2.5 Mounting Density and Spaces

Intervals between components should not be too narrow to prevent the influence from solder bridges and solder balls. The space between components should be carefully determined.

Precautions for Assembly

1. Storage

- (1) The Thermistors shall be stored between 5 to 40 °C and 20 to 70 % RH, not under severe conditions of high temperature and humidity.
- (2) If stored in a place where humidity, dust, or corrosive gasses (hydrogen sulfide, sulfurous acid, hydrogen chloride and ammonia, etc.) are contained, the solderability of terminals electrodes will be deteriorated. In addition, storage in a place where the heat or direct sunlight exposure occurs will causes or direct sunlight exposure occurs will causes mounting problems due to deformation of tapes and reels and components and taping/reels sticking together.
- (3) Do not store components longer than 6 months. Check the solderability of products that have been stored for more than 6 months before use.

2. Chip Mounting Consideration

- (1) When mounting the Thermistors/components on a PC board, the Thermistor bodies shall be free from excessive impact loads such as mechanical impact or stress due to the positioning, pushing force and displacement of vacuum nozzles during mounting.
- (2) Maintenance and inspection of the Chip Mounter must be performed regularly.
- (3) If the bottom dead center of the vacuum nozzle is too low, the Thermistor will crack from excessive force during mounting. The following precautions and recommendations are for your reference in use.
 - (a) Set and adjust the bottom dead center of the vacuum nozzles to the upper surface of the PC board after correcting the warp of the PC board.
 - (b) Set the pushing force of the vacuum nozzle during mounting to 1 to 3 N in static load.
 - (c) For double surface mounting, apply a supporting pin on the rear surface of the PC board to suppress the bending of the PC board in order to minimize the impact of the vacuum nozzles. Typical examples are shown in the table below.
 - (d) Adjust the vacuum nozzles so that their bottom dead center during mounting is not too low.

| Item | Prohibited mounting | Recommended mounting |
|-------------------------|-----------------------------------------------------------------------------------------------------------------|-------------------------------------------------------------------------------------------------------------------------------------------------------------------|
| Single surface mounting |  Crack |  Supporting pin The supporting pin does not necessarily have to be positioned |
| Double surface mounting |  Separation of solder Crack |  Supporting pin |

- (4) The closing dimensions of the positioning chucks shall be controlled. Maintenance and replacement of positioning chucks shall be performed regularly to prevent chipping or cracking of the Thermistors caused by mechanical impact during positioning due to worn positioning chucks.
- (5) Maximum stroke of the nozzle shall be adjusted so that the maximum bending of PC board does not exceed 0.5 mm at 90 mm span. The PC board shall be supported by an adequate number of supporting pins.

3. Selection of Soldering Flux

Soldering flux may seriously affect the performance of the Thermistors. The following shall be confirmed before use.

- (1) The soldering flux should have a halogen based content of 0.1 wt% (converted to chlorine) or below.
Do not use soldering flux with strong acid.
- (2) When applying water-soluble soldering flux, wash the Thermistors sufficiently because the soldering flux residue on the surface of PC boards may deteriorate the insulation resistance on the Thermistors' surface.

4. Soldering

4.1 Reflow Soldering

The reflow soldering temperature conditions are composed of temperature curves of Preheating, Temp. rise, Heating, Peak and Gradual cooling. Large temperature difference inside the Thermistors caused by rapid heat application to the Thermistors may lead to excessive thermal stresses, contributing to the thermal cracks. The Preheating temperature requires controlling with great care so that tombstone phenomenon may be prevented.

Recommended profile of Reflow Soldering (Ex.)



| Item | Temperature | Period or Speed |
|-------------------|-------------------------------|-----------------|
| ① Preheating | 140 to 180 °C | 60 to 120 s |
| ② Temp. rise | Preheating temp to Peak temp. | 2 to 5 °C / s |
| ③ Heating | 220 °C min. | 60 s max. |
| ④ Peak | 260 °C max. | 10 s max. |
| ⑤ Gradual cooling | Peak temp. to 140 °C | 1 to 4 °C / s |

ΔT : Allowable temperature difference $\Delta T \leq 150$ °C

The rapid cooling (forced cooling) during Gradual cooling part should be avoided, because this may cause defects such as the thermal cracks, etc. When the Thermistors are immersed into a cleaning solvent, make sure that the surface temperatures of the devices do not exceed 100 °C. Performing reflow soldering twice under the conditions shown in the figure above [Recommended profile of Flow soldering (Ex.)] will not cause any problems.

However, pay attention to the possible warp and bending of the PC board.

Recommended soldering condition is for the guideline for ensuring the basic characteristics of the components, not for the stable soldering conditions. Conditions for proper soldering should be set up according to individual conditions. The temperature of this product at the time of mounting changes depending on mounting conditions, therefore, please confirm that Product surface becomes the specified temperature when mounting it on the end product.

4.2 Hand Soldering

Hand soldering typically causes significant temperature change, which may induce excessive thermal stresses inside the Thermistors, resulting in the thermal cracks, etc. In order to prevent any defects, the following should be observed.

- The temperature of the soldering tips should be controlled with special care.
- The direct contact of soldering tips with the Thermistors and/or terminal electrodes should be avoided.
- Dismounted Thermistors shall not be reused.

(1) Condition 1 (with preheating)

- (a) Soldering : Use thread solder (ϕ 1.0 mm or below) which contains flux with low chlorine, developed for precision electronic equipment.
- (b) Preheating : Conduct sufficient pre-heating, and make sure that the temperature difference between solder and Thermistors' surface is 150 °C or less.
- (c) Temperature of Iron tip: 300 °C max.
(The required amount of solder shall be melted in advance on the soldering tip.)
- (d) Gradual cooling : After soldering, the Thermistors shall be cooled gradually at room temperature.

Recommended profile of Hand soldering (Ex.)



ΔT : Allowable temperature difference $\Delta T \leq 150$ °C

(2) Condition 2 (without preheating)

Hand soldering can be performed without preheating, by following the conditions below:

- (a) Soldering iron tip shall never directly touch the ceramic and terminal electrodes of the Thermistors.
- (b) The lands are sufficiently preheated with a soldering iron tip before sliding the soldering iron tip to the terminal electrodes of the Thermistors for soldering.

Conditions of Hand soldering without preheating

| Item | Condition |
|--------------------------------------|------------------|
| Temperature of Iron tip | 270 °C max. |
| Wattage | 20 W max. |
| Shape of Iron tip | ϕ 3 mm max. |
| Soldering time with a soldering iron | 3 s max. |

5. Post Soldering Cleaning

5.1 Cleaning solvent

Soldering flux residue may remain on the PC board if cleaned with an inappropriate solvent. This may deteriorate the electrical characteristics and reliability of the Thermistors.

5.2 Cleaning conditions

Inappropriate cleaning conditions such as insufficient cleaning or excessive cleaning may impair the electrical characteristics and reliability of the Thermistors.

(1) Insufficient cleaning can lead to :

- (a) The halogen substance found in the residue of the soldering flux may cause the metal of terminal electrodes to corrode.
- (b) The halogen substance found in the residue of the soldering flux on the surface of the Thermistors may change resistance values.
- (c) Water-soluble soldering flux may have more remarkable tendencies of (a) and (b) above compared to those of rosin soldering flux.

(2) Excessive cleaning can lead to :

- (a) When using ultrasonic cleaner, make sure that the output is not too large, so that the substrate will not resonate. The resonance causes the cracks in Thermistors and/or solders, and deteriorates the strength of the terminal electrodes. Please follow these conditions for Ultrasonic cleaning:
 - Ultrasonic wave output : 20 W/L max.
 - Ultrasonic wave frequency : 40 kHz max.
 - Ultrasonic wave cleaning time : 5 min. max.

5.3 Contamination of Cleaning solvent

Cleaning with contaminated cleaning solvent may cause the same results as that of insufficient cleaning due to the high density of liberated halogen.

6. Inspection Process

The pressure from measuring terminal pins might bend the PCB when implementing circuit inspection after mounting Thermistors on PCB, and as a result, cracking may occur.

- (1) Mounted PC boards shall be supported by an adequate number of supporting pins on the back with bend settings of 90 mm span 0.5 mm max.
- (2) Confirm that the measuring pins have the right tip shape, are equal in height, have the right pressure and are set in the correct positions. The following figures are for your reference to avoid bending the PC board.

| Item | Prohibited mounting | Recommended mounting |
|---------------------|-----------------------------------------------------------------------------------------------------------|---------------------------------------------------------------------------------------------------------|
| Bending of PC board |  <p>Separated, Crack</p> |  <p>Supporting pin</p> |

7. Protective Coating

Make sure characteristics and reliability when using the resin coating or resin embedding for the purpose of improvement of humidity resistance or gas resistance, or fixing of parts because failures of a thermistors such as 1) ,2) and 3) may be occurred.

- (1) The solvent which contained in the resin permeate into the Thermistors, and it may deteriorate the characteristic.
- (2) When hardening the resin, chemical reaction heat (curing heat generation) happen and it may occurs the infection to the Thermistors.
- (3) The lead wire might be cut down and the soldering crack might be happen by expansion or contraction of resin hardening.

8. Dividing/Breaking of PC Boards

- (1) Please be careful not to stress the substrate with bending/twisting when dividing, after mounting components including Thermistors. Abnormal and excessive mechanical stress such as bending or torsion shown below can cause cracking in the Thermistors.

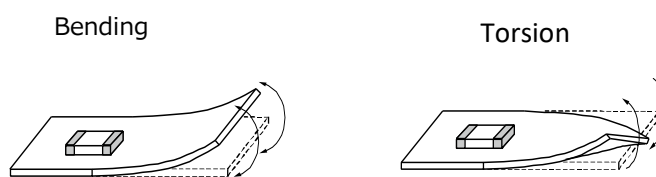

- (2) Dividing/Breaking of the PC boards shall be done carefully at moderate speed by using a jig or apparatus to prevent the Thermistors on the boards from mechanical damage.
- (3) Examples of PCB dividing/breaking jigs: The outline of PC board breaking jig is shown below. When PC board are broken or divided, loading points should be close to the jig to minimize the extent of the bending. Also, planes with no parts mounted on should be used as plane of loading, in order to prevent tensile stress induced by the bending, which may cause cracks of the Thermistors or other parts mounted on the PC boards.



10. Mechanical Impact

- (1) The Thermistors shall be free from any excessive mechanical impact.
The Thermistor body is made of ceramics and may be damaged or cracked if dropped. Never use a Thermistor which has been dropped; their quality may already be impaired, and in that case, failure rate will increase.
- (2) When handling PC boards with Thermistors mounted on them, do not allow the Thermistors to collide with another PC board.
When mounted PC boards are handled or stored in a stacked state, the corner of a PC board might strike Thermistors, and the impact of the strike may cause damage or cracking and can deteriorate the withstand voltage and insulation resistance of the Thermistors.



11. Do not reuse this product after removal from the mounting board.

Precautions for discarding

As to the disposal of the Thermistors, check the method of disposal in each country or region where the modules are incorporated in your products to be used.

Other

The Thermistors precautions described above are typical. For special mounting conditions, please contact us. The technical information in this catalog provides example of our products' typical operations and application circuit.

Applicable laws and regulations , others

1. This product not been manufactured with any ozone depleting chemical controlled under the Montreal Protocol.
2. This product comply with RoHS(Restriction of the use of certain Hazardous Substance in electrical and electronic equipment) (DIRECTIVE 2011/65/EU and 2015/863/EU).
3. All the materials used in this part are registered material under the Law Concerning the Examination and Regulation of Manufacture, etc. of Chemical Substance.
4. If you need the notice by letter of "A preliminary judgement on the Laws of Japan foreign exchange and Foreign Trade Control", be sure to let us know.
5. These products are not dangerous goods on the transportation as identified by UN (United nations) numbers or UN classification.
6. The technical information in this catalog provides example of our products' typical operations and application circuit. We do not guarantee the non-infringement of third party's intellectual property rights and we do not grant any license, Right or interest in our intellectual property.

AEC-Q200 Compliant

The products are tested based on all or part of the test conditions and methods defined in AEC-Q200. Please consult with Panasonic for the details of the product specification and specific evaluation test results, etc., and please review and approve Panasonic's product specification before ordering.

Mouser Electronics

Authorized Distributor

Click to View Pricing, Inventory, Delivery & Lifecycle Information:

Panasonic:

[ERT-J0ES104F](#) [ERT-J0ES104H](#) [ERT-J0EV224F](#) [ERT-J0EV474HM](#) [ERT-J0EV474JM](#) [ERT-J1VV104GM](#) [ERT-J0EV104JM](#) [ERT-J1VG103HM](#) [ERT-J1VT224GM](#) [ERT-J0ER104FM](#) [ERT-J1VR104FM](#) [ERT-J0EP473FM](#) [ERT-J0ER104JM](#) [ERT-J0EV104HM](#) [ERT-J1VV104FM](#) [ERT-J1VV104JM](#) [ERT-J0EG103GM](#) [ERT-J0ET104JM](#) [ERT-J1VT224HM](#) [ERT-J1VG103GM](#) [ERT-J0ET104GM](#) [ERT-J0EP473JM](#) [ERT-J1VP473FM](#) [ERT-J0ER104HM](#) [ERT-J0EV474GM](#) [ERT-J1VR104JM](#) [ERT-J1VG103FM](#) [ERT-J1VP473JM](#) [ERT-J0EG103JM](#) [ERT-J0EV104GM](#) [ERT-J1VR104GM](#) [ERT-J0EP473HM](#) [ERT-J1VT224JM](#) [ERT-J1VG103JM](#) [ERT-J1VT224FM](#) [ERT-J0ER104GM](#) [ERT-J0EV474FM](#) [ERT-J0EV104FM](#) [ERT-J1VR104HM](#) [ERT-J1VP473HM](#) [ERT-J0ET104FM](#) [ERT-J0ET104HM](#) [ERT-J1VV104HM](#) [ERT-J0EG103HM](#) [ERT-J0EP473GM](#) [ERT-J1VP473GM](#) [ERT-J0EG103FM](#) [ERT-J1VK102JM](#) [ERT-J0EG202JM](#) [ERT-JZET224J](#) [ERT-J0EG202GM](#) [ERT-JZET154H](#) [ERT-J0EG202HM](#) [ERT-J0ET473J](#) [ERT-JZET154J](#) [ERT-J0ET473H](#) [ERT-J1VK102HM](#) [ERT-J1VK102FM](#) [ERT-J1VK102GM](#) [ERT-JZET224H](#) [ERT-JZEP473G](#) [ERT-JZET472H](#) [ERT-JZEV104G](#) [ERT-J0EP473G](#) [ERT-J0ET154H](#) [ERT-J0EP104H](#) [ERT-J0EP333H](#) [ERT-J0ES104G](#) [ERT-J0EP104J](#) [ERT-J0EP683G](#) [ERT-J1VV104G](#) [ERT-JZET104H](#) [ERT-J0ER104H](#) [ERT-J0EV474G](#) [ERT-J0ET333J](#) [ERT-JZEP683H](#) [ERT-J0EV474F](#) [ERT-JZER104H](#) [ERT-JZER683G](#) [ERT-J1VR103G](#) [ERT-J0EP333G](#) [ERT-J0EP683F](#) [ERT-JZER683J](#) [ERT-J0ER683H](#) [ERT-J1VT224J](#) [ERT-JZER104G](#) [ERT-J0ET333H](#) [ERT-J0EV224G](#) [ERT-JZER683F](#) [ERT-J0EP683H](#) [ERT-J0ER104F](#) [ERT-JZEP683F](#) [ERT-JZEP683J](#) [ERT-J0EM103F](#) [ERT-J1VR332G](#) [ERT-J1VV104F](#) [ERT-J0ER104G](#) [ERT-J0EP333F](#) [ERT-JZEP683G](#) [ERT-JZER104F](#)

Компания «Life Electronics» занимается поставками электронных компонентов импортного и отечественного производства от производителей и со складов крупных дистрибьюторов Европы, Америки и Азии.

С конца 2013 года компания активно расширяет линейку поставок компонентов по направлению коаксиальный кабель, кварцевые генераторы и конденсаторы (керамические, пленочные, электролитические), за счёт заключения дистрибьюторских договоров

Мы предлагаем:

- Конкурентоспособные цены и скидки постоянным клиентам.
- Специальные условия для постоянных клиентов.
- Подбор аналогов.
- Поставку компонентов в любых объемах, удовлетворяющих вашим потребностям.
- Приемлемые сроки поставки, возможна ускоренная поставка.
- Доставку товара в любую точку России и стран СНГ.
- Комплексную поставку.
- Работу по проектам и поставку образцов.
- Формирование склада под заказчика.
- Сертификаты соответствия на поставляемую продукцию (по желанию клиента).
- Тестирование поставляемой продукции.
- Поставку компонентов, требующих военную и космическую приемку.
- Входной контроль качества.
- Наличие сертификата ISO.

В составе нашей компании организован Конструкторский отдел, призванный помогать разработчикам, и инженерам.

Конструкторский отдел помогает осуществить:

- Регистрацию проекта у производителя компонентов.
- Техническую поддержку проекта.
- Защиту от снятия компонента с производства.
- Оценку стоимости проекта по компонентам.
- Изготовление тестовой платы монтаж и пусконаладочные работы.



Тел: +7 (812) 336 43 04 (многоканальный)

Email: org@lifeelectronics.ru