

# CBM-120-UVX

## Ultraviolet Chip On Board LEDs



### Table of Contents

Technology Overview . . . . .	2
Binning Structure . . . . .	3
Ordering Information . . . . .	4
Optical & Electrical Characteristics . . . . .	5
Typical Spectrum . . . . .	9
Radiation Pattern . . . . .	9
Thermal Resistance . . . . .	10
Mechanical Dimensions . . . . .	11
Shipping Tray Outline . . . . .	12
Packing and Shipping Specifications . . . . .	13
Revision History . . . . .	14

### Features:

- Mosaic Array UV LED chipset with surface emitting area of 12 mm<sup>2</sup>, 4:3 aspect ratio
- Chip on board package eliminates the need for complicated assembly process
- Vertical chip UV LED technology for high power density and uniform emission
- Wide Range of UVA Wavelengths: 365 nm-405 nm
- High thermal conductivity common cathode copper coreboard package
- Low-profile window for efficient coupling into small-extendue systems
- Can be operated at drive currents up to 24 A
- Environmentally friendly: REACH, RoHS and Halogen compliant

### Applications:

- 3D printing and Additive Manufacturing
- Machine Vision
- Maskless Lithography
- Curing
  - Inks
  - Coatings
  - Adhesives
- Medical and Scientific Instrumentation

## Technology Overview

Luminus LEDs benefit from innovations in device technology, chip packaging and thermal management. This suite of technologies give engineers and system designers the freedom to develop solutions both high in power and efficiency.

### Luminus Mosaic Array LED Technology

Luminus' vertical chip technology enables LED chips with uniform brightness over the entire chip surface. The optical power and brightness produced by these densely packed chips enable solutions not just to replace arc and halogen lamps but also create novel solutions.

### Packaging Technology

Thermal management is critical in high power LED applications. With a thermal resistance from junction to board of 0.4 °C/W, the CBM-120-UVX has one of the lowest thermal resistances of UV LEDs in the market. The low Rth, along with Luminus chip technology allows users to drive the LEDs at high current densities while maintaining a low junction temperature, thereby resulting in brighter solutions and longer lifetimes.

### Reliability

Luminus LEDs are one of the most reliable light sources in the world. They pass a rigorous suite of environmental and mechanical stress tests, including mechanical shock, vibration, temperature cycling and humidity, and have been qualified for use in high power and high current applications. Luminus UV LEDs are designed for the most demanding applications with median lifetimes exceeding 30,000 hours.

### Environmental Benefits

Luminus LEDs help reduce power consumption and the amount of hazardous waste entering the environment. All Luminus LEDs are RoHS and Halogen compliant and free of hazardous materials, including lead and mercury.

## Binning Structure

CBM-120-UVX LEDs are specified for flux and peak wavelength at a drive current of 9 A with a 20 ms pulse at 25°C and placed into one of the following Power Bins and Wavelength Bins.

### Power Bins<sup>1</sup>

Color	Power Flux Bin (FF)	Minimum Flux (W)	Maximum Flux (W)
UV	I	9.1	10.0
	J	10.0	11.0
	K	11.0	12.1
	L	12.1	13.3
	M	13.3	14.6
	N	14.6	16.1
	P	16.1	17.7
	Q	17.7	19.5

Note 1: Luminus maintains a +/- 6% tolerance on power measurements.

### Peak Wavelength Bins

Color	Wavelength Bin (WWW)	Minimum Wavelength (nm)	Maximum Wavelength (nm)
UV	365	365	370
	370	370	375
	380	380	385
	385	385	390
	400	400	405
	405	405	410

### Ordering Information

Product	Ordering Part Number	Description
CBM-120-UV	CBM-120-UV-X31-FWWW-2#	CBM-120-UV Mosaic Array chipset consisting of 12 UV chips, a thermistor, and a connector on a copper-core PCB.

### Part Number Nomenclature

CBM — 120 — UV — X31 — FWWW-2#

Product Family	Chip Area	Color	Package Configuration	Bin Kit
CBM: Copper-core PCB, Mosaic Array	120:12 mm <sup>2</sup>	UV: Ultraviolet	X31: 28 mm x 26.75 mm - common cathode package See Mechanical Drawing section	See ordering part numbers table below for complete bin definition

### Ordering Part Numbers

Wavelength Range	Radiometric Flux		Wavelength Bins	Ordering Part Number <sup>2,3</sup>
	Bin Kit Flux Code	Min. Flux		
365-375	I	9.1	365, 370	CBM-120-UV-X31-I365-22
380-390	M	13.3	380, 385	CBM-120-UV-X31-M380-22
400-410	L	12.1	400, 405	CBM-120-UV-X31-L400-22

Note 2: A Bin Kit represents a group of flux and wavelength bins that are shippable for a given ordering part number. Individual bins are not always orderable-contact Luminus for special requests.

Note 3: Flux Bin listed is minimum bin shipped - higher bins may be included at Luminus' discretion

**Optical & Electrical Characteristics ( $T_{hs} = 25^{\circ}\text{C}$ )**

UV					
Parameter	Symbol	Values <sup>4</sup>			Unit
Peak Wavelength Range	$\lambda$	365-375	380-390	400-410	nm
Test Current for binning <sup>5</sup>	I	9.0	9.0	9.0	A
Peak Wavelength Typ.	$\lambda_p$	369	385	405	nm
Forward Voltage	$V_{Fmin}$	3.2	2.9	2.9	V
	$V_F$	3.9	3.5	3.3	V
	$V_{Fmax}$	4.3	3.7	3.7	V
Radiometric Flux <sup>6</sup>	$\Phi_{typ}$	10.3	14.4	12.8	W
FWHM at 50% of $\Phi$	$\Delta\lambda_{1/2}$	15	15	15	nm

Parameter	Symbol	Values	Unit
Absolute Minimum Current (CW or Pulsed) <sup>7</sup>	$I_{min}$	0.2	A
Absolute Maximum Current (CW) <sup>8</sup>	$I_{max}$	365 nm- 18 A 385-405 nm- 24 A	A
Absolute Maximum Surge Current <sup>8</sup> (Frequency > 240 Hz, duty cycle =10%, t=1ms)	$I_s$	30	A
Maximum Junction Temperature <sup>8</sup>	$T_{jmax}$	125	$^{\circ}\text{C}$
Storage Temperature Range	$T_s$	-40 to +100	$^{\circ}\text{C}$
Emitting Area <sup>9</sup>	$A_e$	15.6	$\text{mm}^2$
Emitting Area Dimensions		3.4 x 4.6	mm x mm

Note 4: Unless otherwise noted, values listed are typical. Devices are production tested and specified at 9 A with a 20 ms pulse at 25°C.

Note 5: While CBM-120-UVX devices are tested at 9 A, they can be driven at CW currents ranging from 200 mA to 18 A and at duty cycles ranging from 1% to 100%. Drive current and duty cycle should be adjusted as necessary to maintain the junction temperature desired to meet application lifetime requirements.

Note 6: Typical radiometric flux is for reference only. Minimum flux values are guaranteed based on the bin kit ordered. For product roadmap and future performance of devices, contact Luminus.

Note 7: Special design considerations must be observed for operation under 1 A. Please contact Luminus for further information.

Note 8: CBM-120-UVX LEDs are designed for operation to an absolute maximum current as specified above. Product lifetime data is specified at or below maximum drive current. Sustained operation beyond absolute maximum currents will result in a reduction of device life time. Actual device lifetimes will also depend on junction temperature and operation beyond maximum junction temperature is not recommended. Contact Luminus for lifetime derating curves and for further information. In pulsed operation, rise time from 10-90% of forward current should be longer than 0.5  $\mu\text{seconds}$ .

Note 9: Emitting Area is for reference only and subject to change without notice.

## Optical & Electrical Characteristics- 365 nm

### Relative Power vs. Forward Current

$\phi/\phi_{(9A)}$ , 20 ms pulse,  $T_j = 25^\circ\text{C}$

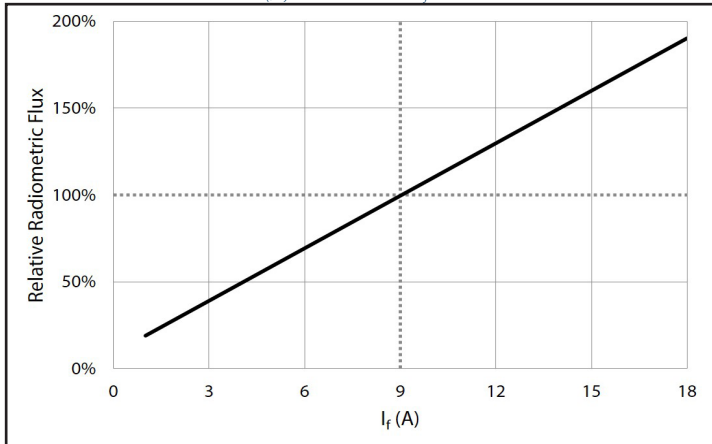

### Relative Power vs. Junction Temperature

$\phi/\phi_{(25^\circ\text{C})}$ , 20 ms pulse, 9A

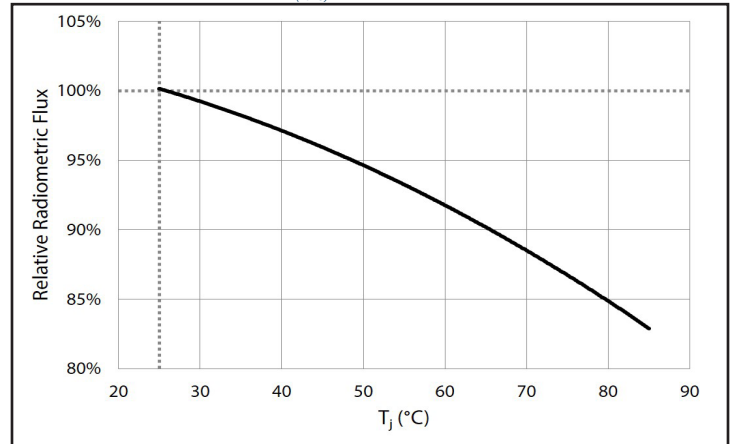

### Peak Wavelength Shift vs. Forward Current

$\lambda_p = \lambda_p(I_f) - \lambda_p(9A)$ , 20 ms pulse,  $T_j = 25^\circ\text{C}$

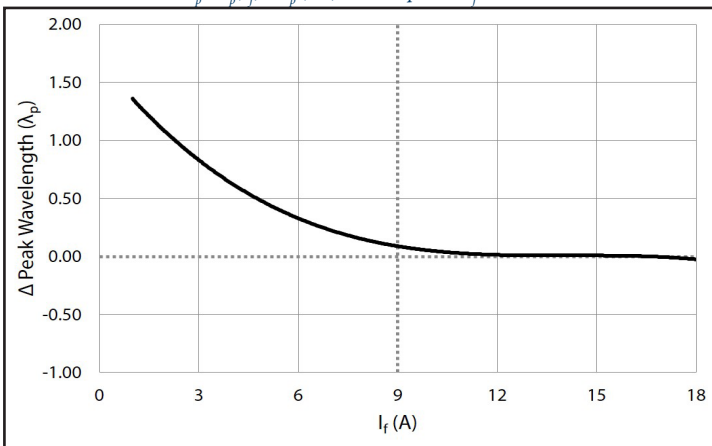

### Peak Wavelength Shift vs. Junction Temperature

$\lambda_p = \lambda_p(T_j) - \lambda_p(25^\circ\text{C})$ , 20 ms pulse,  $I_f = 9A$

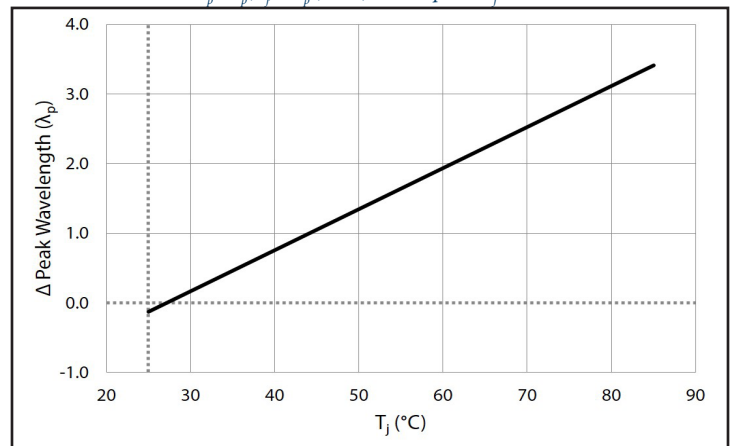

### Forward Voltage vs Forward Current

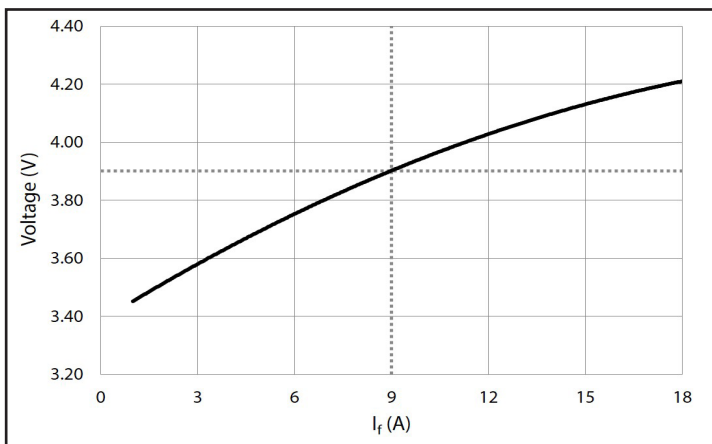

### Forward Voltage Shift vs. Junction Temperature

$\Delta V_f = V_f(T_j) - V_f(25^\circ\text{C})$ , 20 ms pulse,  $I_f = 9A$

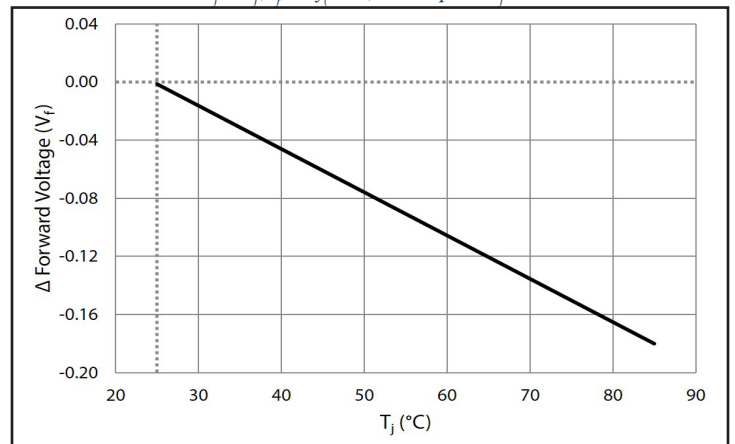

## Optical & Electrical Characteristics- 385 nm

### Relative Power vs. Forward Current

$\phi/\phi_{(9A)}$ , 20 ms pulse,  $T_j = 25^\circ\text{C}$

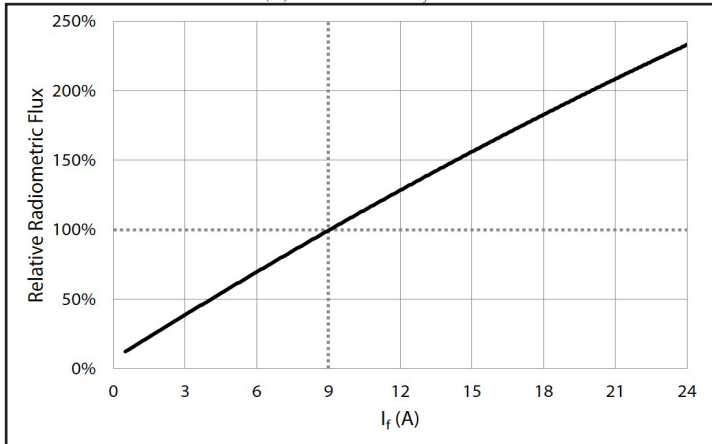

### Relative Power vs. Junction Temperature

$\phi/\phi_{(25^\circ\text{C})}$ , 20 ms pulse, 9A

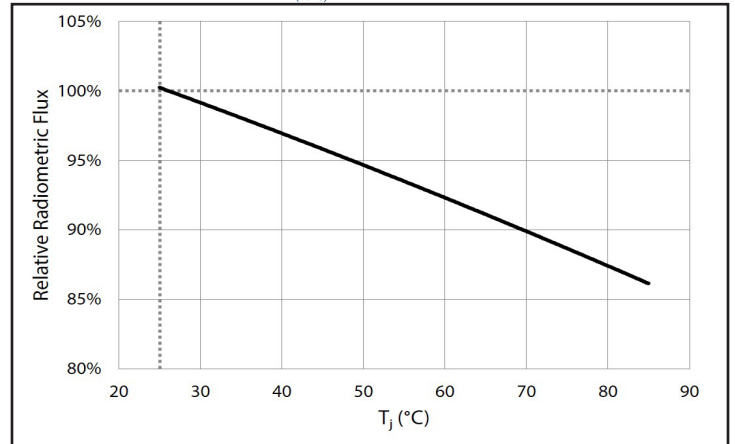

### Peak Wavelength Shift vs. Forward Current

$\lambda_p = \lambda_p(I_f) - \lambda_p(9A)$ , 20 ms pulse,  $T_j = 25^\circ\text{C}$

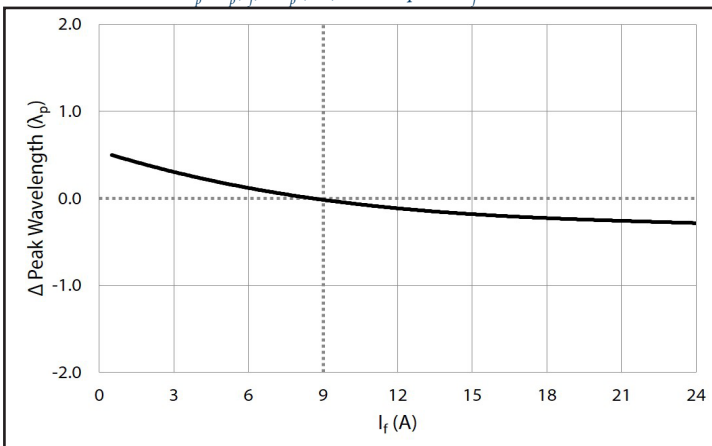

### Peak Wavelength Shift vs. Junction Temperature

$\lambda_p = \lambda_p(T_j) - \lambda_p(25^\circ\text{C})$ , 20 ms pulse,  $I_f = 9A$

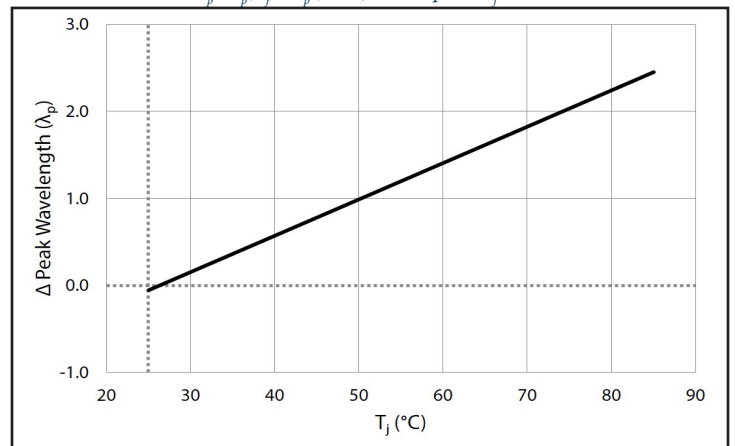

### Forward Voltage vs Forward Current

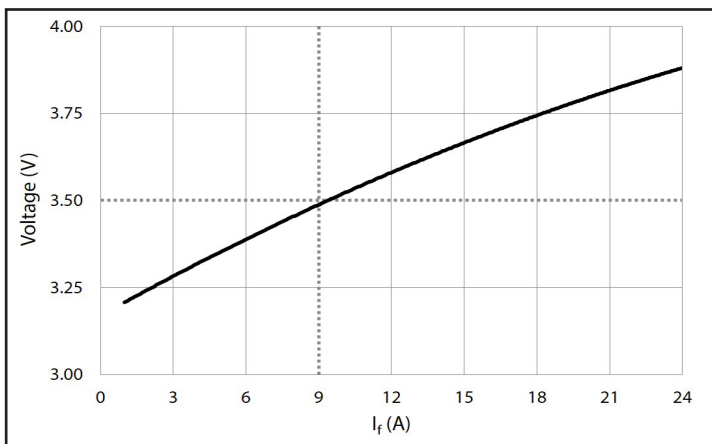

### Forward Voltage Shift vs. Junction Temperature

$\Delta V_f = V_f(T_j) - V_f(25^\circ\text{C})$ , 20 ms pulse,  $I_f = 9A$

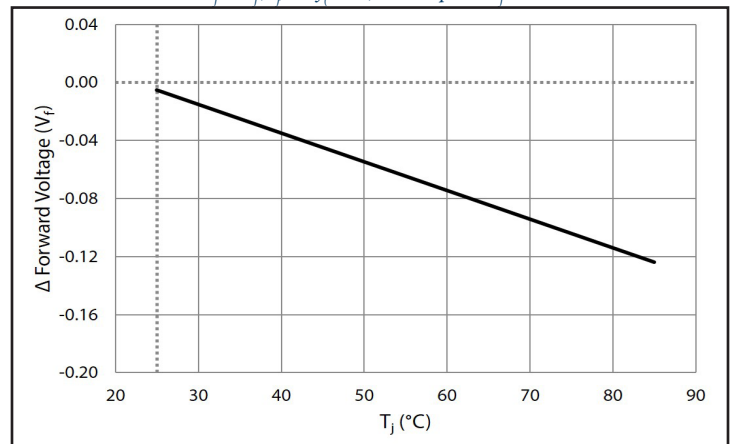

## Optical & Electrical Characteristics- 405 nm

### Relative Power vs. Forward Current

$\phi/\phi_{(9A)}$ , 20 ms pulse,  $T_j = 25^\circ\text{C}$

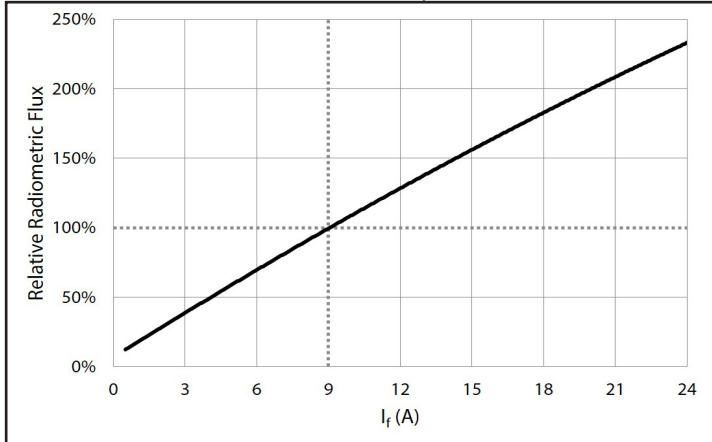

### Relative Power vs. Junction Temperature

$\phi/\phi_{(25^\circ\text{C})}$ , 20 ms pulse, 9A

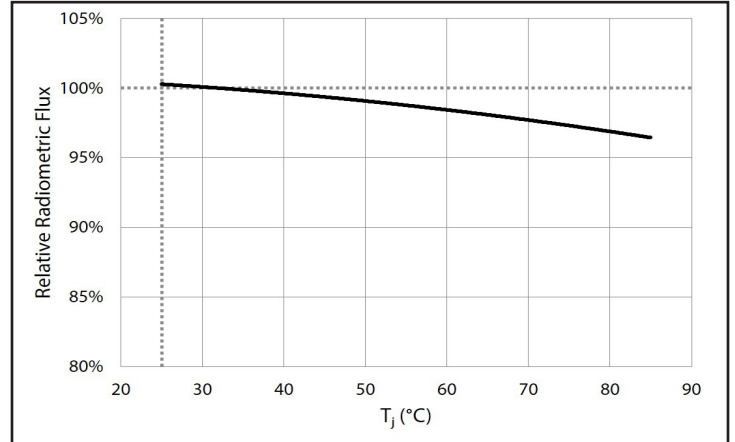

### Peak Wavelength Shift vs. Forward Current

$\lambda_p = \lambda_p(I_f) - \lambda_p(9A)$ , 20 ms pulse,  $T_j = 25^\circ\text{C}$

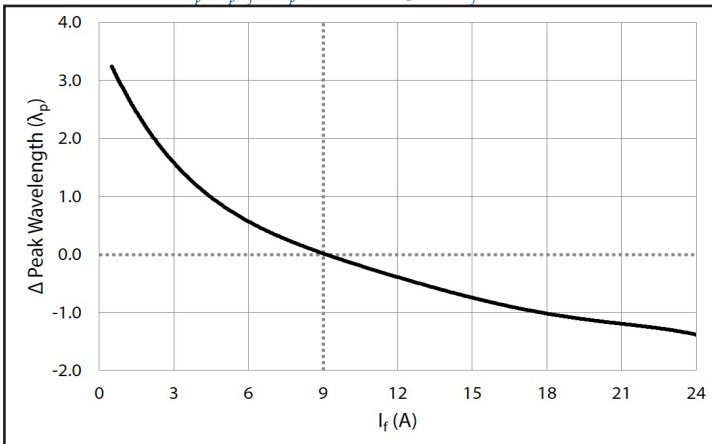

### Peak Wavelength Shift vs. Junction Temperature

$\lambda_p = \lambda_p(T_j) - \lambda_p(25^\circ\text{C})$ , 20 ms pulse,  $I_f = 9A$

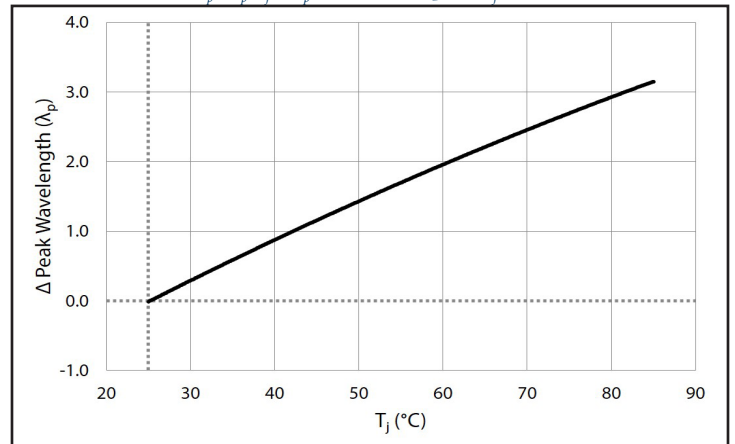

### Forward Voltage vs Forward Current

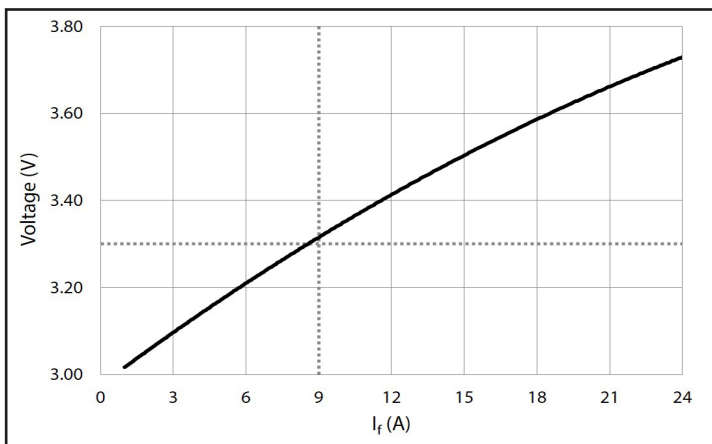

### Forward Voltage Shift vs. Junction Temperature

$\Delta V_f = V_f(T_j) - V_f(25^\circ\text{C})$ , 20 ms pulse,  $I_f = 9A$

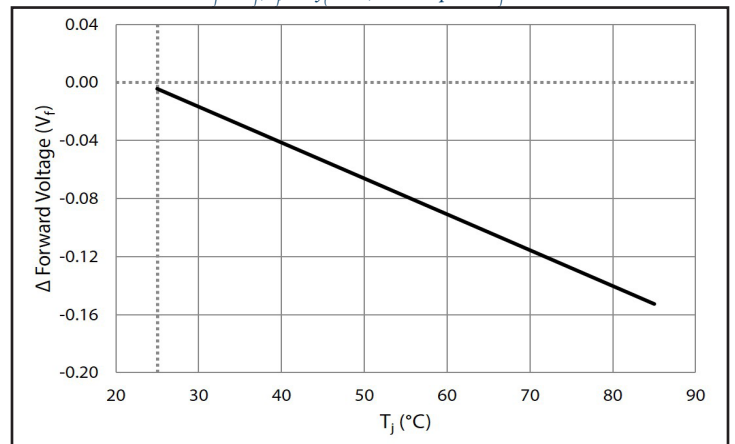



### Typical Spectrum<sup>9</sup>

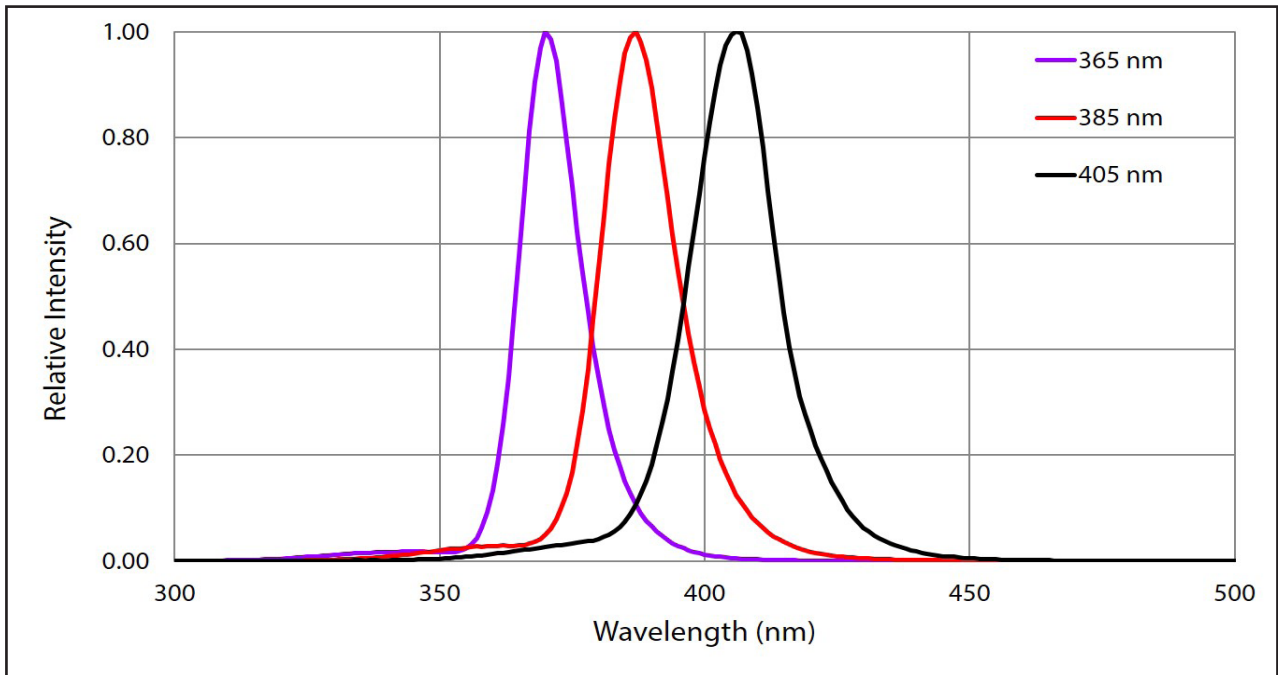

### Radiation Pattern<sup>10</sup>

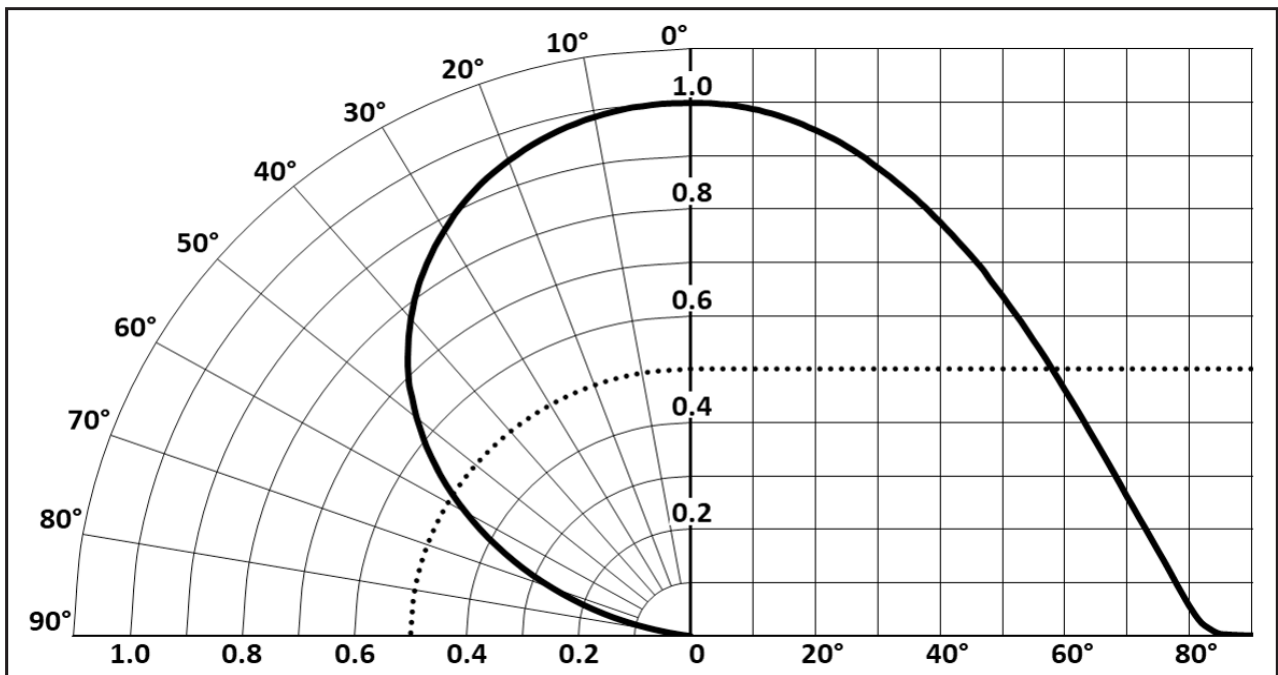

Note 9: Typical spectrum at 9 A drive current.

Note 10: Detailed information on radiation pattern including ray trace files can be found at: <http://www.luminus.com>

## Thermal Resistance

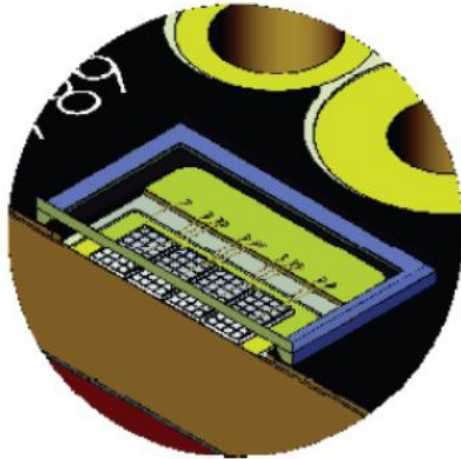

$T_j$  = Die Junction Temp  
 $T_b$  = Coreboard Temp  
 $T_{hs}$  = Heatsink Temp (3mm from surface)  
 $T_{ref}$  - Thermistor Temp

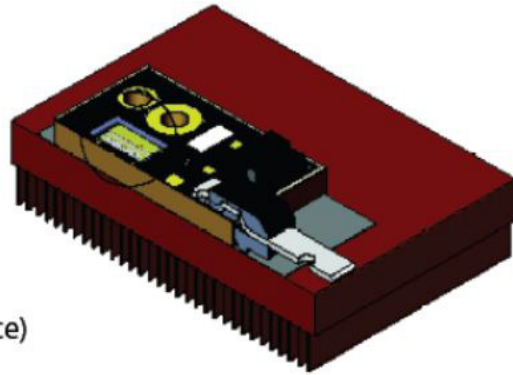

## Thermistor Information

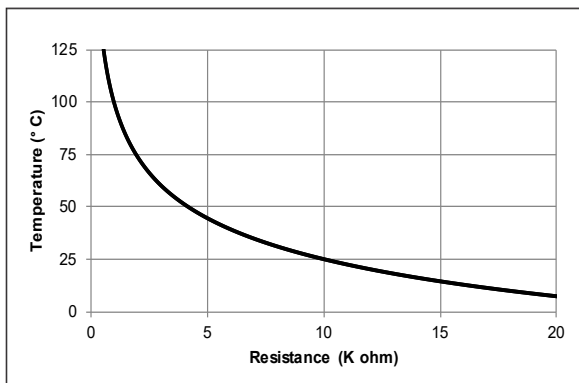

$R_{\theta j-b}^{11}$	0.41 °C/W
$R_{\theta b-hs}$	0.12 °C/W
$R_{\theta j-hs}^{12}$	0.53 °C/W
$R_{\theta j-ref}$	0.31 °C/W

Note 11: Electrical thermal resistance based on input electrical power at 3A and measured per JESD51-14

Note 12: Thermal Resistance is based on eGraf 1205 Thermal interface.

The thermistor mounted CBM-120-UVX coreboards is from Murata Manufacturing Co., part number NCP18XH103J03RB. Please see <http://www.murata.com/> for details on calculating thermistor temperature. Contact Luminus for more information on use of the thermistor.

**Important note: The CBM-120-UVX copper PCB is electrically active with a common cathode polarity.**

## Mechanical Dimensions and Electrical Pin Out

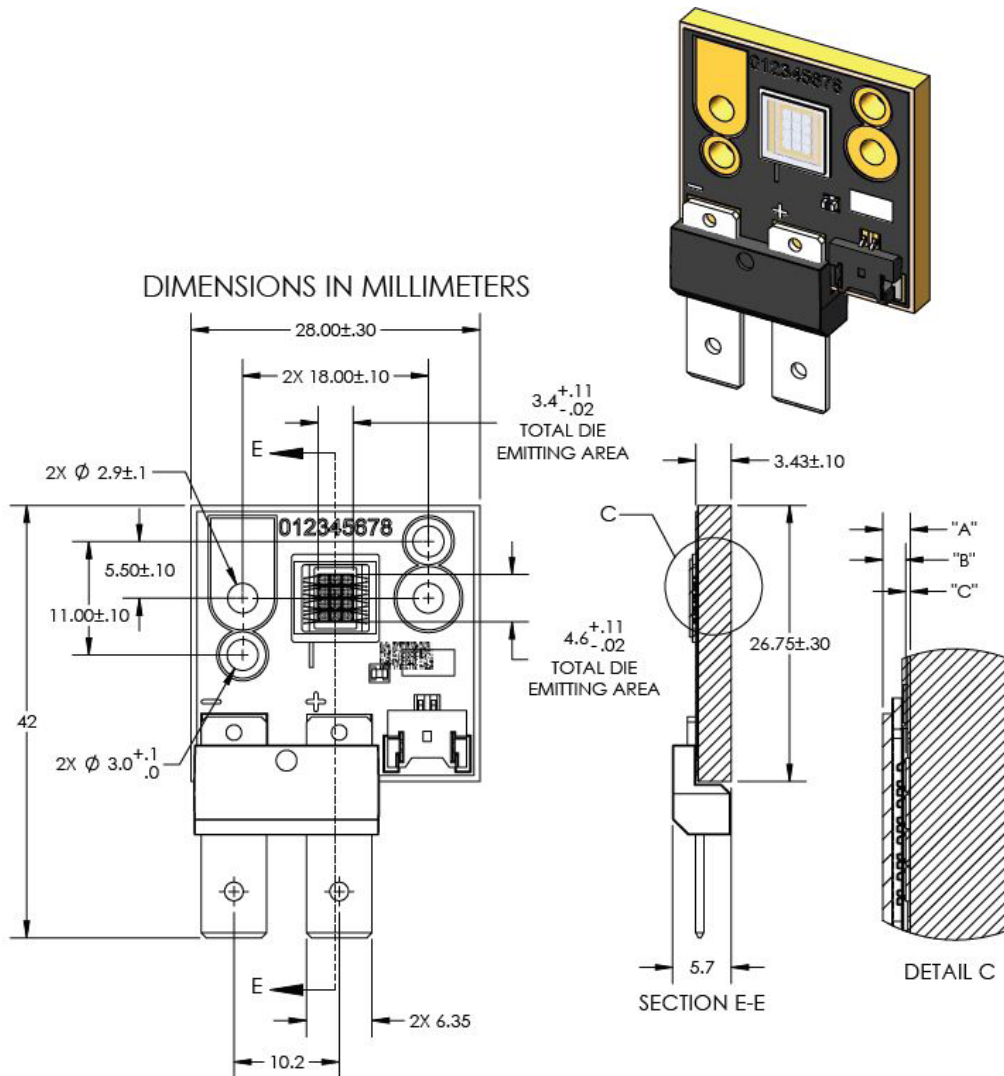

DWG-002934

Recommended connector for Anode and Cathode: Panduit Disco Lok™ Series P/N: DNF14-250FIB or DNF10-250FIB for high current. Check NEC standards for ampacity of the power cable being used.

Thermistor Connector: GCT P/N WTB08-021S-F. Recommended Female: GCT P/N WTB06-020H-A, MOLEX P/N 51146-0200 (Not recommended for new designs), or equivalent.

**Note: The coreboards and windows of LEDs may have minor cosmetic differences, for e.g. slightly different hues, because of different supply sources. These differences are only cosmetic and do not affect form, fit or function of the LED.**

### Shipping Tray Outline

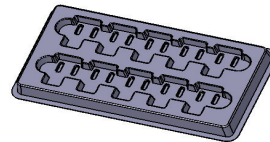
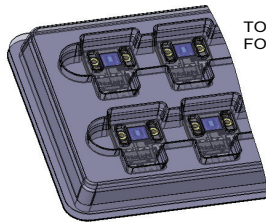
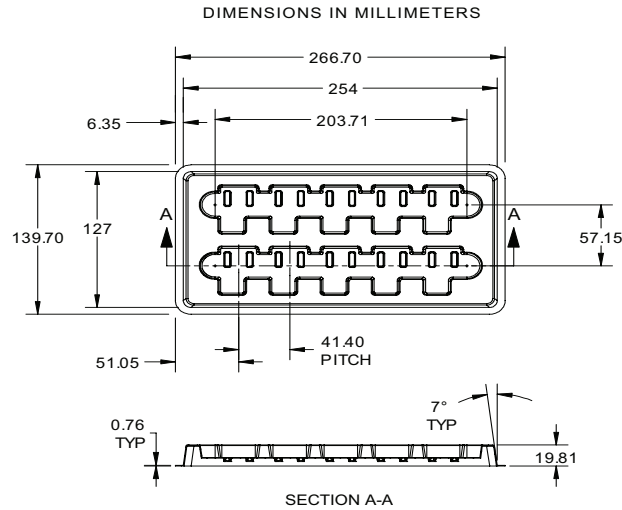

## Packing and Shipping Specifications

Packing Configuration	Qty /Pack	Box Dimensions (diameter x W, mm)	Gross Weight (kg)
Stack of 5 trays with 10 devices per tray Each pack is enclosed in ESD bag	50	140 x 280 x 70	2.7

### Product Label Specification

#### Label Fields (subject to change):

- 6-8 digit Box number (for Luminus internal use)
- Luminus ordering part number
- Quantity of devices in pack
- Part number revision (for Luminus internal use)
- Customer's part number (optional)
- Flux Bin
- 2D Bar code



Sample label –for illustration only

### Shipping Box

Shipping Box	Quantity	Material	Dimensions (L x W x H, mm)
Carton Box	1 -20 packs (50 - 1000 Devices)	S4651	560 x 560 x 200



## Revision History

Rev	Date	Description of Change
01	06/01/2018	Initial Release
02	06/13/2018	Tolerances in Mechanical Dimensions, Emitting Area
03	5/15/2019	Introduced 365 nm, revised Rth j-b, and updated recommended anode/cathode connectors

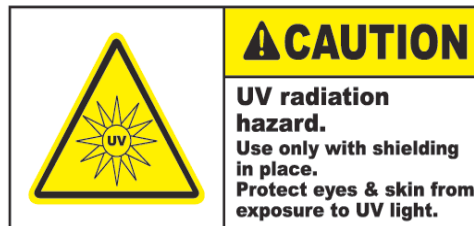

The products, their specifications and other information appearing in this document are subject to change by Luminus Devices without notice. Luminus Devices assumes no liability for errors that may appear in this document, and no liability otherwise arising from the application or use of the product or information contained herein. None of the information provided herein should be considered to be a representation of the fitness or suitability of the product for any particular application or as any other form of warranty. Luminus Devices' product warranties are limited to only such warranties as accompany a purchase contract or purchase order for such products. Nothing herein is to be construed as constituting an additional warranty. No information contained in this publication may be considered as a waiver by Luminus Devices of any intellectual property rights that Luminus Devices may have in such information.

This product is protected by U.S. Patents 6,831,302; 7,074,631; 7,083,993; 7,084,434; 7,098,589; 7,105,861; 7,138,666; 7,166,870; 7,166,871; 7,170,100; 7,196,354; 7,211,831; 7,262,550; 7,274,043; 7,301,271; 7,341,880; 7,344,903; 7,345,416; 7,348,603; 7,388,233; 7,391,059 Patents Pending in the U.S. and other countries.

Компания «Life Electronics» занимается поставками электронных компонентов импортного и отечественного производства от производителей и со складов крупных дистрибьюторов Европы, Америки и Азии.

С конца 2013 года компания активно расширяет линейку поставок компонентов по направлению коаксиальный кабель, кварцевые генераторы и конденсаторы (керамические, пленочные, электролитические), за счёт заключения дистрибьюторских договоров

Мы предлагаем:

- Конкурентоспособные цены и скидки постоянным клиентам.
- Специальные условия для постоянных клиентов.
- Подбор аналогов.
- Поставку компонентов в любых объемах, удовлетворяющих вашим потребностям.
- Приемлемые сроки поставки, возможна ускоренная поставка.
- Доставку товара в любую точку России и стран СНГ.
- Комплексную поставку.
- Работу по проектам и поставку образцов.
- Формирование склада под заказчика.
- Сертификаты соответствия на поставляемую продукцию (по желанию клиента).
- Тестирование поставляемой продукции.
- Поставку компонентов, требующих военную и космическую приемку.
- Входной контроль качества.
- Наличие сертификата ISO.

В составе нашей компании организован Конструкторский отдел, призванный помогать разработчикам, и инженерам.

Конструкторский отдел помогает осуществить:

- Регистрацию проекта у производителя компонентов.
- Техническую поддержку проекта.
- Защиту от снятия компонента с производства.
- Оценку стоимости проекта по компонентам.
- Изготовление тестовой платы монтаж и пусконаладочные работы.



Тел: +7 (812) 336 43 04 (многоканальный)  
Email: [org@lifeelectronics.ru](mailto:org@lifeelectronics.ru)