

## Chip beads

For general signal line

GHz noise countermeasure (general signal line, high-speed signal line)

MMZ-E series (for automotive)



AEC-Q200

## MMZ1005-E type



## FEATURES

- Noise reduction solution for general signal line.
- Compared to the MMZ series, it is a product that increases the SRF to GHz bands and can countermeasure noise at wide frequencies with 1 element.
- Compared to the MMZ series, it can attain high impedance at GHz bands.
- Various frequency characteristics with 4 materials of different features for countermeasures against everything from general signals to high-speed signals.
- Operating temperature range: -55 to +125°C
- Compliant with AEC-Q200

## APPLICATION

- Various ECUs, various modules, car multimedia (telematics).

## PART NUMBER CONSTRUCTION

|             |                                    |               |                                     |                        |                 |               |
|-------------|------------------------------------|---------------|-------------------------------------|------------------------|-----------------|---------------|
| MMZ         | 1005                               | S             | 601                                 | E                      | T               | D25           |
| Series name | LxWxT dimensions<br>1.0x0.5x0.5 mm | Material name | Impedance<br>( $\Omega$ ) at 100MHz | Characteristic<br>type | Packaging style | Internal code |

## CHARACTERISTICS SPECIFICATION TABLE

| Impedance<br>[100MHz] |           | [1GHz]       |           | DC resistance    | Rated current | Part No.                         |
|-----------------------|-----------|--------------|-----------|------------------|---------------|----------------------------------|
| ( $\Omega$ )          | Tolerance | ( $\Omega$ ) | Tolerance | ( $\Omega$ )max. | (mA)max.      |                                  |
| 600                   | ±25%      | 1000         | ±40%      | 0.65             | 300           | <a href="#">MMZ1005S601ETD25</a> |
| 1000                  | ±25%      | 1400         | ±40%      | 1.00             | 250           | <a href="#">MMZ1005S102ETD25</a> |
| 1800                  | ±25%      | 1800         | ±40%      | 1.50             | 200           | <a href="#">MMZ1005S182ETD25</a> |
| 600                   | ±25%      | 1400         | ±40%      | 0.80             | 300           | <a href="#">MMZ1005A601ETD25</a> |
| 1000                  | ±25%      | 2000         | ±40%      | 1.20             | 250           | <a href="#">MMZ1005A102ETD25</a> |
| 1500                  | ±25%      | 2300         | ±40%      | 1.60             | 230           | <a href="#">MMZ1005A152ETD25</a> |
| 1800                  | ±25%      | 2700         | ±40%      | 2.10             | 200           | <a href="#">MMZ1005A182ETD25</a> |
| 2200                  | ±25%      | 3000         | ±40%      | 2.20             | 150           | <a href="#">MMZ1005A222ETD25</a> |
| 120                   | ±25%      | 1000         | ±40%      | 0.70             | 300           | <a href="#">MMZ1005D121ETD25</a> |
| 220                   | ±25%      | 1700         | ±40%      | 1.00             | 250           | <a href="#">MMZ1005D221ETD25</a> |
| 47                    | ±25%      | 800          | ±40%      | 0.70             | 300           | <a href="#">MMZ1005F470ETD25</a> |
| 75                    | ±25%      | 1500         | ±40%      | 1.00             | 250           | <a href="#">MMZ1005F750ETD25</a> |
| 120                   | ±25%      | 2300         | ±40%      | 1.50             | 200           | <a href="#">MMZ1005F121ETD25</a> |
| 180                   | ±25%      | 3200         | ±40%      | 1.60             | 200           | <a href="#">MMZ1005F181ETD25</a> |
| 220                   | ±25%      | 5000         | ±40%      | 2.30             | 150           | <a href="#">MMZ1005F221ETD25</a> |

Measurement equipment

| Measurement item | Product No.   | Manufacturer          |
|------------------|---------------|-----------------------|
| Impedance        | E4991A+16192A | Keysight Technologies |
| DC resistance    | Type-7556     | Yokogawa              |

\* Equivalent measurement equipment may be used.

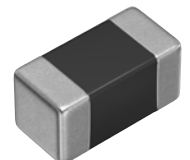

# MMZ1005-E type

## Z VS. FREQUENCY CHARACTERISTICS (BY SERIES)

**MMZ1005S-E series**



**MMZ1005A-E series**

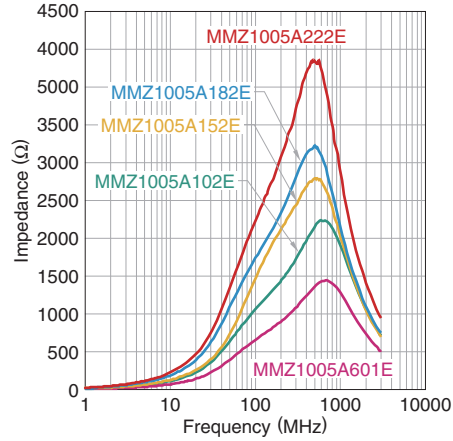

**MMZ1005D-E series**

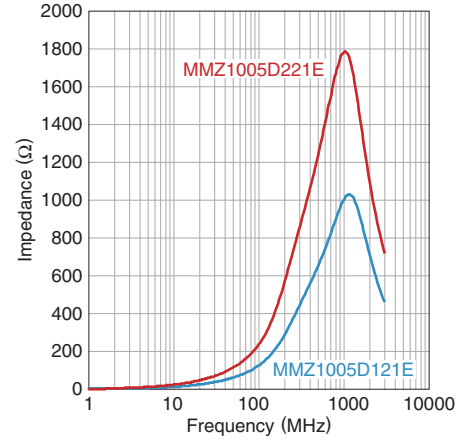

**MMZ1005F-E series**

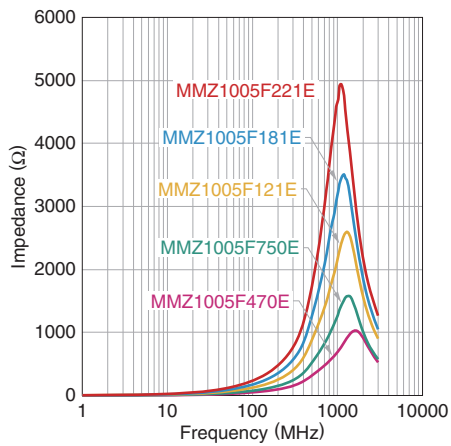

# MMZ1005-E type

## Z, X, R VS. FREQUENCY CHARACTERISTICS

**MMZ1005S601ETD25**

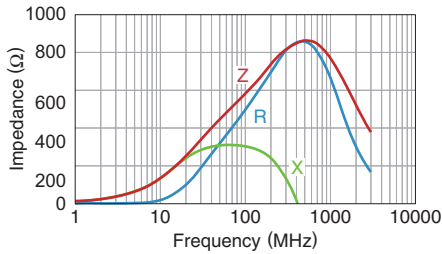

**MMZ1005S102ETD25**

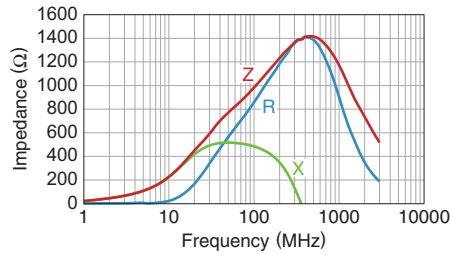

**MMZ1005S182ETD25**

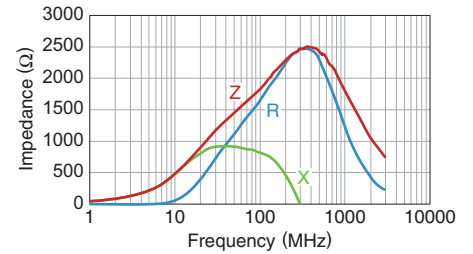

**MMZ1005A601ETD25**

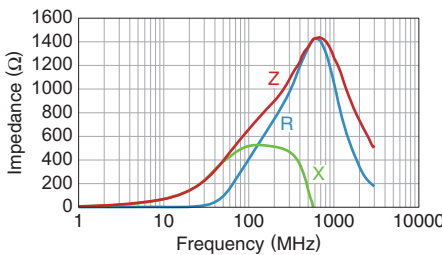

**MMZ1005A102ETD25**

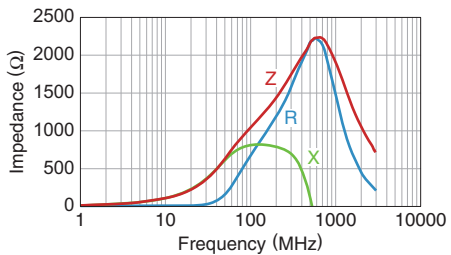

**MMZ1005A152ETD25**

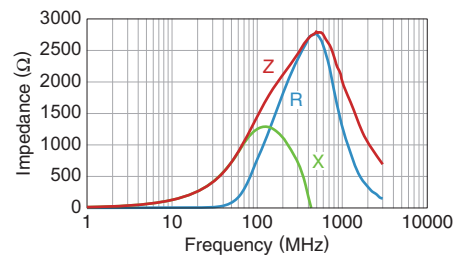

**MMZ1005A182ETD25**

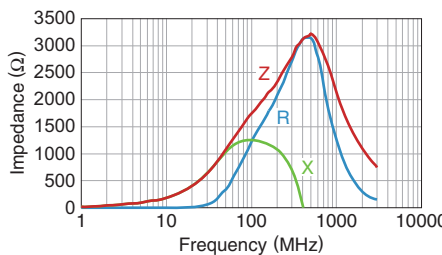

**MMZ1005A222ETD25**

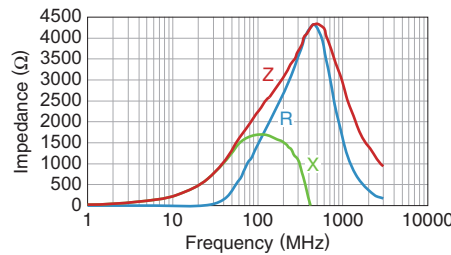

**MMZ1005D121ETD25**

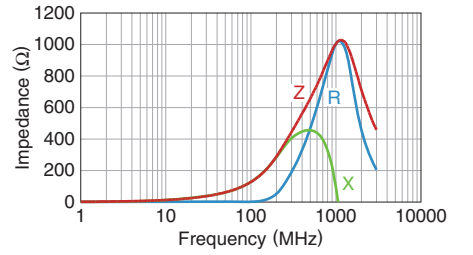

**MMZ1005D221ETD25**

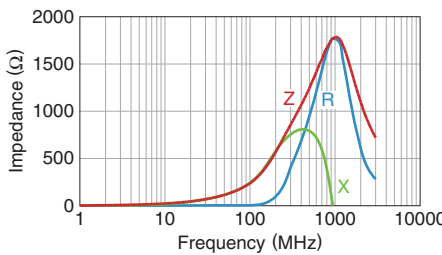

**MMZ1005F470ETD25**

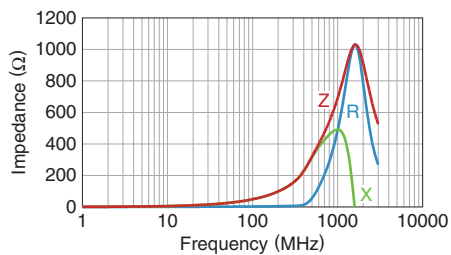

**MMZ1005F750ETD25**

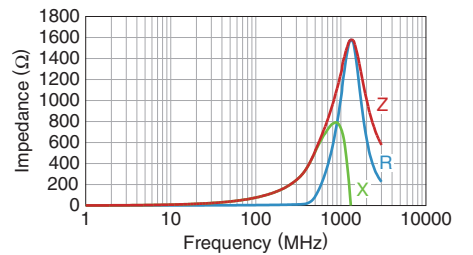

**MMZ1005F121ETD25**

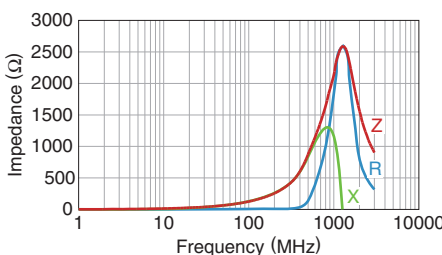

**MMZ1005F181ETD25**

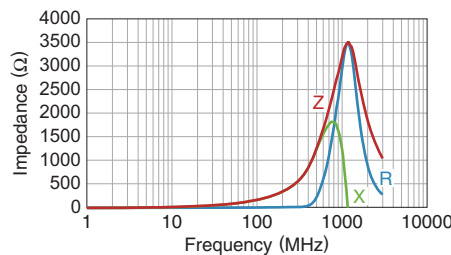

**MMZ1005F221ETD25**

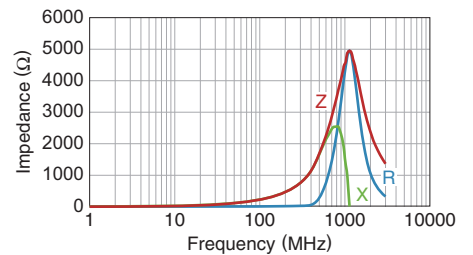

⚠ Please be sure to request delivery specifications that provide further details on the features and specifications of the products for proper and safe use. (3/5)  
Please note that the contents may change without any prior notice due to reasons such as upgrading.

# MMZ1005-E type

## SHAPE & DIMENSIONS

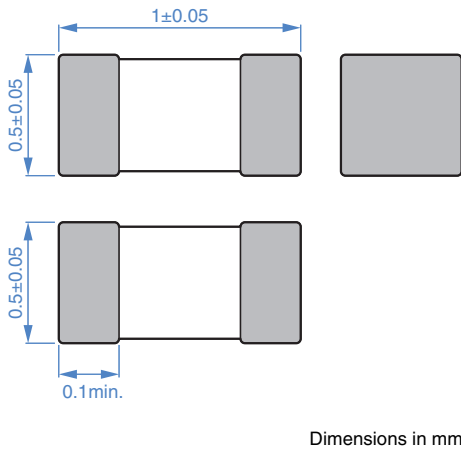

## PACKAGING STYLE

### REEL DIMENSIONS

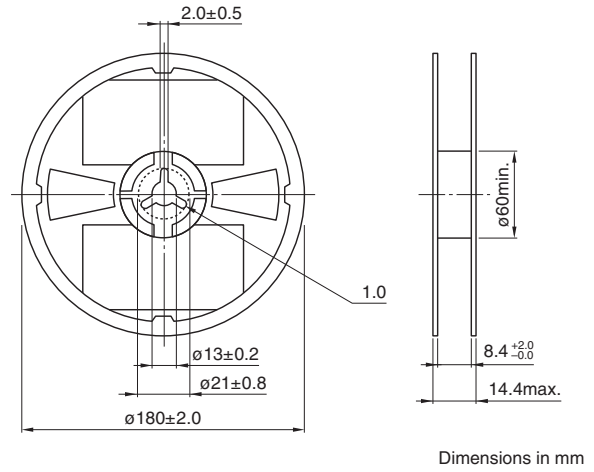

## RECOMMENDED LAND PATTERN

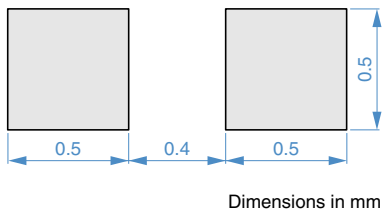

### TAPE DIMENSIONS



## RECOMMENDED REFLOW PROFILE

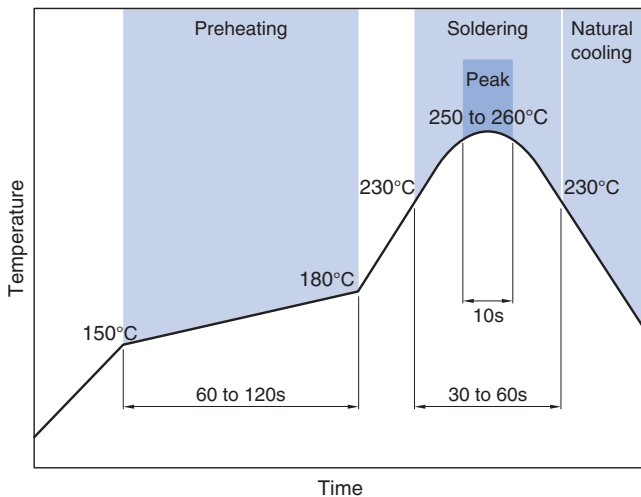

| Type      | A        | B        | K       |
|-----------|----------|----------|---------|
| MMZ1005-E | 0.65±0.1 | 1.15±0.1 | 0.8max. |



### PACKAGE QUANTITY

|                  |                 |
|------------------|-----------------|
| Package quantity | 10,000 pcs/reel |
|------------------|-----------------|

### TEMPERATURE RANGE, INDIVIDUAL WEIGHT

| Operating temperature range | Storage temperature range* | Individual weight |
|-----------------------------|----------------------------|-------------------|
| -55 to +125°C               | -55 to +125°C              | 1 mg              |

\* The storage temperature range is for after the assembly.

## REMINDERS FOR USING THESE PRODUCTS

Before using these products, be sure to request the delivery specifications.

### SAFETY REMINDERS

Please pay sufficient attention to the warnings for safe designing when using this products.

#### REMINDERS

- The storage period is within 12 months. Be sure to follow the storage conditions (temperature: 5 to 40°C, humidity: 10 to 75% RH or less).  
If the storage period elapses, the soldering of the terminal electrodes may deteriorate.
- Do not use or store in locations where there are conditions such as gas corrosion (salt, acid, alkali, etc.).
- Before soldering, be sure to preheat components.  
The preheating temperature should be set so that the temperature difference between the solder temperature and chip temperature does not exceed 150°C.
- Soldering corrections after mounting should be within the range of the conditions determined in the specifications.  
If overheated, a short circuit, performance deterioration, or lifespan shortening may occur.
- When embedding a printed circuit board where a chip is mounted to a set, be sure that residual stress is not given to the chip due to the overall distortion of the printed circuit board and partial distortion such as at screw tightening portions.
- Self heating (temperature increase) occurs when the power is turned ON, so the tolerance should be sufficient for the set thermal design.
- Carefully lay out the coil for the circuit board design of the non-magnetic shield type.  
A malfunction may occur due to magnetic interference.
- Use a wrist band to discharge static electricity in your body through the grounding wire.
- Do not expose the products to magnets or magnetic fields.
- Do not use for a purpose outside of the contents regulated in the delivery specifications.
- The products listed on this catalog are intended for use in general electronic equipment (AV equipment, telecommunications equipment, home appliances, amusement equipment, computer equipment, personal equipment, office equipment, measurement equipment, industrial robots) under a normal operation and use condition.  
The products are not designed or warranted to meet the requirements of the applications listed below, whose performance and/or quality require a more stringent level of safety or reliability, or whose failure, malfunction or trouble could cause serious damage to society, person or property.  
If you intend to use the products in the applications listed below or if you have special requirements exceeding the range or conditions set forth in the each catalog, please contact us.

- (1) Aerospace/aviation equipment
- (2) Transportation equipment (electric trains, ships, etc.)
- (3) Medical equipment
- (4) Power-generation control equipment
- (5) Atomic energy-related equipment
- (6) Seabed equipment
- (7) Transportation control equipment

- (8) Public information-processing equipment
- (9) Military equipment
- (10) Electric heating apparatus, burning equipment
- (11) Disaster prevention/crime prevention equipment
- (12) Safety equipment
- (13) Other applications that are not considered general-purpose applications

When designing your equipment even for general-purpose applications, you are kindly requested to take into consideration securing protection circuit/device or providing backup circuits in your equipment.

Компания «Life Electronics» занимается поставками электронных компонентов импортного и отечественного производства от производителей и со складов крупных дистрибьюторов Европы, Америки и Азии.

С конца 2013 года компания активно расширяет линейку поставок компонентов по направлению коаксиальный кабель, кварцевые генераторы и конденсаторы (керамические, пленочные, электролитические), за счёт заключения дистрибьюторских договоров

Мы предлагаем:

- Конкуренеспособные цены и скидки постоянным клиентам.
- Специальные условия для постоянных клиентов.
- Подбор аналогов.
- Поставку компонентов в любых объемах, удовлетворяющих вашим потребностям.
- Приемлемые сроки поставки, возможна ускоренная поставка.
- Доставку товара в любую точку России и стран СНГ.
- Комплексную поставку.
- Работу по проектам и поставку образцов.
- Формирование склада под заказчика.
- Сертификаты соответствия на поставляемую продукцию (по желанию клиента).
- Тестирование поставляемой продукции.
- Поставку компонентов, требующих военную и космическую приемку.
- Входной контроль качества.
- Наличие сертификата ISO.

В составе нашей компании организован Конструкторский отдел, призванный помогать разработчикам, и инженерам.

Конструкторский отдел помогает осуществить:

- Регистрацию проекта у производителя компонентов.
- Техническую поддержку проекта.
- Защиту от снятия компонента с производства.
- Оценку стоимости проекта по компонентам.
- Изготовление тестовой платы монтаж и пусконаладочные работы.



Тел: +7 (812) 336 43 04 (многоканальный)

Email: [org@lifeelectronics.ru](mailto:org@lifeelectronics.ru)