

FEATURES

Conversion loss: 9 dB typical
LO to RF isolation: 40 dB typical
LO to IF isolation: 35 dB typical
RF to IF isolation: 22 dB typical
Input IP3: 18 dBm typical
Input P1dB: 11 dBm typical
Input IP2: 55 dBm typical
Passive double balanced topology
8-lead, 3 mm × 3 mm, MINI_SO_EP

APPLICATIONS

Microwave radios
**High performance radio local area network (HiperLAN) and
unlicensed national information infrastructure (U-NII)**
Industrial, scientific, and medical (ISM)

GENERAL DESCRIPTION

The **HMC219B** is an ultraminiature, general-purpose, double balanced mixer in an 8-lead plastic surface mini small outline package with exposed pad (MINI_SO_EP). This passive monolithic microwave integrated circuit (MMIC) mixer is fabricated in a gallium arsenide (GaAs) metal semiconductor field effect transistor (MESFET) process and requires no external components or matching circuitry. The device can be used as an upconverter, downconverter, biphase demodulator, or phase comparator from 2.5 GHz to 7.0 GHz.

FUNCTIONAL BLOCK DIAGRAM

Figure 1.

The **HMC219B** provides excellent local oscillator (LO) to radio frequency (RF) isolation and LO to intermediate frequency (IF) isolation due to optimized balun structures. The RoHS compliant **HMC219B** eliminates the need for wire bonding and is compatible with high volume surface-mount manufacturing techniques. The consistent MMIC performance improves system operation and assures regulatory compliance with HiperLAN, U-NII, and ISM.

TABLE OF CONTENTS

Features	1	Typical Performance Characteristics	6
Applications	1	Downconverter Performance	6
Functional Block Diagram	1	Upconverter Performance	18
General Description	1	Spurious and Harmonics Performance	24
Revision History	2	Theory of Operation	25
Specifications	3	Applications Information	26
Absolute Maximum Ratings	4	Typical Application Circuit	26
Thermal Resistance	4	Evaluation PCB Information	26
ESD Caution	4	Outline Dimensions	27
Pin Configuration and Function Descriptions	5	Ordering Guide	27
Interface Schematics	5		

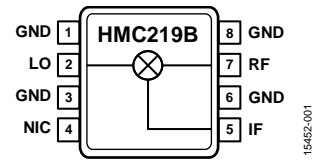
REVISION HISTORY

10/2017—Rev. 0 to Rev. A

Changes to Figure 16	7
Changes to M × N Spurious Outputs, IF = 100 MHz Section and M × N Spurious Outputs, IF = 1000 MHz Section	24

1/2017—Revision 0: Initial Version

SPECIFICATIONS

$T_A = 25^\circ\text{C}$, IF = 100 MHz, LO power = 13 dBm, and all measurements performed as downconverter with lower sideband selected, unless otherwise noted.

Table 1.

Parameter	Min	Typ	Max	Unit
FREQUENCY RANGE				
RF	2.5		7.0	GHz
LO	2.5		7.0	GHz
IF	DC		3	GHz
LO DRIVE LEVEL				
		13		dBm
PERFORMANCE				
Conversion Loss		9	11	dB
Single-Sideband (SSB) Noise Figure		8		dB
Input Third-Order Intercept (IP3)	15	18		dBm
Input Second-Order Intercept (IP2)		55		dBm
LO to RF Isolation	34	40		dB
LO to IF Isolation	29	35		dB
RF to IF Isolation		22		dB
Input 1 dB Compression Point (P1dB)		11		dBm
RF Return Loss		10		dB
LO Return Loss		25		dB
IF Return Loss		12		dB

ABSOLUTE MAXIMUM RATINGS

Table 2.

Parameter	Rating
RF Input Power	25 dBm
LO Input Power	27dBm
IF Input Power	25 dBm
IF Source and Sink Current	6 mA
Continuous Power Dissipation, P_{DISS} ($T_A = 85^\circ\text{C}$, Derate 10.81 mW/ $^\circ\text{C}$ Above 85°C)	972 mW
Maximum Junction Temperature	175°C
Maximum Peak Reflow Temperature (MSL1) ¹	260°C
Operating Temperature Range	-40°C to $+85^\circ\text{C}$
Storage Temperature Range	-65°C to $+125^\circ\text{C}$
Electrostatic Discharge (ESD) Sensitivity	
Human Body Model (HBM)	1500 V (Class 1C)
Field Induced Charged Device Model (FICDM)	750 V (Class C4)

¹ See the Ordering Guide.

Stresses at or above those listed under Absolute Maximum Ratings may cause permanent damage to the product. This is a stress rating only; functional operation of the product at these or any other conditions above those indicated in the operational section of this specification is not implied. Operation beyond the maximum operating conditions for extended periods may affect product reliability.

THERMAL RESISTANCE

Thermal performance is directly linked to printed circuit board (PCB) design and operating environment. Careful attention to PCB thermal design is required.

Table 3. Thermal Resistance

Package Type	θ_{JA}	θ_{JC}	Unit
RM-8	194.9	92.5	$^\circ\text{C}/\text{W}$

¹ See JEDEC standard JESD51-2 for additional information on optimizing the thermal impedance (PCB with 3×3 vias).

ESD CAUTION



ESD (electrostatic discharge) sensitive device. Charged devices and circuit boards can discharge without detection. Although this product features patented or proprietary protection circuitry, damage may occur on devices subjected to high energy ESD. Therefore, proper ESD precautions should be taken to avoid performance degradation or loss of functionality.

PIN CONFIGURATION AND FUNCTION DESCRIPTIONS

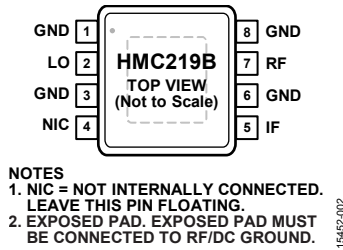

Figure 2. Pin Configuration

Table 4. Pin Function Descriptions

Pin No.	Mnemonic	Description
1, 3, 6, 8	GND	Ground. Connect the package bottom to RF/dc ground. See Figure 3 for the GND interface schematic.
2	LO	Local Oscillator. This pin is dc-coupled and matched to 50 Ω. See Figure 4 for the LO interface schematic.
4	NIC	Not Internally Connected. Leave this pin floating.
5	IF	Intermediate Frequency. This pin is dc-coupled. For applications not requiring operation to dc, externally block this pin using a series capacitor with a value chosen to pass the necessary IF frequency range. For operation to dc, this pin must not source or sink more than 6 mA of current or device nonfunction and possible device failure results. See Figure 5 for the IF interface schematic.
7	RF	Radio Frequency. This pin is dc-coupled and matched to 50 Ω. See Figure 6 for the RF interface schematic.

INTERFACE SCHEMATICS



Figure 3. GND Interface Schematic

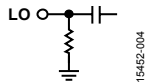

Figure 4. LO Interface Schematic

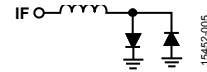

Figure 5. IF Interface Schematic

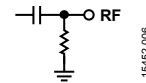

Figure 6. RF Interface Schematic

TYPICAL PERFORMANCE CHARACTERISTICS

DOWNCONVERTER PERFORMANCE

Data taken as downconverter, lower sideband, $T_A = 25^\circ\text{C}$, $\text{IF} = 100\text{ MHz}$, and $\text{LO power} = 13\text{ dBm}$, unless otherwise noted.

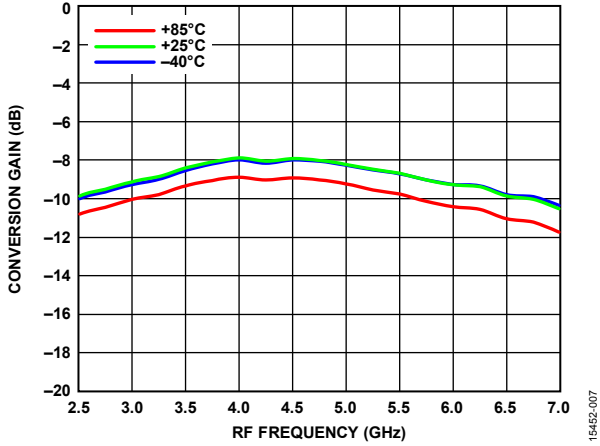

Figure 7. Conversion Gain vs. RF Frequency at Various Temperatures

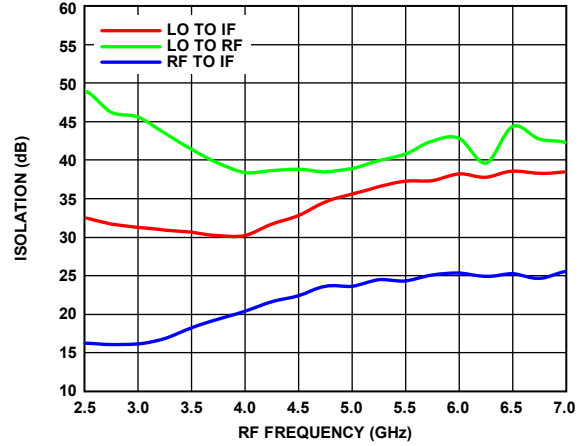

Figure 10. Isolation vs. RF Frequency

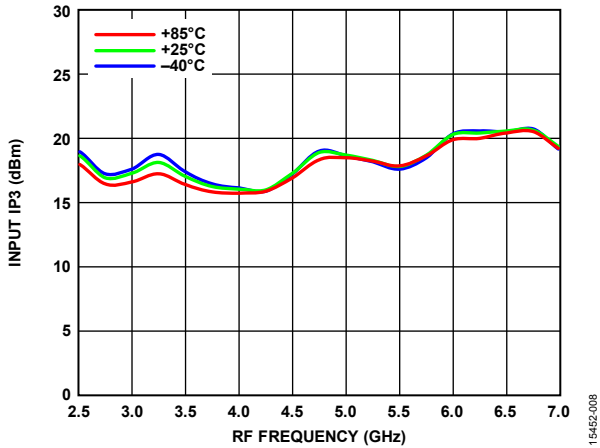

Figure 8. Input IP3 vs. RF Frequency at Various Temperatures

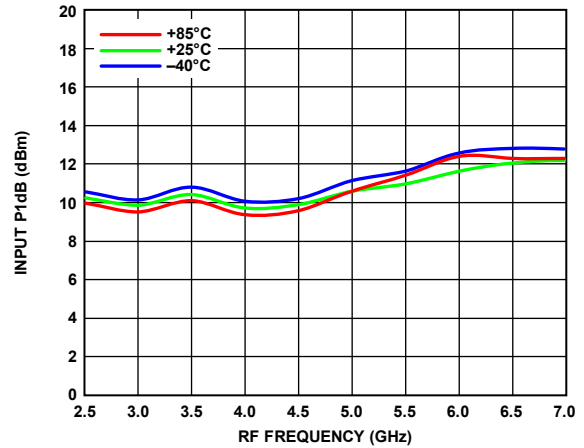

Figure 11. Input P1dB vs. RF Frequency at Various Temperatures

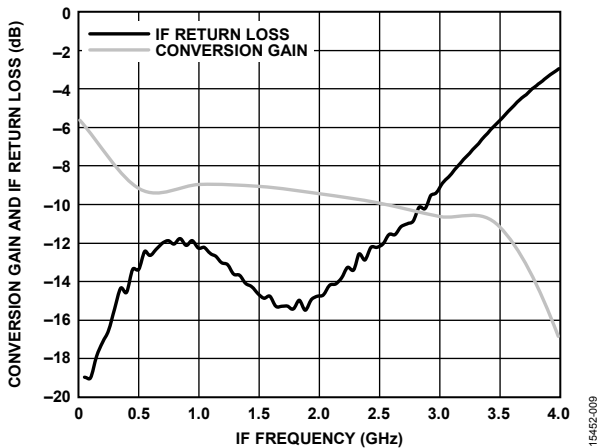

Figure 9. Conversion Gain and IF Return Loss vs. IF Frequency

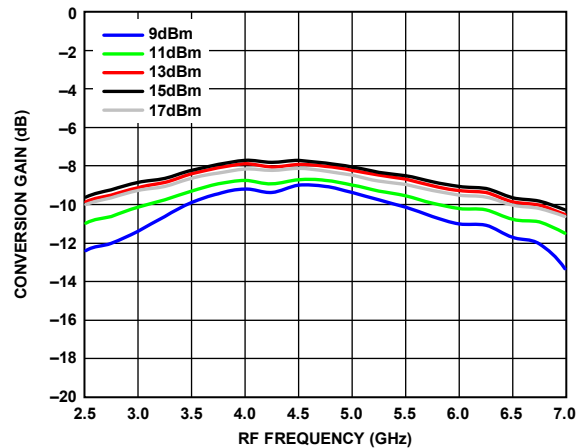

Figure 12. Conversion Gain vs. RF Frequency at Various LO Powers

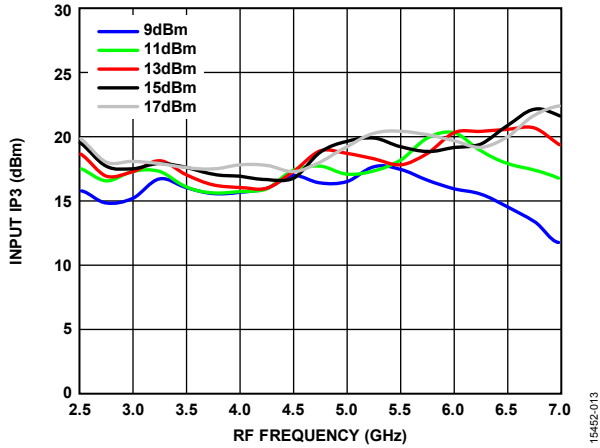

Figure 13. Input IP3 vs. RF Frequency at Various LO Powers

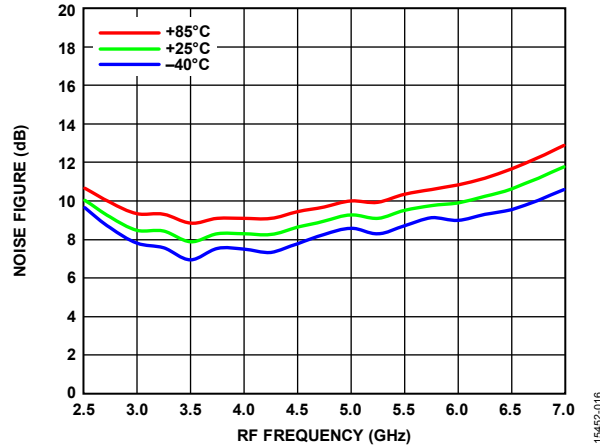

Figure 16. Noise Figure vs. RF Frequency at Various Temperatures

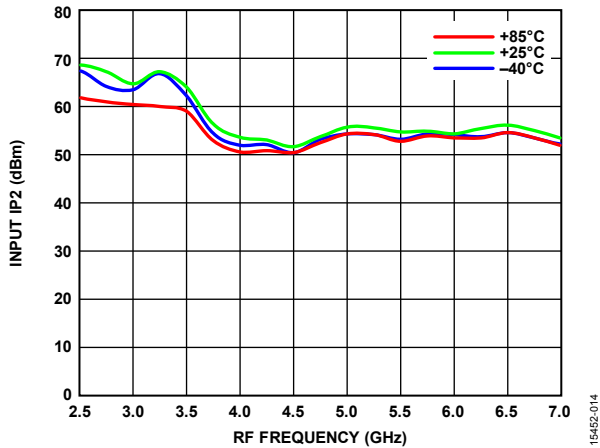

Figure 14. Input IP2 vs. RF Frequency at Various Temperatures

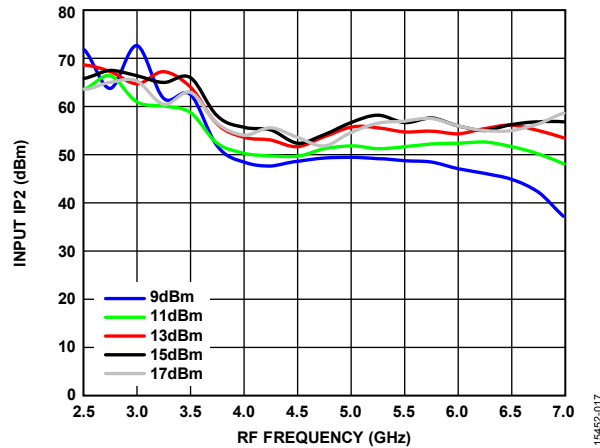

Figure 17. Input IP2 vs. RF Frequency at Various LO Powers

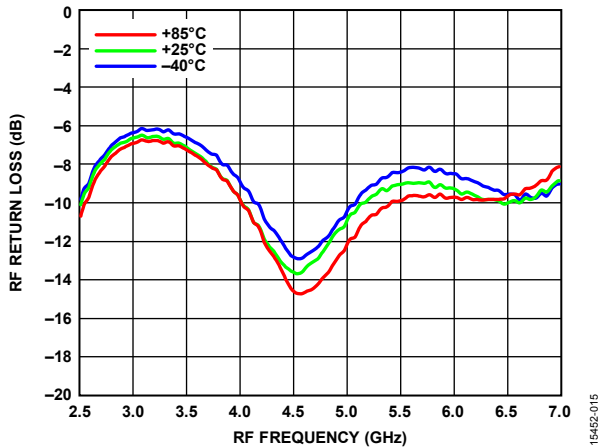

Figure 15. RF Return Loss vs. RF Frequency at Various Temperatures, LO Frequency = 4.6 GHz, LO Power = 13 dBm

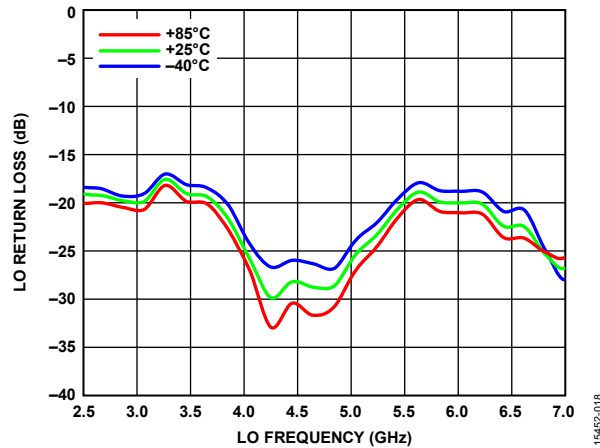

Figure 18. LO Return Loss vs. LO Frequency at Various Temperatures

Data taken as downconverter, lower sideband, $T_A = 25^\circ\text{C}$, $IF = 1000\text{ MHz}$, and $LO\text{ power} = 13\text{ dBm}$, unless otherwise noted.

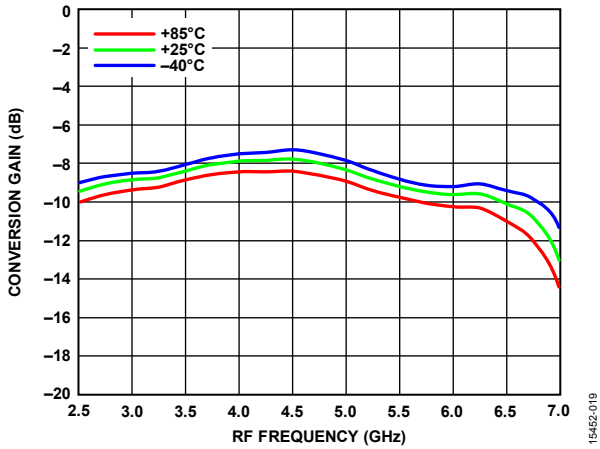

Figure 19. Conversion Gain vs. RF Frequency at Various Temperatures

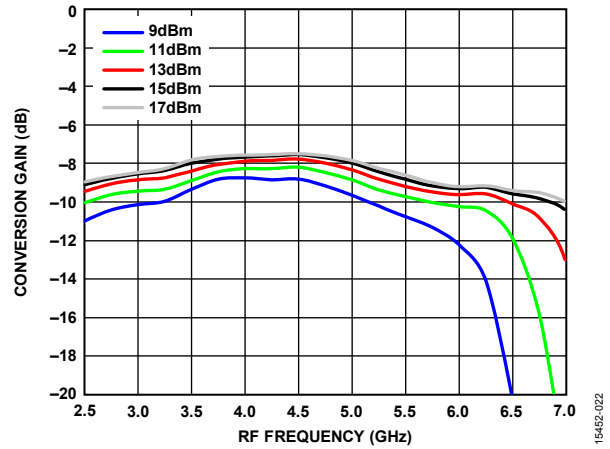

Figure 22. Conversion Gain vs. RF Frequency at Various LO Powers

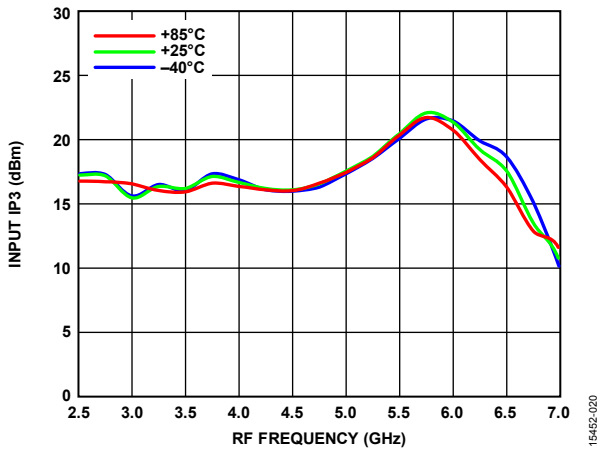

Figure 20. Input IP3 vs. RF Frequency at Various Temperatures

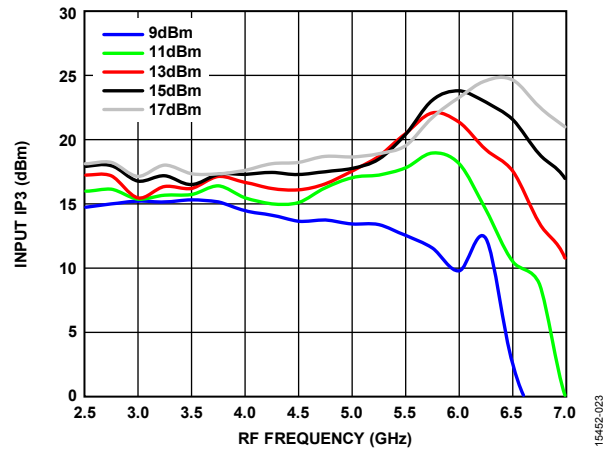

Figure 23. Input IP3 vs. RF Frequency at Various LO Powers

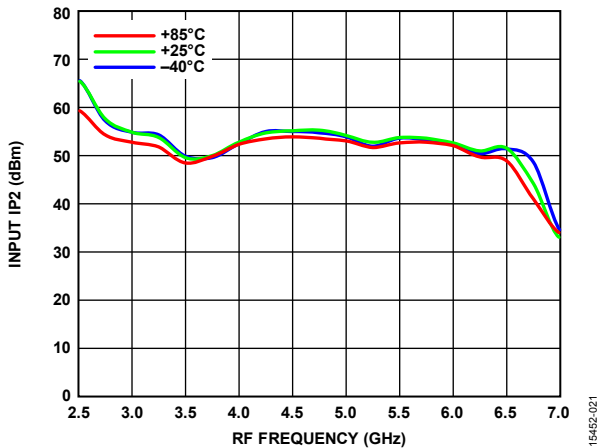

Figure 21. Input IP2 vs. RF Frequency at Various Temperatures

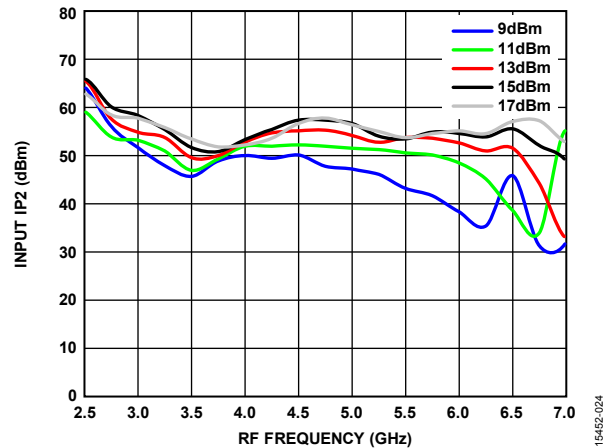

Figure 24. Input IP2 vs. RF Frequency at Various LO Powers

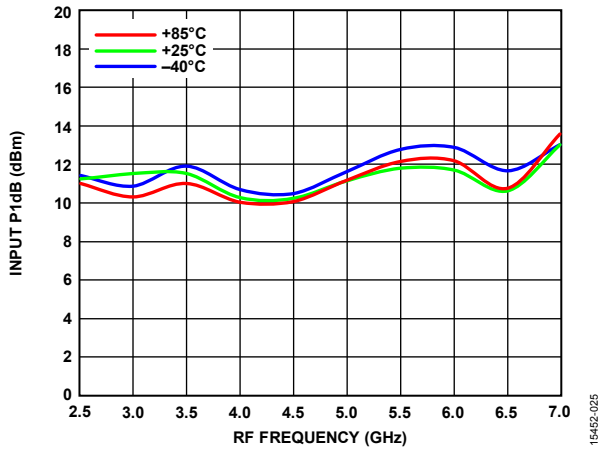

Figure 25. Input P1dB vs. RF Frequency at Various Temperatures

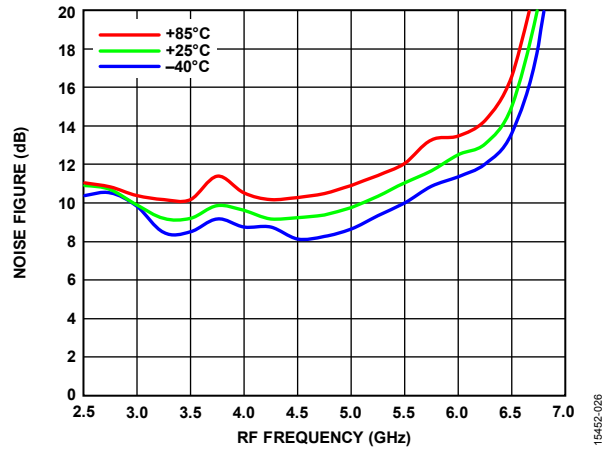

Figure 26. Noise Figure vs. RF Frequency at Various Temperatures

Data taken as downconverter, lower sideband, $T_A = 25^\circ\text{C}$, $\text{IF} = 2000\text{ MHz}$, and $\text{LO power} = 13\text{ dBm}$, unless otherwise noted.

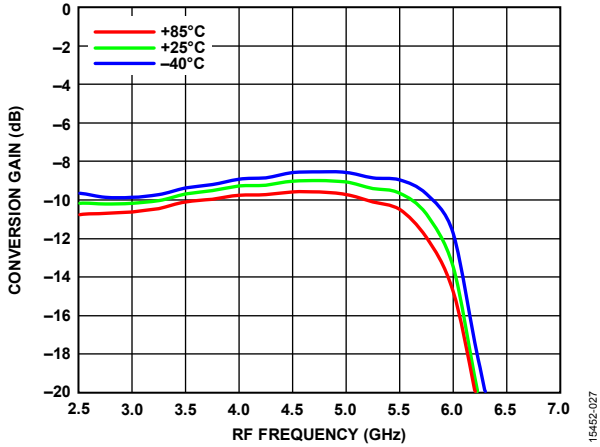

Figure 27. Conversion Gain vs. RF Frequency at Various Temperatures

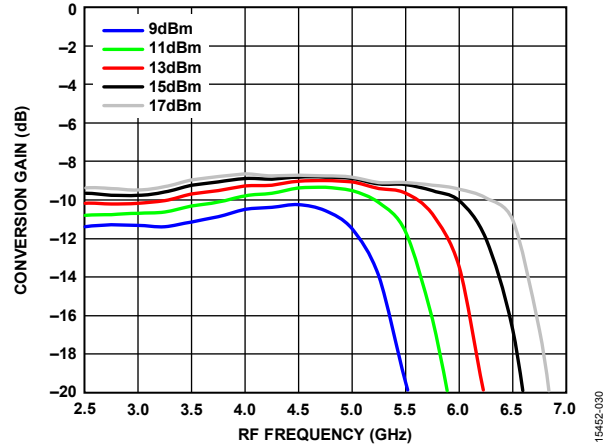

Figure 30. Conversion Gain vs. RF Frequency at Various LO Powers

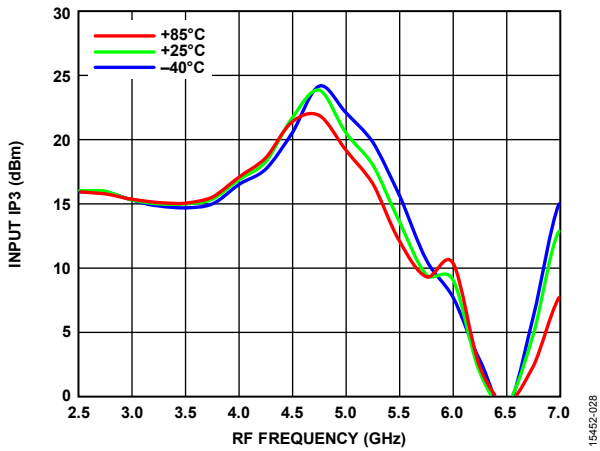

Figure 28. Input IP3 vs. RF Frequency at Various Temperatures

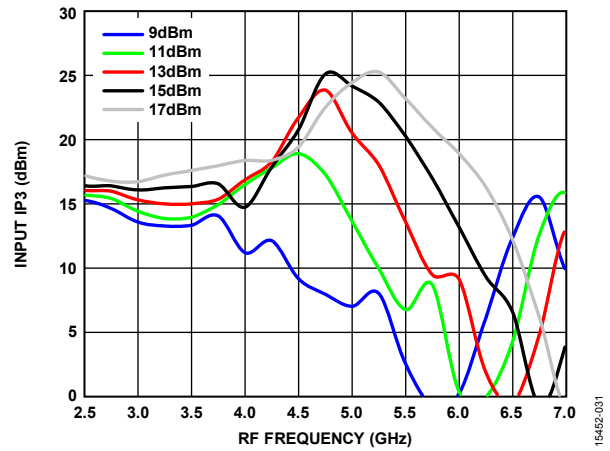

Figure 31. Input IP3 vs. RF Frequency at Various LO Powers

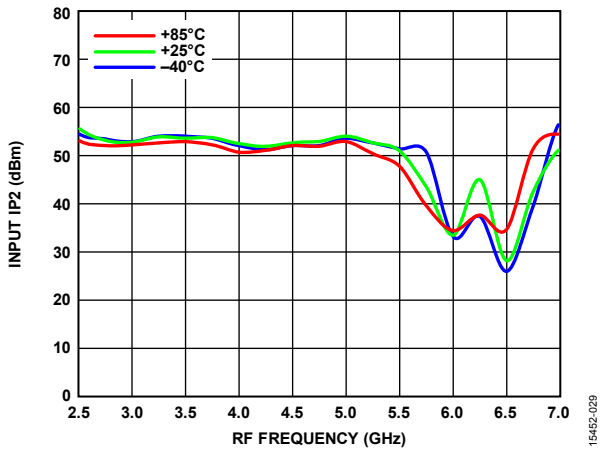

Figure 29. Input IP2 vs. RF Frequency at Various Temperatures

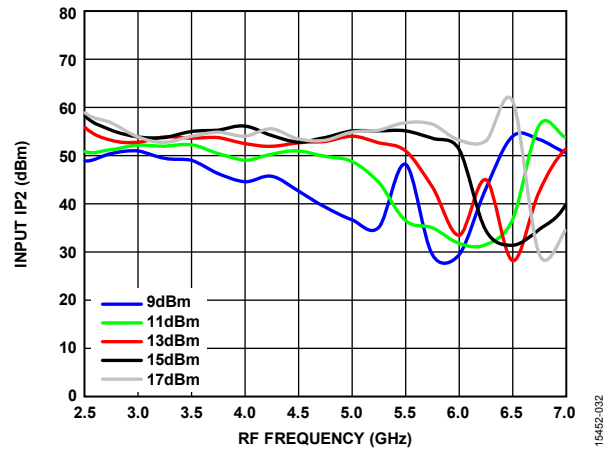

Figure 32. Input IP2 vs. RF Frequency at Various LO Powers

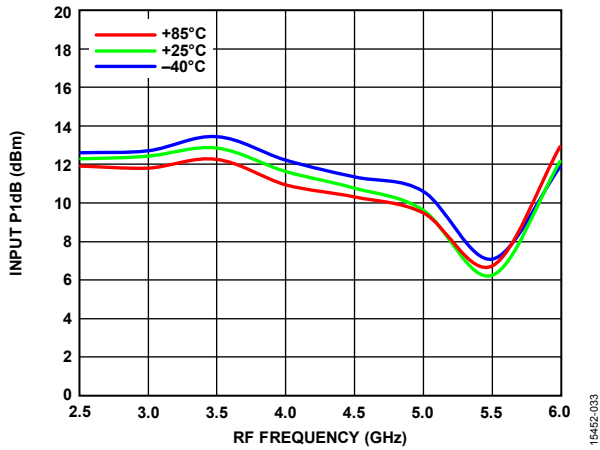

Figure 33. Input P1dB vs. RF Frequency at Various Temperatures

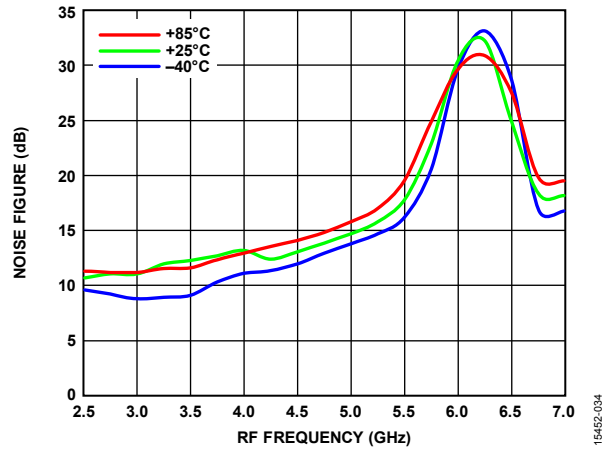

Figure 34. Noise Figure vs. RF Frequency at Various Temperatures

Data taken as downconverter, upper sideband, $T_A = 25^\circ\text{C}$, $IF = 100\text{ MHz}$, and $LO\text{ power} = 13\text{ dBm}$, unless otherwise noted.

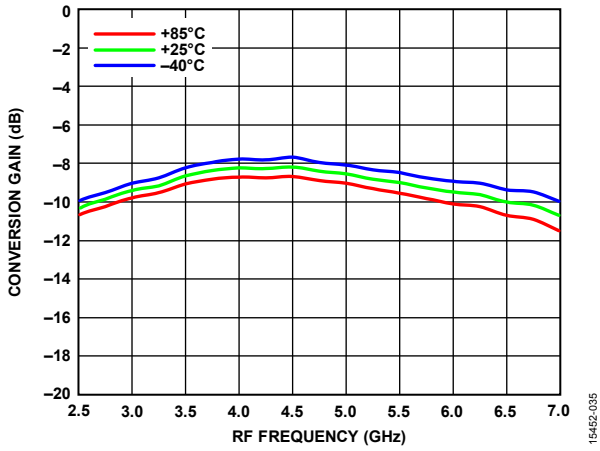

Figure 35. Conversion Gain vs. RF Frequency at Various Temperatures

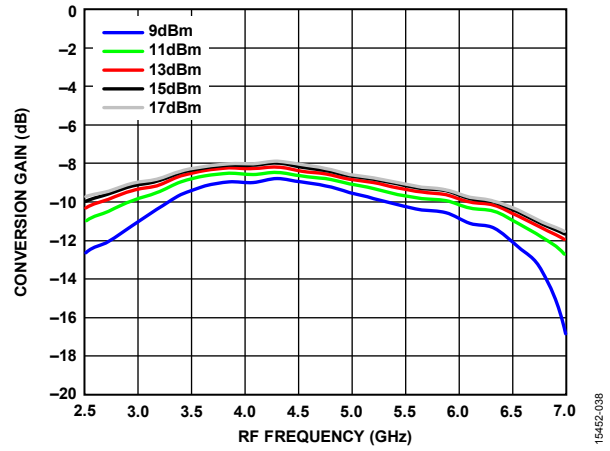

Figure 38. Conversion Gain vs. RF Frequency at Various LO Powers

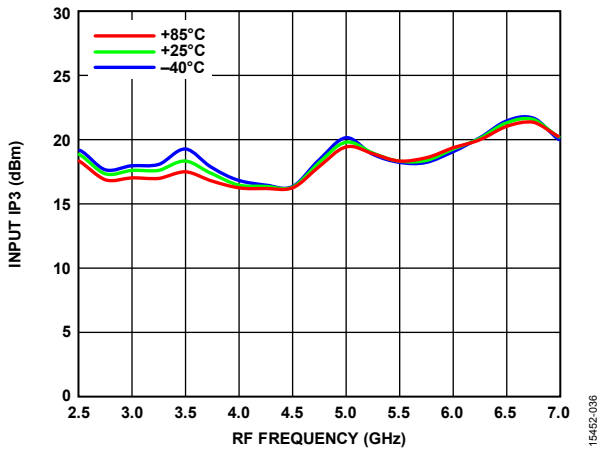

Figure 36. Input IP3 vs. RF Frequency at Various Temperatures

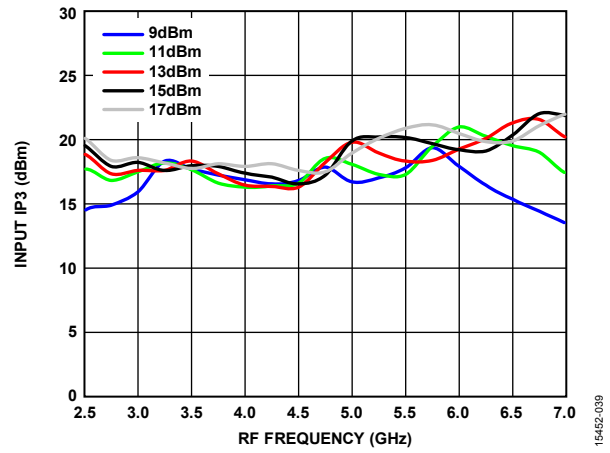

Figure 39. Input IP3 vs. RF Frequency at Various LO Powers

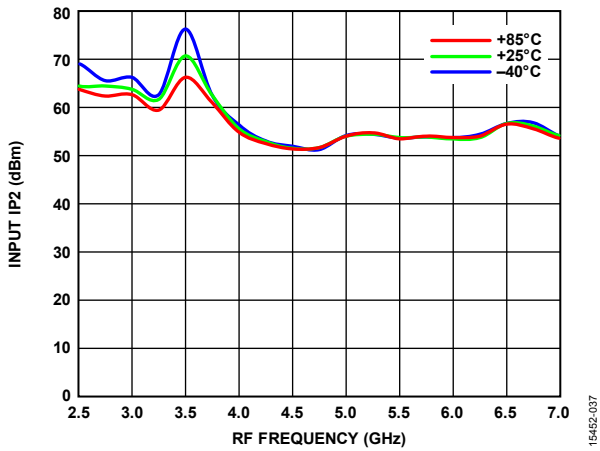

Figure 37. Input IP2 vs. RF Frequency at Various Temperatures

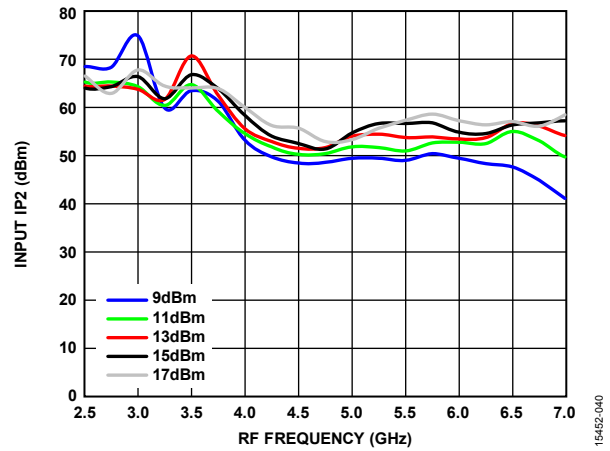

Figure 40. Input IP2 vs. RF Frequency at Various LO Powers

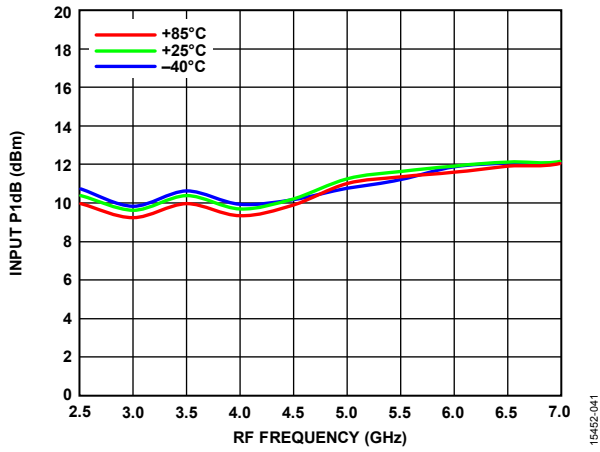

Figure 41. Input P1dB vs. RF Frequency at Various Temperatures

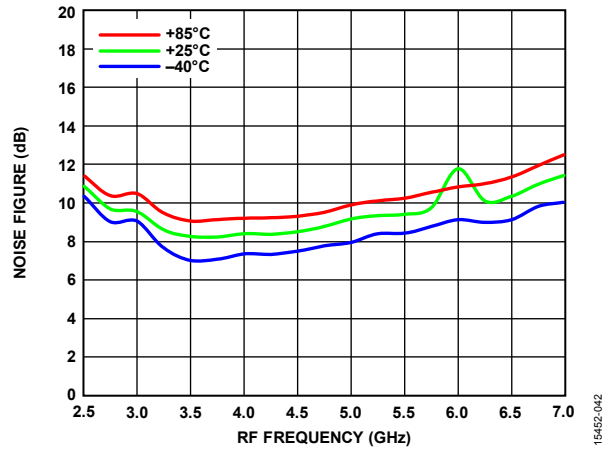

Figure 42. Noise Figure vs. RF Frequency at Various Temperatures

Data taken as downconverter, upper sideband, $T_A = 25^\circ\text{C}$, $IF = 1000\text{ MHz}$, and $LO\text{ power} = 13\text{ dBm}$, unless otherwise noted.

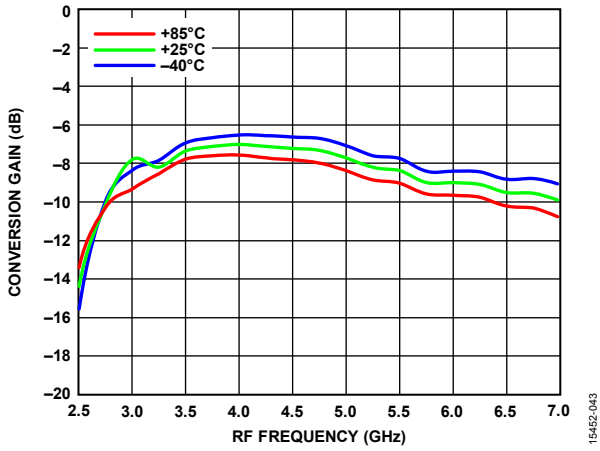

Figure 43. Conversion Gain vs. RF Frequency at Various Temperatures

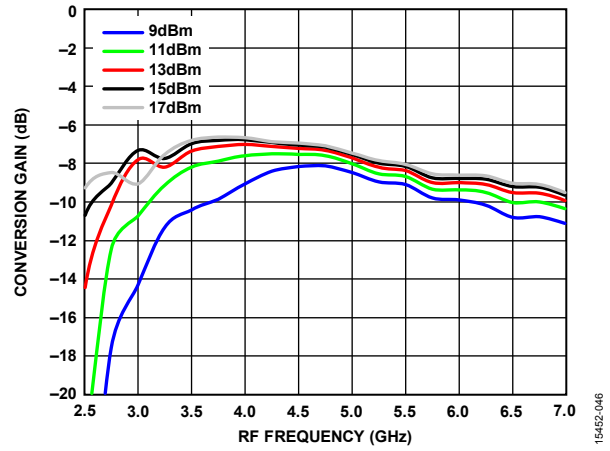

Figure 46. Conversion Gain vs. RF Frequency at Various LO Powers

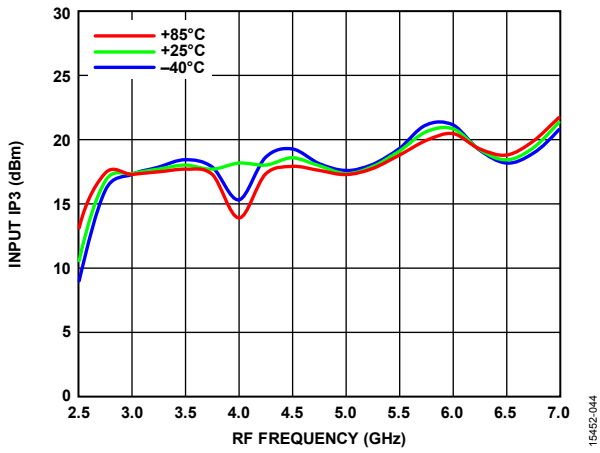

Figure 44. Input IP3 vs. RF Frequency at Various Temperatures

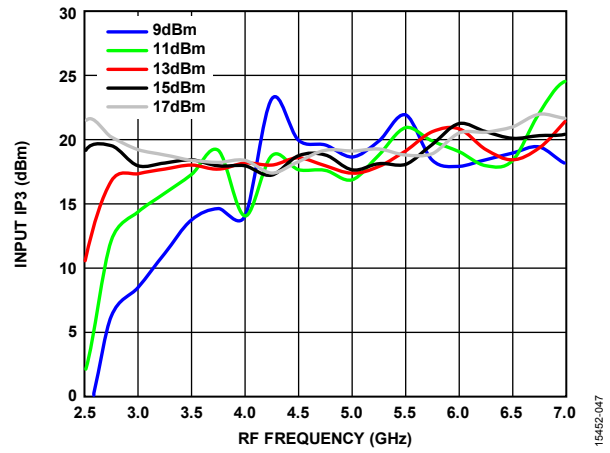

Figure 47. Input IP3 vs. RF Frequency at Various LO Powers

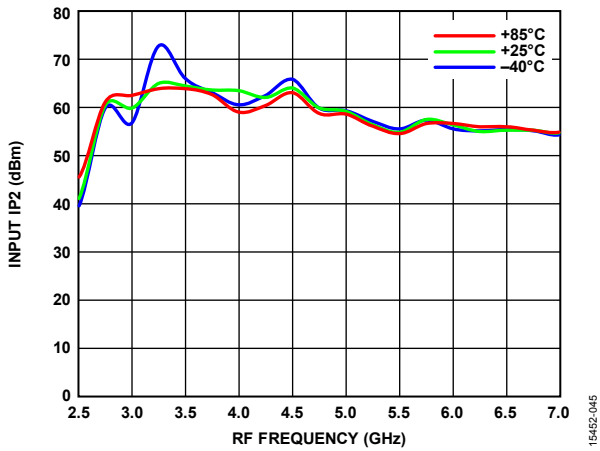

Figure 45. Input IP2 vs. RF Frequency at Various Temperatures

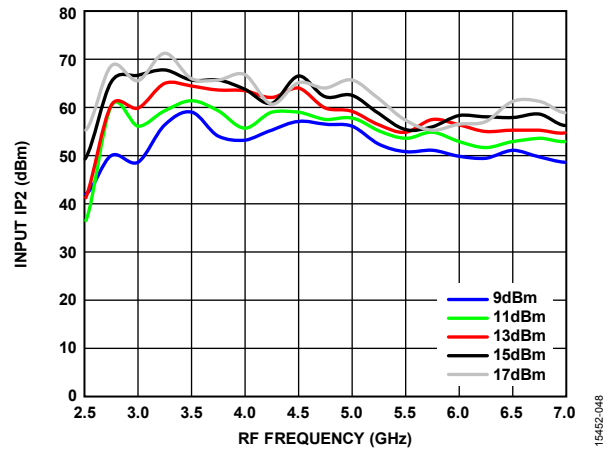

Figure 48. Input IP2 vs. RF Frequency at Various LO Powers

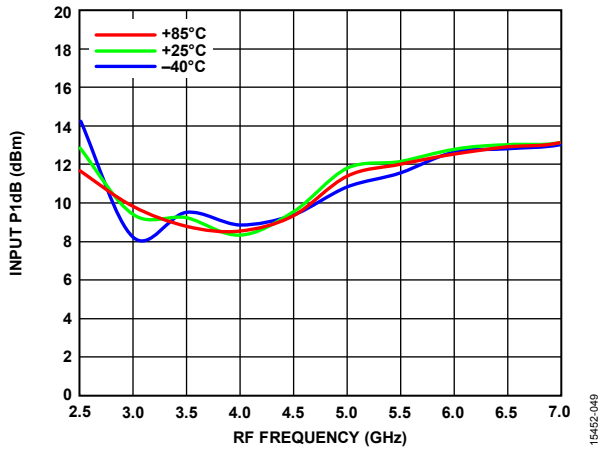

Figure 49. Input P1dB vs. RF Frequency at Various Temperatures

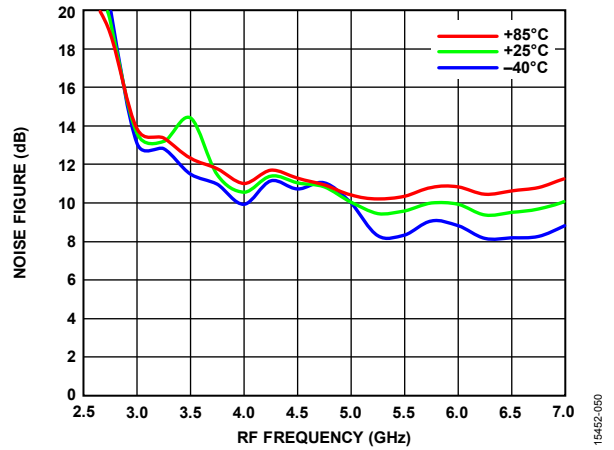

Figure 50. Noise Figure vs. RF Frequency at Various Temperatures

Data taken as downconverter, upper sideband, $T_A = 25^\circ\text{C}$, $IF = 2000\text{ MHz}$, and $LO\text{ power} = 13\text{ dBm}$, unless otherwise noted.

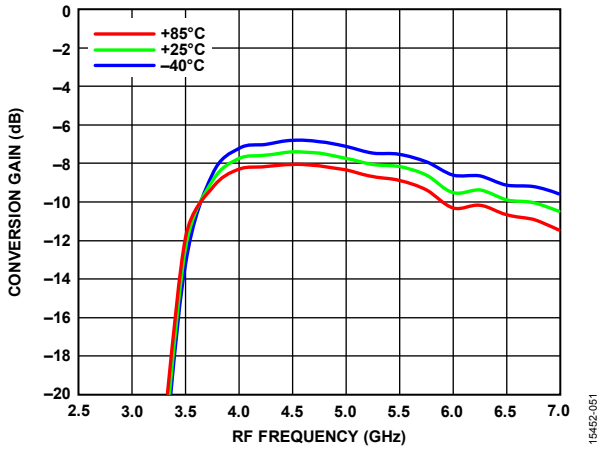

Figure 51. Conversion Gain vs. RF Frequency at Various Temperatures

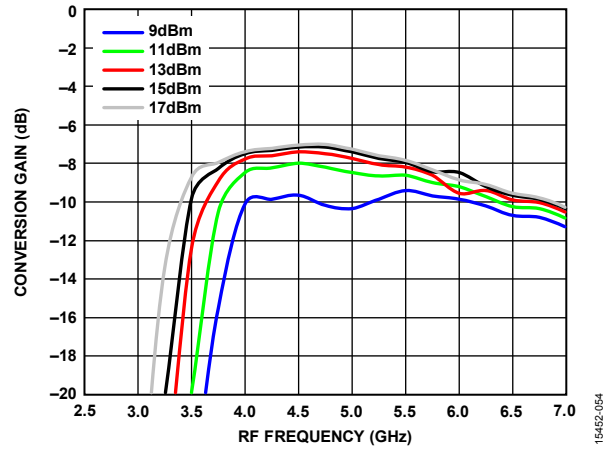

Figure 54. Conversion Gain vs. RF Frequency at Various LO Powers

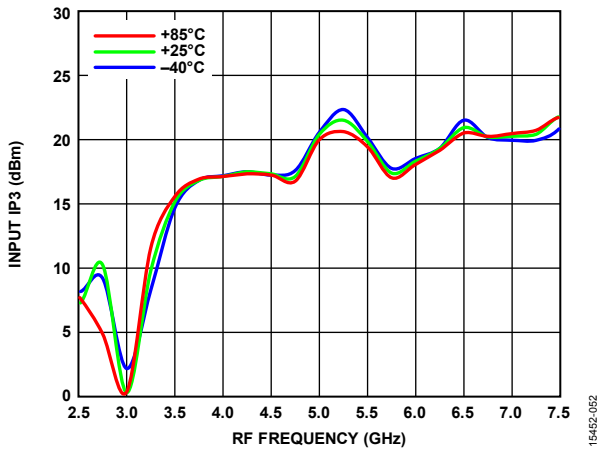

Figure 52. Input IP3 vs. RF Frequency at Various Temperatures

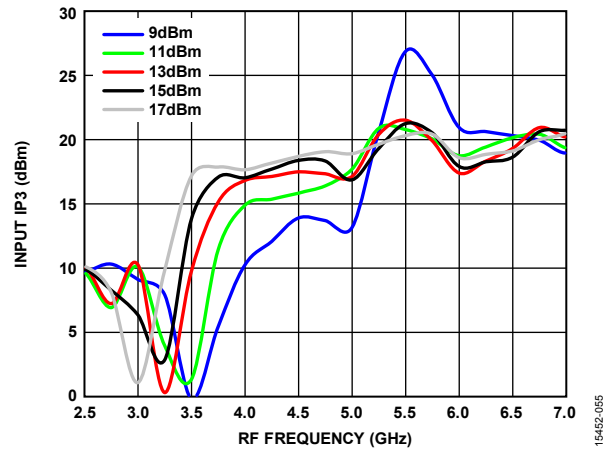

Figure 55. Input IP3 vs. RF Frequency at Various LO Powers

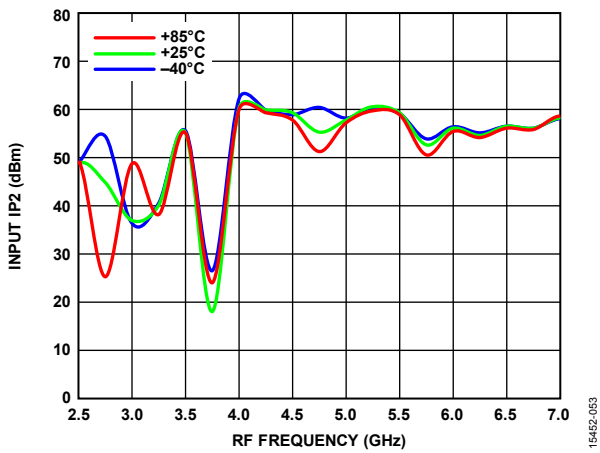

Figure 53. Input IP2 vs. RF Frequency at Various Temperatures

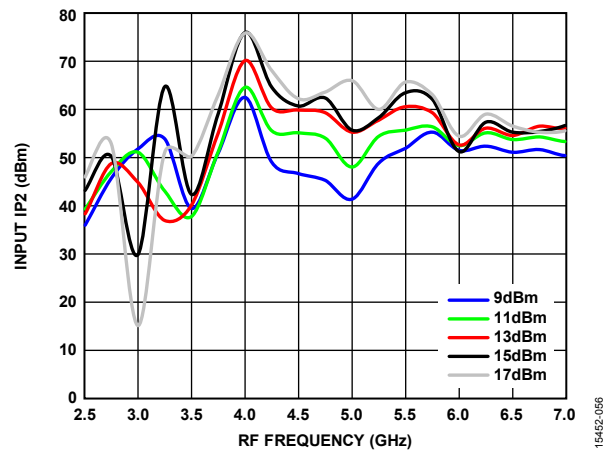

Figure 56. Input IP2 vs. RF Frequency at Various LO Powers

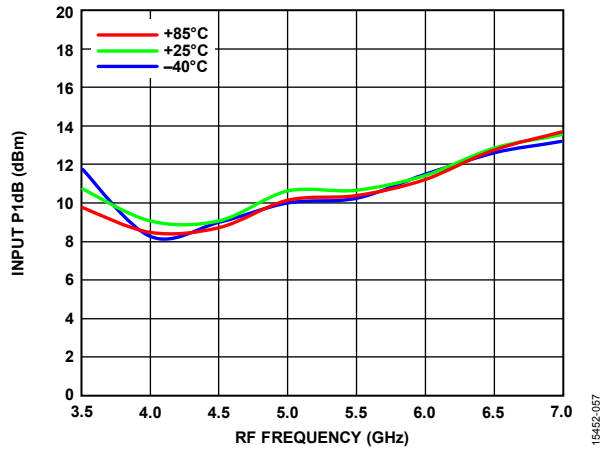

Figure 57. Input P1dB vs. RF Frequency at Various Temperatures

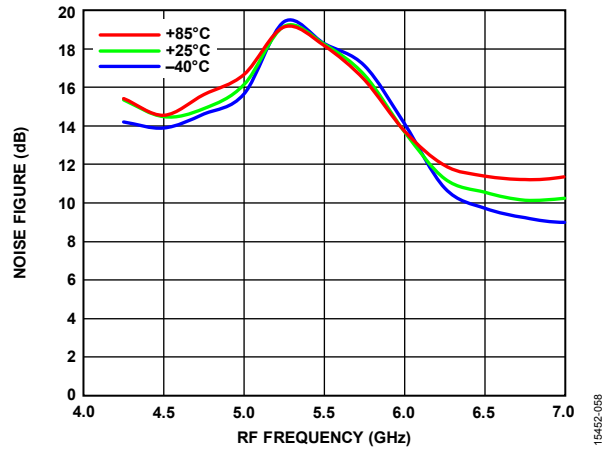

Figure 58. Noise Figure vs. RF Frequency at Various Temperatures

UPCONVERTER PERFORMANCE

Data taken as upconverter, lower sideband, $T_A = 25^\circ\text{C}$, $IF = 100\text{ MHz}$, and $LO\text{ power} = 13\text{ dBm}$, unless otherwise noted.

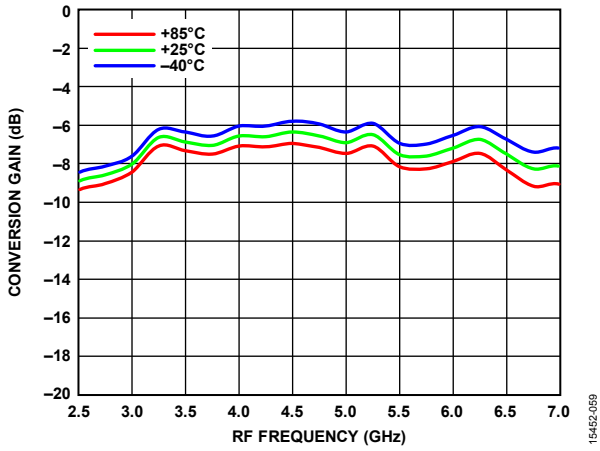

Figure 59. Conversion Gain vs. RF Frequency at Various Temperatures

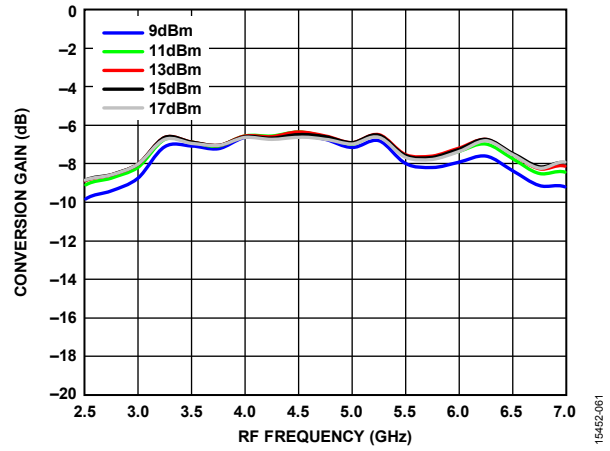

Figure 61. Conversion Gain vs. RF Frequency at Various LO Powers

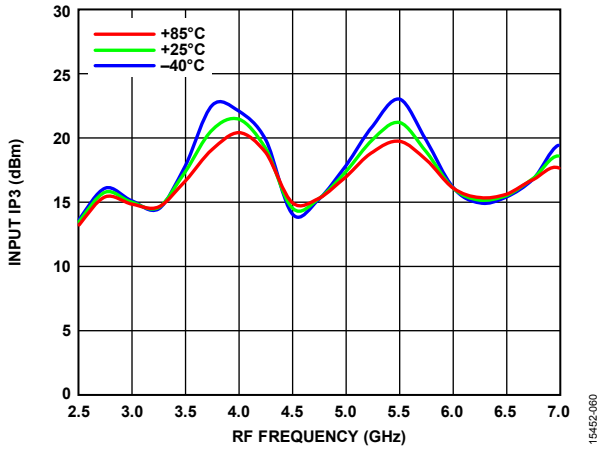

Figure 60. Input IP3 vs. RF Frequency at Various Temperatures

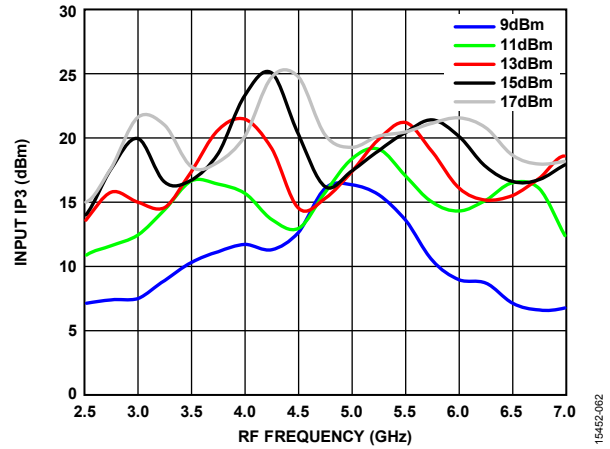

Figure 62. Input IP3 vs. RF Frequency at Various LO Powers

Data taken as upconverter, lower sideband, $T_A = 25^\circ\text{C}$, $\text{IF} = 1000\text{ MHz}$, and $\text{LO drive level} = 13\text{ dBm}$, unless otherwise noted.

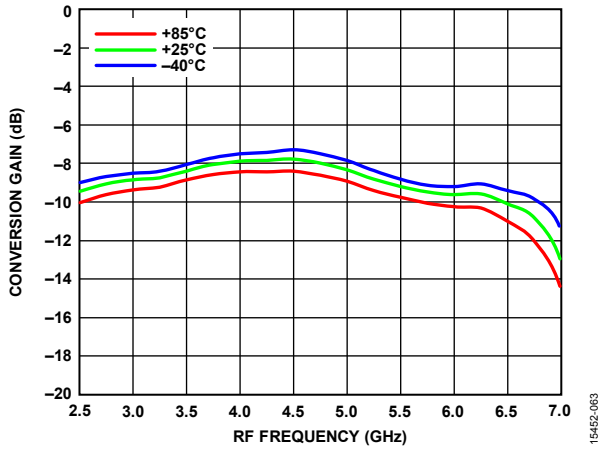

Figure 63. Conversion Gain vs. RF Frequency at Various Temperatures

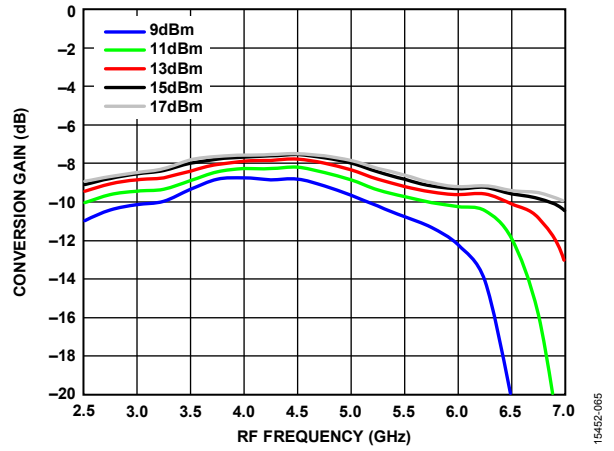

Figure 65. Conversion Gain vs. RF Frequency at Various LO Powers

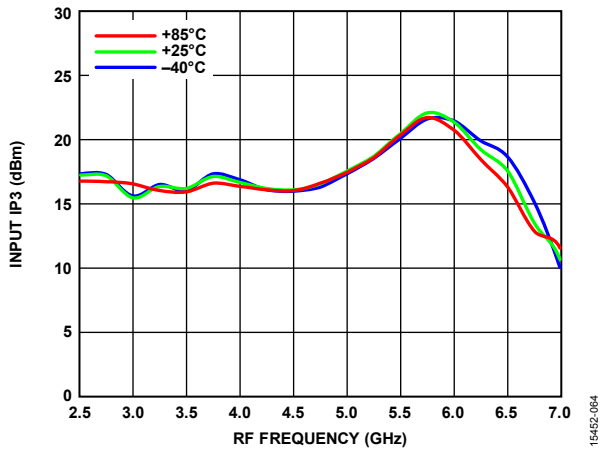

Figure 64. Input IP3 vs. RF Frequency at Various Temperatures

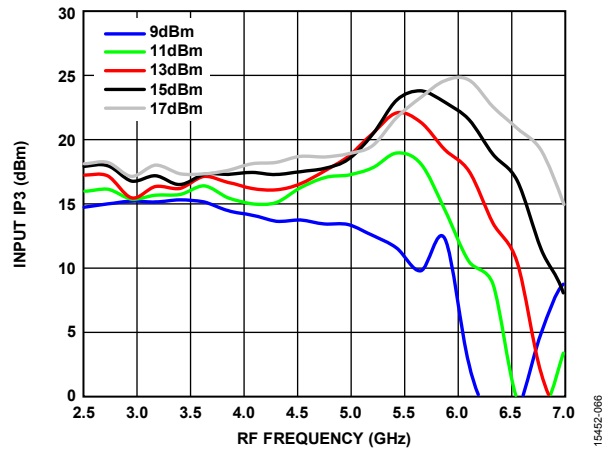

Figure 66. Input IP3 vs. RF Frequency at Various LO Powers

Data taken as upconverter, lower sideband, $T_A = 25^\circ\text{C}$, $IF = 2000\text{ MHz}$, and LO drive level = 13 dBm, unless otherwise noted.

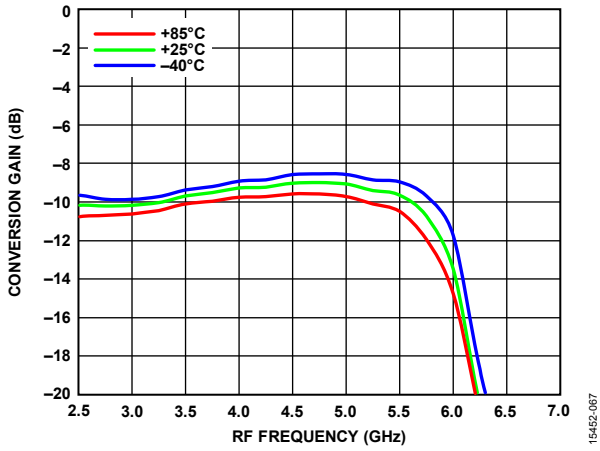

Figure 67. Conversion Gain vs. RF Frequency at Various Temperatures

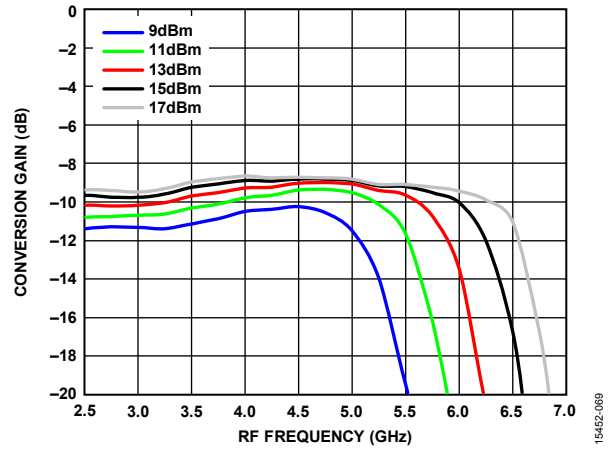

Figure 69. Conversion Gain vs. RF Frequency at Various LO Powers

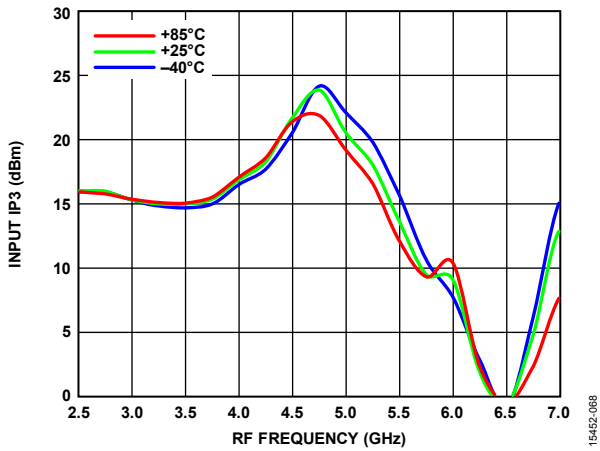

Figure 68. Input IP3 vs. RF Frequency at Various Temperatures

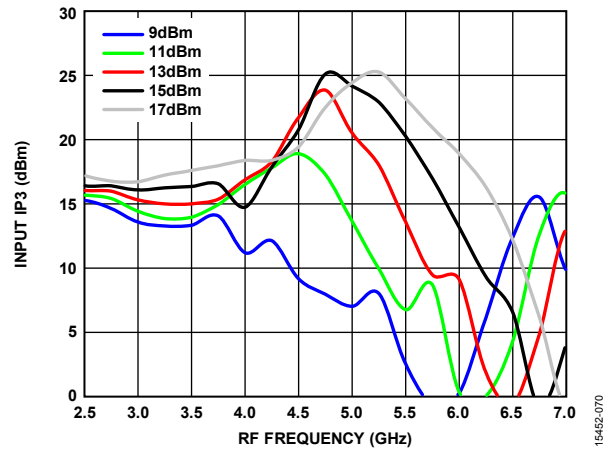

Figure 70. Input IP3 vs. RF Frequency at Various LO Powers

Data taken as upconverter, upper sideband, $T_A = 25^\circ\text{C}$, $IF = 100\text{ MHz}$, and LO drive level = 13 dBm, unless otherwise noted.

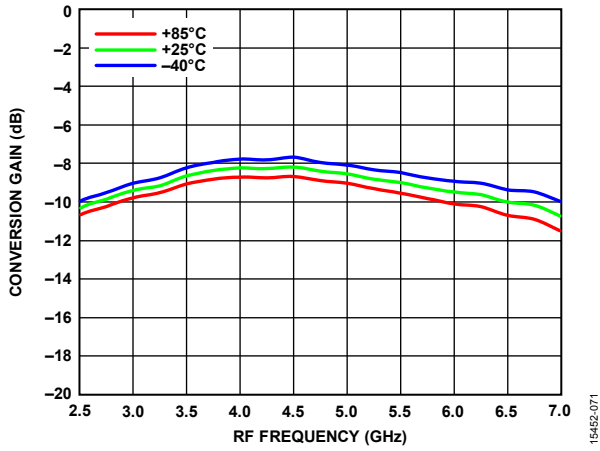

Figure 71. Conversion Gain vs. RF Frequency at Various Temperatures

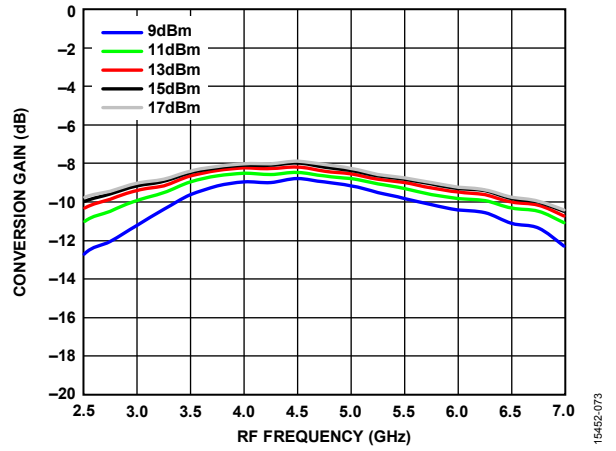

Figure 73. Conversion Gain vs. RF Frequency at Various LO Powers

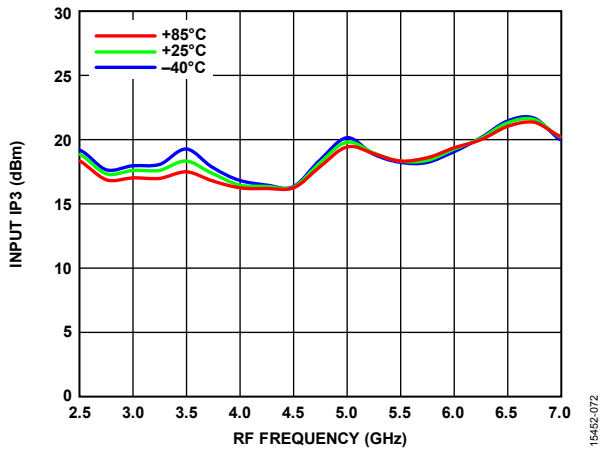

Figure 72. Input IP3 vs. RF Frequency at Various Temperatures

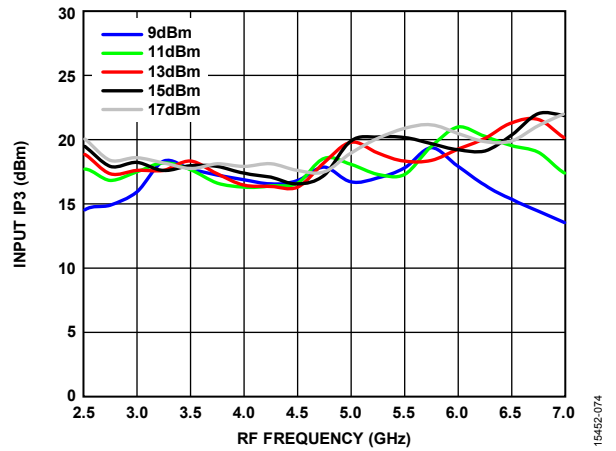

Figure 74. Input IP3 vs. RF Frequency at Various LO Powers

Data taken as upconverter, upper sideband, $T_A = 25^\circ\text{C}$, $IF = 1000\text{ MHz}$, and LO drive level = 13 dBm, unless otherwise noted.

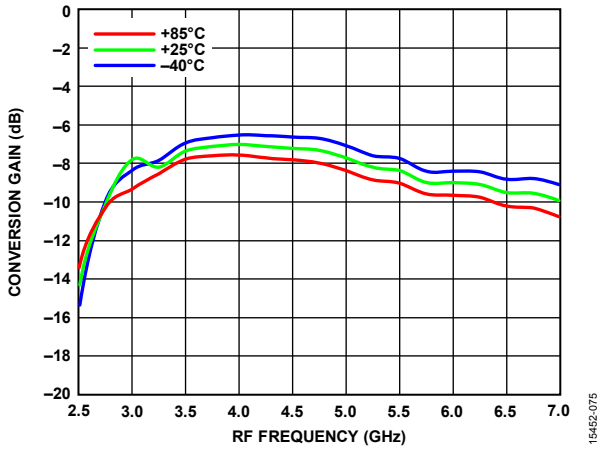

Figure 75. Conversion Gain vs. RF Frequency at Various Temperatures

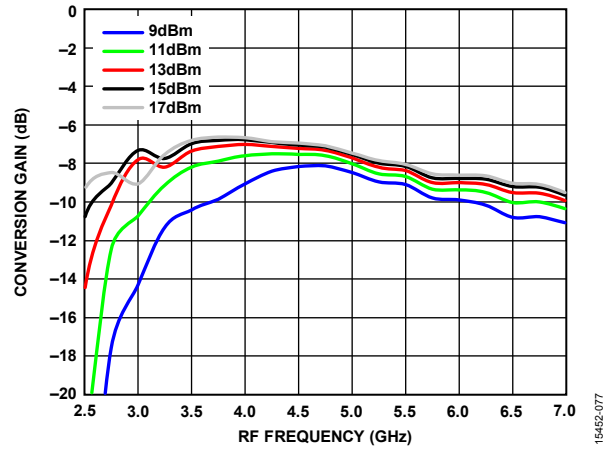

Figure 77. Conversion Gain vs. RF Frequency at Various LO Powers

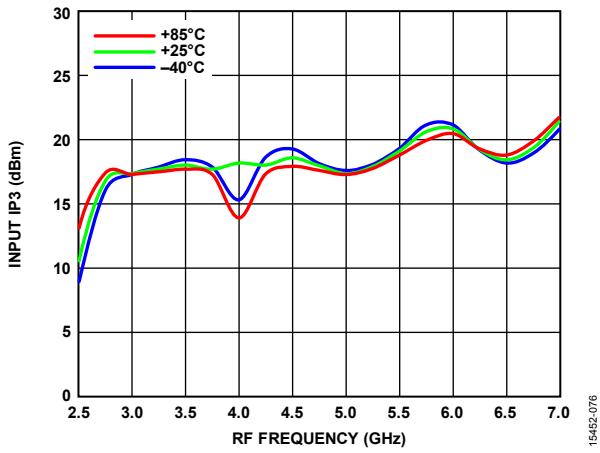

Figure 76. Input IP3 vs. RF Frequency at Various Temperatures

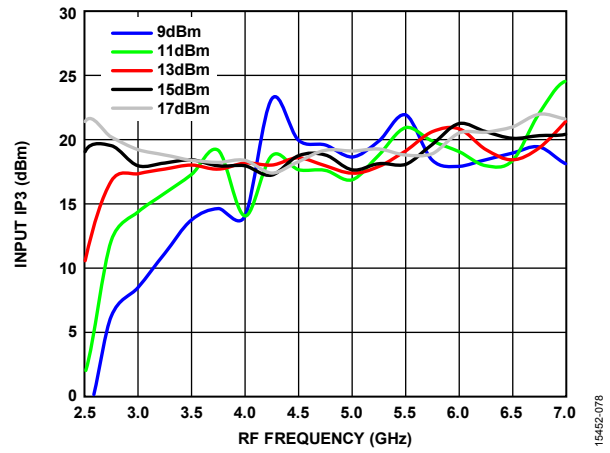

Figure 78. Input IP3 vs. RF Frequency at Various LO Powers

Data taken as upconverter, upper sideband, $T_A = 25^\circ\text{C}$, $IF = 2000\text{ MHz}$, and LO drive level = 13 dBm, unless otherwise noted.

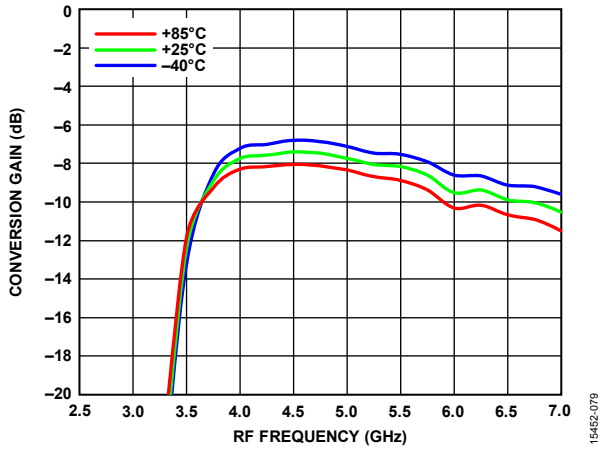

Figure 79. Conversion Gain vs. RF Frequency at Various Temperatures

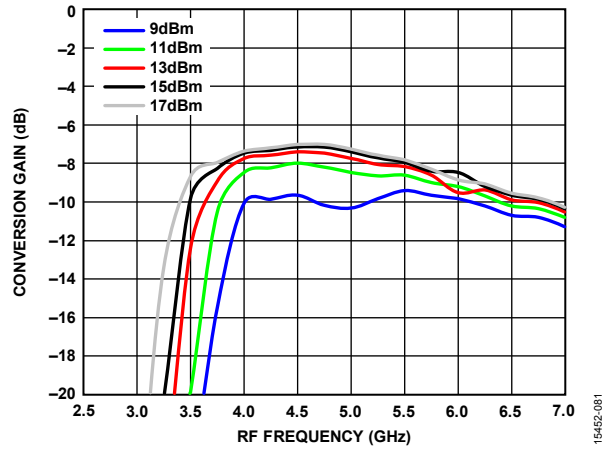

Figure 81. Conversion Gain vs. RF Frequency at Various LO Powers

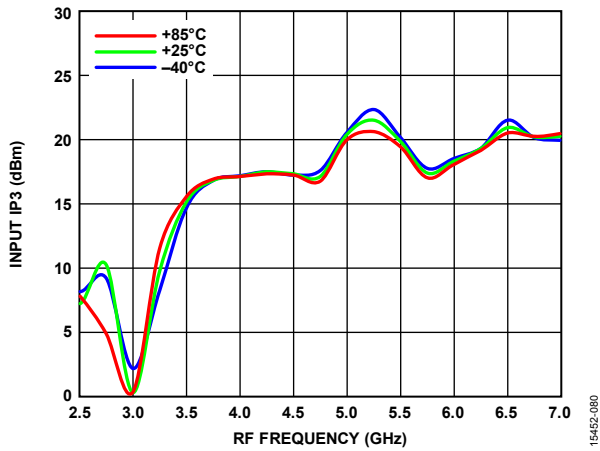

Figure 80. Input IP3 vs. RF Frequency at Various Temperatures

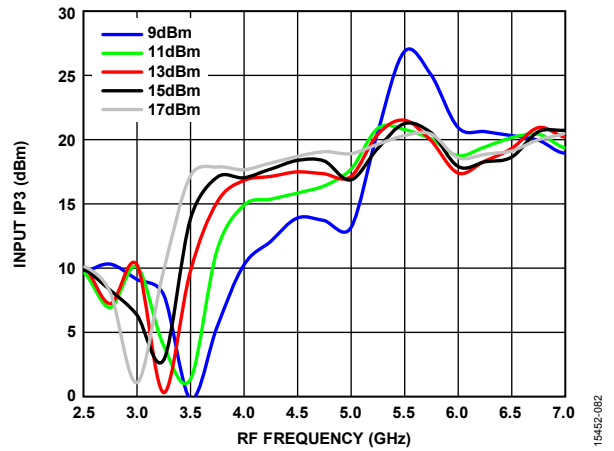

Figure 82. Input IP3 vs. RF Frequency at Various LO Powers

SPURIOUS AND HARMONICS PERFORMANCE

Mixer spurious products are measured in dBc from the IF output power level, unless otherwise noted. Spur values are (M × RF) – (N × LO).

M × N Spurious Outputs, IF = 100 MHz

RF = +2.5 GHz, LO = +2.6 GHz, RF power = –10 dBm, and LO power = +13 dBm.

		N × LO					
		0	1	2	3	4	5
M × RF	0		1	28	27	55	39
	1	7	N/A ¹	20	35	44	62
	2	79	62	73	86	82	77
	3	81	72	67	67	73	81
	4	83	82	85	85	90	85
	5	83	82	81	84	87	90

¹ N/A means not applicable.

RF = +4.5 GHz, LO = +4.6 GHz, RF power = –10 dBm, and LO power = +13 dBm.

		N × LO					
		0	1	2	3	4	5
M × RF	0		3	39	31	35	33
	1	15	N/A ¹	34	46	71	57
	2	85	55	57	57	83	76
	3	80	83	74	71	88	86
	4	80	81	84	87	88	89
	5	80	79	80	84	86	89

¹ N/A means not applicable.

RF = +6 GHz, LO = +6.1 GHz, RF power = –10 dBm, and LO power = +13 dBm.

		N × LO ¹					
		0	1	2	3	4	5
M × RF	0		7	39	28	29	N/A
	1	17	N/A	38	51	45	42
	2	79	72	62	85	83	79
	3	81	84	82	78	87	82
	4	76	79	83	87	89	85
	5	N/A	76	79	84	86	89

¹ N/A means not applicable.

M × N Spurious Outputs, IF = 1000 MHz

RF = +2.5 GHz, LO = +3.5 GHz, RF power = –10 dBm, and LO power = +13 dBm.

		N × LO					
		0	1	2	3	4	5
M × RF	0		–2	+22	+17	+51	+36
	1	+7	N/A ¹	+29	+38	+56	+61
	2	+75	+55	+62	+76	+80	+75
	3	+77	+61	+69	+60	+82	+81
	4	+82	+83	+60	+69	+62	+78
	5	+80	+83	+74	+63	+55	+79

¹ N/A means not applicable.

RF = +4.5 GHz, LO = +5.5 GHz, RF power = –10 dBm, and LO power = +13 dBm.

		N × LO ¹					
		0	1	2	3	4	5
M × RF	0		6	44	27	29	N/A
	1	13	N/A	36	51	45	45
	2	85	57	64	74	82	79
	3	81	83	76	71	84	82
	4	81	83	84	89	86	84
	5	77	79	85	87	90	87

¹ N/A means not applicable.

RF = +6 GHz, LO = +7 GHz, RF power = –10 dBm, and LO power = +13 dBm.

		N × LO ¹					
		0	1	2	3	4	5
M × RF	0		6	36	22	N/A	N/A
	1	16	N/A	37	60	29	N/A
	2	80	68	59	70	78	64
	3	79	82	73	66	82	78
	4	70	79	83	65	73	80
	5	N/A	67	79	70	59	67

¹ N/A means not applicable.

THEORY OF OPERATION

The [HMC219B](#) is a general-purpose, double balanced mixer in an 8-lead, MINI_SO_EP, RoHS-compliant package that can be used as an upconverter or a downconverter from 2.5 GHz to 7.0 GHz.

When used as a downconverter, the [HMC219B](#) downconverts RF between 2.5 GHz and 7.0 GHz to IF between dc and 3 GHz.

When used as an upconverter, the mixer upconverts IF between dc and 3 GHz to RF between 2.5 GHz and 7.0 GHz.

The mixer provides excellent LO to RF and LO to IF isolation due to optimized balun structures. The [HMC219B](#) requires no external components or matching circuitry. The RoHS compliant [HMC219B](#) eliminates the need for wire bonding and is compatible with high volume, surface-mount manufacturing techniques.

APPLICATIONS INFORMATION

TYPICAL APPLICATION CIRCUIT

Figure 83 shows the typical application circuit for the [HMC219B](#). The [HMC219B](#) is a passive device and does not require any external components. The LO and RF pins are internally dc-coupled. When IF operation is not required until dc, use an ac-coupled capacitor at the IF port. When IF operation to dc is required, do not exceed the IF source and sink the current rating specified in the Absolute Maximum Ratings section.

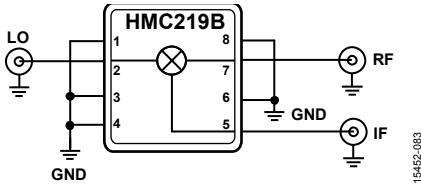

Figure 83. Typical Application Circuit

EVALUATION PCB INFORMATION

RF circuit design techniques must be implemented for the evaluation board PCB shown in Figure 84. Signal lines must have 50 Ω impedance, and the package ground leads and exposed pad must connect directly to the ground plane, similar to what is shown in Figure 84. Use a sufficient number of via holes to connect the top and bottom ground planes. The evaluation circuit board shown in Figure 84 is available from Analog Devices, Inc., upon request. Reference [EV1HMC219BMS8G](#) when ordering the evaluation PCB assembly. The bill of materials for the evaluation PCB is shown in Table 5.

Table 5. Bill of Materials for Evaluation PCB
[EV1HMC219BMS8G](#)

Reference Designator	Description
J1 to J3	SMA RF connectors
U1	HMC219B
PCB ¹	101650 evaluation PCB, Rogers 4350

¹ 101650 is the bare [EV1HMC219BMS8G](#) PCB.

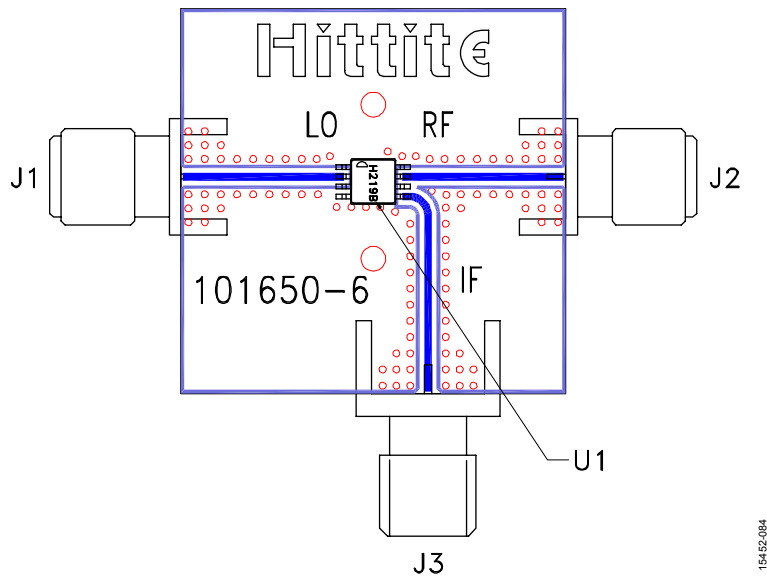
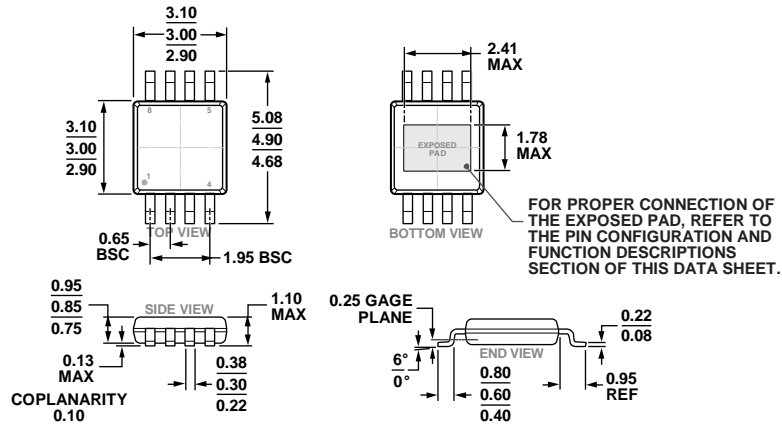

Figure 84. [HMC219B](#) Evaluation PCB

OUTLINE DIMENSIONS



COMPLIANT TO JEDEC STANDARDS MO-187-AA-T
 Figure 85. 8-Lead Mini Small Outline Package with Exposed Pad (MINI_SO_EP)
 (RH-8-4)
 Dimensions shown in millimeters)

ORDERING GUIDE

Model ^{1,2}	Temperature Range	MSL Rating ³	Package Body Material	Package Description	Package Option	Package Marking ⁴
HMC219BMS8GE	-40°C to +85°C	MSL1	Low Stress Injection Molded Plastic	8-Lead MINI_SO_EP	RH-8-4	H219B XXXX
HMC219BMS8GETR	-40°C to +85°C	MSL1	Low Stress Injection Molded Plastic	8-Lead MINI_SO_EP	RH-8-4	H219B XXXX
EV1HMC219BMS8G				Evaluation PCB Assembly		

¹ The HMC219BMS8GE and the HMC219BMS8GETR are RoHS Compliant Parts.
² Lead finish, 100% SN 10 micron minimum.
³ See the Absolute Maximum Ratings section.
⁴ XXXX = four digit lot number.

Компания «Life Electronics» занимается поставками электронных компонентов импортного и отечественного производства от производителей и со складов крупных дистрибьюторов Европы, Америки и Азии.

С конца 2013 года компания активно расширяет линейку поставок компонентов по направлению коаксиальный кабель, кварцевые генераторы и конденсаторы (керамические, пленочные, электролитические), за счёт заключения дистрибьюторских договоров

Мы предлагаем:

- Конкурентоспособные цены и скидки постоянным клиентам.
- Специальные условия для постоянных клиентов.
- Подбор аналогов.
- Поставку компонентов в любых объемах, удовлетворяющих вашим потребностям.
- Приемлемые сроки поставки, возможна ускоренная поставка.
- Доставку товара в любую точку России и стран СНГ.
- Комплексную поставку.
- Работу по проектам и поставку образцов.
- Формирование склада под заказчика.
- Сертификаты соответствия на поставляемую продукцию (по желанию клиента).
- Тестирование поставляемой продукции.
- Поставку компонентов, требующих военную и космическую приемку.
- Входной контроль качества.
- Наличие сертификата ISO.

В составе нашей компании организован Конструкторский отдел, призванный помогать разработчикам, и инженерам.

Конструкторский отдел помогает осуществить:

- Регистрацию проекта у производителя компонентов.
- Техническую поддержку проекта.
- Защиту от снятия компонента с производства.
- Оценку стоимости проекта по компонентам.
- Изготовление тестовой платы монтаж и пусконаладочные работы.



Тел: +7 (812) 336 43 04 (многоканальный)

Email: org@lifeelectronics.ru