

J-Series SiPM Sensors

Silicon Photomultipliers (SiPM), High PDE and Timing Resolution Sensors in a TSV Package



ON Semiconductor®

www.onsemi.com

ON Semiconductor's J-Series low-light sensors feature a high PDE (photon detection efficiency) that is achieved using a high-volume, P-on-N silicon foundry process. The J-Series sensors incorporate major improvements in the transit time spread which results in a significant improvement in the timing performance of the sensor. J-Series sensors are available in different sizes (3 mm, 4 mm and 6 mm) and use a TSV (Through Silicon Via) process to create a package with minimal deadspace, that is compatible with industry standard lead-free, reflow soldering processes.

The J-Series Silicon Photomultipliers (SiPM) combine high performance with the practical advantages of solid-state technology: low operating voltage, excellent temperature stability, robustness, compactness, output uniformity, and low cost. For more information on the J-Series sensors please refer to the [website](#).



ORDERING INFORMATION

See detailed ordering and shipping information on page 11 of this data sheet.

Table 1. GENERAL PARAMETERS

| Parameter (Note 1) | Minimum | Typical | Maximum | Unit |
|-------------------------------------|---------|---------|---------|-------|
| Breakdown Voltage (Vbr) (Note 2) | 24.2 | | 24.7 | V |
| Overvoltage (OV) | 1 | | 6 | V |
| Operating Voltage (Vop = Vbr + OV) | 25.2 | | 30.7 | V |
| Spectral Range (Note 3) | 200 | | 900 | nm |
| Peak PDE Wavelength (λ_p) | | 420 | | nm |
| Temperature dependence of Vbr | | 21.5 | | mV/°C |

1. All measurements made at 21°C unless otherwise stated.
2. The breakdown voltage (Vbr) is defined as the value of the voltage intercept of a straight line fit to a plot of \sqrt{I} vs V, where I is the current and V is the bias voltage.
3. The range where PDE > 2.0% at Vbr + 6.0 V.

Table 2. PHYSICAL PARAMETERS

| Parameter | 3 mm | 4 mm | 6 mm |
|-----------------------|-------------------------------|-----------------------------|-----------------------------|
| | 30020, 30035 | 40035 | 60035 |
| Active Area | 3.07 × 3.07 mm ² | 3.93 × 3.93 mm ² | 6.07 × 6.07 mm ² |
| No. of Microcells | 30020: 14,410 30035: 5,676 | 40035: 9,260 | 60035: 22,292 |
| Microcell Fill Factor | 30020: 62% 30035: 75% | 40035: 75% | 60035: 75% |

J-Series SiPM Sensors

Table 3. PERFORMANCE PARAMETERS

| Parameter (Note 4) | 30035 | | 40035 | | 60035 | | Unit |
|---|-------------------|-------------------|-------------------|-------------------|-------------------|-------------------|---------------------|
| | Overvoltage | | | | | | Unit |
| | +2.5 V | +6 V | +2.5 V | +6 V | +2.5 V | +6 V | |
| PDE (Note 5) | 38 | 50 | 38 | 50 | 38 | 50 | % |
| Dark Count Rate | 50 | 150 | 50 | 150 | 50 | 150 | kHz/mm ² |
| Gain (anode-cathode) | 2.9×10^6 | 6.3×10^6 | 2.9×10^6 | 6.3×10^6 | 2.9×10^6 | 6.3×10^6 | |
| Dark Current – typical | 0.23 | 1.9 | 0.35 | 3.0 | 0.9 | 7.5 | μA |
| Dark Current – maximum | 0.31 | 3.00 | 0.45 | 4.0 | 1.25 | 12.0 | |
| Rise Time (Note 6) – anode-cathode output | 90 | 110 | 90 | 110 | 180 | 250 | ps |
| Microcell Recharge Time Constant (Note 7) | 45 | | 48 | | 50 | | ns |
| Capacitance (Note 8) (anode output) | 1070 | | 1800 | | 4140 | | pF |
| Capacitance (Note 8) (fast output) | 40 | | 70 | | 160 | | pF |
| Fast Output Pulse Width (FWHM) | 1.5 | | 1.7 | | 3.0 | | ns |
| Crosstalk | 8 | 25 | 8 | 25 | 8 | 25 | % |
| Afterpulsing | 0.75 | 5.0 | 0.75 | 5.0 | 0.75 | 5.0 | % |
| Parameter (Note 4) | 30020 | | | | | | Unit |
| | Overvoltage | | | | | | |
| | +2.5 V | | | +5 V | | | |
| PDE (Note 5) | 30 | | | 38 | | | % |
| Dark Count Rate | 50 | | | 125 | | | kHz/mm ² |
| Gain (anode-cathode) | 1.0×10^6 | | | 1.9×10^6 | | | |
| Dark Current – typical | 0.1 | | | 0.45 | | | μA |
| Dark Current – maximum | 0.2 | | | 0.72 | | | |
| Rise Time (Note 6) – anode-cathode output | 130 | | | 160 | | | ps |
| Microcell Recharge Time Constant (Note 7) | 15 | | | | | | ns |
| Capacitance (Note 8) (anode output) | 1040 | | | | | | pF |
| Capacitance (Note 8) (fast output) | 50 | | | | | | pF |
| Fast Output Pulse Width (FWHM) | 1.4 | | | | | | ns |
| Crosstalk | 2.5 | | | 7.5 | | | % |
| Afterpulsing | 0.75 | | | 5.0 | | | % |

4. All measurements made at 21°C unless otherwise stated.

5. PDE does not contain afterpulsing or crosstalk, and is quoted at the peak wavelength (λ_p).

6. Measured as time to go from 10% to 90% of the peak amplitude and measured over a 1 Ω series output resistor.

7. RC charging time constant of the microcell (τ).

8. Capacitance values are for the complete TSV package.

Table 4. TVS PACKAGE SPECIFICS

| | 3 mm | | 4 mm | | 6 mm | |
|---|-----------------------------|-------|-----------------------------|--|-----------------------------|--|
| | 30020, 30035 | | 40035 | | 60035 | |
| Package Dimensions | 3.16 × 3.16 mm ² | | 4.00 × 4.00 mm ² | | 6.13 × 6.13 mm ² | |
| Recommended Operating Temperature Range | –40°C – +85°C | | | | | |
| Soldering Conditions | Reflow Solder | | | | | |
| Cover Material | Glass | | | | | |
| Cover Refractive Index | 1.53 @ 436 nm | | | | | |
| Moisture Sensitivity Level | Tape & reel | MSL3* | | | | |
| | Cut tape | MSL4* | | | | |
| Maximum Average Current | 10 mA | | 10 mA | | 15 mA | |

*Please refer to the [TSV Handling and Soldering](#) guide for more information on MSL for different delivery options.

J-Series SiPM Sensors

PERFORMANCE PLOTS



Figure 1. Photon Detection Efficiency (PDE)
(MicroFJ-60035-TSV)



Figure 2. PDE vs. Overvoltage
(MicroFJ-60035-TSV)



Figure 3. PDE vs. Crosstalk
(MicroFJ-60035-TSV)

J-Series SiPM Sensors



Figure 4. Gain vs. Overvoltage
(MicroFJ-30035-TSV)

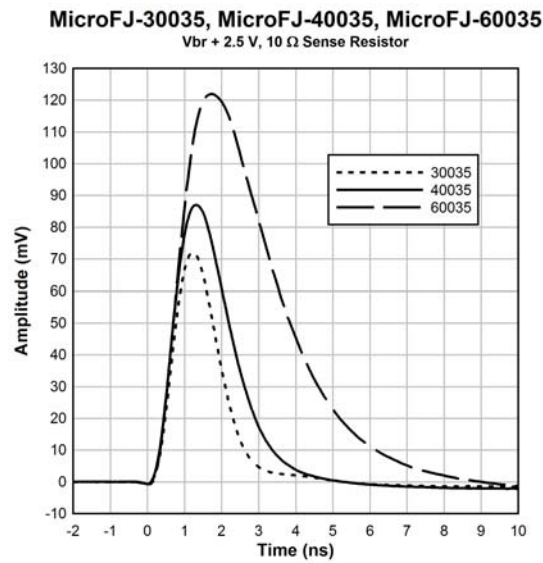

Figure 5. Fast Output Pulse Shape
(MicroFJ-30035, MicroFJ-40035, MicroFJ-60035
Vbr + 2.5 V, 10 Ω Sense Resistor)

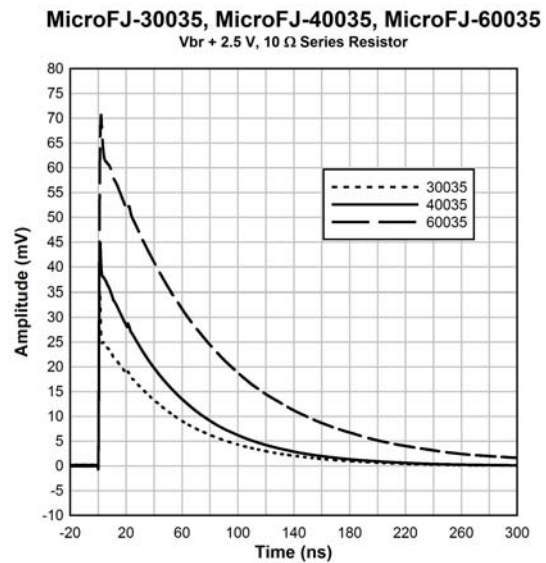

Figure 6. Standard Output Pulse Shape
(MicroFJ-30035, MicroFJ-40035, MicroFJ-60035
Vbr + 2.5 V, 10 Ω Sense Resistor)

J-Series SiPM Sensors

EVALUATION BOARD OPTIONS

SMA BIASING BOARD (MicroFJ-SMA-XXXXX)

The MicroFJ-SMA is a printed circuit board (PCB) that can facilitate the evaluation of the J-Series sensors. The board has three female SMA connectors for connecting the bias voltage, the standard output from the anode and the fast output signal. The output signals can be connected directly to a 50 Ω-terminated oscilloscope for viewing. The biasing and output signal tracks are laid out in such a way as to preserve the fast timing characteristics of the sensor.

The MicroFJ-SMA is recommended for users who require a plug-and-play set-up to quickly evaluate J-Series TSV sensors with optimum timing performance. The board also allows the standard output from the anode to be observed at the same time as the fast output. The outputs can be connected directly to the oscilloscope or measurement device, but external preamplification may be required to boost the signal. The table below lists the SMA board connections. The SMA board electrical schematics are available to download in the [AND9808/D](#) document.



| MicroFJ-SMA-XXXXX | |
|-------------------|-------------------------------|
| Output | Function |
| Vbias | Positive bias input (cathode) |
| Fout | Fast output |
| Sout | Standard output (anode) |

PIN ADAPTER (MicroFJ-SMTPA-XXXXX)

The TSV Pin Adapter board (SMTPA) is a small PCB board that houses the TSV sensor and has through-hole pins to allow its use with standard sockets or probe clips. This product is useful for those needing a quick way to evaluate the TSV package without the need for specialist surface-mount soldering. While this is a ‘quick fix’ suitable for many evaluations, it should be noted that the timing performance from this board will not be optimized and if the best possible timing performance is required, the MicroFJ-SMA-XXXXX is recommended. The SMTPA

circuit schematic is shown in Figure 8. Please consult the [Readout and Biasing Application Note](#) for further information on biasing. The SMTPA board electrical schematics are available to download in the [AND9808/D](#).



Figure 7. Top View of the SMTPA Board Showing the Pin Numbering



Figure 8. SMTPA Circuit Schematic

| MicroFJ-SMTPA-XXXXX | |
|---------------------|-------------|
| Pin No. | Connection |
| 1 | Anode |
| 2 | Fast output |
| 3 | Cathode |
| 4 | Ground |
| 5 | No connect |

J-Series SiPM Sensors

CIRCUIT SCHEMATICS

An SiPM is formed of a large number (hundreds or thousands) of microcells. Each microcell (Figure 9) is an avalanche photodiode with its own quench resistor and a capacitively coupled fast output. These microcells are arranged in a close-packed array with all of the like terminals

(e.g. all of the anodes) summed together (Figure 10). The array of microcells can thus be considered as a single photodiode sensor with three terminals: anode, cathode and fast output, as shown in Figure 11.



Figure 10. Simplified Circuit Schematic of the ON Semiconductor SiPM showing only a 12 Microcell Example. Typically, SiPM Sensors have Hundreds or Thousands of Microcells



Figure 9. Circuit Schematic of the ON Semiconductor SiPM Microcell, showing Details of the Fast Output



Figure 11. ON Semiconductor SiPM Component Symbol

TILING OF THE TSV PACKAGE

For the J-Series, ON Semiconductor has developed a market-leading, high-performance package using a TSV process. It is a chip-scale package that is compatible with lead-free, reflow soldering processes. The glass cover is ideal for coupling to scintillators or fibre optic elements.

The dead-space between the sensor active area and the edge of the package has been minimized, resulting in a package that can be tiled on 4 sides with high fill-factor.

This allows multiple sensors to be configured into unique layouts for a wide range of custom applications. The distance between sensor packages can be as little as 200 μm when tiled, but actual alignment and placement tolerances will depend on the accuracy of the user's assembly process. An [Application Note](#) is available that gives advice on creating arrays of the TSV sensors.

J-Series SiPM Sensors

PACKAGE DIMENSIONS

(All Dimensions in mm)

MicroFJ-300XX-TSV

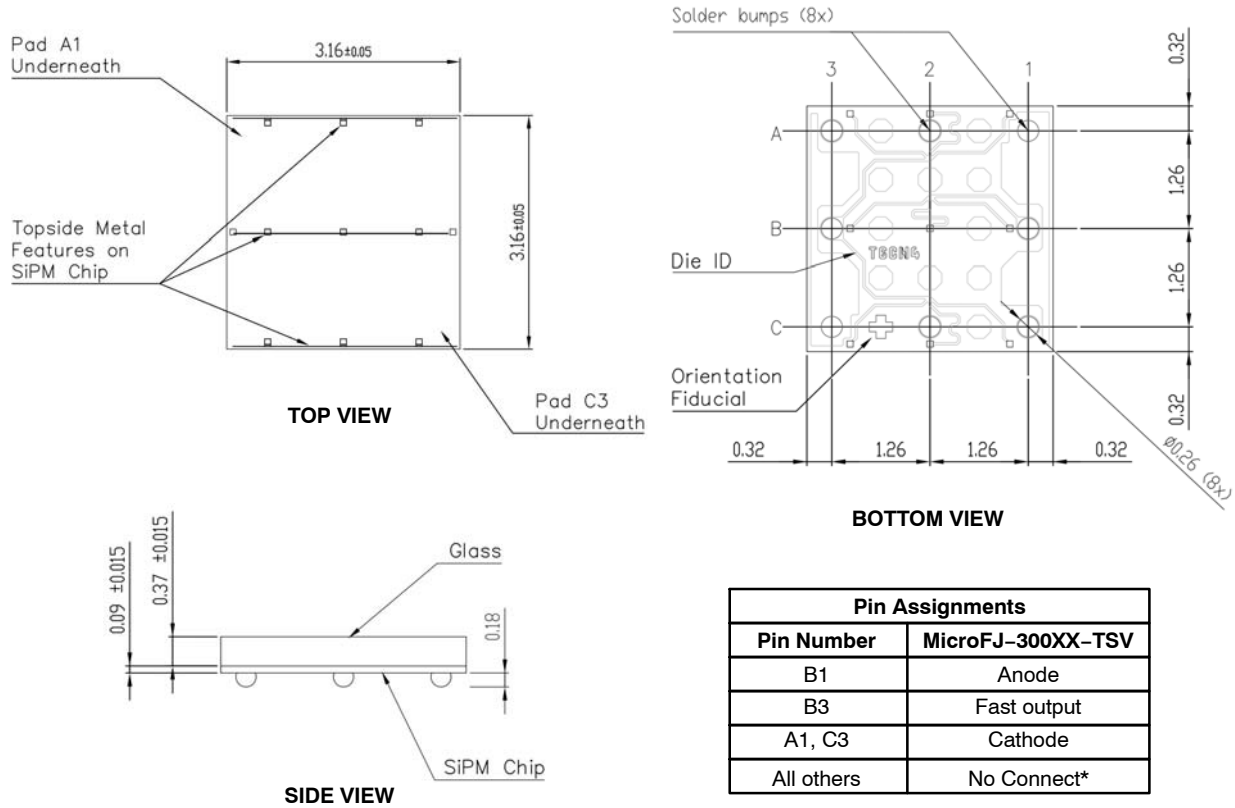

*The 'No Connect' pins are electrically isolated and should be soldered to a ground (or bias) plane to help with heat dissipation.

The MicroFJ-300XX-TSV-A2 CAD, and solder footprint, is available to download [here](#).



J-Series SiPM Sensors

PACKAGE DIMENSIONS

(All Dimensions in mm)

MicroFJ-40035-TSV



BOTTOM VIEW



SIDE VIEW

| Pin Assignments | |
|-----------------|-------------------|
| Pin Number | MicroFJ-40035-TSV |
| B1, C1 | Anode |
| B4, C4 | Fast output |
| A1, D4 | Cathode |
| All others | No Connect* |

*The 'No Connect' pins are electrically isolated and should be soldered to a ground (or bias) plane to help with heat dissipation.

The MicroFJ-40035-TSV CAD, and solder footprint, is available to download [here](#).

J-Series SiPM Sensors

PACKAGE DIMENSIONS

(All Dimensions in mm)

MicroFJ-60035-TSV

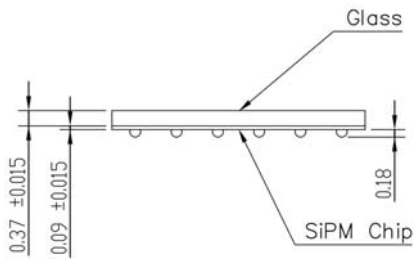

| Pin Assignments | |
|-----------------|-------------------|
| Pin Number | MicroFJ-60035-TSV |
| C1, D1 | Anode |
| A1, F6 | Cathode |
| C6, D6 | Fast output |
| All others | No Connect* |

*The 'No Connect' pins are electrically isolated and should be soldered to a ground (or bias) plane to help with heat dissipation.

The MicroFJ-60035-TSV CAD, and solder footprint, is available to download [here](#).

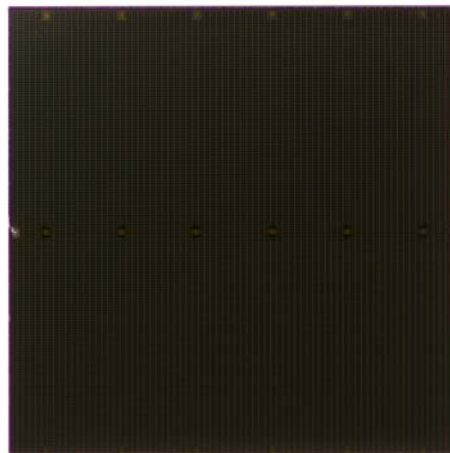
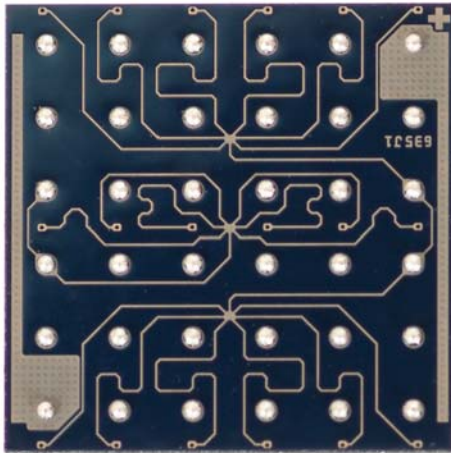

J-Series SiPM Sensors

MicroFJ-SMA-60035 Board



The complete CAD for the SMA boards can be downloaded from the website: [3 mm](#), [4 mm](#) and [6 mm](#) versions.

MicroFJ-SMTPA-60035 Board

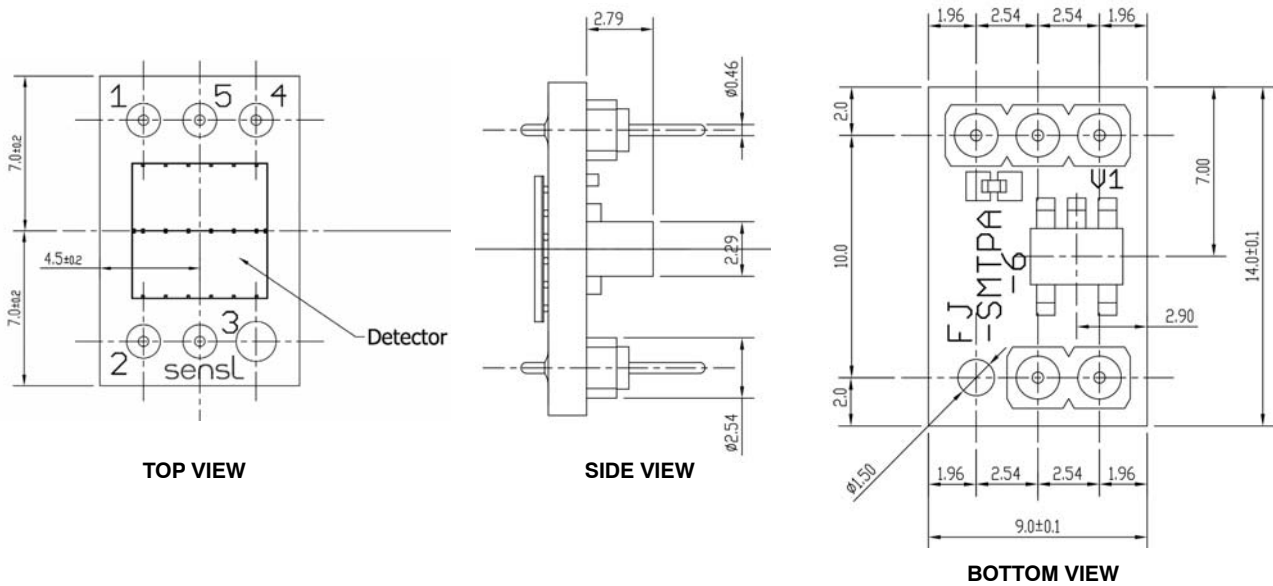

The complete CAD for the SMTPA boards can be downloaded from the website: [3 mm](#) and [6 mm](#) versions.

J-Series SiPM Sensors

ORDERING INFORMATION

Table 5. ORDERING INFORMATION

| Product Code | Microcell Size (No. of Microcells) | Sensor Active Area | Description | Delivery Option (Note 9) |
|--------------------------|---------------------------------------|--------------------------|--|--------------------------------|
| 3 mm Sensors | | | | |
| MICROFJ-30020-TSV | 20 μm (14,410) | 3.07 \times 3.07 mm | 4-side tileable, chip scale package with through-silicon vias (TSV) | TR1, TR |
| MICROFJ-SMA-30020-GEVB | | | TSV sensor mounted onto a PCB with three SMA connectors for bias, standard output and fast output | PK |
| MICROFJ-SMTPA-30020-GEVB | | | TSV sensor mounted onto a pin adapter board | PK |
| MICROFJ-30035-TSV | 35 μm (5,676) | | 4-side tileable, chip scale package with through-silicon vias (TSV) | TR1, TR |
| MICROFJ-SMA-30035-GEVB | | | TSV sensor mounted onto a PCB with three SMA connectors for bias, standard output and fast output | PK |
| MICROFJ-SMTPA-30035-GEVB | | | TSV sensor mounted onto a pin adapter board | PK |
| 4 mm Sensors | | | | |
| MICROFJ-40035-TSV | 35 μm (9,260) | 3.93 \times 3.93 mm | 4-side tileable, chip scale package with through-silicon vias (TSV) | TR1, TR |
| MICROFJ-SMA-40035-GEVB | | | TSV sensor mounted onto a PCB with three SMA connectors for bias, standard output and fast output. | PK |
| 6 mm Sensors | | | | |
| MICROFJ-60035-TSV | 35 μm (22,292) | 6.07 \times 6.07 mm | 4-side tileable, chip scale package with through-silicon vias (TSV) | TR1, TR |
| MICROFJ-SMA-60035-GEVB | | | TSV sensor mounted onto a PCB with three SMA connectors for bias, standard output and fast output | PK |
| MICROFJ-SMTPA-60035-GEVB | | | TSV sensor mounted onto a pin adapter board | PK |

9. The two-letter delivery option code should be appended to the order number, e.g.) to receive a MICROFJ-60035-TSV on tape and reel, use MICROFJ-60035-TSV-TR. The codes are as follows:
 PK = ESD Package
 TR1 = Tape
 TR = Tape and Reel

There is a minimum order quantity (MOQ) of 3000 for the tape and reel (TR) option. Quantities less than this are available on tape (-TR1). The TR option is only available in multiples of the MOQ.

J-Series SiPM Sensors

SensL is a registered trademark of Semiconductor Components Industries, LLC (SCILLC) or its subsidiaries in the United States and/or other countries.

ON Semiconductor and  are trademarks of Semiconductor Components Industries, LLC dba ON Semiconductor or its subsidiaries in the United States and/or other countries. ON Semiconductor owns the rights to a number of patents, trademarks, copyrights, trade secrets, and other intellectual property. A listing of ON Semiconductor's product/patent coverage may be accessed at www.onsemi.com/site/pdf/Patent-Marking.pdf. ON Semiconductor reserves the right to make changes without further notice to any products herein. ON Semiconductor makes no warranty, representation or guarantee regarding the suitability of its products for any particular purpose, nor does ON Semiconductor assume any liability arising out of the application or use of any product or circuit, and specifically disclaims any and all liability, including without limitation special, consequential or incidental damages. Buyer is responsible for its products and applications using ON Semiconductor products, including compliance with all laws, regulations and safety requirements or standards, regardless of any support or applications information provided by ON Semiconductor. "Typical" parameters which may be provided in ON Semiconductor data sheets and/or specifications can and do vary in different applications and actual performance may vary over time. All operating parameters, including "Typicals" must be validated for each customer application by customer's technical experts. ON Semiconductor does not convey any license under its patent rights nor the rights of others. ON Semiconductor products are not designed, intended, or authorized for use as a critical component in life support systems or any FDA Class 3 medical devices or medical devices with a same or similar classification in a foreign jurisdiction or any devices intended for implantation in the human body. Should Buyer purchase or use ON Semiconductor products for any such unintended or unauthorized application, Buyer shall indemnify and hold ON Semiconductor and its officers, employees, subsidiaries, affiliates, and distributors harmless against all claims, costs, damages, and expenses, and reasonable attorney fees arising out of, directly or indirectly, any claim of personal injury or death associated with such unintended or unauthorized use, even if such claim alleges that ON Semiconductor was negligent regarding the design or manufacture of the part. ON Semiconductor is an Equal Opportunity/Affirmative Action Employer. This literature is subject to all applicable copyright laws and is not for resale in any manner.

PUBLICATION ORDERING INFORMATION

LITERATURE FULFILLMENT:

Literature Distribution Center for ON Semiconductor
19521 E. 32nd Pkwy, Aurora, Colorado 80011 USA
Phone: 303-675-2175 or 800-344-3860 Toll Free USA/Canada
Fax: 303-675-2176 or 800-344-3867 Toll Free USA/Canada
Email: orderlit@onsemi.com

N. American Technical Support: 800-282-9855 Toll Free
USA/Canada
Europe, Middle East and Africa Technical Support:
Phone: 421 33 790 2910

ON Semiconductor Website: www.onsemi.com

Order Literature: <http://www.onsemi.com/orderlit>

For additional information, please contact your local
Sales Representative

Компания «Life Electronics» занимается поставками электронных компонентов импортного и отечественного производства от производителей и со складов крупных дистрибьюторов Европы, Америки и Азии.

С конца 2013 года компания активно расширяет линейку поставок компонентов по направлению коаксиальный кабель, кварцевые генераторы и конденсаторы (керамические, пленочные, электролитические), за счёт заключения дистрибьюторских договоров

Мы предлагаем:

- Конкурентоспособные цены и скидки постоянным клиентам.
- Специальные условия для постоянных клиентов.
- Подбор аналогов.
- Поставку компонентов в любых объемах, удовлетворяющих вашим потребностям.
- Приемлемые сроки поставки, возможна ускоренная поставка.
- Доставку товара в любую точку России и стран СНГ.
- Комплексную поставку.
- Работу по проектам и поставку образцов.
- Формирование склада под заказчика.
- Сертификаты соответствия на поставляемую продукцию (по желанию клиента).
- Тестирование поставляемой продукции.
- Поставку компонентов, требующих военную и космическую приемку.
- Входной контроль качества.
- Наличие сертификата ISO.

В составе нашей компании организован Конструкторский отдел, призванный помогать разработчикам, и инженерам.

Конструкторский отдел помогает осуществить:

- Регистрацию проекта у производителя компонентов.
- Техническую поддержку проекта.
- Защиту от снятия компонента с производства.
- Оценку стоимости проекта по компонентам.
- Изготовление тестовой платы монтаж и пусконаладочные работы.



Тел: +7 (812) 336 43 04 (многоканальный)

Email: org@lifeelectronics.ru