

# AXL E EC DI16 M12 6M

**Axioline E EtherCAT® device, metal housing,  
16 inputs, 24 V DC,  
M12 fast connection technology**



Data sheet  
8536\_en\_03

© PHOENIX CONTACT 2015-09-22

## 1 Description

The Axioline E device is designed for use within an EtherCAT® network.

It is used to acquire digital signals.

The device is designed for use in systems manufacturing.

It is suitable for use without a control cabinet under harsh industrial conditions.

The Axioline E device can be used on tool platforms, directly on welding robots or in conveying technology, for example.

EtherCAT® is a registered trademark and patented technology, licensed by Beckhoff Automation GmbH, Germany.

### EtherCAT® features

- 2 Ethernet-Ports
- Automatic addressing
- Identification:
  - Rotary coding switch for assigning the ID for the "Explicit Device ID" mechanism
  - Configured Second Station Alias

- Hot Connect
- Acyclic data communication (CoE and FoE mailbox protocols)
- Supports the EtherCAT® cycle time of min. 100 µs
- Supports distributed clocks (jitter << 1 µs)
- Specification: ETG.1000 V1.02
- Device description by means of ESI
- Firmware can be updated

### Axioline E features

- Connection to EtherCAT® network using M12 connectors (D-coded)
- Transmission speed 100 Mbps
- Connection of digital sensors using M12 connectors (A-coded)
- Diagnostic and status indicators
- Short-circuit and overload protection of the sensor supply
- IP65/67 degree of protection



This data sheet is only valid in association with the associated user manual. Make sure you always use the latest documentation.

It can be downloaded from the product at [phoenixcontact.net/products](http://phoenixcontact.net/products).



### Abbreviations used

- CoE: CAN application layer over EtherCAT®
- DC: distributed clocks
- FoE: file access over EtherCAT®

<b>2</b>	<b>Table of contents</b>	
1	Description .....	1
2	Table of contents .....	2
3	Ordering data .....	3
4	Technical data .....	4
5	Internal circuit diagram .....	7
6	Pin assignment .....	8
7	Connection example.....	10
8	Connection notes .....	10
9	Identification .....	11
10	Local status and diagnostic indicators .....	12
11	EtherCAT® .....	14
12	EtherCAT® object dictionary (CoE objects) .....	14
13	EtherCAT® State Machine: AL Objects .....	19
14	Process data.....	20
15	Emergency messages .....	21
16	Synchronization.....	22
17	Restoring the default settings .....	23
18	Firmware started.....	23
19	Firmware update.....	23
20	Device description file (ESI).....	23
21	Endianness.....	23

### 3 Ordering data

Description	Type	Order No.	Pcs. / Pkt.
Axioline E-EtherCAT® device in a metal housing with 16 digital inputs, 24 V DC, M12 fast connection technology	AXL E EC DI16 M12 6M	2701526	1
Accessories	Type	Order No.	Pcs. / Pkt.
An M12 screw plug for the unoccupied M12 sockets of the sensor/actuator cable, boxes and flush-type connectors (Protection and sealing elements)	PROT-M12	1680539	5
Mounting plate for Axioline E metal devices (Assembly)	AXL E MP 60	2701761	1
Snap-in markers, Sheet, white, unlabeled, can be labeled with: THERMOMARK CARD, BLUEMARK CLED, BLUEMARK LED, TOPMARK LASER, Mounting type: snapped into marker carrier, Lettering field: 7 x 10 mm (Marking)	UCT-EM (7X10)	0830765	10
Documentation	Type	Order No.	Pcs. / Pkt.
User manual, English: Axioline E: system and installation	UM EN AXL E SYS INST	-	-
Application note, English: Updating the firmware of Axioline E-EtherCAT® devices with TwinCAT®	AH EN FIRMWARE UPDATE AXL E EC	-	-

#### Additional ordering data

For additional accessories, visit [phoenixcontact.net/products](http://phoenixcontact.net/products).

## 4 Technical data

### Dimensions (nominal sizes in mm)

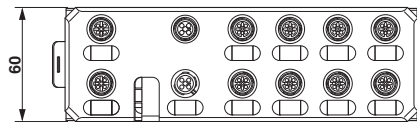
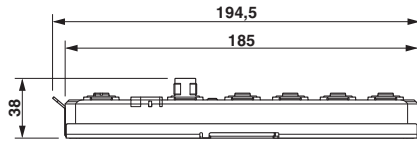

Width	60 mm
Height	185 mm
Depth	38 mm
Note on dimensions	The height is 194.5 mm including the mounting plate. With fixing clips pulled out, the height is 212 mm. The depth is 38 mm including the mounting plate (30.5 mm without the mounting plate).

### General data

Housing material	Zinc die-cast
Weight	750 g
Ambient temperature (operation)	-25 °C ... 60 °C



**CAUTION: Risk of burns**

If the device is used at an ambient temperature above 50°C, the contact temperature of metal surfaces may exceed 70°C.

Ambient temperature (storage/transport)	-25 °C ... 85 °C
Permissible humidity (operation)	5 % ... 95 %
Permissible humidity (storage/transport)	5 % ... 95 %
Air pressure (operation)	70 kPa ... 106 kPa (up to 3000 m above sea level)
Air pressure (storage/transport)	70 kPa ... 106 kPa (up to 3000 m above sea level)
Degree of protection	IP65/IP67
Protection class	III, IEC 61140, EN 61140, VDE 0140-1

### Connection data

Connection method	M12 connector
-------------------	---------------

### Interface EtherCAT®

Number	2
Connection method	M12 connectors, D-coded
Designation connection point	Copper cable
Number of positions	4
Transmission speed	100 MBit/s (with autonegotiation)
Cycle Time	< 100 µs

### EtherCAT®

Equipment type	EtherCAT® slave
Mailbox protocols	CANopen® over EtherCAT®, File access over EtherCAT®
Type of addressing	Auto-increment addressing Fixed position addressing Logical addressing
Specification	ETG.1000 V1.02

### Supply: Module electronics and sensors (U<sub>S</sub>)

Connection method	M12 connector (T-coded)
Number of positions	4
Supply voltage	24 V DC
Nominal supply voltage range	18 V DC ... 31.2 V DC (including all tolerances, including ripple)
Typical current consumption	190 mA ±15 % (at 24 V DC)
Current consumption	max. 12 A

### Supply: Actuators (U<sub>A</sub>) for additional devices

Connection method	M12 connector (T-coded)
Number of positions	4
Supply voltage	24 V DC
Nominal supply voltage range	18 V DC ... 31.2 V DC (including all tolerances, including ripple)
Typical current consumption	3 mA ±15 % (at 24 V DC)
Current consumption	max. 12 A

### Digital inputs

Number of inputs	16 (EN 61131-2 types 1 and 3)
Connection method	M12 connector, double occupancy
Connection method	2, 3, 4-wire
Nominal input voltage	24 V DC
Nominal input current	typ. 3 mA
Sensor current per channel	typ. 0.75 mA (from U <sub>S</sub> )
Total sensor current	max. 1.2 A (per device)
Input voltage range "0" signal	-30 V DC ... 5 V DC
Input voltage range "1" signal	11 V DC ... 30 V DC
Input filter time	< 1000 µs
Permissible conductor length to the sensor	30 m
Overload protection, short-circuit protection of sensor supply	Yes

**Electrical isolation/isolation of the voltage areas**

Test section	Test voltage
24 V supply (communications power and sensor supply, digital inputs)/ bus connection (Ethernet 1)	500 V AC, 50 Hz, 1 min
24 V supply (communications power and sensor supply, digital inputs)/ bus connection (Ethernet 2)	500 V AC, 50 Hz, 1 min
24 V supply (communications power and sensor supply, digital inputs)/FE	500 V AC, 50 Hz, 1 min
Bus connection (Ethernet 1)/FE	500 V AC, 50 Hz, 1 min
Bus connection (Ethernet 2)/FE	500 V AC, 50 Hz, 1 min
Bus connection (Ethernet 1)/bus connection (Ethernet 2)	500 V AC, 50 Hz, 1 min
24 V supply (actuator supply)/24 V supply (communications power and sensor supply, digital inputs)	500 V AC, 50 Hz, 1 min
24 V supply (actuator supply)/bus connection (Ethernet 1)	500 V AC, 50 Hz, 1 min
24 V supply (actuator supply)/bus connection (Ethernet 2)	500 V AC, 50 Hz, 1 min
24 V supply (actuator supply)/FE	500 V AC, 50 Hz, 1 min

**Mechanical tests**

Vibration resistance in acc. with EN 60068-2-6/IEC 60068-2-6	5g
Shock in acc. with EN 60068-2-27/IEC 60068-2-27	30g, 11 ms period, half-sine shock pulse
Continuous shock according to EN 60068-2-27/IEC 60068-2-27	10g

**Conformance with EMC Directive 2004/108/EC**

**Noise immunity test in accordance with EN 61000-6-2**

Electrostatic discharge (ESD) EN 61000-4-2/IEC 61000-4-2	Criterion B; 6 kV contact discharge, 8 kV air discharge
Electromagnetic fields EN 61000-4-3/IEC 61000-4-3	Criterion A; Field intensity: 10 V/m
Fast transients (burst) EN 61000-4-4/IEC 61000-4-4	Criterion B, 2 kV
Transient surge voltage (surge) EN 61000-4-5/IEC 61000-4-5	Criterion B; DC supply lines: $\pm 0.5$ kV/ $\pm 0.5$ kV (symmetrical/asymmetrical)
Conducted interference EN 61000-4-6/IEC 61000-4-6	Criterion A; Test voltage 10 V

**Noise emission test as per EN 61000-6-4**

Radio interference properties EN 55022	Class A
--	---------

**Approvals**

For the latest approvals, please visit [phoenixcontact.net/products](http://phoenixcontact.net/products).

## 5 Internal circuit diagram

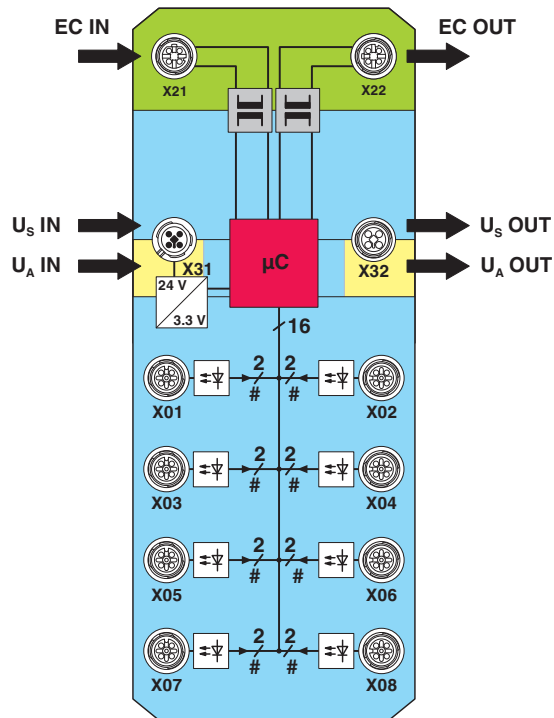

Key:



Transmitter with electrical isolation



Power supply unit with electrical isolation



Microcontroller



Digital input



LED

Figure 1 Internal wiring of connections

Key:

Green area:	Network
Blue area:	$U_S$
Yellow area:	$U_A$

## 6 Pin assignment

### 6.1 EtherCAT® and power supply connection



Figure 2 Connections for EtherCAT® and voltage supply

Designation	Meaning
EC IN (X21)	EtherCAT® IN
EC OUT (X22)	EtherCAT® OUT
U <sub>S</sub> IN (X31)	Power supply IN (logic and sensors)
U <sub>A</sub> IN (X31)	Power Supply IN (actuators) for additional devices
U <sub>S</sub> OUT (X32)	Power supply OUT for additional devices
U <sub>A</sub> OUT (X32)	Power supply OUT for additional devices



Ground the device by means of the mounting screws of the fixing clips or the mounting plate or the DIN rail.

### 6.2 EtherCAT® pin assignment



Figure 3 Pin assignment, D-coded

Pin	EC IN (X21)	EC OUT (X22)
1	TX+	TX+
2	RX+	RX+
3	TX-	TX-
4	RX-	RX-



The shield is connected to FE in the device.



The thread is used for additional shielding.

### 6.3 Pin assignment of the power supply U<sub>S</sub>/U<sub>A</sub>

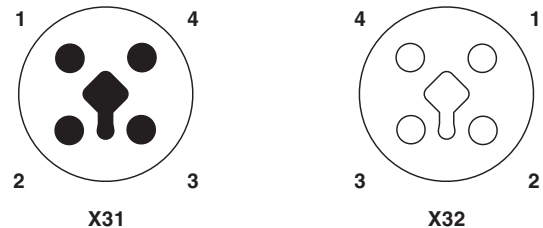

Figure 4 Pin assignment of the power supply, T-coded

Pin	IN	OUT	Conductor colors
1	+24 V DC (U <sub>S</sub> )	+24 V DC (U <sub>S</sub> )	Brown
2	GND (U <sub>A</sub> )	GND (U <sub>A</sub> )	White
3	GND (U <sub>S</sub> )	GND (U <sub>S</sub> )	Blue
4	+24 V DC (U <sub>A</sub> )	+24 V DC (U <sub>A</sub> )	Black



6.4 Input connection

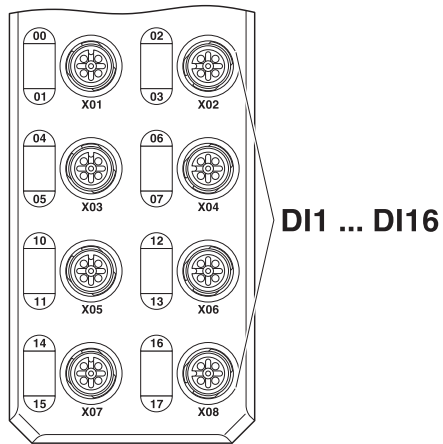

Figure 5 Input connections

Designation	Meaning
DI1 ... DI16 (X01 ... X08)	Inputs 1 ... 16

6.5 Pin assignment of the inputs



Figure 6 Pin assignment of the inputs, A-coded

Pin	Input socket
1	+24 V DC ( $U_S$ )
2	Input 2, 4, 6, ... 16
3	GND
4	Input 1, 3, 5, ... 15
5	FE

## 7 Connection example



Figure 7 Typical connection of sensors

## 8 Connection notes



**Note: data corruption or loss**

Implement the FE connection using mounting screws, in order to ensure immunity to interference.



**NOTE: device damage**

To ensure IP65/IP67 protection, cover unused sockets with protective caps.



**NOTE: Damage to the electronics**

Only supply the sensors with the voltage  $U_S$  provided at the terminal points.



**NOTE: Damage to the electronics**

Observe the correct polarity of the supply voltages  $U_S$  and  $U_A$  in order to prevent damage to the device.



**NOTE: Malfunction**

When connecting the sensors, observe the assignment of the connections to the EtherCAT<sup>®</sup> input data.



Secure the device to a level surface or to a profile. Do not use this device to bridge gaps, in order to prevent forces being transmitted via the device.



Use standard M5 screws with toothed lock washer and self-locking nuts. Observe the maximum torque of the screws.

## 9 Identification

In the case of EtherCAT® devices, a distinction is made between address assignment and identification.

**Addresses** are used for direct communication between the EtherCAT® master and the relevant slave. In doing so, the master assigns each slave a unique 16-bit address.

**Identifications** are used to uniquely identify a slave in an EtherCAT® network.

Identifications for AXL E EC devices are:

- Device Identification Value
- Configured Second Station Alias

### 9.1 Configuration via rotary encoding switch (Device Identification Value)

You can configure the address assignment using the rotary coding switch.

After modifying the switch position, restart the device, as the modification to the switch position does not take effect during operation.

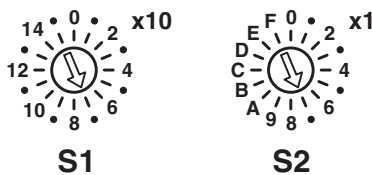

Figure 8 Rotary encoding switch

The code results from the sum of S1 x 10 plus S2 x 1. The image shows code 77 (7 x 10 + 7).

S1	S2	Code	Function
0 ... 15	0 ... 09	01 ... 159	Device Identification Value
Other			Reserved

#### Switch position 01 ... 159

Set the EtherCAT® explicit device identification manually with this switch position.



The device is ready for operation after powering up, as soon as the RDY LED lights up green.  
 A connection to the device cannot be established in the firmware startup phase.  
 As soon as the RDY LED lights up green, a new switch position can be selected on the rotary coding switch and the device can be restarted.

#### Reserved/invalid switch position

The device starts with the previous settings, e.g., with the settings that were valid before the device was restarted.

#### 9.2 Configured Second Station Alias

For information on how to use the “Configured Second Station Alias” identification, please consult your configuration software.

#### 9.3 Hot Connect

The Hot Connect functionality allows preconfigured sections to be removed from or added to the data traffic before the start or during operation of the system. This can be carried out by disconnecting/connecting the communication line or by switching a device on/off, for example. This is called “flexible topology” or “Hot Connect”.

## 10 Local status and diagnostic indicators

### 10.1 Indicators for EtherCAT® and power supply



Figure 9 Indicators for EtherCAT® and power supply

Designation	Color	Meaning	State	Description
L/A	Green	Link/Activity	Green ON	Connection present at EC IN/EC OUT.
			OFF	Connection not present at EC IN/EC OUT.
RDY	Green/ yellow/ red	Ready	Green ON	Device is ready for operation.
			Yellow flashing	Firmware update is being performed.
			Flashing green/ yellow	Over- or undervoltage at $U_S$ Temperature of the device is in the critical area. And red US LED: sensor supply overload
			Red ON	Rotary encoding switches are set to an invalid/reserved position.
			OFF	Device is not ready for operation.
RUN	Green	RUN	OFF	Device is in the Init state.
			Flashing slowly (2.5 Hz)	Device is in the Pre-Operational state.
			Single pulse	200 ms on, 1000 ms off; device is in the Safe-Operational state.
			Green ON	Device is in the Operational state.
			Flashing (10 Hz)	Device is in the Bootstrap state.

Designation	Color	Meaning	State	Description
ERR	Red	Error	ON	Critical error in the device
			Flashing slowly (2.5 Hz)	Configuration error, a state transition initiated by the master cannot be executed.
			Single pulse	Local application error
			Double pulse	Watchdog timeout. The EtherCAT <sup>®</sup> watchdog for monitoring the process data has elapsed.
			OFF	No error
US	Green/red	U <sub>Sensorik</sub>	Green ON	Communications power/sensor voltage present
			OFF	Communications power/sensor voltage not present or too low.
			Red ON	Sensor voltage overload
UA	Green	U <sub>Aktorik</sub>	ON	Actuator voltage present.
			OFF	Actuator voltage not present.

### 10.2 Input indicators

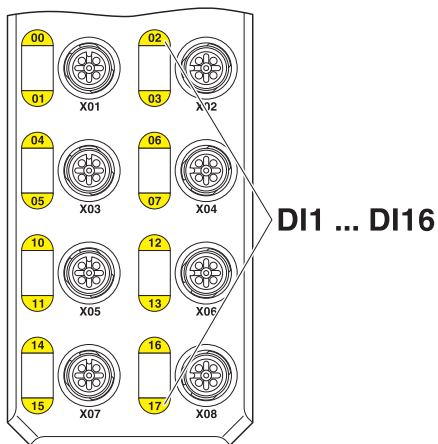

Figure 10 LEDs of the inputs

Designation	Color	Meaning	State	Description
00 ... 07, 10 ... 17	Yellow	Status of the inputs	ON	Input is set.
			OFF	Input is not set.



The numbering of the LEDs is as follows: the first number specifies the byte, the second number specifies the bit.

## 11 EtherCAT®

The CAN application layer over EtherCAT® (CoE) mailbox protocol is the basis of the Device Profile and enables parameterization of EtherCAT® devices via the object dictionary. The object dictionary is accessed via CoE using Service Data Object (SDO) services.

The objects implemented on the device are described in the “EtherCAT® object dictionary” section.

## 12 EtherCAT® object dictionary (CoE objects)

The device object dictionary contains objects which can be addressed via SDO services. The device supports standard objects and manufacturer-specific objects. The standard objects are described in ETG.1000.6 (Application Layer Protocol Specification). The manufacturer-specific objects are listed below.

The objects are addressed using a combination of index and subindex. Subindex 0 lists the number of subindices.

The following applies for the tables below:

Length = Length of the elements in bytes                      R = Read  
 Rights = Access rights    W = Write

Index (hex)	Object name	Data type	Rights
<b>Device Identity Objects (1)</b>			
1000	Device Type	UINT32	RO
1008	Manufacturer Device Name	STRING	RO
1009	Manufacturer Hardware Version	STRING	RO
100A	Manufacturer Software Version	STRING	RO
1018	Identity	IDENTITY	RO
<b>Sync Manager Objects</b>			
1C00	Sync Manager Communication Type	UINT8	RO
1C10	Sync Manager 0 PDO Assignment (Mail out control register)	UINT16	RO
1C11	Sync Manager 1 PDO Assignment (Mail out control register)	UINT16	RO
1C13	Sync Manager 3 PDO Assignment (Process data input control register)	UINT16	RO
1C32	Sync Parameter of SM2	SYNC_PAR	RO
1C33	Sync Parameter of SM3	SYNC_PAR	RO
<b>Device Identity Objects (2)</b>			
2001	Component Name	STRING	RO
2002	Vendor Name	STRING	RO
2003	Vendor URL	STRING	RO
2004	Order Number	STRING	RO
2005	Manufacturing Date	STRING	RO
2006	QS Date	STRING	RO
2007	Installation Location	STRING	R/W
2008	Operational Hours	UINT32	RO
2009	Service Date	STRING	RO
200A	Equipment Ident	STRING	R/W
<b>Reset Objects</b>			
2F00	Reset to Factory Settings	UINT8	R/W
<b>PDO Mapping Objects</b>			
1A00	TxPDO Mapping Digital Inputs	PDO Mapping	RO
1A01	RxPDO Mapping IO Status	PDO Mapping	RO
4000	Digital inputs	UINT8	RO
4001	IO Status	UINT32	RO

### 12.1 Device Identity Objects (device rating plate)

The device has objects for identification. They contain information about the manufacturer and device and make up the device rating plate.

The objects that form the device rating plate are described below.

Index (hex)	Subindex	Object name	Data type	Rights	Meaning/value
1000	-	Device Type	UINT32	RO	00000000 <sub>hex</sub> (0)
1008	-	Manufacturer Device Name	STRING	RO	Product name
1009	-	Manufacturer Hardware Version	STRING	RO	Hardware version, version ID
100A	-	Manufacturer Software Version	STRING	RO	Firmware version, version ID
1018	Identity				
	00	Number of entries	UINT8	RO	Number of object subindices
	01	Vendor ID	UINT32	RO	00000084 <sub>hex</sub> (132)
	02	Product Code	UINT32	RO	Order No.
	03	Revision Number	UINT32	RO	Device revision, version ID
	04	Serial number	UINT32	RO	Serial number
2001	-	Component Name	STRING	RO	Digital EtherCAT <sup>®</sup> I/O devices
2002	-	Vendor Name	STRING	RO	Phoenix Contact
2003	-	Vendor URL	STRING	RO	www.phoenixcontact.com
2004	-	Order Number	STRING	RO	Order No.
2005	-	Manufacturing Date	STRING	RO	YYYY-MM-DD T HH:MM:SS Z (date and time of manufacture)
2006	-	QS Date	STRING	RO	YYYY-MM-DD T HH:MM:SS Z (date and time of final manufacturing test)
2007	-	Installation Location	STRING	R/W	User-defined device installation location
2008	-	Operational Hours	UINT32	RO	Operating hours counter
2009	-	Service Date	STRING	RO	YYYY-MM-DD T HH:MM:SS Z (date and time of a service)
200A	-	Equipment Ident	STRING	R/W	User-defined device name

### 12.2 Sync Manager Objects

The EtherCAT<sup>®</sup> protocol provides two types of communication, these are:

- Mailbox mode
- and buffered mode.

The mailbox mode is used for acyclic transmission of commands to slaves. If a slave receives a mailbox message, this must be processed first before anything else can be processed.

In contrast, the buffered mode enables the master and slave to use a shared data area. The master and slave can read or write data in this area (buffer) at any time.

The sync manager manages the data exchange for both processes to ensure there are no data collisions. A detailed description of all registers can be found in the "EtherCAT<sup>®</sup> Slave Controller" description from the EtherCAT<sup>®</sup> user organization ([www.EtherCAT.org](http://www.EtherCAT.org)).



### 12.3 Reset Objects

The device can be reset to its factory settings. To do so, use the following object:

Index (hex)	Subindex	Object name	Data type	Rights	Meaning/value
2F00	-	Reset to Factory Settings	UINT8	R/W	<b>00<sub>hex</sub> = Normal operation (default)</b>
					01 <sub>hex</sub> = Reset device
					Other = Reserved



The reset is carried out once the device is restarted.

### 12.4 PDO mapping objects

In addition to the cyclic input process data, the device is equipped with further status and diagnostics data that can be added to the cyclic process image. This data has a total length of 4 bytes (object 1A01<sub>hex</sub>).

#### PDO Mapping Register

Index (hex)	Subindex	Object name	Data type	Rights	Meaning/value	
1A00	<b>TxPDO mapping digital inputs</b>					
	00	Number of entries	UINT8	RO	02 <sub>hex</sub> (2)	
	01		UINT32	RO	Bit 31 ... bit 16	Index of the input data object (4000 <sub>hex</sub> )
					Bit 15 ... bit 8	Subindex of the input data object (01 <sub>hex</sub> )
					Bit 7 ... bit 0	Subindex length of the input data object (8)
	02		UINT32	RO	Bit 31 ... bit 16	Index of the input data object (4000 <sub>hex</sub> )
					Bit 15 ... bit 8	Subindex of the input data object (02 <sub>hex</sub> )
Bit 7 ... bit 0					Subindex length of the input data object (8)	
1A01	<b>TxPDO mapping IO status</b>					
	00		UINT8	RO	01 <sub>hex</sub> (1)	
	01		UINT32	RO	Bit 31 ... bit 16	Index of the IO status object (4001 <sub>hex</sub> )
					Bit 15 ... bit 8	Subindex of the IO status object (01 <sub>hex</sub> )
Bit 7 ... bit 0					Subindex length of the IO status object (32)	

PDO register

Index (hex)	Subindex	Object name	Data type	Rights	Meaning/value	
4000	<b>Digital inputs</b>					
	00	Number of entries	UINT8	RO	02 <sub>hex</sub> (2)	
	01	Digital inputs bit 0 ... bit 7	UINT8	RO	Bit 7 ... bit 0	Digital input 8 (X04.2) ... digital input 1 (X01.4)
	02	Digital inputs bit 8 ... bit 15	UINT8	RO	Bit 7 ... bit 0	Digital input 16 (X08.2) ... digital input 9 (X05.4)
4001	<b>IO status</b>					
	00	Number of entries	UINT8	RO	01 <sub>hex</sub> (1)	
	01		UINT32	RO	Bit 31 ... bit 16	Reserved
					Bit 5	Undervoltage of sensor supply
					Bit 4	Surge voltage of sensor supply

### 13 EtherCAT® State Machine: AL Objects

The device has a state machine, called the EtherCAT® State Machine (ESM).

The EtherCAT® master sends state change requests to the AL control register of the slave. The slave displays the current state in the AL status register and make additional error codes available in the AL status code register in the event of errors.

#### 13.1 AL control and AL status register

If the master writes to the AL control register, then the corresponding state transition is triggered in the device state machine by the slave. The AL status register reflects the current state of the slave.

Index (hex)	Object name	Data type	Rights	Meaning/value	
0120	AL Control	UINT16	R/W	Bit 0 ... bit 3	<b>State (AL status requested by master)</b>
					01 <sub>hex</sub> = Init (I)
					02 <sub>hex</sub> = Pre-Operational (P)
					03 <sub>hex</sub> = Bootstrap (B)
					04 <sub>hex</sub> = Safe-Operational (S)
				08 <sub>hex</sub> = Operational (O)	
				Bit 4	<b>Acknowledge (Master acknowledge bit)</b>
					00 <sub>hex</sub> = Parameter Change of the AL Status Register will be unchanged.
					01 <sub>hex</sub> = Parameter Change of the AL Status Register will be reset.
				Bit 5 ... bit 7	Reserved
00 <sub>hex</sub> = Shall be zero					
0130	AL Status	UINT16	RO	Bit 0 ... bit 3	<b>AL Status (AL status requested by master)</b>
					01 <sub>hex</sub> = Init (I)
					02 <sub>hex</sub> = Pre-Operational (P)
					03 <sub>hex</sub> = Bootstrap (B)
					04 <sub>hex</sub> = Safe-Operational (S)
				08 <sub>hex</sub> = Operational (O)	
				Bit 4	<b>Change (Error Flag, Master acknowledge bit)</b>
					00 <sub>hex</sub> = Confirmation of state in AL Control Register
					01 <sub>hex</sub> = A change has happened or an error occurred.
				Bit 5 ... bit 7	Reserved
Bit 8 ... bit 15	<b>Application Specific</b>				
	Reserved				
0134	AL Status Code	UINT16	RO	Bit 0 ... bit 15	All Status Code (send by slave)

### 13.2 AL Status Code Register

If the state transition requested by the master is not possible, then the slave sets an error flag in the AL status register (bit 4) and writes an error code to the AL status code register.

AL status code (hex)	Description	State or transition	Resulting state
0000	No error	Any	Current state
0001	Unspecified error	Any	Any + E
0011	Invalid requested state change	I→S, I→O, P→O O→B, S→B, P→B	Current state + E
0012	Unknown requested state	Any	Current state + E
0015	Invalid Mailbox Configuration for Bootstrap	I→B	I + E
0016	Invalid Mailbox Configuration for Pre-Operational State	I→P	I + E
0017	Invalid Sync Manager Configuration	P→S, S→O	Current state + E
001B	Sync Manager Watchdog	O, S	S + E
001D	Invalid output configuration	O, S P→S	S + E P + E
001E	Invalid input configuration	O, S, P→S	P + E

## 14 Process data

### 14.1 TxPDO Mapping Digital Inputs

Byte	Input process data															
	Byte 0								Byte 1							
Bit	7	6	5	4	3	2	1	0	7	6	5	4	3	2	1	0
IN	07	06	05	04	03	02	01	00	17	16	15	14	13	12	11	10
Connection	X04		X03		X02		X01		X08		X07		X06		X05	
Pin	2	4	2	4	2	4	2	4	2	4	2	4	2	4	2	4
DI	8	7	6	5	4	3	2	1	16	15	14	13	12	11	10	9

Key:

- Bit: Process data assignment
- IN: LED marking
- DI: Input of the device

### 14.2 TxPDO Mapping IO Status

Bit 31 ... bit 6	Bit 5	Bit 4	Bit 3	Bit 2	Bit 1	Bit 0
Reserved	Supply of the module electronics and sensors (U <sub>S</sub> )		Reserved			
Reserved	Undervoltage	Overload	Reserved			

## 15 Emergency messages

Emergency messages are messages that are actively sent from the device to the EtherCAT<sup>®</sup> master if certain events/problems occur. They are an unverified service which is based on CoE. In this way, all errors can be indicated to the master by the slave. This takes the form of messages which are specified in ETG.1000.6.

An emergency message is structured as follows:

CoE emergency message		
2 bytes	1 byte	5 bytes
Error code	Error register	Diagnostic data

The following emergency messages are supported by the device:

Error code (hex)	Error register	Diagnostic data (hex)	Localization	Meaning
3001	Bit 2 set	00, 01, 00, 00	Device level	Supply voltage overcurrent
3002	Bit 2 set	00, 02, 00, 00	Device level	Supply surge voltage
3003	Bit 2 set	00, 03, 00, 00	Device level	Supply undervoltage
4001	Bit 4 set	00, 06, 00, 00	Device level	Overtemperature



The device sends emergency messages for an incoming and outgoing error. Once the problem has been solved, an emergency message with the error code 0000<sub>hex</sub> (reset error) is sent by the slave. The value of the corresponding bit in the error register is then 0. The diagnostic data value does not change.

## 16 Synchronization

There are two modes for synchronizing the application which can be selected in the engineering system.

- SM Synchronous (process data update when an SM event occurs)
- DM Synchronous (process data update when a SYNC0 event occurs)

### 16.1 SM Synchronous

In this mode, the EtherCAT® communication system and the I/Os operate asynchronously. The I/Os are in Auto-Run mode and run with the minimum cycle time possible for the current device configuration. This mode is set by default in the device.

### 16.2 DC Synchronous

In this mode, the I/Os are synchronized with the EtherCAT® cycle.

The implemented Distributed Clocks unit is used for the time synchronization of processes.

In synchronous operation, the time points for outputting and reading the process data of the individual I/Os are synchronized with the higher-level network. EtherCAT® Distributed Clocks (DC) are used for this synchronization.

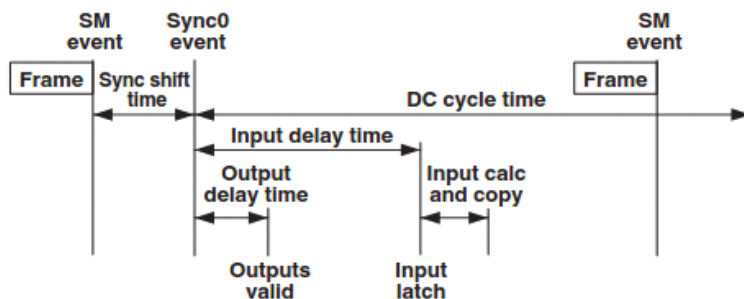

Figure 11 Synchronization model

The figure shows the synchronization model of the EtherCAT® device. The “DC Sync0 event” is used for synchronization. After the “Sync0 event” has occurred and a fixed delay time (output delay time) has elapsed, the process data is output.

The inputs are likewise read after a fixed delay (input delay time).



In order to activate DC Synchronous mode in TwinCAT®, it must be selected in the DC tab under Operation Mode and the slave must be started up again by means of the EtherCAT® master. TwinCAT® should be operated in Run mode.

## 17 Restoring the default settings

The following option is available for restoring the default settings:

- Write the value “1” to CoE object 2F00<sub>hex</sub>. After powering on again, the device is in the default settings.

## 18 Firmware started

Once you have connected the power, the firmware is started.

After completion of the boot process of the firmware, the RDY LED lights up green or flashes depending on the bus status.

## 19 Firmware update

It is possible to carry out a firmware update via EtherCAT®.

The File Access over EtherCAT® (FoE) mechanism is used for this, which is provided via your engineering system.

For detailed instructions for the firmware update with TwinCAT®, please refer to AH EN FIRMWARE UPDATE AXL E EC.

The application note can be downloaded at [phoenixcontact.net/products](http://phoenixcontact.net/products).

## 20 Device description file (ESI)

In the case of EtherCAT®, a device description file is required for various configuration tools.

This file is called EtherCAT® Slave Information (ESI).

A single ESI file is provided for all AxioLine E EtherCAT® devices.

## 21 Endianness

EtherCAT® uses Little Endian format. All variables, parameters, and data in this document are in Little Endian format (Intel), i.e., LSB/MSB.

Компания «Life Electronics» занимается поставками электронных компонентов импортного и отечественного производства от производителей и со складов крупных дистрибьюторов Европы, Америки и Азии.

С конца 2013 года компания активно расширяет линейку поставок компонентов по направлению коаксиальный кабель, кварцевые генераторы и конденсаторы (керамические, пленочные, электролитические), за счёт заключения дистрибьюторских договоров

Мы предлагаем:

- Конкурентоспособные цены и скидки постоянным клиентам.
- Специальные условия для постоянных клиентов.
- Подбор аналогов.
- Поставку компонентов в любых объемах, удовлетворяющих вашим потребностям.
- Приемлемые сроки поставки, возможна ускоренная поставка.
- Доставку товара в любую точку России и стран СНГ.
- Комплексную поставку.
- Работу по проектам и поставку образцов.
- Формирование склада под заказчика.
- Сертификаты соответствия на поставляемую продукцию (по желанию клиента).
- Тестирование поставляемой продукции.
- Поставку компонентов, требующих военную и космическую приемку.
- Входной контроль качества.
- Наличие сертификата ISO.

В составе нашей компании организован Конструкторский отдел, призванный помогать разработчикам, и инженерам.

Конструкторский отдел помогает осуществить:

- Регистрацию проекта у производителя компонентов.
- Техническую поддержку проекта.
- Защиту от снятия компонента с производства.
- Оценку стоимости проекта по компонентам.
- Изготовление тестовой платы монтаж и пусконаладочные работы.



Тел: +7 (812) 336 43 04 (многоканальный)  
Email: [org@lifeelectronics.ru](mailto:org@lifeelectronics.ru)