



CBM100S Series Application Note

AC-DC Switching Power Module

CBM100S Series

APPLICATION NOTE

Ver. 1.0





CBM100S Series

Application Note

Content

- 1.INTRODUCTION.....3
- 2. CBM100S SERIES CONVERTER FEATURES.....3
- 3. TECHNICAL SPECIFICATIONS.....4
- 4. MAIN FEATURES AND FUNCTION.....6
 - 4.1 *Operating Temperature Range*.....6
 - 4.2 *Output Protection*.....6
- 5. EMC & SAFETY.....6
- 6. APPLICATIONS.....6
 - 6.1 *CBM100S Series Derating Curve*.....6
 - 6.2 *Full-Brick Heat Sink*.....7
 - 6.3 *Test Set-Up*.....7
 - 6.4 *Output Ripple and Noise Measurement*.....7
 - 6.5 *Efficiency VS. Load*.....8
- 7. CBM100S SERIES MECHANICAL OUTLINE DIAGRAMS.....9
- 8. PART NUMBER.....10

Revision History

Revision Version	Date	Change Description	Signature
1.0	31 May 2013	Original Issue	SYLin



CBM100S Series

Application Note

1. Introduction

This application note describes the features and functions of Cincon's CBM100S series, the switching AC-DC power module. The CBM100S series with single output AC/DC power modules are highly efficient, reliable, compact, and highly power-density. The module is fully protected against short-circuit and over-voltage conditions. Cincon's world-class automated manufacturing methods, extensive test and qualified program, ensure that the CBM100S series power module is extremely reliable.

2. CBM100S Series Converter Features

- Universal Input Range 90~264Vac
- Full Load with Baseplate Cooled and no fan required
- Wide Operating Temperature Range
- 17mm Ultra Low Profile Package
- Safety Meets EN60950-1
- Built-in EN55022 Class B Filter
- Active PFC Meets EN61000-3-2
- High Efficiency Up to 90% Typical
- No Load Input Power Consumption <0.5W
- Over Temperature Protection
- Over Voltage Protection
- Over Current Protection



CBM100S Series

Application Note

3. Technical Specifications

(All specifications are typical at nominal input, full load at 25°C unless otherwise noted.)

PARAMETER	NOTES and CONDITIONS	Device	Min.	Typical	Max.	Units
ABSOLUTE RATINGS						
Input Voltage (Continuous)			90		264	Vac
Operating Temperature	See derating curve		-20		+85	°C
Storage Temperature			-40		+100	°C
Input/Output Isolation Voltage	1 minute		4242			Vdc
INPUT CHARACTERISTICS						
Operating Voltage Range			100		240	Vac
Input Frequency Range			47		63	Hz
Input Current	100% Load, Vin=100Vac				1.5	A
Leakage Current	Vin=264Vac				3.5	mA
Inrush Current	Vin=240Vac, cold start at 25°C.				100	A
OUTPUT CHARACTERISTICS						
Output Voltage Set Point	Vin=Nominal Line, Io=Io.max, Tc=25°C	CBM100S120	11.88	12	12.12	Vdc
		CBM100S240	23.76	24	24.24	
		CBM100S280	27.72	28	28.28	
		CBM100S360	35.64	36	36.36	
		CBM100S480	47.52	48	48.48	
Operating Output Current Range		CBM100S120			8.4	A
		CBM100S240			4.2	
		CBM100S280			3.6	
		CBM100S360			2.8	
		CBM100S480			2.1	
Holdup Time	Vin=115Vac			12		mS
OUTPUT VOLTAGE REGULATION						
Load Regulation	20% to 60% & 60% to 100% rated load				±1.0	%
Line Regulation	Vin= High Line to Low Line				±0.5	%
Over current Protection			130	160	200	%



CBM100S Series

Application Note

PARAMETER	NOTES and CONDITIONS	Device	Min.	Typical	Max.	Unit
Over Voltage Protection		CBM100S120		15		Vdc
		CBM100S240		33		
		CBM100S280		33		
		CBM100S360		45		
		CBM100S480		60		
Output Ripple and Noise	1. Add a 0.1uF ceramic capacitor and a 10uF aluminum electrolytic capacitor to output . 2. The bandwidth of oscilloscope is 20MHz . 3. Ambient temperature = 25°C	CBM100S120			120	mVp-p
		CBM100S240			240	
		CBM100S280			280	
		CBM100S360			360	
		CBM100S480			480	
Load Capacitance	1. Ambient temperature = 25°C 2. Input voltage is 115Vac and 230Vac 3. Output is rated load	CBM100S120			8570	uF
		CBM100S240			4220	
		CBM100S280			3600	
		CBM100S360			2860	
		CBM100S480			2100	
Efficiency	1. Output is Rated Load 2. Ambient temperature = 25°C 3. Input voltage is 230Vac	CBM100S120		90		%
		CBM100S240		91		
		CBM100S280		91		
		CBM100S360		91		
		CBM100S480		91.5		
ISOLATION CHARACTERISTICS						
Input to Output	1 minute				4242	Vdc
Input to Earth(Ground)	1 minute				2121	Vdc
Output to Earth(Ground)	1 minute				500	Vdc
Isolation Resistance			100			MΩ
GENERAL SPECIFICATIONS						
MTBF	Vin = 115Vac, Io = 100%, Ta=25°C per MIL-HDBK-217F		100			K Hours
Switching Frequency				130		KHz
Weight				236		g



CBM100S Series

Application Note

4. Main Features and Functions

4.1 Operating Temperature Range

The highly efficient design of Cincon's CBM100S series power module has resulted in their ability to operate within ambient temperature environments from -20°C to 85°C. The derating curve was drawn from the CBM100S power module.

4.2 Output Protection

■ Over current protection (OCP)

CBM100S Series provide fully continuous short-circuit protection. The unit will auto recover until the short circuit is removed. To provide a protection in a fault condition, the unit is equipped with internal OCP. The unit will operate normally until the fault condition is removed. The power module will go to hiccup mode if output current reaches the condition of OCP, 130% to 200% rated current.

■ Over voltage protection (OVP)

All different voltage models have a fully continuous OVP. The power module will supply OVP, and the maximum voltage of OVP is 140% rated voltage. In the event of happen the OVP, the converter will shut down, and then It must recycle AC input to restart the converter.

5. EMC & Safety

- CB IEC 60950-1
- TUV EN 60950-1
- UL/cUL UL60950-1
- CE EN 55022 Class B,
- FCC Part 15 for a Class B, CISPR 22

6. Applications

6.1 CBM100S Series Derating Curve

The operating temperature range of CBM100S series is -25°C to +85°C. When operating the CBM100S series, proper derating is needed. The maximum ambient temperature under any operating condition should not exceed 85°C.

The following chart is the derating curve of CBM100S series.

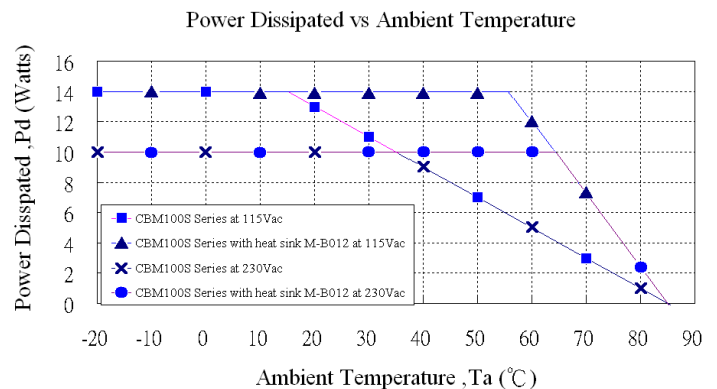

Example :

What is the maximum ambient temperature of CBM100S120 operating at Vin=115Vac and 50% rated load with heat sink M-B012?

	Typical Thermal Resistance (Rca)
Heat Sink M-B012 Natural Convection 20ft./min.(0.1m/s)	2.07°C/W
No Heat Sink Natural Convection 20ft./min.(0.1m/s)	5.0°C/W

Solution:

Given:

- Heat sink M-B012 thermal resistance 2.07°C/W
- Vin=115Vac, Vo=12Vdc
- When Io=4.2A, efficiency=88.6% (see chapter 6.5)

Determine Power dissipation (Pd):

$$Pd = P_i - P_o = P_o(1 - \eta) / \eta$$

$$= 12 \times 4.2 \times (1 - 0.886) / 0.886 = 6.4 \text{ Watts}$$

Determine maximum ambient temperature:

- Given: Pd=6.4W
- Then check above Power derating curve
- The maximum ambient temperature is about Ta=71°C

Verify:

$$\text{Maximum temperature rise } \Delta T = Pd \times Rca = 6.4 \times 2.07 = 13.248^\circ\text{C}$$

$$\text{Maximum ambient temperature } Ta = Tc - \Delta T = 85 - 13.248 = 71.752^\circ\text{C}$$

Where:

- The Rca is thermal resistance from case to ambience.
- The Ta is ambient temperature and the Tc is case temperature.



CBM100S Series

Application Note

6.2 Full-Brick Heat Sink

Longitudinal Fins

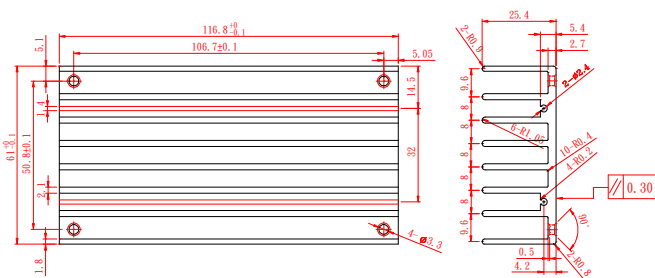

Heat Sink: 116.8*61*25.4(mm)(M-B012-00A) (G6620090204)
 Thermal pad: SR60*115.8*0.23 (G6135013070)
 Screw SMP+SW M3*8L (G75A1300322)
 Rca: 2.07°C/W (typ.), at natural convection

6.3 Test Set-Up

The basic test set-up to measure parameters such as efficiency and load regulation is shown in Figure 1. When testing the Cincon's CBM100S series under any transient conditions, please ensure that the transient response of the source is sufficient to power the equipment under test. We can calculate the

- Efficiency
- Load regulation and line regulation.

The value of efficiency is defined as:

$$\eta = \frac{V_o \times I_o}{P_{in}} \times 100\%$$

Where:

- Vo is output voltage,
- Io is output current,
- Pin is input power,

The value of load regulation is defined as:

$$Load_{reg.} = \frac{V_{Full-Load} - V_{60\% Full-Load}}{V_{60\% Full-Load}} \times 100\%$$

$$Load_{reg.} = \frac{V_{60\% Full-Load} - V_{20\% Full-Load}}{V_{20\% Full-Load}} \times 100\%$$

The value of line regulation is defined as:

$$Line_{reg.} = \frac{V_{HL} - V_{LL}}{V_{LL}} \times 100\%$$

Where :

- V_{HL} is the output voltage of maximum input voltage at full load.
- V_{LL} is the output voltage of minimum input voltage at full load.

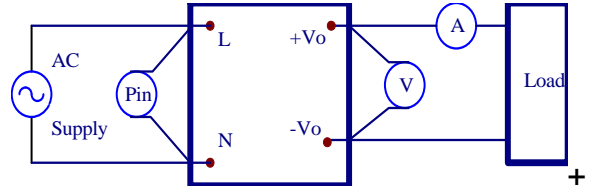

Figure 1. CBM100S Series Test Setup

6.4 Output Ripple and Noise Measurement

The test which set-up for noise and ripple measurement is shown in Figure 2.

Add a 0.1 uF ceramic capacitor and a 47 uF electrolytic capacitor to output at 20 MHz Band Width.

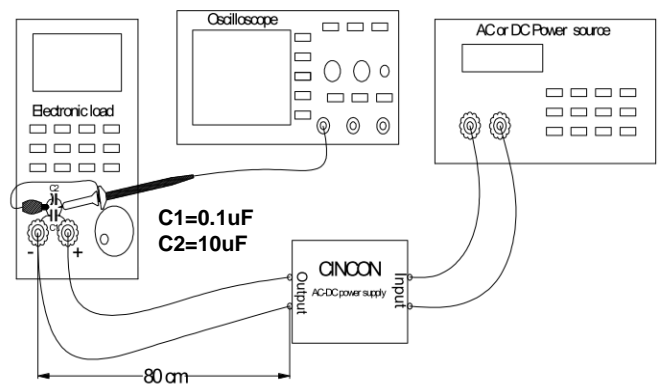

Figure 2. Output Voltage Ripple and Noise Measurement



CBM100S Series

Application Note

6.5 Efficiency VS. Load

CBM100S120
Efficiency VS . Load

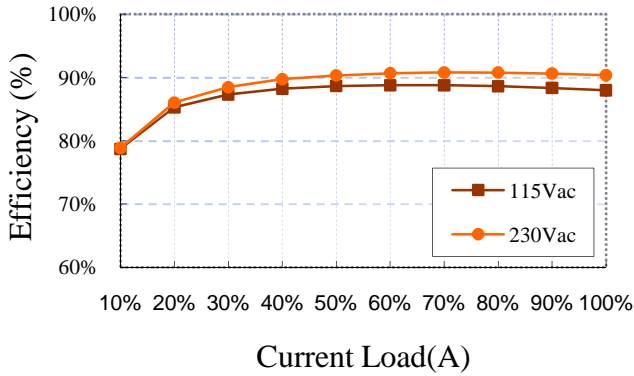

CBM100S240
Efficiency VS . Load

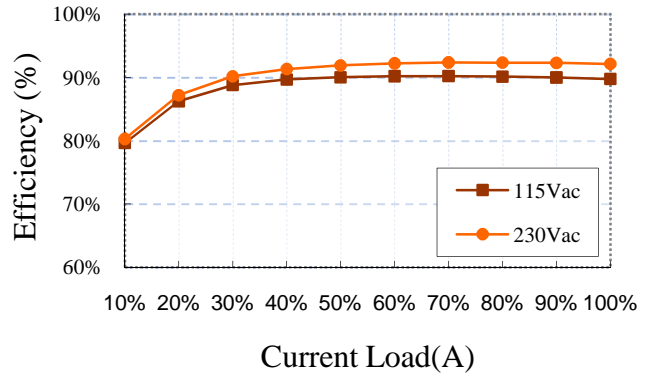

CBM100S280
Efficiency VS . Load

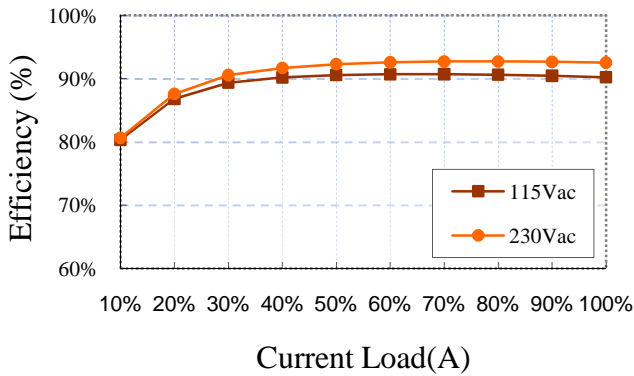

CBM100S360
Efficiency VS . Load

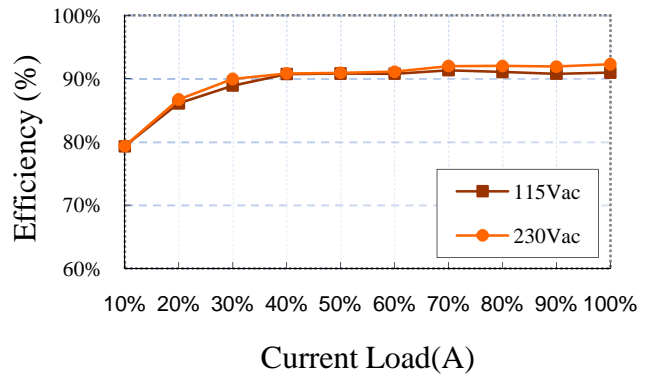

CBM100S480
Efficiency VS . Load

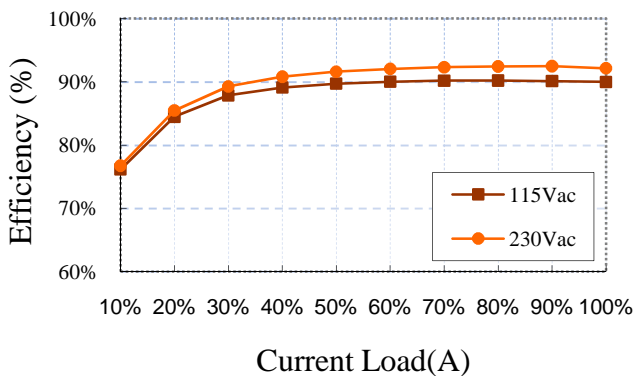



CBM100S Series Application Note

7. CBM100S Series Mechanical Outline Diagrams

Annotations :

All Dimensions in Inches[mm]

Tolerance : Inches : x.xx ±0.02, x.xxx±0.01

Millimeters:x.x=±0.5, x.xx=±0.25

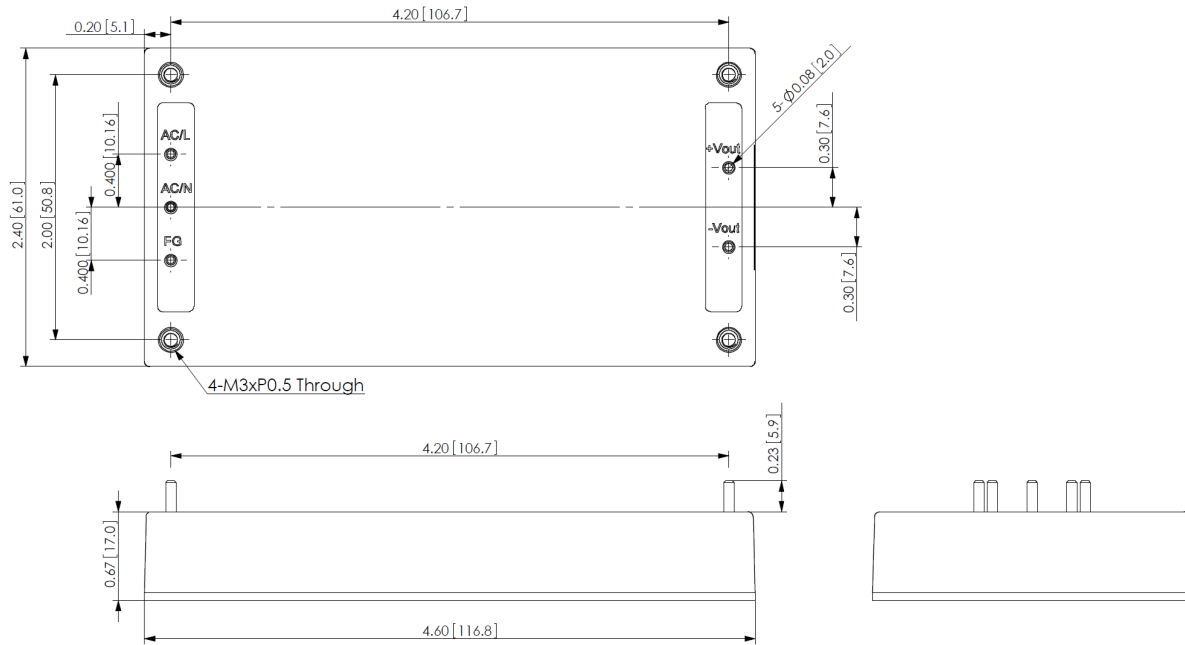

CBM100S series Mechanical Outline Diagram



CBM100S Series

Application Note

8. Part Number

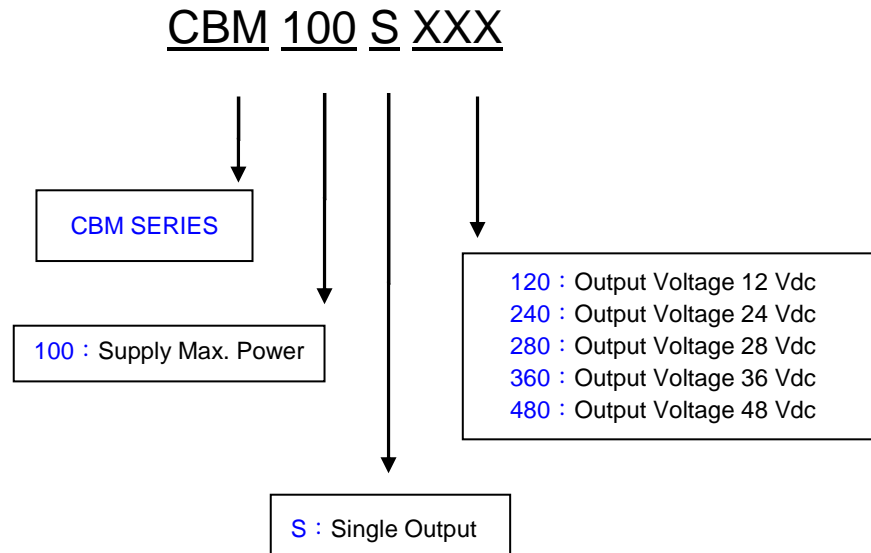

CINCON ELECTRONICS CO., LTD.

Headquarters:

14F, No.306, Sec.4, Hsin Yi Rd.
Taipei, Taiwan
Tel: 886-2-27086210
Fax: 886-2-27029852
E-mail: support@cincon.com.tw
Web Site: <http://www.cincon.com>

Factory:

No. 8-1, Fu Kung Rd.
Fu Hsing Industrial Park
Fu Hsing Hsiang,
Chang Hua Hsien, Taiwan
Tel: 886-4-7690261
Fax: 886-4-7698031

Cincon North America:

1655 Mesa Verde Ave. Ste 180
Ventura, CA 93003
Tel: 805-639-3350
Fax: 805-639-4101
E-mail: info@cincon.com

Компания «Life Electronics» занимается поставками электронных компонентов импортного и отечественного производства от производителей и со складов крупных дистрибьюторов Европы, Америки и Азии.

С конца 2013 года компания активно расширяет линейку поставок компонентов по направлению коаксиальный кабель, кварцевые генераторы и конденсаторы (керамические, пленочные, электролитические), за счёт заключения дистрибьюторских договоров

Мы предлагаем:

- Конкурентоспособные цены и скидки постоянным клиентам.
- Специальные условия для постоянных клиентов.
- Подбор аналогов.
- Поставку компонентов в любых объемах, удовлетворяющих вашим потребностям.
- Приемлемые сроки поставки, возможна ускоренная поставка.
- Доставку товара в любую точку России и стран СНГ.
- Комплексную поставку.
- Работу по проектам и поставку образцов.
- Формирование склада под заказчика.
- Сертификаты соответствия на поставляемую продукцию (по желанию клиента).
- Тестирование поставляемой продукции.
- Поставку компонентов, требующих военную и космическую приемку.
- Входной контроль качества.
- Наличие сертификата ISO.

В составе нашей компании организован Конструкторский отдел, призванный помогать разработчикам, и инженерам.

Конструкторский отдел помогает осуществить:

- Регистрацию проекта у производителя компонентов.
- Техническую поддержку проекта.
- Защиту от снятия компонента с производства.
- Оценку стоимости проекта по компонентам.
- Изготовление тестовой платы монтаж и пусконаладочные работы.



Тел: +7 (812) 336 43 04 (многоканальный)

Email: org@lifeelectronics.ru