

## FEATURES

- 6 independent analog-to-digital converters (ADCs)**
- True bipolar analog inputs**
- Pin-/software-selectable ranges:  $\pm 10\text{ V}$  or  $\pm 5\text{ V}$**
- Fast throughput rate: 250 kSPS**
- iCMOS<sup>®</sup> process technology**
- Low power: 140 mW at 250 kSPS with 5 V supplies**
- Wide input bandwidth**
  - 86.5 dB SNR at 50 kHz input frequency**
- On-chip reference and reference buffers**
- Parallel, serial, and daisy-chain interface modes**
- High speed serial interface**
  - Serial peripheral interface (SPI)/QSPI<sup>™</sup>/MICROWIRE<sup>®</sup>/DSP compatible**
- Power-down mode: 100 mW maximum**
- 64-lead LQFP**
- Improved power supply sequencing (PSS) robustness**

## APPLICATIONS

- Power line monitoring systems**
- Instrumentation and control systems**
- Multi-axis positioning systems**

## GENERAL DESCRIPTION

The [AD7656A](#)<sup>1</sup> contains six 16-bit, fast, low power, successive approximation analog-to-digital converters (ADCs) all in the one package that is designed on the iCMOS<sup>®</sup> process (industrial CMOS). iCMOS is a process combining high voltage silicon with submicron CMOS and complementary bipolar technologies. It enables the development of a wide range of high performance analog ICs, capable of 33 V operation in a footprint that no previous generation of high voltage devices could achieve. Unlike analog ICs using conventional CMOS processes, iCMOS components can accept bipolar input signals while providing increased performance, which dramatically reduces power consumption and package size.

The [AD7656A](#) features throughput rates of up to 250 kSPS. It contains wide bandwidth (12 MHz), track-and-hold amplifiers that can handle input frequencies up to 12 MHz.

<sup>1</sup> Protected by U.S. Patent No. 6,731,232.

Rev. 0

[Document Feedback](#)

Information furnished by Analog Devices is believed to be accurate and reliable. However, no responsibility is assumed by Analog Devices for its use, nor for any infringements of patents or other rights of third parties that may result from its use. Specifications subject to change without notice. No license is granted by implication or otherwise under any patent or patent rights of Analog Devices. Trademarks and registered trademarks are the property of their respective owners.

## FUNCTIONAL BLOCK DIAGRAM

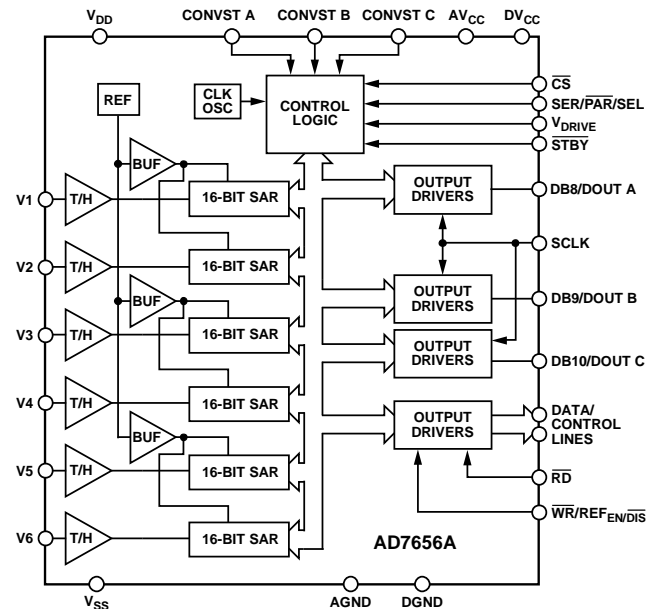

Figure 1.

The conversion process and data acquisition are controlled using CONVST x signals and an internal oscillator. Three CONVST x pins (CONVST A, CONVST B, and CONVST C) allow independent, simultaneous sampling of the three ADC pairs. The [AD7656A](#) has a high speed parallel and serial interface, allowing the device to interface with microprocessors or digital signal processors (DSPs). In serial interface mode, the [AD7656A](#) has a daisy-chain feature that allows multiple ADCs to connect to a single serial interface. The [AD7656A](#) can accommodate true bipolar input signals in the  $\pm 4 \times V_{REF}$  range and  $\pm 2 \times V_{REF}$  range. The [AD7656A](#) also contains an on-chip 2.5 V reference. Multifunction pin names may be referenced by their relevant function only.

## PRODUCT HIGHLIGHTS

1. Six 16-bit, 250 kSPS ADCs on board.
2. Six true bipolar, high impedance analog inputs.
3. Parallel and high speed serial interfaces.

## TABLE OF CONTENTS

Features .....	1	Theory of Operation .....	15
Applications.....	1	Converter Details .....	15
Functional Block Diagram .....	1	ADC Transfer Function.....	16
General Description .....	1	Reference Section .....	16
Product Highlights .....	1	Typical Connection Diagram .....	16
Revision History .....	2	Driving the Analog Inputs .....	17
Specifications.....	3	Interface Section.....	17
Timing Specifications .....	5	Software Selection of ADCs.....	19
Absolute Maximum Ratings.....	6	Serial Read Operation.....	21
Power Supply Sequencing .....	6	Daisy-Chain Mode (DCEN = 1, SER/ $\overline{\text{PAR}}$ /SEL = 1) .....	21
Thermal Resistance .....	6	Application Hints .....	24
ESD Caution.....	6	Layout .....	24
Pin Configuration and Function Descriptions.....	7	Outline Dimensions .....	25
Typical Performance Characteristics .....	10	Ordering Guide .....	25
Terminology .....	13		

## REVISION HISTORY

12/13—Revision 0: Initial Version

## SPECIFICATIONS

$V_{REF} = 2.5$  V internal/external,  $AV_{CC} = 4.75$  V to 5.25 V,  $DV_{CC} = 4.75$  V to 5.25 V, and  $V_{DRIVE} = 2.7$  V to 5.25 V. For the  $\pm 4 \times V_{REF}$  range,  $V_{DD} = 11$  V to 16.5 V, and  $V_{SS} = -11$  V to  $-16.5$  V. For the  $\pm 2 \times V_{REF}$  range,  $V_{DD} = 6$  V to 16.5 V, and  $V_{SS} = -6$  V to  $-16.5$  V.  $f_{SAMPLE} = 250$  kSPS, and  $T_A = T_{MIN}$  to  $T_{MAX}$ , unless otherwise noted.

Table 1.

Parameter	Min	Typ	Max	Unit	Test Conditions/Comments
<b>DYNAMIC PERFORMANCE</b>					
Signal-to-Noise + Distortion (SINAD) <sup>1</sup>	84	85.5		dB	$f_{IN} = 50$ kHz sine wave
Signal-to-Noise Ratio (SNR) <sup>1</sup>	85	86.5		dB	
Total Harmonic Distortion (THD) <sup>1</sup>			-90	dB	
RANGE Pin = 0		-92		dB	$V_{DD}/V_{SS} = \pm 6$ V to $\pm 11$ V
RANGE Pin = 1		-100		dB	$V_{DD}/V_{SS} = \pm 12$ V to $\pm 16.5$ V
Peak Harmonic or Spurious Noise (SFDR) <sup>1</sup>		-100		dB	
Intermodulation Distortion (IMD) <sup>1</sup>					$f_a = 50$ kHz, $f_b = 49$ kHz
Second-Order Terms		-112		dB	
Third-Order Terms		-107		dB	
Aperture Delay			10	ns	
Aperture Delay Matching			4	ns	
Aperture Jitter		35		ps	
Channel-to-Channel Isolation <sup>1</sup>		-100		dB	$f_{IN}$ on unselected channels up to 100 kHz
Full Power Bandwidth		12		MHz	At -3 dB
		2		MHz	At -0.1 dB
<b>DC ACCURACY</b>					
Resolution		16		Bits	
No Missing Codes	15			Bits	
	16			Bits	At 25°C
Integral Nonlinearity <sup>1</sup>			$\pm 3$	LSB	
		$\pm 1$		LSB	
Positive Full-Scale Error <sup>1</sup>		$\pm 0.22\%$	$\pm 0.75$	% FSR	
Positive Full-Scale Error Matching <sup>1</sup>			$\pm 0.35$	% FSR	
Bipolar Zero-Scale Error <sup>1</sup>		$\pm 0.004\%$	$\pm 0.023$	% FSR	
Bipolar Zero-Scale Error Matching <sup>1</sup>			$\pm 0.038$	% FSR	
Negative Full-Scale Error <sup>1</sup>		$\pm 0.22\%$	$\pm 0.75$	% FSR	
Negative Full-Scale Error Matching <sup>1</sup>			$\pm 0.35$	% FSR	
<b>ANALOG INPUT</b>					
Input Voltage Ranges	$-4 \times V_{REF}$		$+4 \times V_{REF}$	V	See Table 6 for the minimum $V_{DD}/V_{SS}$ for each range
	$-2 \times V_{REF}$		$+2 \times V_{REF}$	V	RANGE pin = 0
DC Leakage Current			$\pm 1$	$\mu$ A	RANGE pin = 1
Input Capacitance <sup>2</sup>		10		pF	$\pm 4 \times V_{REF}$ range when in track mode
		14		pF	$\pm 2 \times V_{REF}$ range when in track mode
<b>REFERENCE INPUT/OUTPUT</b>					
Reference Input Voltage Range	2.5		3	V	
DC Leakage Current			$\pm 1$	$\mu$ A	
Input Capacitance <sup>2</sup>		18.5		pF	$REF_{EN}/\overline{DIS} = 1^3$
Reference Output Voltage	2.49		2.51	V	
Long-Term Stability		150		ppm	1000 hours
Reference Temperature Coefficient			25	ppm/°C	
		6		ppm/°C	

Parameter	Min	Typ	Max	Unit	Test Conditions/Comments
<b>LOGIC INPUTS</b>					
Input High Voltage ( $V_{INH}$ )	$0.7 \times V_{DRIVE}$			V	Typically 10 nA, $V_{IN} = 0\text{ V}$ or $V_{DRIVE}$
Input Low Voltage ( $V_{INL}$ )			$0.3 \times V_{DRIVE}$	V	
Input Current ( $I_{IN}$ )			$\pm 1$	$\mu\text{A}$	
Input Capacitance ( $C_{IN}$ ) <sup>2</sup>			10	pF	
<b>LOGIC OUTPUTS</b>					
Output High Voltage ( $V_{OH}$ )	$V_{DRIVE} - 0.2$			V	$I_{SOURCE} = 200\ \mu\text{A}$
Output Low Voltage ( $V_{OL}$ )			0.2	V	$I_{SINK} = 200\ \mu\text{A}$
Floating State Leakage Current			$\pm 1$	$\mu\text{A}$	
Floating State Output Capacitance <sup>2</sup>			10	pF	
Output Coding					
<b>CONVERSION RATE</b>					
Conversion Time			3.1	$\mu\text{s}$	Parallel interface mode only
Track-and-Hold Acquisition Time <sup>1,2</sup>			550	ns	
Throughput Rate			250	kSPS	
<b>POWER REQUIREMENTS</b>					
$V_{DD}$ Range	6		16.5	V	For the $4 \times V_{REF}$ range, $V_{DD} = 11\text{ V}$ to $16.5\text{ V}$
$V_{SS}$ Range	-6		-16.5	V	For the $4 \times V_{REF}$ range, $V_{SS} = -11\text{ V}$ to $-16.5\text{ V}$
$AV_{CC}$	4.75		5.25	V	
$DV_{CC}$	4.75		5.25	V	
$V_{DRIVE}$	2.7		5.25	V	
$I_{TOTAL}$ <sup>4</sup>					Digital inputs = 0 V or $V_{DRIVE}$
Normal Mode (Static)			28	mA	$AV_{CC} = DV_{CC} = V_{DRIVE} = 5.25\text{ V}$ , $V_{DD} = 16.5\text{ V}$ , $V_{SS} = -16.5\text{ V}$
Normal Mode (Operational)			26	mA	$f_{SAMPLE} = 250\text{ kSPS}$ , $AV_{CC} = DV_{CC} = V_{DRIVE} = 5.25\text{ V}$ , $V_{DD} = 16.5\text{ V}$ , $V_{SS} = -16.5\text{ V}$
$I_{SS}$ (Operational)			0.25	mA	$V_{SS} = -16.5\text{ V}$ , $f_{SAMPLE} = 250\text{ kSPS}$
$I_{DD}$ (Operational)			0.25	mA	$V_{DD} = 16.5\text{ V}$ , $f_{SAMPLE} = 250\text{ kSPS}$
Partial Power-Down Mode			7	mA	$AV_{CC} = DV_{CC} = V_{DRIVE} = 5.25\text{ V}$ , $V_{DD} = 16.5\text{ V}$ , $V_{SS} = -16.5\text{ V}$
Full Power-Down Mode ( $\overline{\text{STBY}}$ Pin)			80	mA	SCLK on or off, $AV_{CC} = DV_{CC} = V_{DRIVE} = 5.25\text{ V}$ , $V_{DD} = 16.5\text{ V}$ , $V_{SS} = -16.5\text{ V}$
<b>Power Dissipation</b>					
Normal Mode (Static)			143	mW	
Normal Mode (Operational)			140	mW	$f_{SAMPLE} = 250\text{ kSPS}$
Partial Power-Down Mode			35	mW	
Full Power-Down Mode ( $\overline{\text{STBY}}$ Pin)			100	mW	

<sup>1</sup> See the Terminology section.

<sup>2</sup> Sample tested during initial release to ensure compliance.

<sup>3</sup> Multifunction pin names may be referenced by their relevant function only.

<sup>4</sup> Includes  $I_{AVCC}$ ,  $I_{VDD}$ ,  $I_{VSS}$ ,  $I_{VDRIVE}$ , and  $I_{DVCC}$ .

## TIMING SPECIFICATIONS

$AV_{CC}$  and  $DV_{CC}$  = 4.75 V to 5.25 V,  $V_{DRIVE}$  = 2.7 V to 5.25 V,  $V_{REF}$  = 2.5 V internal/external,  $T_A$  =  $T_{MIN}$  to  $T_{MAX}$ , unless otherwise noted. For the  $\pm 4 \times V_{REF}$  range,  $V_{DD}$  = 11 V to 16.5 V, and  $V_{SS}$  = -11 V to -16.5 V, and for the  $\pm 2 \times V_{REF}$  range,  $V_{DD}$  = 6 V to 16.5 V, and  $V_{SS}$  = -6 V to -16.5 V. Sample tested during initial release to ensure compliance. All input signals are specified with  $t_R = t_F = 5$  ns (10% to 90% of  $V_{DD}$ ) and timed from a voltage level of 1.6 V.

Table 2.

Parameter	Limit at $T_{MIN}, T_{MAX}$		Unit	Description <sup>1</sup>
	$V_{DRIVE} < 4.75$ V	$V_{DRIVE} = 4.75$ V to 5.25 V		
PARALLEL INTERFACE MODE				
$t_{CONVERT}$	3	3	$\mu$ s typ	Conversion time, internal clock
$t_{QUIET}$	150	150	ns min	Minimum quiet time required between bus relinquish and start of next conversion
$t_{ACQ}$	550	550	ns min	Acquisition time
$t_1$	60	60	ns min	CONVST x high to BUSY high
$t_{10}$	25	25	ns min	Minimum CONVST x low pulse
$t_{WAKE-UP}$	2	2	ms max	$\overline{STBY}$ rising edge to CONVST x rising edge, not shown in figures
	25	25	$\mu$ s max	Partial power-down mode
PARALLEL WRITE OPERATION				
$t_{11}$	15	15	ns min	$\overline{WR}$ pulse width
$t_{12}$	0	0	ns min	$\overline{CS}$ to $\overline{WR}$ setup time
$t_{13}$	5	5	ns min	$\overline{CS}$ to $\overline{WR}$ hold time
$t_{14}$	5	5	ns min	Data setup time before $\overline{WR}$ rising edge
$t_{15}$	5	5	ns min	Data hold after $\overline{WR}$ rising edge
PARALLEL READ OPERATION				
$t_2$	0	0	ns min	BUSY to $\overline{RD}$ delay
$t_3$	0	0	ns min	$\overline{CS}$ to $\overline{RD}$ setup time
$t_4$	0	0	ns min	$\overline{CS}$ to $\overline{RD}$ hold time
$t_5$	45	36	ns min	$\overline{RD}$ pulse width
$t_6$	45	36	ns max	Data access time after $\overline{RD}$ falling edge
$t_7$	10	10	ns min	Data hold time after $\overline{RD}$ rising edge
$t_8$	12	12	ns max	Bus relinquish time after $\overline{RD}$ rising edge
$t_9$	6	6	ns min	Minimum time between reads
SERIAL INTERFACE MODE				
$f_{SCLK}$	18	18	MHz max	Frequency of serial read clock
$t_{16}$	12	12	ns max	Delay from $\overline{CS}$ until SDATA three-state disabled
$t_{17}^2$	22	22	ns max	Data access time after SCLK rising edge/ $\overline{CS}$ falling edge
$t_{18}$	$0.4 \times t_{SCLK}$	$0.4 \times t_{SCLK}$	ns min	SCLK low pulse width
$t_{19}$	$0.4 \times t_{SCLK}$	$0.4 \times t_{SCLK}$	ns min	SCLK high pulse width
$t_{20}$	10	10	ns min	SCLK to data valid hold time after SCLK falling edge
$t_{21}$	18	18	ns max	$\overline{CS}$ rising edge to SDATA high impedance

<sup>1</sup> Multifunction pin names may be referenced by their relevant function only.

<sup>2</sup> A buffer is used on the data output pins for this measurement.

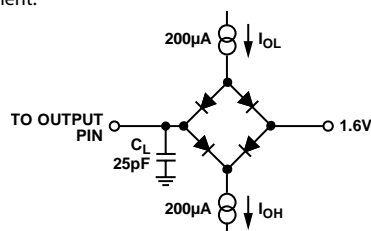

Figure 2. Load Circuit for Digital Output Timing Specifications

## ABSOLUTE MAXIMUM RATINGS

$T_A = 25^\circ\text{C}$ , unless otherwise noted.

Table 3.

Parameter	Rating
$V_{DD}$ to AGND, DGND	0 V to +16.5 V
$V_{SS}$ to AGND, DGND	0 V to -16.5 V
$V_{DD}$ to $AV_{CC}$	$AV_{CC} + 0.7$ V to 16.5 V
$AV_{CC}$ to AGND, DGND	-0.3 V to +7 V
$DV_{CC}$ to $AV_{CC}$	-0.3 V to $AV_{CC} + 0.3$ V
$DV_{CC}$ to DGND, AGND	-0.3 V to +7 V
AGND to DGND	-0.3 V to +0.3 V
$V_{DRIVE}$ to DGND	-0.3 V to $DV_{CC} + 0.3$ V
Analog Input Voltage to AGND	$V_{SS} + 1$ V to $V_{DD} - 1$ V
Digital Input Voltage to DGND	-0.3 V to $V_{DRIVE} + 0.3$ V
Digital Output Voltage to DGND	-0.3 V to $V_{DRIVE} + 0.3$ V
REFIN/REFOUT to AGND	-0.3 V to $AV_{CC} + 0.3$ V
Input Current to Any Pin Except Supplies <sup>1</sup>	$\pm 10$ mA
Operating Temperature Range	-40°C to +85°C
Storage Temperature Range	-65°C to +150°C
Junction Temperature	150°C
Pb/Sn Temperature, Soldering	
Reflow (10 sec to 30 sec)	240(0)°C
Pb-Free Temperature, Soldering Reflow	260(0)°C

<sup>1</sup> Transient currents of up to 100 mA do not cause SCR latch-up.

Stresses above those listed under Absolute Maximum Ratings may cause permanent damage to the device. This is a stress rating only; functional operation of the device at these or any other conditions above those indicated in the operational section of this specification is not implied. Exposure to absolute maximum rating conditions for extended periods may affect device reliability.

## POWER SUPPLY SEQUENCING

Simultaneous application of  $V_{DD}$  and  $V_{SS}$  is necessary to guarantee reliability of the device. In the cases where simultaneous application cannot be guaranteed,  $V_{DD}$  must power up before  $V_{SS}$ . When a negative voltage is applied to the analog inputs before  $V_{DD}$  and  $V_{SS}$  are fully powered up, a 560  $\Omega$  resistor must be placed on the analog inputs.

A number of sequencing combinations can lead to temporary high current states; however, when all supplies are powered up, the device returns to normal operating currents. The analog input ( $A_{IN}$ ) coming before  $AV_{CC}$  causes temporary high current on the analog inputs. Digital inputs before  $DV_{CC}$ , and  $DV_{CC}$  before other supplies, also cause temporary high current states.

## THERMAL RESISTANCE

$\theta_{JA}$  is specified for the worst-case conditions, that is, a device soldered in a circuit board for surface-mount packages. These specifications apply to a 4-layer board.

Table 4. Thermal Resistance

Package Type	$\theta_{JA}$	$\theta_{JC}$	Unit
64-Lead LQFP	45	11	°C/W

## ESD CAUTION



### ESD (electrostatic discharge) sensitive device.

Charged devices and circuit boards can discharge without detection. Although this product features patented or proprietary protection circuitry, damage may occur on devices subjected to high energy ESD. Therefore, proper ESD precautions should be taken to avoid performance degradation or loss of functionality.

# PIN CONFIGURATION AND FUNCTION DESCRIPTIONS

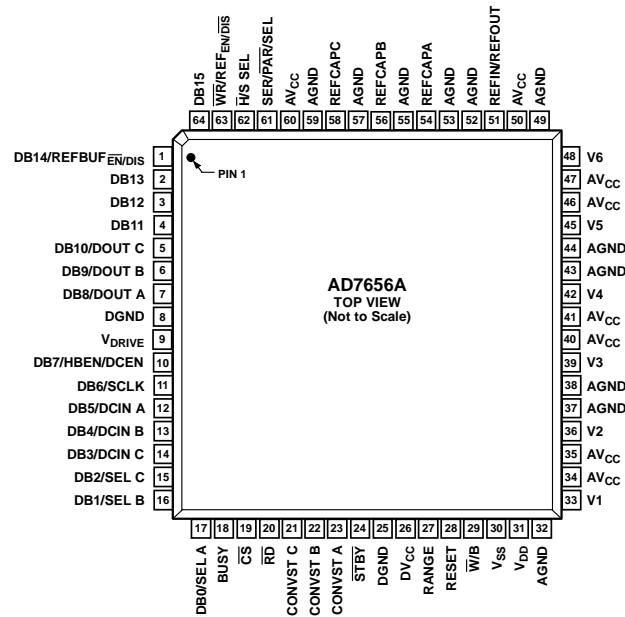

Figure 3. Pin Configuration

Table 5. Pin Function Descriptions<sup>1</sup>

Pin No.	Mnemonic	Description
1	DB14/REFBUF <sup>EN/DIS</sup>	Data Bit 14/Reference Buffer Enable and Disable. When SER/ $\overline{\text{PAR}}/\text{SEL} = 0$ , this pin acts as a three-state digital input/output pin.
2, 3, 64	DB13, DB12, DB15	Data Bit 13, Data Bit 12, and Data Bit 15. When SER/ $\overline{\text{PAR}}/\text{SEL} = 0$ , these pins act as three-state parallel digital input/output pins. When $\overline{\text{CS}}$ and $\overline{\text{RD}}$ are low, these pins are used to output the conversion result. When $\overline{\text{CS}}$ and $\overline{\text{WR}}$ are low, these pins are used to write to the control register. When SER/ $\overline{\text{PAR}}/\text{SEL} = 1$ , tie these pins to DGND.
4	DB11	Data Bit 11/Digital Ground. When SER/ $\overline{\text{PAR}}/\text{SEL} = 0$ , this pin acts as a three-state parallel digital output pin. When SER/ $\overline{\text{PAR}}/\text{SEL} = 1$ , tie this pin to DGND.
5	DB10/DOUT C	Data Bit 10/Serial Data Output C. When SER/ $\overline{\text{PAR}}/\text{SEL} = 0$ , this pin acts as a three-state parallel digital output pin. When SER/ $\overline{\text{PAR}}/\text{SEL} = 1$ and SEL C = 1, this pin takes on its DOUT C function and outputs serial conversion data. this pin configures the serial interface to have three DOUT x output lines.
6	DB9/DOUT B	Data Bit 9/Serial Data Output B. When SER/ $\overline{\text{PAR}}/\text{SEL} = 0$ , Pin 6 acts as a three-state parallel digital output pin. When SER/ $\overline{\text{PAR}}/\text{SEL} = 1$ and SEL B = 1, Pin 6 takes on its DOUT B function and outputs serial conversion data. this pin configures the serial interface to have two DOUT x output lines.
7	DB8/DOUT A	Data Bit 8/Serial Data Output A. When SER/ $\overline{\text{PAR}}/\text{SEL} = 0$ , this pin acts as a three-state parallel digital output pin. When SER/ $\overline{\text{PAR}}/\text{SEL} = 1$ and SEL A = 1, this pin takes on its DOUT A function and outputs serial conversion data.
8, 25	DGND	Digital Ground. These pins are the ground reference point for all digital circuitry on the AD7656A. Connect both DGND pins to the DGND plane of a system. Ideally, the DGND and AGND voltages are at the same potential and must not be more than 0.3 V apart, even on a transient basis.
9	V <sub>DRIVE</sub>	Logic Power Supply Input. The voltage supplied at this pin determines the operating voltage of the interface. Nominally, it is at the same supply as the supply of the host interface. Decouple this pin to DGND, and place 10 $\mu\text{F}$ and 100 nF decoupling capacitors on the V <sub>DRIVE</sub> pin.

Pin No.	Mnemonic	Description
10	DB7/HBEN/DCEN	Data Bit 7/High Byte Enable/Daisy-Chain Enable. When operating in parallel word mode ( $\overline{\text{SER}}/\overline{\text{PAR}}/\text{SEL} = 0$ and $\overline{\text{W}}/\text{B} = 0$ ), Pin 10 takes on its Data Bit 7 function. When operating in parallel byte mode ( $\overline{\text{SER}}/\overline{\text{PAR}}/\text{SEL} = 0$ and $\overline{\text{W}}/\text{B} = 1$ ), Pin 10 takes on its HBEN function. When in this mode and the HBEN pin is logic high, the data is output MSB byte first on DB15 to DB8. When the HBEN pin is logic low, the data is output LSB byte first on DB15 to DB8. When operating in serial mode ( $\overline{\text{SER}}/\overline{\text{PAR}}/\text{SEL} = 1$ ), Pin 10 takes on its DCEN function. When the DCEN pin is logic high, the AD7656A operates in daisy-chain mode with DB5 to DB3 taking on their DCIN A to DCIN C function. When operating in serial mode but not in daisy-chain mode, tie DCEN to DGND.
11	DB6/SCLK	Data Bit 6/Serial Clock. When $\overline{\text{SER}}/\overline{\text{PAR}}/\text{SEL} = 0$ , this pin acts as a three-state parallel digital output pin. When $\overline{\text{SER}}/\overline{\text{PAR}}/\text{SEL} = 1$ , this pin takes on its SCLK input function; it is the read serial clock for the serial transfer.
12	DB5/DCIN A	Data Bit 5/Daisy-Chain Input A. When $\overline{\text{SER}}/\overline{\text{PAR}}/\text{SEL}$ is low, this pin acts as a three-state parallel digital output pin. When $\overline{\text{SER}}/\overline{\text{PAR}}/\text{SEL} = 1$ and $\text{DCEN} = 1$ , this pin acts as Daisy-Chain Input A. When operating in serial mode but not in daisy-chain mode, tie this pin to DGND.
13	DB4/DCIN B	Data Bit 4/Daisy-Chain Input B. When $\overline{\text{SER}}/\overline{\text{PAR}}/\text{SEL} = 0$ , this pin acts as a three-state parallel digital output pin. When $\overline{\text{SER}}/\overline{\text{PAR}}/\text{SEL} = 1$ and $\text{DCEN} = 1$ , this pin acts as Daisy-Chain Input B. When operating in serial mode but not in daisy-chain mode, tie this pin to DGND.
14	DB3/DCIN C	Data Bit 3/Daisy-Chain Input C. When $\overline{\text{SER}}/\overline{\text{PAR}}/\text{SEL} = 0$ , this pin acts as a three-state parallel digital output pin. When $\overline{\text{SER}}/\overline{\text{PAR}}/\text{SEL} = 1$ and $\text{DCEN} = 1$ , this pin acts as Daisy-Chain Input C. When operating in serial mode but not in daisy-chain mode, tie this pin to DGND.
15	DB2/SEL C	Data Bit 2/Select DOUT C. When $\overline{\text{SER}}/\overline{\text{PAR}}/\text{SEL} = 0$ , this pin acts as a three-state parallel digital output pin. When $\overline{\text{SER}}/\overline{\text{PAR}}/\text{SEL} = 1$ , this pin takes on its SEL C function; it is used to configure the serial interface. If this pin is 1, the serial interface operates with three DOUT output pins and enables DOUT C as a serial output. If this pin is 0, the DOUT C is not enabled to operate as a serial data output pin. Leave unused serial DOUT pins unconnected.
16	DB1/SEL B	Data Bit 1/Select DOUT B. When $\overline{\text{SER}}/\overline{\text{PAR}}/\text{SEL} = 0$ , this pin acts as a three-state parallel digital output pin. When $\overline{\text{SER}}/\overline{\text{PAR}}/\text{SEL} = 1$ , this pin takes on its SEL B function; it is used to configure the serial interface. If this pin is 1, the serial interface operates with two or three DOUT x output pins and enables DOUT B as a serial output. If this pin is 0, the DOUT B is not enabled to operate as a serial data output pin and only one DOUT output pin, DOUT A, is used. Leave unused serial DOUT pins unconnected.
17	DB0/SEL A	Data Bit 0/Select DOUT A. When $\overline{\text{SER}}/\overline{\text{PAR}}/\text{SEL} = 0$ , this pin acts as a three-state parallel digital output pin. When $\overline{\text{SER}}/\overline{\text{PAR}}/\text{SEL} = 1$ , Pin 17 takes on its SEL A function; it is used to configure the serial interface. If this pin is 1, the serial interface operates with one, two, or three DOUT x output pins and enables DOUT A as a serial output. When operating in serial mode, this pin must always be 1.
18	BUSY	Busy Output. This pin transitions high when a conversion is started and remains high until the conversion is complete and the conversion data is latched into the output data registers. Do not initiate a new conversion on the AD7656A when the BUSY signal is high.
19	$\overline{\text{CS}}$	Chip Select. This active low logic input frames the data transfer. When both $\overline{\text{CS}}$ and $\overline{\text{RD}}$ are logic low in parallel mode, the output bus is enabled and the conversion result is output on the parallel data bus lines. When both $\overline{\text{CS}}$ and $\overline{\text{WR}}$ are logic low in parallel mode, DB15 to DB8 are used to write data to the on-chip control register. In serial mode, the $\overline{\text{CS}}$ is used to frame the serial read transfer and clock out the MSB of the serial output data.
20	$\overline{\text{RD}}$	Read Data. When both $\overline{\text{CS}}$ and $\overline{\text{RD}}$ are logic low in parallel mode, the output bus is enabled. In serial mode, hold the $\overline{\text{RD}}$ line low.
21, 22, 23	CONVST C, CONVST B, CONVST A	Conversion Start Input C, Conversion Start Input B, and Conversion Start Input A. These logic inputs are used to initiate conversions on the ADC pairs. CONVST A is used to initiate simultaneous conversions on V1 and V2, CONVST B is used to initiate simultaneous conversions on V3 and V4, and CONVST C is used to initiate simultaneous conversions on V5 and V6. When CONVST x switches from low to high, the track-and-hold switch on the selected ADC pair switches from track to hold, and the conversion is initiated. These inputs can also be used to place the ADC pairs into partial power-down mode.
24	$\overline{\text{STBY}}$	Standby Mode Input. This pin is used to put all six on-chip ADCs into standby mode. The $\overline{\text{STBY}}$ pin is high for normal operation and low for standby operation.
26	DV <sub>CC</sub>	Digital Power, 4.75 V to 5.25 V. Ideally, the DV <sub>CC</sub> and AV <sub>CC</sub> voltages are at the same potential and must not be more than 0.3 V apart, even on a transient basis. Decouple this supply to DGND, and place 10 $\mu\text{F}$ and 100 nF decoupling capacitors on the DV <sub>CC</sub> pin.



Pin No.	Mnemonic	Description
27	RANGE	Analog Input Range Selection. Logic input. The logic level on this pin determines the input range of the analog input channels. When this pin is Logic 1 at the falling edge of BUSY, the range for the next conversion is $\pm 2 \times V_{REF}$ . When this pin is Logic 0 at the falling edge of BUSY, the range for the next conversion is $\pm 4 \times V_{REF}$ . In hardware select mode, the RANGE pin is checked on the falling edge of BUSY. In software mode ( $\overline{H/S SEL} = 1$ ), the RANGE pin can be tied to DGND, and the input range is determined by the RNGA, RNGB, and RNGC bits in the control register.
28	RESET	Reset Input. When set to logic high, this pin resets the AD7656A, and the current conversion, if any, is aborted. The internal register is set to all 0s. In hardware mode, the AD7656A is configured depending on the logic levels on the hardware select pins. In all modes, after power-up, the device must receive a RESET pulse. The reset high pulse is typically 100 ns wide. After the RESET pulse, the AD7656A needs to see a valid CONVST pulse to initiate a conversion; this typically consists of a high-to-low CONVST edge followed by a low-to-high CONVST edge. During the RESET pulse, the CONVST x signal must be high.
29	$\overline{W/B}$	Word/Byte Input. When this pin is logic low, data can be transferred to and from the AD7656A using the parallel data lines DB15 to DB0. When this pin is logic high, byte mode is enabled. In this mode, data is transferred using data lines DB15 to DB8 and DB7 takes on its HBEN function. To obtain the 16-bit conversion result, 2-byte reads are required. In serial mode, tie this pin to DGND.
30	V <sub>SS</sub>	Negative Power Supply Voltage. This is the negative supply voltage for the analog input section. Place 10 $\mu$ F and 100 nF decoupling capacitors on the V <sub>SS</sub> pin.
31	V <sub>DD</sub>	Positive Power Supply Voltage. This is the positive supply voltage for the analog input section. Place 10 $\mu$ F and 100 nF decoupling capacitors on the V <sub>DD</sub> pin.
32, 37, 38, 43, 44, 49, 52, 53, 55, 57, 59	AGND	Analog Ground. Ground reference point for all analog circuitry on the AD7656A. Refer all analog input signals and any external reference signal to the AGND voltage. Connect all AGND pins to the AGND plane of a system. Ideally, the AGND and DGND voltages are at the same potential and must not be more than 0.3 V apart, even on a transient basis.
33, 36, 39, 42, 45, 48	V1 to V6	Analog Input 1 to Analog Input 6. These are six single-ended analog inputs. In hardware mode, the analog input range on these channels is determined by the RANGE pin. In software mode, it is determined by Bit RNGC to Bit RNGA of the control register (see Table 9).
34, 35, 40, 41, 46, 47, 50, 60	AV <sub>CC</sub>	Analog Supply Voltage, 4.75 V to 5.25 V. The AV <sub>CC</sub> pin is the supply voltage for the ADC cores. Ideally, the AV <sub>CC</sub> and DV <sub>CC</sub> voltages are at the same potential and must not be more than 0.3 V apart, even on a transient basis. Decouple these supply pins to AGND, and place 10 $\mu$ F and 100 nF decoupling capacitors on the AV <sub>CC</sub> pins.
51	REFIN/REFOUT	Reference Input/Reference Output. The on-chip reference is available on Pin 51 for external use to the AD7656A. Alternatively, the internal reference can be disabled and an external reference can be applied to this input. See the Reference Section. When the internal reference is enabled, decouple Pin 51 using at least a 10 $\mu$ F decoupling capacitor.
54, 56, 58	REFCAPA, REFCAPB, REFCAPC	Reference Capacitor A, Reference Capacitor B, and Reference Capacitor C. Decoupling capacitors are connected to these pins, which decouples the reference buffer for each ADC pair. Decouple each REFCAPx pin to AGND using 10 $\mu$ F and 100 nF capacitors.
61	SER/ $\overline{PAR}$ /SEL	Serial/Parallel Selection Input. When this pin is low, the parallel interface is selected. When this pin is high, the serial interface mode is selected. In serial mode, DB10 to DB8 take on their DOUT C to DOUT A function, DB0 to DB2 take on their DOUT select function, and DB7 takes on its DCEN function. In serial mode, tie DB15 and DB13 to DB11 to DGND.
62	$\overline{H/S SEL}$	Hardware/Software Select Input. Logic input. When $\overline{H/S SEL} = 0$ , the AD7656A operates in hardware select mode, and the ADC pairs to be simultaneously sampled are selected by the CONVST x pins. When $\overline{H/S SEL} = 1$ , the ADC pairs to be sampled simultaneously are selected by writing to the control register. In serial mode, CONVST A is used to initiate conversions on the selected ADC pairs.
63	$\overline{WR}/\overline{REF_{EN/DIS}}$	Write Data/Reference Enable/Disable. When $\overline{H/S SEL}$ pin is high and both $\overline{CS}$ and $\overline{WR}$ are logic low, DB15 to DB8 are used to write data to the internal control register. When the $\overline{H/S SEL}$ pin is low, this pin is used to enable or disable the internal reference. When $\overline{H/S SEL} = 0$ and $\overline{REF_{EN/DIS}} = 0$ , the internal reference is disabled, and an external reference must be applied to the REFIN/REFOUT pin. When $\overline{H/S SEL} = 0$ and $\overline{REF_{EN/DIS}} = 1$ , the internal reference is enabled and the REFIN/REFOUT pin must be decoupled. See the Reference Section.

<sup>1</sup> Multifunction pin names may be referenced by their relevant function only.

TYPICAL PERFORMANCE CHARACTERISTICS

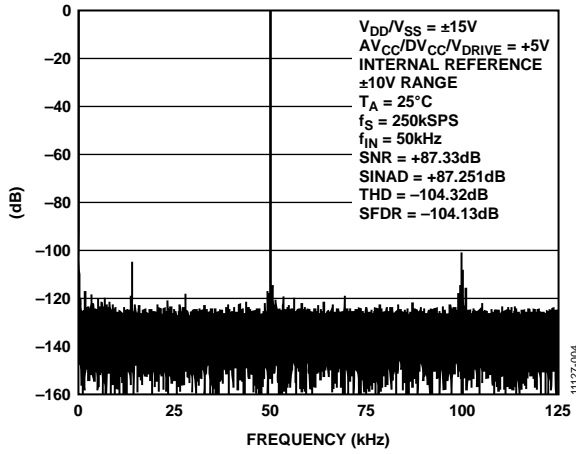

Figure 4. FFT for ±10V Range

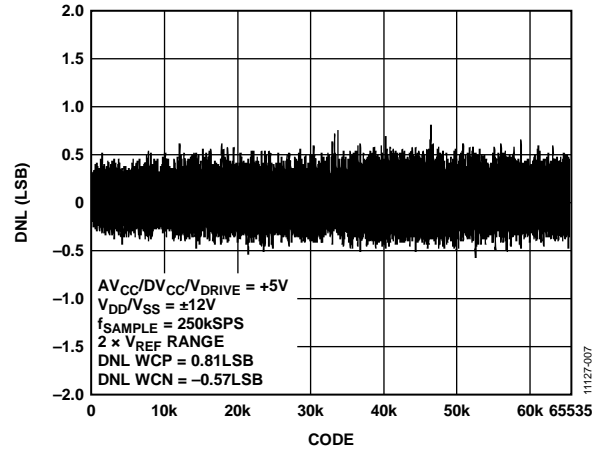

Figure 7. Typical DNL

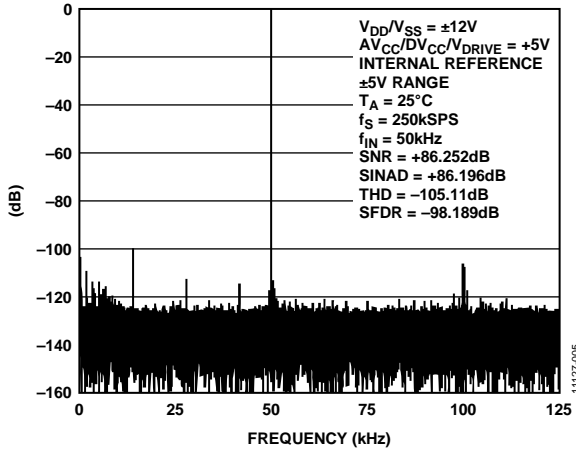

Figure 5. FFT for ±5V Range

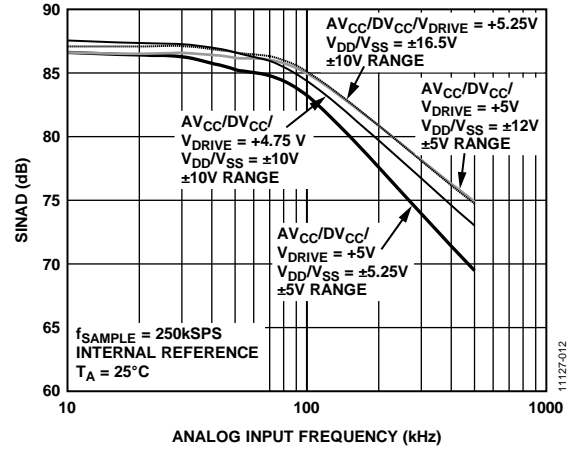

Figure 8. SINAD vs. Analog Input Frequency

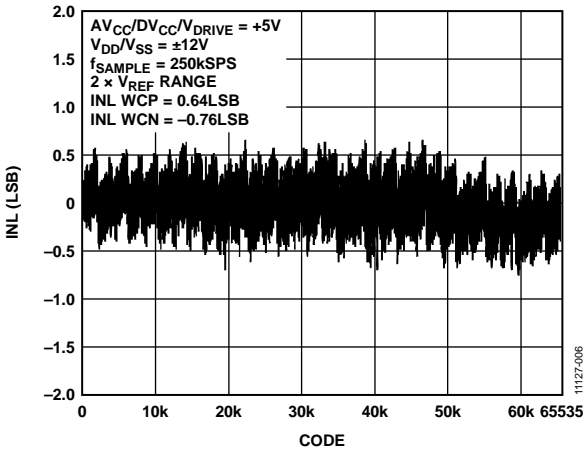

Figure 6. Typical INL

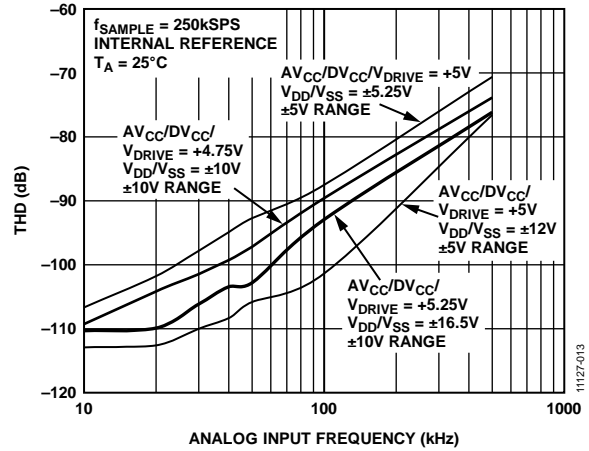

Figure 9. THD vs. Analog Input Frequency

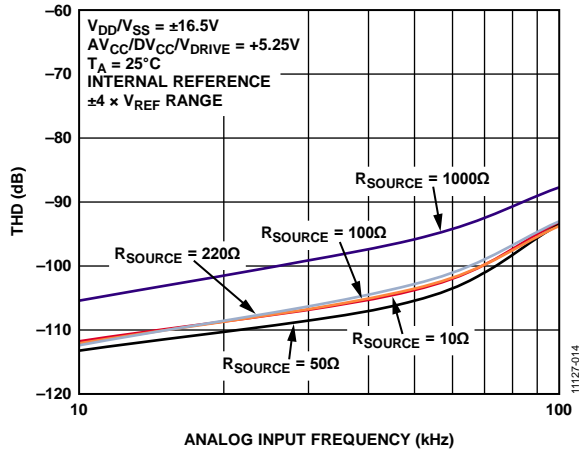

Figure 10. THD vs. Analog Input Frequency for Various Source Impedances,  $\pm 4 \times V_{REF}$  Range

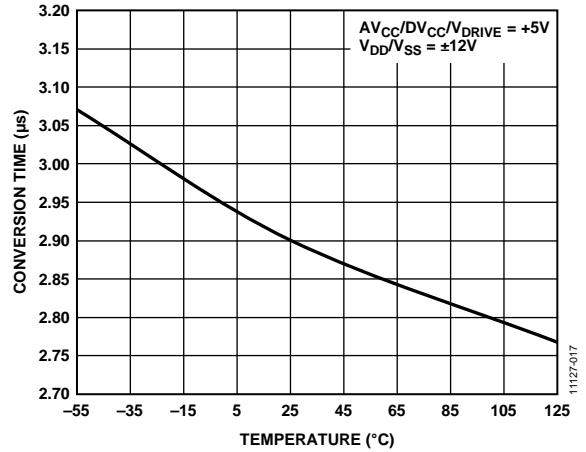

Figure 13. Conversion Time vs. Temperature

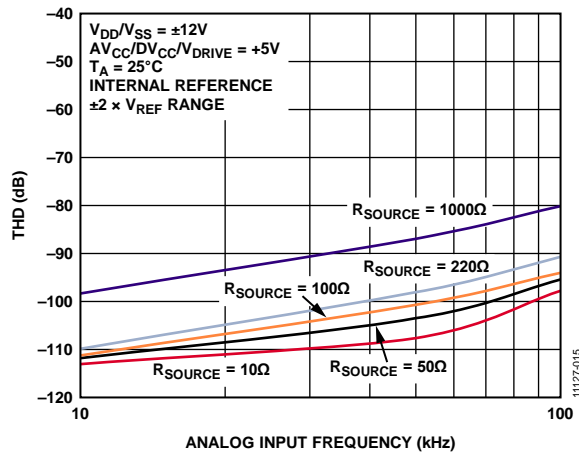

Figure 11. THD vs. Analog Input Frequency for Various Source Impedances,  $\pm 2 \times V_{REF}$  Range

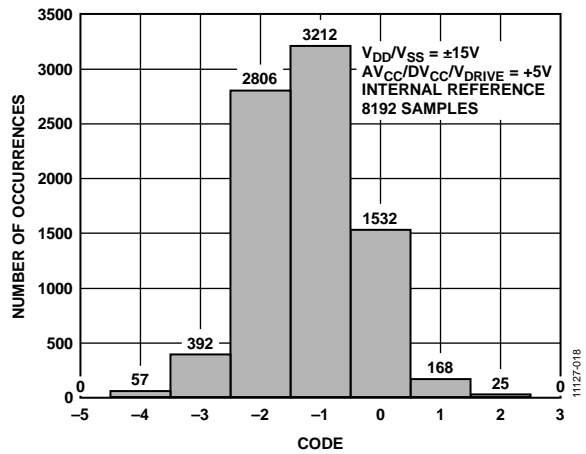

Figure 14. Histogram of Codes

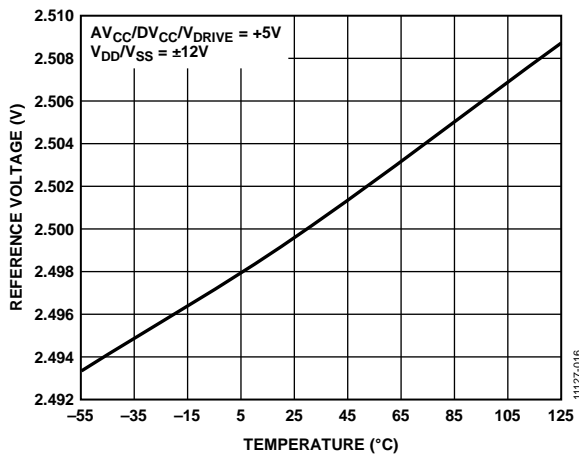

Figure 12. Reference Voltage vs. Temperature

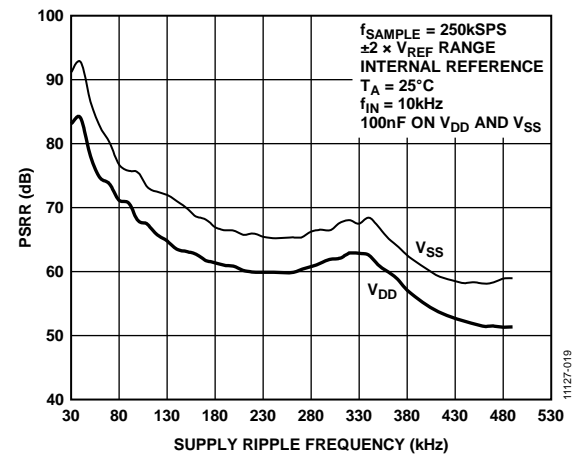

Figure 15. PSRR vs. Supply Ripple Frequency

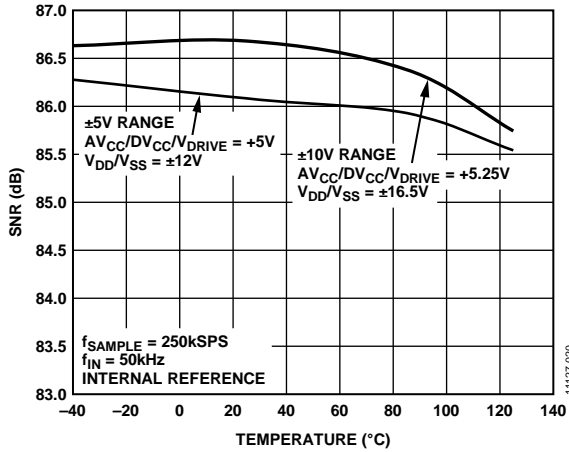

Figure 16. SNR vs. Temperature

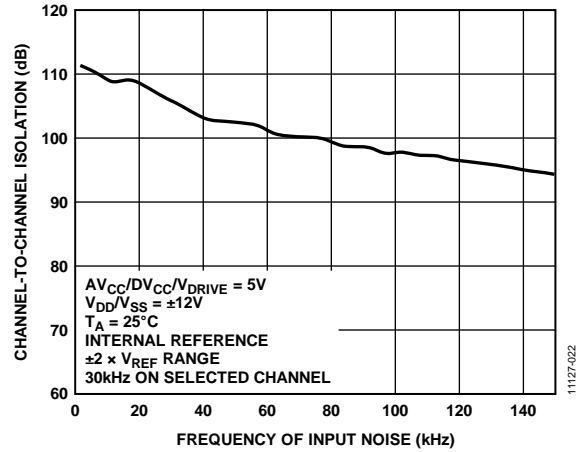

Figure 18. Channel-to-Channel Isolation

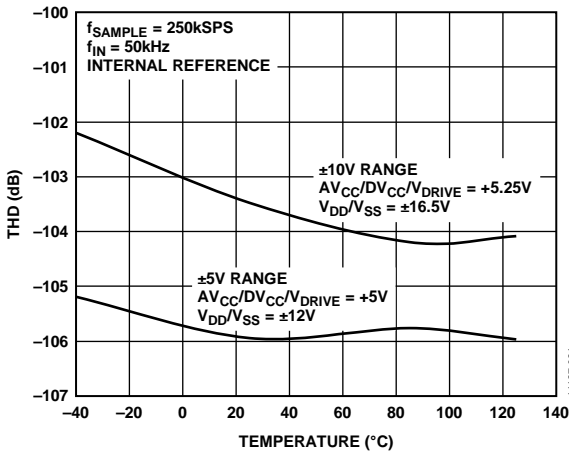

Figure 17. THD vs. Temperature

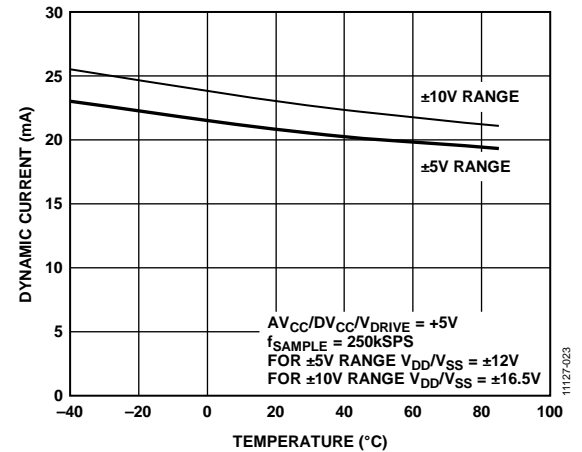

Figure 19. Dynamic Current vs. Temperature

## TERMINOLOGY

### Integral Nonlinearity (INL)

INL is the maximum deviation from a straight line passing through the endpoints of the ADC transfer function. The endpoints of the transfer function are zero scale, a ½ LSB below the first code transition and full scale at ½ LSB above the last code transition.

### Differential Nonlinearity (DNL)

DNL is the difference between the measured and the ideal 1 LSB change between any two adjacent codes in the ADC.

### Bipolar Zero-Scale Error

The bipolar zero-scale error is the deviation of the midscale transition (all 1s to all 0s) from the ideal  $V_{IN}$  voltage, that is,  $AGND - 1 \text{ LSB}$ .

### Bipolar Zero-Scale Error Matching

The bipolar zero-scale error matching is the difference in bipolar zero-code error between any two input channels.

### Positive Full-Scale Error

The positive full-scale error is the deviation of the last code transition (011 ... 110) to (011 ... 111) from the ideal ( $4 \times V_{REF} - 1 \text{ LSB}$  or  $2 \times V_{REF} - 1 \text{ LSB}$ ) after adjusting for the bipolar zero scale error.

### Positive Full-Scale Error Matching

The positive full-scale error matching is the difference in positive full-scale error between any two input channels.

### Negative Full-Scale Error

The negative full-scale error is the deviation of the first code transition (10 ... 000) to (10 ... 001) from the ideal ( $-4 \times V_{REF} + 1 \text{ LSB}$  or  $-2 \times V_{REF} + 1 \text{ LSB}$ ) after adjusting for the bipolar zero-code error.

### Negative Full-Scale Error Matching

The negative full-scale error matching is the difference in negative full-scale error between any two input channels.

### Track-and-Hold Acquisition Time

The track-and-hold amplifier returns to track mode at the end of the conversion. The track-and-hold acquisition time is the time required for the output of the track-and-hold amplifier to reach its final value, within  $\pm 1 \text{ LSB}$ , after the end of the conversion. See the Track-and-Hold Amplifiers section for more details.

### Signal-to-Noise Ratio (SNR)

SNR is the ratio of the rms value of the measured output signal to the rms sum of all other spectral components below the Nyquist frequency. The value for SNR is expressed in decibels.

### Signal-to-Noise-and-Distortion (SINAD) Ratio

The SINAD ratio is the measured ratio of signal-to-noise-and-distortion at the output of the ADC. The signal is the rms amplitude of the fundamental. Noise is the sum of all nonfundamental signals up to half the sampling frequency ( $f_{SAMPLE}/2$ , excluding dc).

The ratio depends on the number of quantization levels in the digitization process: the more levels, the smaller the quantization noise. The theoretical SINAD ratio for an ideal N-bit converter with a sine wave input is given by

$$SINAD = (6.02 N + 1.76) \text{ dB}$$

Therefore, SINAD is 98 dB for a 16-bit converter.

### Total Harmonic Distortion (THD)

THD is the ratio of the rms sum of the harmonics to the fundamental. For the AD7656A, it is defined as

$$THD(\text{dB}) = 20 \log \frac{\sqrt{V_2^2 + V_3^2 + V_4^2 + V_5^2 + V_6^2}}{V_1}$$

where:

$V_1$  is the rms amplitude of the fundamental.

$V_2, V_3, V_4, V_5,$  and  $V_6$  are the rms amplitudes of the second through sixth harmonics.

### Peak Harmonic or Spurious Noise

The peak harmonic or spurious noise is the ratio of the rms value of the next largest component in the ADC output spectrum (up to  $f_{SAMPLE}/2$ , excluding dc) to the rms value of the fundamental. Normally, the value of this specification is determined by the largest harmonic in the spectrum, but for ADCs where the harmonics are buried in the noise floor, it is determined by a noise peak.

### Intermodulation Distortion (IMD)

With inputs consisting of sine waves at two frequencies,  $f_a$  and  $f_b$ , any active device with nonlinearities create distortion products at sum and difference frequencies of  $m f_a \pm n f_b$ , where  $m, n = 0, 1, 2, 3$ . Intermodulation distortion terms are those for which neither  $m$  nor  $n$  are equal to 0. For example, the second-order terms include  $(f_a + f_b)$  and  $(f_a - f_b)$ , and the third-order terms include  $(2f_a + f_b)$ ,  $(2f_a - f_b)$ ,  $(f_a + 2f_b)$ , and  $(f_a - 2f_b)$ .

The AD7656A is tested using the CCIF standard in which two input frequencies near the maximum input bandwidth are used. In this case, the second-order terms are usually distanced in frequency from the original sine waves, and the third-order terms are usually at a frequency close to the input frequencies. As a result, the second- and third-order terms are specified separately. The calculation of the intermodulation distortion is per the THD specification, where it is the ratio of the rms sum of the individual distortion products to the rms amplitude of the sum of the fundamentals expressed in decibels.

**Channel-to-Channel Isolation**

Channel-to-channel isolation is a measure of the level of crosstalk between any two channels. It is measured by applying a full-scale, 100 kHz sine wave signal to all unselected input channels and determining the degree to which the signal attenuates in the selected channel with a 30 kHz signal.

**Power Supply Rejection Ratio (PSRR)**

Variations in power supply affect the full-scale transition but not the linearity of the converter. Power supply rejection is the maximum change in the full-scale transition point due to a change in power supply voltage from the nominal value. See the Typical Performance Characteristics section.

Figure 15 shows the power supply rejection ratio vs. supply ripple frequency for the AD7656A. The power supply rejection ratio is defined as the ratio of the power in the ADC output at the full-scale frequency,  $f$ , to the power of a 200 mV p-p sine wave applied to the  $V_{DD}$  and  $V_{SS}$  supplies of the  $f_{SAMPLE}$  of the ADC.

$$PSRR \text{ (dB)} = 10 \log (P_f/P_{f_s})$$

where:

$P_f$  is equal to the power at frequency  $f$  in the ADC output.

$P_{f_s}$  is equal to the power at frequency  $f_s$  coupled onto the  $V_{DD}$  and  $V_{SS}$  supplies.

**Percent Full-Scale Ratio (%FSR)**

%FSR is calculated using the full theoretical span of the ADC.

## THEORY OF OPERATION

### CONVERTER DETAILS

The AD7656A is a high speed, low power converter that allows the simultaneous sampling of six on-chip analog-to-digital converters (ADCs). The analog inputs on the AD7656A can accept true bipolar input signals. The RANGE pin/RNGx bits are used to select either  $\pm 4 \times V_{REF}$  or  $\pm 2 \times V_{REF}$  as the input range for the next conversion.

The AD7656A contains six successive approximation (SAR) ADCs, six track-and-hold amplifiers, an on-chip 2.5 V reference, reference buffers, and high speed parallel and serial interfaces. The AD7656A allows the simultaneous sampling of all six ADCs when the three CONVST x pins (CONVST A, CONVST B, and CONVST C) are tied together. Alternatively, the six ADCs can be grouped into three pairs. Each pair has an associated CONVST signal used to initiate simultaneous sampling on each ADC pair, on four ADCs, or on all six ADCs. CONVST A is used to initiate simultaneous sampling on V1 and V2, CONVST B is used to initiate simultaneous sampling on V3 and V4, and CONVST C is used to initiate simultaneous sampling on V5 and V6.

A conversion is initiated on the AD7656A by pulsing the CONVST x input. On the rising edge of CONVST x, the track-and-hold amplifier of the selected ADC pair is placed into hold mode and the conversions are started. After the rising edge of CONVST x, the BUSY signal goes high to indicate that the conversion is taking place. The conversion clock for the AD7656A is internally generated, and the conversion time for the device is 3  $\mu$ s. The BUSY signal returns low to indicate the end of conversion. On the falling edge of BUSY, the track-and-hold amplifier returns to track mode. Data can be read from the output register via the parallel or serial interface.

### Track-and-Hold Amplifiers

The track-and-hold amplifiers on the AD7656A allow the ADCs to accurately convert an input sine wave of full-scale amplitude to 16-bit resolution. The input bandwidth of the track-and-hold amplifiers is greater than the Nyquist rate of the ADC, even when the AD7656A is operating at its maximum throughput rate. The device can handle input frequencies of up to 12 MHz.

The track-and-hold amplifiers sample their respective inputs simultaneously on the rising edge of CONVST x. The aperture time (that is, the delay time between the external CONVST x signal actually entering hold) for the track-and-hold is 10 ns. This is well matched across all six track-and-hold amplifiers on one device and from device to device. This allows more than six ADCs to be sampled simultaneously. The end of the conversion is signaled by the falling edge of BUSY, and it is at this point that the track-and-hold amplifiers return to track mode and the acquisition time begins.

### Analog Input

The AD7656A can handle true bipolar input voltages. The logic level on the RANGE pin or the value written to the RNGx bits in the control register determines the analog input range on the AD7656A for the next conversion. When the RANGE pin or RNGx bit is 1, the analog input range for the next conversion is  $\pm 2 \times V_{REF}$ . When the RANGE pin or RNGx bit is 0, the analog input range for the next conversion is  $\pm 4 \times V_{REF}$ .

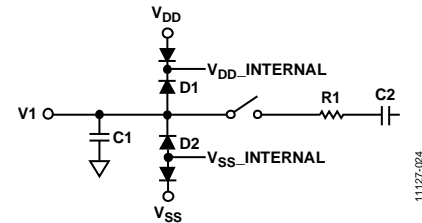

Figure 20. Equivalent Analog Input Structure

Figure 20 shows an equivalent circuit of the analog input of structure of the AD7656A. The two diodes, D1 and D2, provide ESD protection for the analog inputs. Care must be taken to ensure that the analog input signal never exceeds the  $V_{DD}$  and  $V_{SS}$  supply rail limits by more than  $V_{SS} + 1$  V and  $V_{DD} - 1$  V. Signals exceeding this value cause these diode to become forward-biased and to start conducting into the substrate. The maximum current these diodes can conduct without causing irreversible damage to the device is 10 mA. Capacitor C1 in Figure 20 is typically about 4 pF and can be attributed primarily to pin capacitance. Resistor R1 is a lumped component made up of the on resistance of a switch (that is, track-and-hold switch). This resistor is typically about 25  $\Omega$ . Capacitor C2 is the ADC sampling capacitor and has a capacitance of 10 pF typically.

The AD7656A requires  $V_{DD}$  and  $V_{SS}$  dual supplies for the high voltage analog input structures. These supplies must be greater than the analog input range (see Table 6 for the requirements on these supplies for each analog input range). The AD7656A requires a low voltage  $AV_{CC}$  supply of 4.75 V to 5.25 V to power the ADC core, a  $DV_{CC}$  supply of 4.75 V to 5.25 V for the digital power, and a  $V_{DRIVE}$  supply of 2.7 V to 5.25 V for the interface power.

To meet the specified performance when using the minimum supply voltage for the selected analog input range, it may be necessary to reduce the throughput rate from the maximum throughput rate.

Table 6. Minimum  $V_{DD}/V_{SS}$  Supply Voltage Requirements

Analog Input Range (V)	Reference Voltage (V)	Full-Scale Input (V)	Minimum $V_{DD}/V_{SS}$ (V)
$\pm 4 \times V_{REF}$	2.5	$\pm 10$	$\pm 11$
$\pm 4 \times V_{REF}$	3.0	$\pm 12$	$\pm 13$
$\pm 2 \times V_{REF}$	2.5	$\pm 5$	$\pm 6$
$\pm 2 \times V_{REF}$	3.0	$\pm 6$	$\pm 7$

**ADC TRANSFER FUNCTION**

The output coding of the AD7656A is twos complement. The designed code transitions occur midway between successive integer LSB values, that is, 1/2 LSB and 3/2 LSB. The LSB size is  $FSR/65,536$  for the AD7656A. The ideal transfer characteristic is shown in Figure 21.

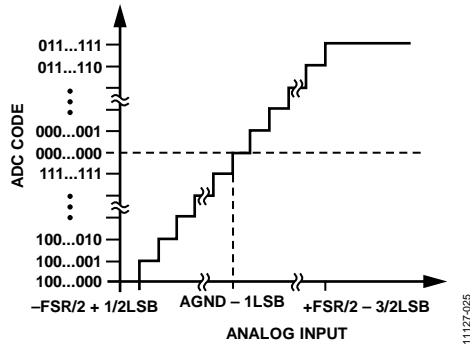

Figure 21. Transfer Characteristic

The LSB size is dependent on the analog input range selected (see Table 7).

**Table 7. LSB Size for Each Analog Input Range**

Input Range (V)	LSB Size (mV)	Full Scale Range
±10	0.305	20 V/65,536
±5	0.152	10 V/65,536

**REFERENCE SECTION**

Either the REFIN/REFOUT pin allows access to the 2.5 V reference of the AD7656A, or it allows an external reference to be connected, providing the reference source for the conversions of the device.

The AD7656A can accommodate a 2.5 V to 3 V external reference range. When using an external reference, the internal reference must be disabled. After a reset, the AD7656A defaults to

operating in external reference mode with the internal reference buffers enabled. The internal reference can be enabled in either hardware or software mode. To enable the internal reference in hardware mode, set the  $\overline{H/S SEL}$  pin to 0 and the  $REF_{EN/DIS}$  pin to 1. To enable the internal reference in software mode, set the  $\overline{H/S SEL}$  pin to 1 and write to the control register to set DB9 of the control register to 1. For the internal reference mode, decouple the REFIN/REFOUT pin using 10  $\mu F$  and 100 nF capacitors.

The AD7656A contains three on-chip reference buffers. Each of the three ADC pairs has an associated reference buffer. These reference buffers require external decoupling capacitors on the REFCAPA, REFCAPB, and REFCAPC pins. Place 10  $\mu F$  and 100 nF decoupling capacitors on these REFCAPx pins. The internal reference buffers can be disabled in software mode by writing to Bit DB8 in the internal control register. If the serial interface is selected, the internal reference buffers can be disabled in hardware mode by setting the DB14/REFBUF $\overline{EN/DIS}$  pin high. If the internal reference and its buffers are disabled, apply an external buffered reference to the REFCAPx pins.

**TYPICAL CONNECTION DIAGRAM**

Figure 22 shows the typical connection diagram for the AD7656A. There are eight AVCC supply pins on the device. The AVCC supply is the supply that is used for the AD7656A conversion process; therefore, it must be well decoupled. Individually decouple each AVCC supply pin with a 10  $\mu F$  tantalum capacitor and a 100 nF ceramic capacitor. The AD7656A can operate with the internal reference or an externally applied reference. In this configuration, the device is configured to operate with the external reference. The REFIN/REFOUT pin is decoupled with a 10  $\mu F$  and 100 nF capacitor pair. The three internal reference buffers are enabled. Each of the REFCAPx pins is decoupled with the 10  $\mu F$  and 100 nF capacitor pair.

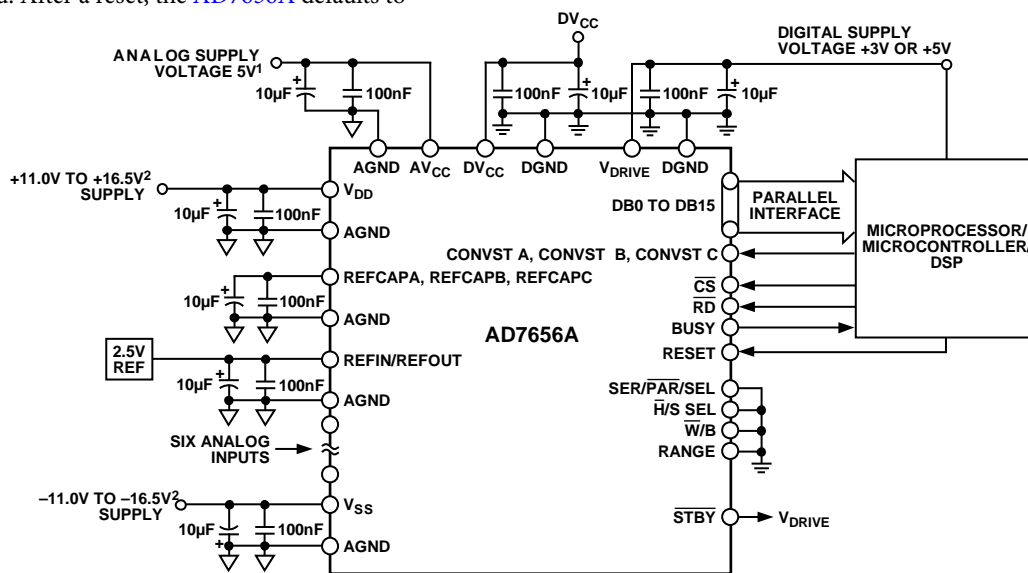

<sup>1</sup>DECOUPLING SHOWN ON THE AVCC PIN APPLIES TO EACH AVCC PIN.  
<sup>2</sup>SEE THE POWER SUPPLY SEQUENCING SECTION.

Figure 22. Typical Connection Diagram



Six of the  $AV_{CC}$  supply pins are used as the supply to the six ADC cores on the AD7656A and, as a result, are used for the conversion process. Each analog input pin is surrounded by an  $AV_{CC}$  supply pin and an AGND pin. These  $AV_{CC}$  and AGND pins are the supply and ground for the individual ADC cores. For example, Pin 33 is V1, Pin 34 is the  $AV_{CC}$  supply for ADC Core 1, and Pin 32 is AGND for ADC Core 1. An alternative reduced decoupling solution is to group these six  $AV_{CC}$  supply pins into three pairs, Pin 34 and Pin 35, Pin 40 and Pin 41, and Pin 46 and Pin 47.

For the AD7656A, a 100  $\mu$ F decoupling capacitor can be placed on each of the pin pairs. Decouple all of the other supply and reference pins with a 10  $\mu$ F decoupling capacitor.

If the same supply is being used for the  $AV_{CC}$  supply and  $DV_{CC}$  supply, place a ferrite or small RC filter between the supply pins.

The AGND pins are connected to the analog ground plane of the system. The DGND pins are connected to the digital ground plane in the system. Connect the AGND and DGND planes together at one place in the system. Make this connection as close as possible to the AD7656A in the system.

The  $V_{DRIVE}$  supply is connected to the same supply as the processor. The voltage on  $V_{DRIVE}$  controls the voltage value of the output logic signals.

Decouple the  $V_{DD}$  and  $V_{SS}$  signals with a minimum 10  $\mu$ F decoupling capacitor. These supplies are used for the high voltage analog input structures on the AD7656A analog inputs.

### DRIVING THE ANALOG INPUTS

Together, the driver amplifier and the analog input circuit used for the AD7656A must settle for a full-scale step input to a 16-bit level (0.0015%), which is within the specified 550 ns acquisition time of the AD7656A. The noise generated by the driver amplifier must be kept as low as possible to preserve the SNR and transition noise performance of the AD7656A. In addition, the driver needs to have a THD performance suitable for the AD7656A.

The AD8021 meets all these requirements. The AD8021 needs an external compensation capacitor of 10 pF. If a dual version of the AD8021 is required, the AD8022 can be used. The AD8610 and the AD797 can also be used to drive the AD7656A.

### INTERFACE SECTION

The AD7656A provides two interface options: a parallel interface and a high speed serial interface. The required interface mode is selected via the SER/PAR SEL pin. The parallel interface can operate in word ( $\overline{W/B} = 0$ ) or byte ( $\overline{W/B} = 1$ ) mode. The interface modes are discussed in the following sections.

#### Parallel Interface ( $SER/\overline{PAR}/SEL = 0$ )

The AD7656A consists of six 16-bit ADCs. A simultaneous sample of all six ADCs can be performed by connecting all three CONVST x pins together (CONVST A, CONVST B, and CONVST C). The AD7656A needs to see a CONVST x pulse to initiate a conversion; this typically consists of a falling CONVST x edge followed by a rising CONVST x edge. The rising edge of CONVST x initiates simultaneous conversions on the selected ADCs. The AD7656A contains an on-chip oscillator that is used to perform the conversions. The conversion time,  $t_{CONVERT}$ , is 3  $\mu$ s. The BUSY signal goes low to indicate the end of conversion. The falling edge of the BUSY signal is used to place the track-and-hold amplifier into track mode. The AD7656A also allows the six ADCs to be converted simultaneously in pairs by pulsing the three CONVST x pins independently. CONVST A is used to initiate simultaneous conversions on V1 and V2, CONVST B is used to initiate simultaneous conversions on V3 and V4, and CONVST C is used to initiate simultaneous conversions on V5 and V6. The conversion results from the simultaneously sampled ADCs are stored in the output data registers.

Data can be read from the AD7656A via the parallel data bus with standard  $\overline{CS}$  and  $\overline{RD}$  signals ( $\overline{W/B} = 0$ ). To read the data over the parallel bus, tie SER/PAR SEL low. The  $\overline{CS}$  and  $\overline{RD}$  input signals are internally gated to enable the conversion result onto the data bus. The data lines, the DB0 to DB15 pins, leave their high impedance state when both  $\overline{CS}$  and  $\overline{RD}$  are logic low.

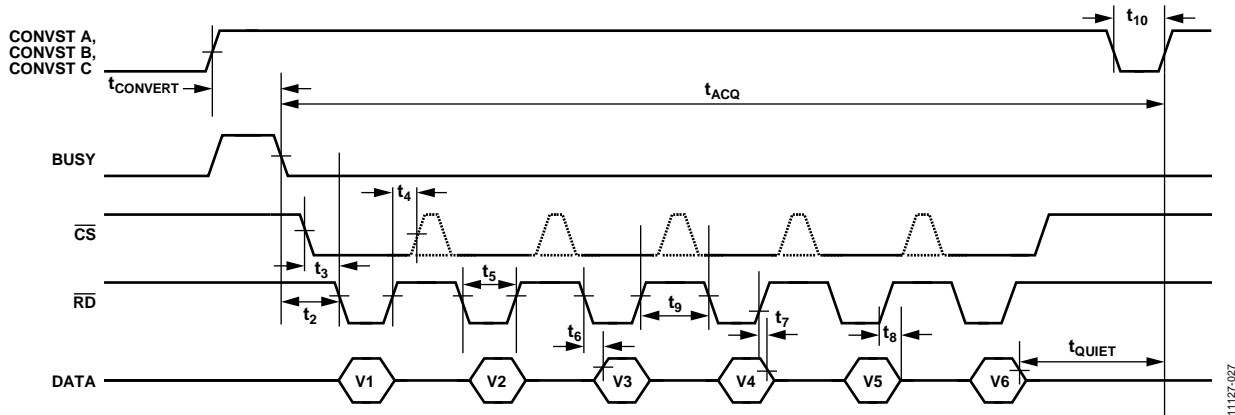
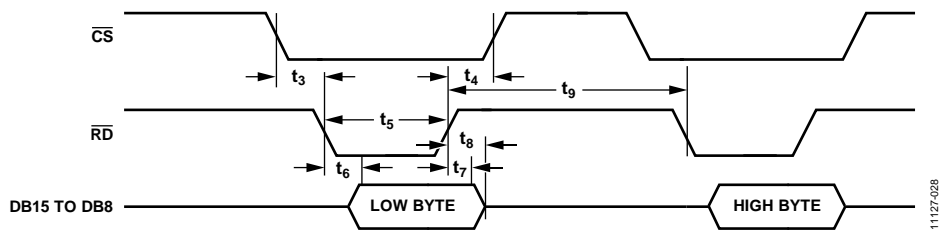
Figure 23. Parallel Interface Timing Diagram ( $\overline{W}/B = 0$ )Figure 24. Parallel Interface—Read Cycle for Byte Mode of Operation ( $\overline{W}/B = 1$ ,  $HBEN = 0$ )

The  $\overline{CS}$  signal can be permanently tied low, and the  $\overline{RD}$  signal can be used to access the conversion results. A read operation can take place after the  $BUSY$  signal goes low. The number of required read operations depends on the number of ADCs that are simultaneously sampled (see Figure 23). If  $CONVST A$  and  $CONVST B$  are simultaneously brought low, four read operations are required to obtain the conversion results from  $V1$ ,  $V2$ ,  $V3$ , and  $V4$ . If  $CONVST A$  and  $CONVST C$  are simultaneously brought low, four read operations are required to obtain the conversion results from  $V1$ ,  $V2$ ,  $V5$ , and  $V6$ . The conversion results are output in ascending order.

When using the three  $CONVST x$  signals to independently initiate conversions on the three ADC pairs, ensure that a conversion is not initiated on a channel pair when the  $BUSY$  signal is high. It is also recommended not to initiate a conversion during a read sequence because doing so can affect the performance of the conversion. For the specified performance, it is recommended to perform the read after the conversion. For unused input channel pairs, tie the associated  $CONVST x$  pin to  $V_{DRIVE}$ .

If there is only an 8-bit bus available, the **AD7656A** interface can be configured to operate in byte mode ( $\overline{W}/B = 1$ ). In this configuration, the  $DB7/HBEN/DCEN$  pin takes on its  $HBEN$  function. Each channel conversion result from the **AD7656A** can be accessed in two read operations, with eight bits of data provided on  $DB15$  to  $DB8$  for each of the read operations (see Figure 24). The  $HBEN$  pin determines whether the read operation first accesses the high byte or the low byte of the 16-bit conversion result. To always access the low byte first on  $DB15$  to  $DB8$ , tie the  $HBEN$  pin low. To always access the high byte first on  $DB15$  to  $DB8$ , tie the  $HBEN$  pin high. In byte mode when all three  $CONVST x$  pins are pulsed together to initiate simultaneous conversions on all six ADCs, 12 read operations are necessary to read back the six 16-bit conversion results. Leave  $DB6$  to  $DB0$  unconnected in byte mode.

**SOFTWARE SELECTION OF ADCS**

The  $\overline{H/S}$  SEL pin determines the source of the combination of ADCs that are to be simultaneously sampled. When the  $\overline{H/S}$  SEL pin is logic low, the combination of channels to be simultaneously sampled is determined by the CONVST A, CONVST B, and CONVST C pins. When the  $\overline{H/S}$  SEL pin is logic high, the combination of channels selected for simultaneous sampling is determined by the contents of the DB15 to DB13 bits in the control register. In this mode, a write to the control register is necessary.

The control register is an 8-bit write-only register. Data is written to this register using the CS and WR pins and the DB15 to DB8 data pins (see Figure 25). The control register is detailed in Table 8. To select an ADC pair to be simultaneously sampled, set the corresponding data line high during the write operation.

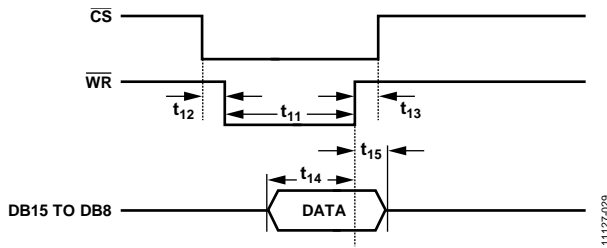

Figure 25. Parallel Interface—Write Cycle for Word Mode ( $\overline{W/B}=0$ )

**Table 8. Control Register Bits (Default All 0s)**

DB15	DB14	DB13	DB12	DB11	DB10	DB9	DB8
VC	VB	VA	RNGC	RNGB	RNGA	REFEN	REFBUF

**Table 9. Control Register Bit Function Descriptions (Default All 0s)**

Bit	Mnemonic	Description
DB15	VC	This bit selects the V5 and V6 analog inputs for the next conversion. When this bit is set to 1, V5 and V6 are simultaneously converted on the next CONVST A rising edge.
DB14	VB	This bit selects the V3 and V4 analog inputs for the next conversion. When this bit is set to 1, V3 and V4 are simultaneously converted on the next CONVST B rising edge.
DB13	VA	This bit selects the V1 and V2 analog inputs for the next conversion. When this bit is set to 1, V1 and V2 are simultaneously converted on the next CONVST C rising edge.
DB12	RNGC	This bit selects the analog input range for the V5 and V6 analog inputs. When this bit is set to 1, the $\pm 2 \times V_{REF}$ range is selected for the next conversion. When this bit is set to 0, the $\pm 4 \times V_{REF}$ range is selected for the next conversion.
DB11	RNGB	This bit selects the analog input range for the V3 and V4 analog inputs. When this bit is set to 1, the $\pm 2 \times V_{REF}$ range is selected for the next conversion. When this bit is set to 0, the $\pm 4 \times V_{REF}$ range is selected for the next conversion.
DB10	RNGA	This bit selects the analog input range for the V1 and V2 analog inputs. When this bit is set to 1, the $\pm 2 \times V_{REF}$ range is selected for the next conversion. When this bit is set to 0, the $\pm 4 \times V_{REF}$ range is selected for the next conversion.
DB9	REFEN	This bit selects the internal reference or an external reference. When this bit is set to 0, the external reference mode is selected. When this bit is set to 1, the internal reference is selected.
DB8	REFBUF	This bit selects between using the internal reference buffers and choosing to bypass these reference buffers. When this bit is set to 0, the internal reference buffers are enabled and decoupling is required on the REFCAPx pins. When this bit is set to 1, the internal reference buffers are disabled and a buffered reference is applied to the REFCAPx pins.

The AD7656A control register allows individual ranges to be programmed on each ADC pair. DB12 to DB10 bits in the control register are used to program the range on each ADC pair.

After a reset occurs on the AD7656A, the control register contains all zeros.

The CONVST A signal is used to initiate a simultaneous conversion on the combination of channels selected via the control register. The CONVST B and CONVST C signals can be tied low when operating in software mode ( $\overline{H/S}$  SEL = 1). The number of read pulses required depends on the number of ADCs selected in the control register and on whether the devices are operating in word or byte mode. The conversion results are output in ascending order.

During the write operation, Data Bus Bit DB15 to Data Bus Bit DB8 are bidirectional and become inputs to the control register when  $\overline{RD}$  is logic high and  $\overline{CS}$  and  $\overline{WR}$  are logic low. The logic state on DB15 through DB8 is latched into the control register when  $\overline{WR}$  goes logic high.

### Changing the Analog Input Range ( $\overline{H/S SEL} = 0$ )

The AD7656A RANGE pin allows the user to select either  $\pm 2 \times V_{REF}$  or  $\pm 4 \times V_{REF}$  as the analog input range for the six analog inputs. When the  $\overline{H/S SEL}$  pin is low, the logic state of the RANGE pin is sampled on the falling edge of the BUSY signal to determine the range for the next simultaneous conversion. When the RANGE pin is logic high at the falling edge of the BUSY signal, the range for the next conversion is  $\pm 2 \times V_{REF}$ . When the RANGE pin is logic low at the falling edge of the BUSY signal, the range for the next conversion is  $\pm 4 \times V_{REF}$ . After a RESET pulse, the range is updated on the first falling BUSY edge after the RESET pulse.

### Changing the Analog Input Range ( $\overline{H/S SEL} = 1$ )

When the  $\overline{H/S SEL}$  pin is high, the range can be changed by writing to the control register. Bits[DB12:DB10] in the control register are used to select the analog input ranges for the next conversion. Each analog input pair has an associated range bit, allowing independent ranges to be programmed on each ADC pair. When the RNGx bit is set to 1, the range for the next conversion is  $\pm 2 \times V_{REF}$ . When the RNGx bit is set to 0, the range for the next conversion is  $\pm 4 \times V_{REF}$ .

### Serial Interface ( $SER/\overline{PAR/SEL} = 1$ )

By pulsing one, two, or all three CONVST x signals, the AD7656A use their on-chip trimmed oscillator to simultaneously convert the selected channel pairs on the rising edge of CONVST x. After the rising edge of CONVST x, the BUSY signal goes high to indicate that the conversion has started. It returns low when the conversion is complete 3  $\mu$ s later. The output register is loaded with the new conversion results, and data can be read from the AD7656A. To read the data back from the device over the serial interface, tie  $SER/\overline{PAR}$  high. The  $\overline{CS}$  and SCLK signals are used to transfer data from the AD7656A. The device has three DOUT x pins: DOUT A, DOUT B, and DOUT C. Data can be read back from the device using one, two, or all three DOUT x lines.

Figure 26 shows six simultaneous conversions and the read sequence using three DOUT x lines. Also in Figure 26, 32 SCLK transfers are used to access data from the AD7656A; however, two 16 SCLK individually framed transfers with the  $\overline{CS}$  signal can also be used to access the data on the three DOUT x lines. When the serial interface is selected and the conversion data clocks out on all three DOUTx lines, tie DB0/SEL A, DB1/SEL B, and DB2/SEL C to  $V_{DRIVE}$ . These pins are used to enable the DOUT A to DOUT C lines, respectively.

If it is required to clock conversion data out on two data out lines, use DOUT A and DOUT B. To enable DOUT A and DOUT B, tie DB0/SEL A and DB1/SEL B to  $V_{DRIVE}$  and tie DB2/SEL C low. When six simultaneous conversions are performed and only two DOUT x lines are used, a 48 SCLK transfer can be used to access the data from the AD7656A. The read sequence is shown in Figure 27 for a simultaneous conversion on all six ADCs using two DOUT x lines. If a simultaneous conversion occurred on all six ADCs, only two DOUT x lines are used to read the results from the AD7656A. DOUT A clocks out the result from V1, V2, and V5, and DOUT B clocks out the results from V3, V4, and V6.

Data can also be clocked out using just one DOUT x line, in which case, use DOUT A to access the conversion data. To configure the AD7656A to operate in this mode, tie DB0/SEL A to  $V_{DRIVE}$  and tie DB1/SEL B and DB2/SEL C low. The disadvantage of using only one DOUT x line is that the throughput rate is reduced. Data can be accessed from the AD7656A using one 96-SCLK transfer, three 32-SCLK individually framed transfers, or six 16-SCLK individually framed transfers. In serial mode, tie the  $\overline{RD}$  signal low. Leave the unused DOUT x line(s) unconnected in serial mode.

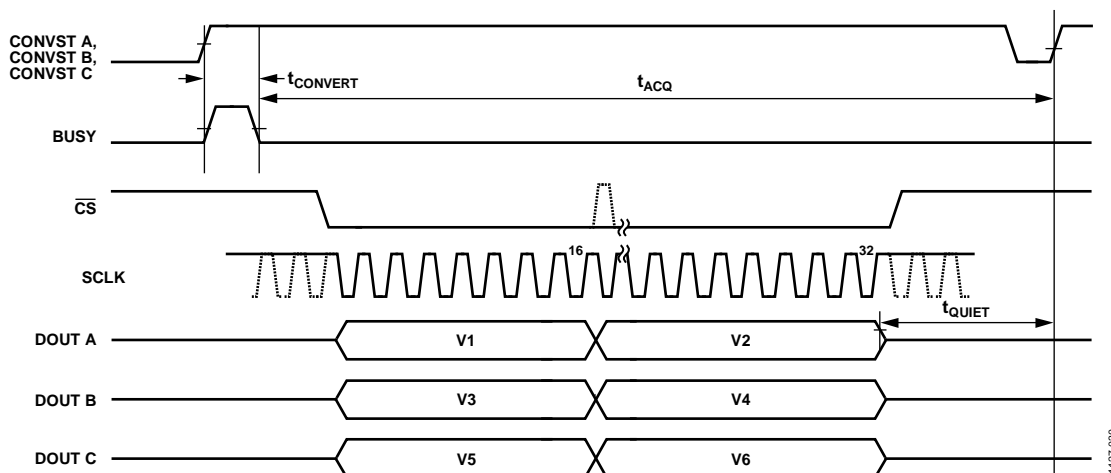

Figure 26. Serial Interface with Three DOUT x Lines

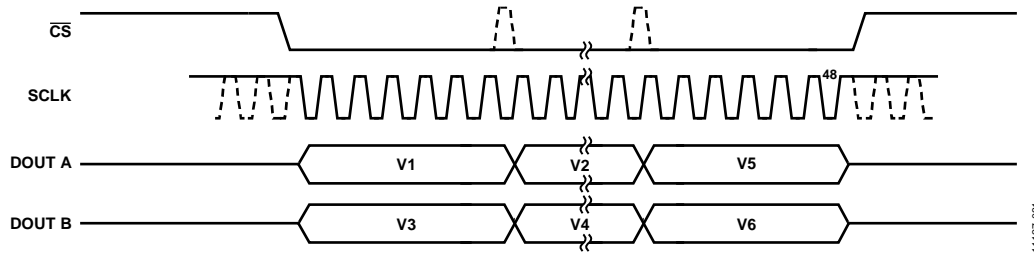

Figure 27. Serial Interface with Two DOUT x Lines

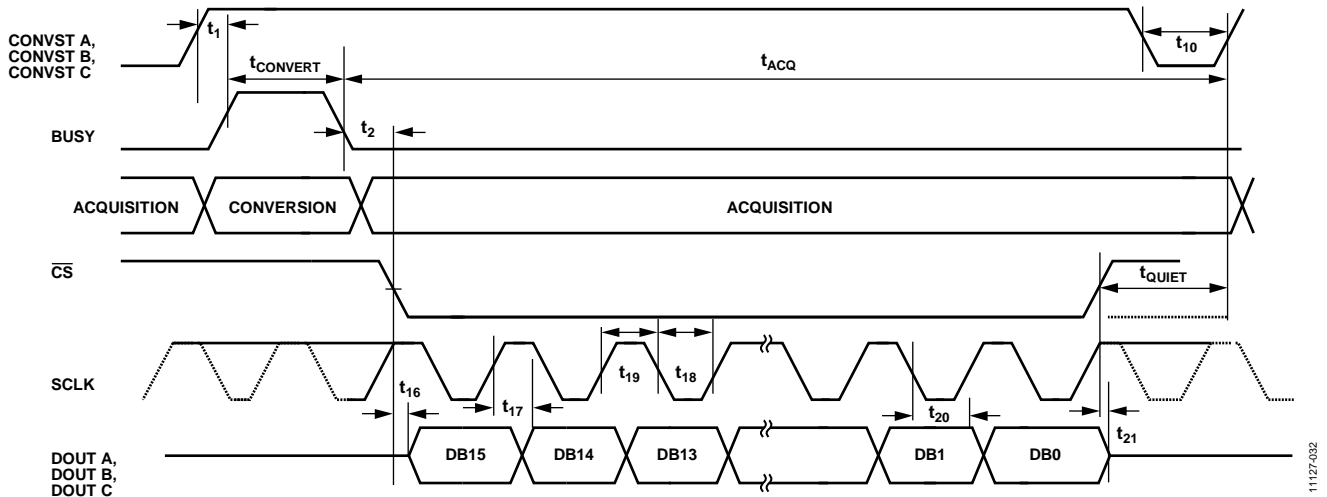

Figure 28. Serial Read Operation

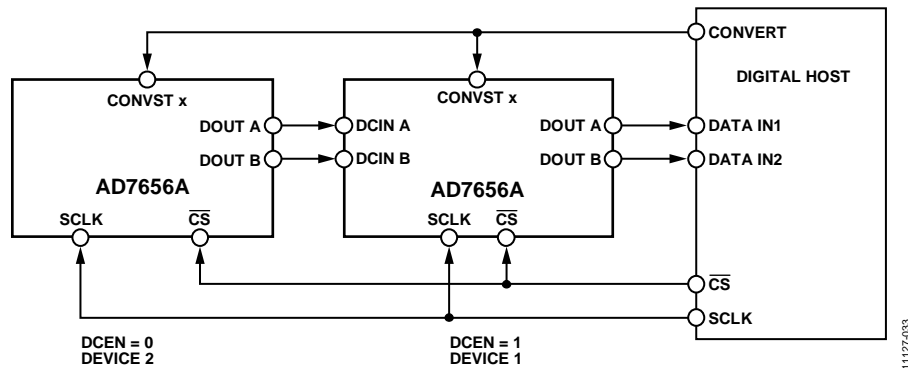

Figure 29. Daisy-Chain Configuration

**SERIAL READ OPERATION**

Figure 28 shows the timing diagram for reading data from the AD7656A serial interface. The SCLK input signal provides the clock source for the serial interface. The CS signal goes low to access data from the AD7656A. The falling edge of CS takes the bus out of a three-state condition and clocks out the MSB of the 16-bit conversion result. The ADCs output 16 bits for each conversion result; the data stream of the AD7656A consists of 16 bits of conversion data provided MSB first.

The first bit of the conversion result is valid on the first SCLK falling edge after the CS falling edge. The subsequent 15 data bits are clocked out on the rising edge of the SCLK signal. Data is valid on the SCLK falling edge. To access each conversion result,

provide 16 clock pulses to the AD7656A. Figure 28 shows how a 16-SCLK read is used to access the conversion results.

**DAISY-CHAIN MODE (DCEN = 1, SER/PAR/SEL = 1)**

When reading conversion data back from the AD7656A using their three, two, and one DOUT x pins, it is possible to configure the device to operate in daisy-chain mode using the DCEN pin. This daisy-chain feature allows multiple AD7656A devices to be cascaded together and is useful for reducing the component count and wiring connections. An example connection of two devices is shown in Figure 29. This configuration shows the use of two DOUT x lines. Simultaneous sampling of the 12 analog inputs is possible by using a common CONVST x signal. The DB5, DB4, and DB3 pins are used as the DCIN A to DCIN C data input pins for the daisy-chain mode.

The rising edge of CONVST x is used to initiate a conversion on the AD7656A. After the BUSY signal has gone low to indicate that the conversion is complete, the user can begin to read the data from the two devices. Figure 30 shows the serial timing diagram when operating two AD7656A devices in daisy-chain mode.

The CS falling edge is used to frame the serial transfer from the AD7656A to take the bus out of three-state and to clock out the MSB of the first conversion result. In the example shown in Figure 30, all 12 ADC channels are simultaneously sampled. Two DOUT x lines are used to read the conversion results in this example. CS frames a 96-SCLK transfer. During the first 48 SCLKs, the conversion data is transferred from Device 2 to Device 1. DOUT A on Device 2 transfers conversion data from V1, V2, and V5 into DCIN A in Device 1. DOUT B on Device 2 transfers conversion results from V3, V4, and V6 to DCIN B in Device 1.

During the first 48 SCLKs, Device 1 transfers data into the digital host. DOUT A on Device 1 transfers conversion data from V1, V2, and V5. DOUT B on Device 1 transfers conversion data from V3, V4, and V6. During the last 48-SCLKs, Device 2 clocks out zeros and Device 1 shifts the data clocked in from Device 2 during the first 48 SCLKs into the digital host. This example can also be implemented using six 16-SCLK individually framed transfers if DCEN remains high during the transfers.

Figure 31 shows the timing if two AD7656A devices are configured in daisy-chain mode and are operating with three DOUT x lines. Assuming a simultaneous sampling of all 12 inputs occurs, the CS frames a 64-SCLK transfer during the read operation. During the first 32 SCLKs of this transfer, the conversion results from Device 1 are clocked into the digital host, and the conversion results from Device 2 are clocked into Device 1. During the last 32 SCLKs of the transfer, the conversion results from Device 2 are clocked out of Device 1 and into the digital host. Device 2 clocks out zeros.

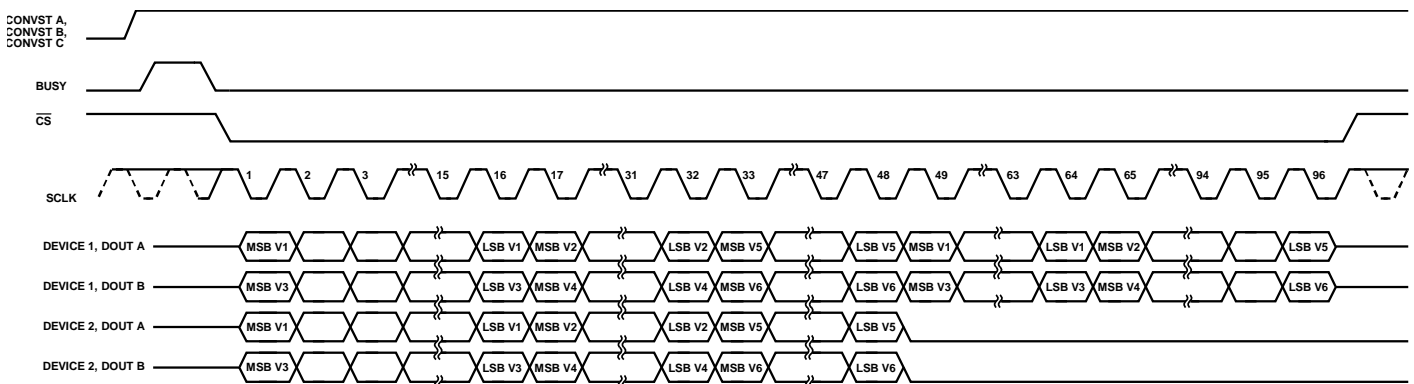

Figure 30. Daisy-Chain Serial Interface Timing with Two DOUT x Lines

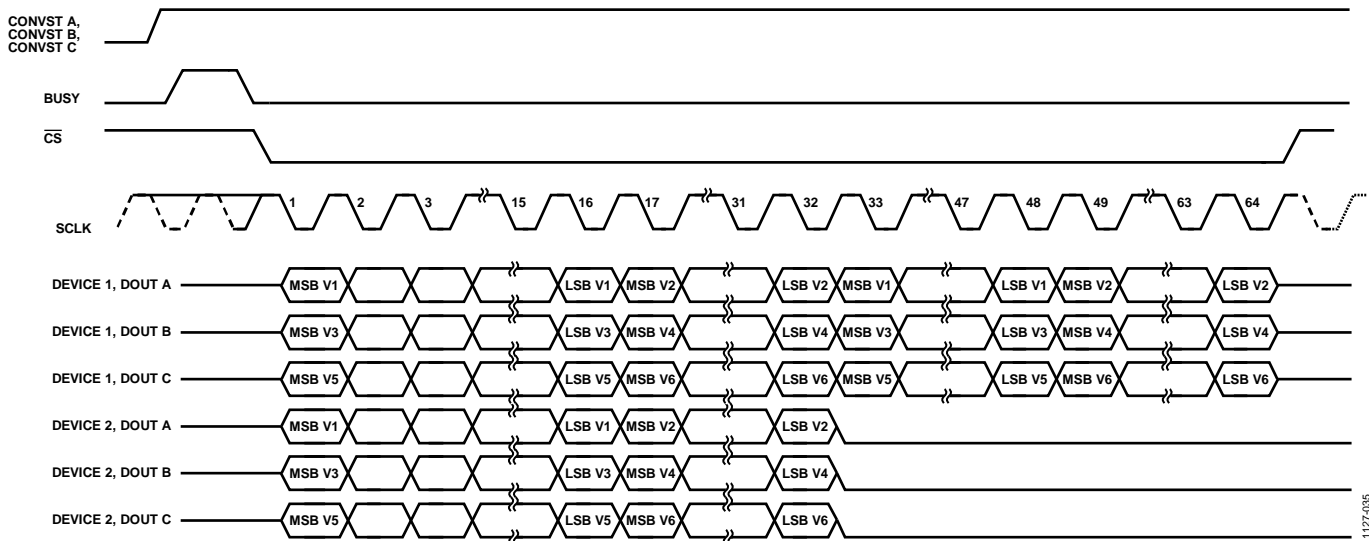

Figure 31. Daisy-Chain Serial Interface Timing with Three DOUT x Lines

**Standby/Partial Power-Down Modes of Operation  
(SER/PAR/SEL = 0 or SER/PAR/SEL = 1)**

Each ADC pair can be individually placed into partial power-down mode by bringing the CONVST x signal low before the falling edge of BUSY. Bring the CONVST x signal high to power up the ADC pair and place the track-and-hold amplifier into track mode. After the power-up time from the partial power-down has elapsed, the CONVST x signal typically receives a rising edge to initiate a valid conversion. In partial power-down mode, the reference buffers remain powered up. While an ADC pair is in partial power-down mode, conversions can still occur on the other ADCs.

The AD7656A has a power-down mode whereby the device can be placed into a low power mode consuming 100 mW maximum. The AD7656A is placed into standby mode by bringing the

logic input  $\overline{\text{STBY}}$  low and can be powered up again for normal operation by bringing  $\overline{\text{STBY}}$  logic high. The output data buffers are still operational when the AD7656A is in standby mode, meaning the user can continue to access the conversion results of the device. This standby feature can be used to reduce the average power consumed by the AD7656A when operating at lower throughput rates. The AD7656A can be placed into standby at the end of each conversion when BUSY goes low and taken out of standby again prior to the next conversion. The wake-up time is when the AD7656A comes out of standby mode. The wake-up time limits the maximum throughput rate at which the AD7656A can operate when powering down between conversions. See the Specifications section.

## APPLICATION HINTS

### LAYOUT

Design the printed circuit board (PCB) that houses the [AD7656A](#) so that the analog and digital sections are separated and confined to different areas of the board.

Use at least one ground plane. The ground plane can be common or split between the digital and analog sections. In the case of the split plane, join the digital and analog ground planes in only one place, preferably underneath the [AD7656A](#), or at least as close as possible to the device.

If the [AD7656A](#) is in a system where multiple devices require analog-to-digital ground connections, still make the connection at only one point, a star ground point, and established it as close as possible to the [AD7656A](#). Make good connections to the ground plane. Avoid sharing one connection for multiple ground pins. Use individual vias or multiple vias to the ground plane for each ground pin.

Avoid running digital lines under the device because doing so couples noise onto the die. Allow the analog ground plane to run under the [AD7656A](#) to avoid noise coupling. Shield fast switching signals, like CONVST x or clocks, with digital ground to avoid radiating noise to other sections of the board, and ensure that they never run near the analog signal paths. Avoid crossover of digital and analog signals. Run traces in close proximity on the board at right angles to each other to reduce the effect of feedthrough through the board.

For the power supply lines to the  $AV_{CC}$ ,  $DV_{CC}$ ,  $V_{DRIVE}$ ,  $V_{DD}$ , and  $V_{SS}$  pins on the [AD7656A](#) use as large a trace as possible to provide low impedance paths and to reduce the effect of glitches on the power supply lines. Establish good connections between the [AD7656A](#) supply pins and the power tracks on the board; involve the use of a single via or multiple vias for each supply pin.

Good decoupling is also important to lower the supply impedance presented to the [AD7656A](#) and to reduce the magnitude of the supply spikes. Place decoupling ceramic capacitors, typically 100 nF, on all of the power supply pins,  $V_{DD}$ ,  $V_{SS}$ ,  $AV_{CC}$ ,  $DV_{CC}$ , and  $V_{DRIVE}$ . Place these decoupling capacitors close to, but ideally right up against, these pins and their corresponding ground pins. Additionally, place low ESR 10  $\mu$ F capacitors on each of the supply pins. Avoid sharing these capacitors between pins. Use big vias to connect the capacitors to the power and ground planes. Use wide, short traces between the via and the capacitor pad, or place the via adjacent to the capacitor pad to minimize parasitic inductances. Recommended decoupling capacitors are 100 nF, low ESR, ceramic capacitors and 10  $\mu$ F, low ESR, tantalum capacitors for the  $AV_{CC}$  decoupling. Place a large tantalum decoupling capacitor where the  $AV_{CC}$  supply enters the board.

An alternative reduced decoupling arrangement is outlined in the Typical Connection Diagram section. This decoupling arrangement groups the  $AV_{CC}$  supply pins into pairs and allows the decoupling capacitors to be shared between the supply pairs. Group the six  $AV_{CC}$  core supply pins into three pairs, Pin 34 and Pin 35, Pin 40 and Pin 41, and Pin 46 and Pin 47. Connect the supply pins in each pair together; their location on the [AD7656A](#) pin configuration easily facilitates this. For the [AD7656A](#), decouple each pair with a 100  $\mu$ F capacitor. For this minimum decoupling configuration, decouple all other supply and reference pins with a 10  $\mu$ F decoupling capacitor.



# OUTLINE DIMENSIONS

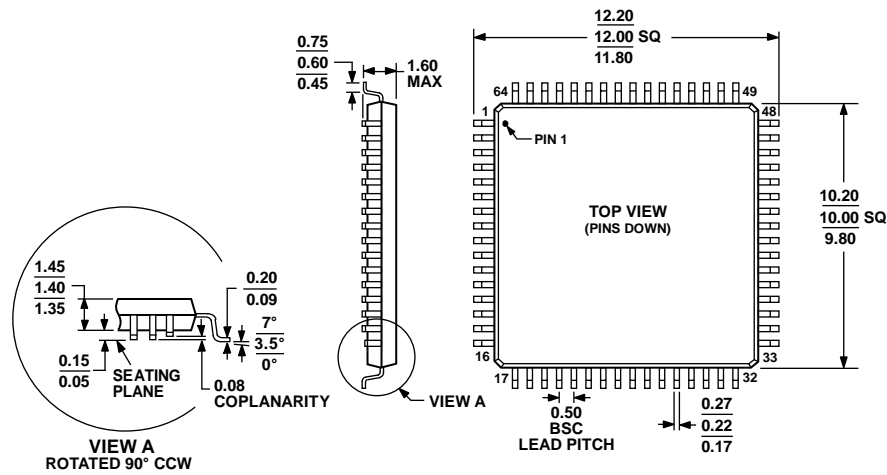

COMPLIANT TO JEDEC STANDARDS MS-026-BCD

Figure 32. 64-Lead Low Profile Quad Flat Package [LQFP] (ST-64-2)

Dimensions shown in millimeters

051706-A

## ORDERING GUIDE

Model <sup>1</sup>	Temperature Range	Package Description	Package Option
AD7656ABSTZ	-40°C to +85°C	64-Lead Low Profile Quad Flat Package [LQFP]	ST-64-2
AD7656ABSTZ-RL	-40°C to +85°C	64-Lead Low Profile Quad Flat Package [LQFP]	ST-64-2

<sup>1</sup> Z = RoHS Compliant Part.

**NOTES**

**NOTES**

**NOTES**

Компания «Life Electronics» занимается поставками электронных компонентов импортного и отечественного производства от производителей и со складов крупных дистрибьюторов Европы, Америки и Азии.

С конца 2013 года компания активно расширяет линейку поставок компонентов по направлению коаксиальный кабель, кварцевые генераторы и конденсаторы (керамические, пленочные, электролитические), за счёт заключения дистрибьюторских договоров

Мы предлагаем:

- Конкурентоспособные цены и скидки постоянным клиентам.
- Специальные условия для постоянных клиентов.
- Подбор аналогов.
- Поставку компонентов в любых объемах, удовлетворяющих вашим потребностям.
- Приемлемые сроки поставки, возможна ускоренная поставка.
- Доставку товара в любую точку России и стран СНГ.
- Комплексную поставку.
- Работу по проектам и поставку образцов.
- Формирование склада под заказчика.
- Сертификаты соответствия на поставляемую продукцию (по желанию клиента).
- Тестирование поставляемой продукции.
- Поставку компонентов, требующих военную и космическую приемку.
- Входной контроль качества.
- Наличие сертификата ISO.

В составе нашей компании организован Конструкторский отдел, призванный помогать разработчикам, и инженерам.

Конструкторский отдел помогает осуществить:

- Регистрацию проекта у производителя компонентов.
- Техническую поддержку проекта.
- Защиту от снятия компонента с производства.
- Оценку стоимости проекта по компонентам.
- Изготовление тестовой платы монтаж и пусконаладочные работы.



Тел: +7 (812) 336 43 04 (многоканальный)  
Email: [org@lifeelectronics.ru](mailto:org@lifeelectronics.ru)