



Rail-to-Rail Output, High Quality Audio, Dual Operational Amplifier

■ GENERAL DESCRIPTION

The MUSES8832 is a Rail-to-Rail output High quality audio operational amplifier, which is optimized for high-end audio and portable audio applications.

The MUSES8832 features 2.1nV/ $\sqrt{\text{Hz}}$ low noise, 10MHz wide gain bandwidth, 0.0009% low distortion, 600 Ω drive capability, -40°C to +125°C operating temperature range, and various reliabilities and conveniences are improved.

It is the best for audio preamplifiers, active filters, microphone amplifiers, and line amplifiers with excellent sound.

■ APPLICATIONS

- Home Audio
- PC Audio
- Portable Audio
- Car Audio

■ FEATURES

- Operating Voltage +2.7V to +14V
 $\pm 1.35\text{V}$ to $\pm 7.0\text{V}$
- Low Noise 2.1nV/ $\sqrt{\text{Hz}}$ typ. at f=1kHz
 0.3 μVrms typ. (20Hz to 20kHz)
- Output Current 32mA typ. (Capability of driving 600 Ω loads)
- GBW 10MHz typ.
- Low Distortion 0.0009% typ. at $V_{\text{+}}=+5\text{V}$, $V_{\text{o}}=1.3\text{Vrms}$
- Slew Rate 1V/ μs typ.
- Bipolar Technology
- Package Outline SOP8 JEDEC 150 mil, SSOP8-A3
- Operating Temperature Range -40 to +125°C

■ PACKAGE OUTLINE



MUSES8832E
(SOP8 JEDEC 150 mil)



MUSES8832VA3
(SSOP8-A3)

■ PIN CONFIGURATION

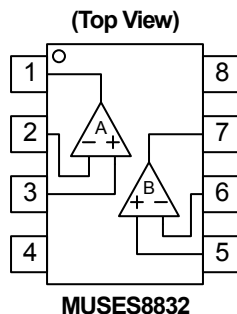

PIN FUNCTION

1. A OUTPUT
2. A -INPUT
3. A +INPUT
4. V-
5. B +INPUT
6. B -INPUT
7. B OUTPUT
8. V+



MUSES and this logo are trademarks of New Japan Radio Co., Ltd.

MUSES8832

■ ABSOLUTE MAXIMUM RATINGS (Ta=25°C)

PARAMETER	SYMBOL	RATING	UNIT
Supply Voltage	V^+ (V^+V)	+15 (± 7.5)	V
Input Voltage	V_{IN}	+15 (Note1)	V
Differential Input Voltage	V_{ID}	± 15	V
Power Dissipation	P_D	SOP8 JEDEC 150 mil: 900 SSOP8-A3: 650(Note2)	mW
Operating Temperature Range	T_{opr}	-40 to +125	°C
Storage Temperature Range	T_{stg}	-65 to +150	°C

(Note1) For supply Voltages less than +15 V, the maximum input voltage is equal to the Supply Voltage.

(Note2) Mounted on the EIA/JEDEC standard board (114.3×76.2×1.6mm, two layer, FR-4).

■ RECOMMENDED OPERATING CONDITION (Ta=25°C)

PARAMETER	SYMBOL	TEST CONDITION	MIN.	TYP.	MAX.	UNIT
Supply Voltage	V^+		+2.7	-	+14.0	V
	V^+V		± 1.35	-	± 7.0	V

■ ELECTRIC CHARACTERISTICS

$V^+ = +5V$, $V = 0V$, $T_a = 25^\circ C$, R_L to $V^+/2$, unless otherwise specified

PARAMETER	SYMBOL	TEST CONDITION	MIN.	TYP.	MAX.	UNIT
Supply Current	I_{CC}	No Signal, $R_L = \infty$	-	7.5	10	mA
Power Dissipation	P_D	No Signal	-	42.5	60	mW
Input Offset Voltage	V_{IO}	$R_S = 50\Omega$	-	0.1	0.5	mV
Input Bias Current	I_B		-	4	6.5	μA
Input Offset Current	I_{IO}		-	100	500	nA
Open-Loop Voltage Gain	A_V	$R_L = 10k\Omega$ to $V^+/2$, $V_O = 0.5$ to $4.5V$	90	115	-	dB
Common Mode Input Voltage Range	V_{ICM}	CMR ≥ 90 dB	0.5	-	3.7	V
Common Mode Rejection Ratio	CMR	$R_S = 50\Omega$	90	110	-	dB
Supply Voltage Rejection Ratio	SVR	$R_S = 50\Omega$	90	105	-	dB
Maximum Output Voltage 1	V_{OH1}	$R_L = 10k\Omega$ to $0V$	4.9	4.95	-	V
	V_{OL1}	$R_L = 10k\Omega$ to $0V$	-	0.05	0.1	V
Maximum Output Voltage 2	V_{OH2}	$R_L = 600\Omega$ to $V^+/2$	4.8	4.9	-	V
	V_{OL2}	$R_L = 600\Omega$ to $V^+/2$	-	0.1	0.2	V
Output Source Current	I_{SOURCE}	$V_O = V^+ - 0.5V$	10	32	-	mA
Output Sink Current	I_{SINK}	$V_O = 0.5V$	10	20	-	mA
Gain Bandwidth Product	GBW	$f = 10kHz$	-	10	-	MHz
Slew Rate	SR	$R_L = 2k\Omega$	-	1	-	V/ μs
Total Harmonic Distortion + Noise	THD+N	Gain=10, $V_O = 1.3V_{rms}$, $R_L = 2k\Omega$, $f = 1kHz$	-	0.0009	-	%
Channel Separation	CS	Gain=100, $R_S = 1k\Omega$, $R_L = 10k\Omega$, $f = 1kHz$	-	140	-	dB
Input Noise Voltage1	e_n	$f = 1kHz$	-	2.1	-	nV/ \sqrt{Hz}
Input Noise Voltage2	V_n	$f = 20Hz$ to $20kHz$	-	0.30	-	μV_{rms}

■ NOTE

1. The closed gain should be 6dB or higher to prevent the oscillation. Unity gain follower application may cause the oscillation.
2. Minimize the load capacitor for the better performance. A large load capacitor CL reduces the frequency response and causes oscillation or ringing.
3. Be careful to the circuit of high impedance. Input bias current influences an input noise and output offset voltage.

■ APPLICATION CIRCUIT

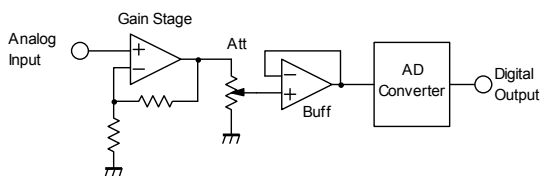

(Fig.1:ADC Input)

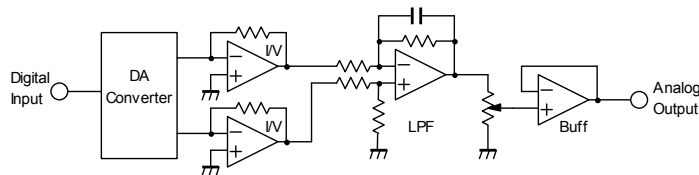

(Fig.2:DAC Output)

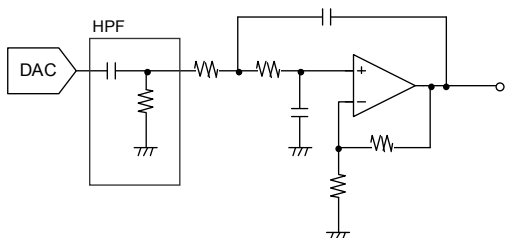

(Fig.3:DAC LPF Circuit)

MUSES8832

■ TYPICAL CHARACTERISTICS ($V^- = 0V$, $V_{CM} = V^+ / 2$, unless otherwise specified)

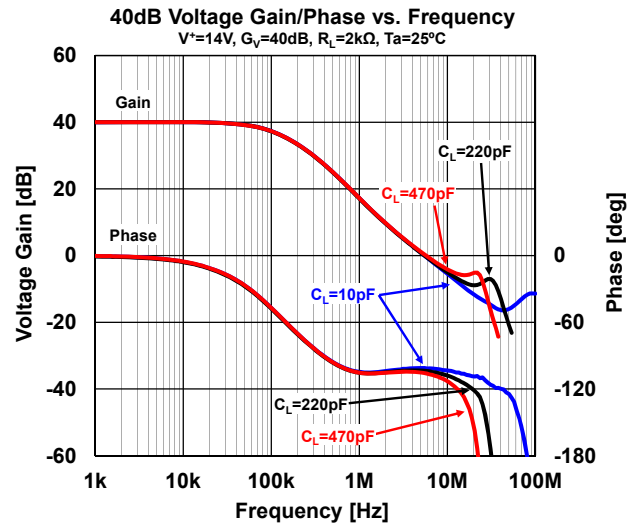
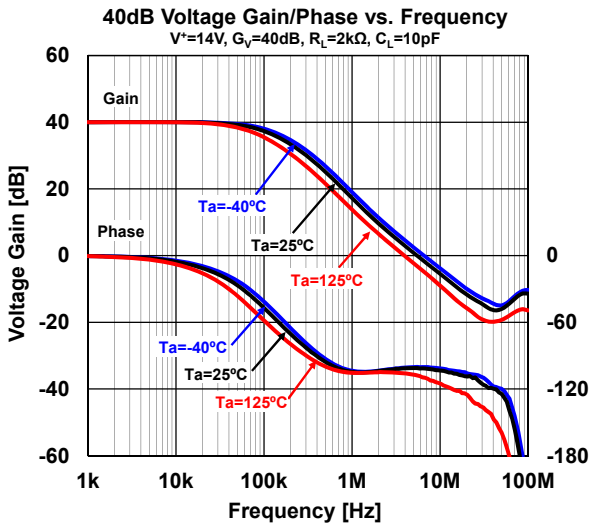
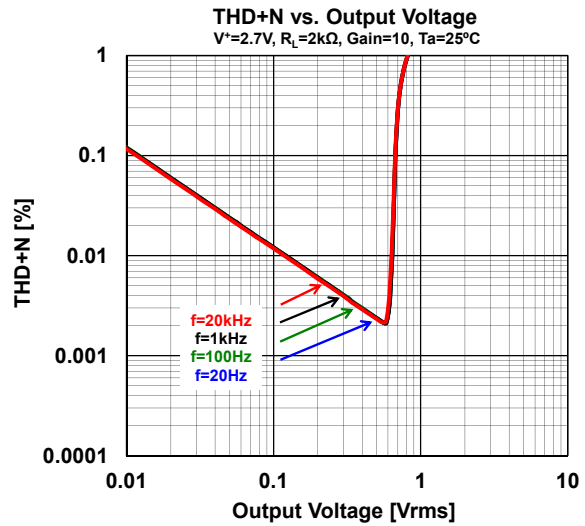
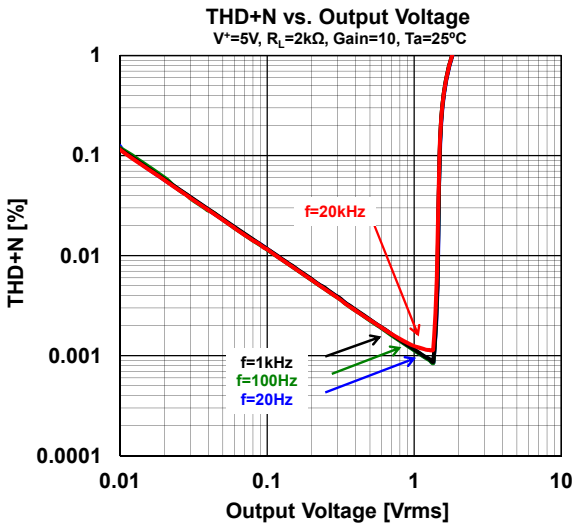
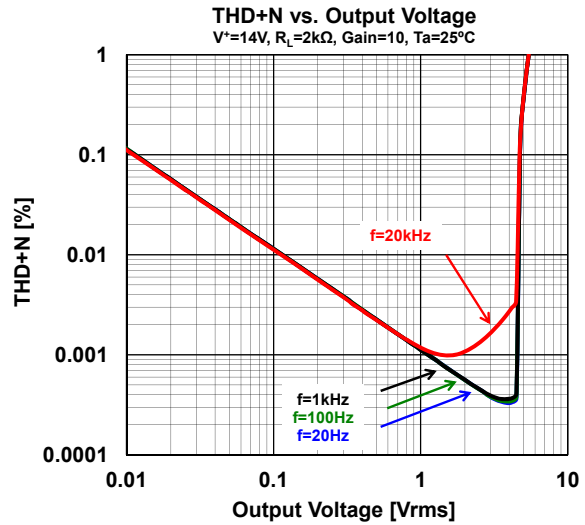
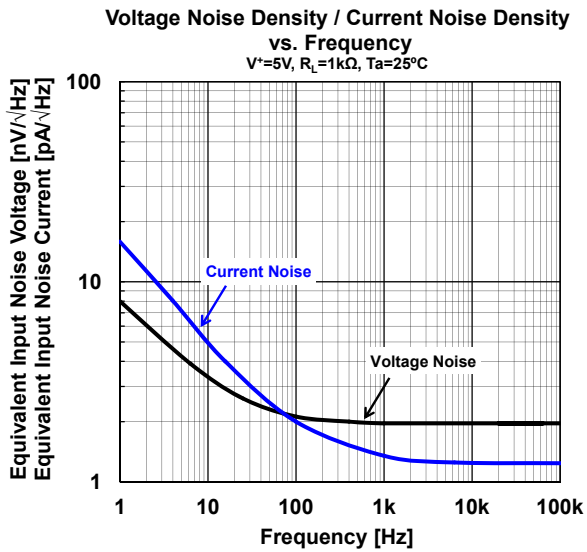

■ TYPICAL CHARACTERISTICS ($V^- = 0V$, $V_{CM} = V^+ / 2$, unless otherwise specified)

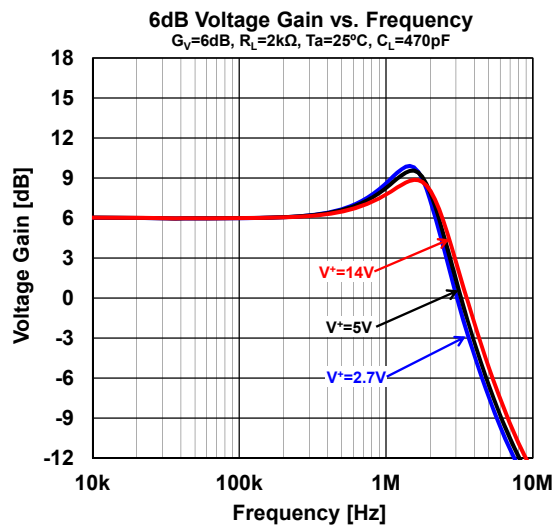
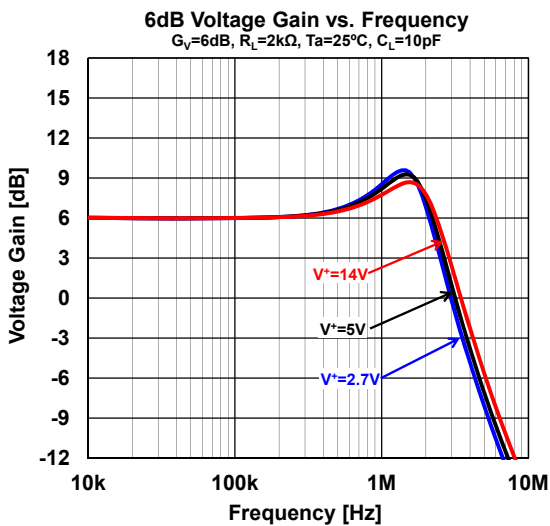
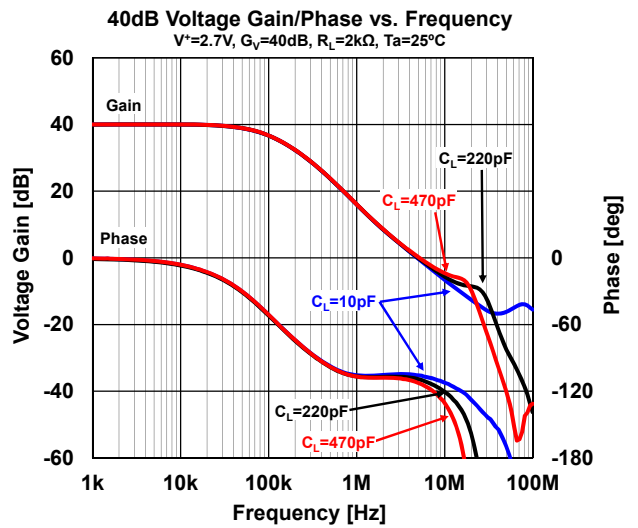
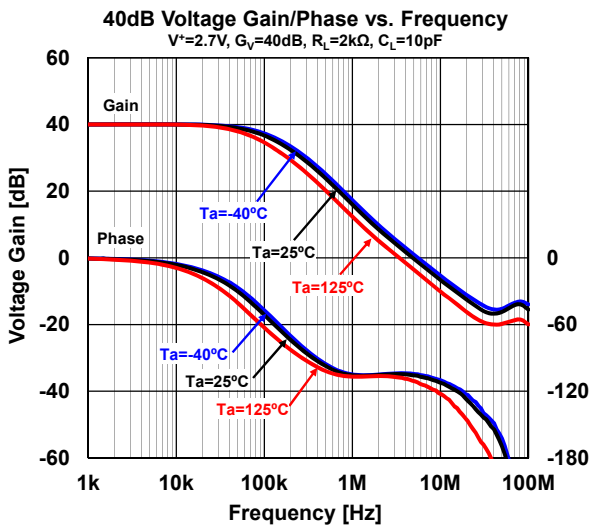
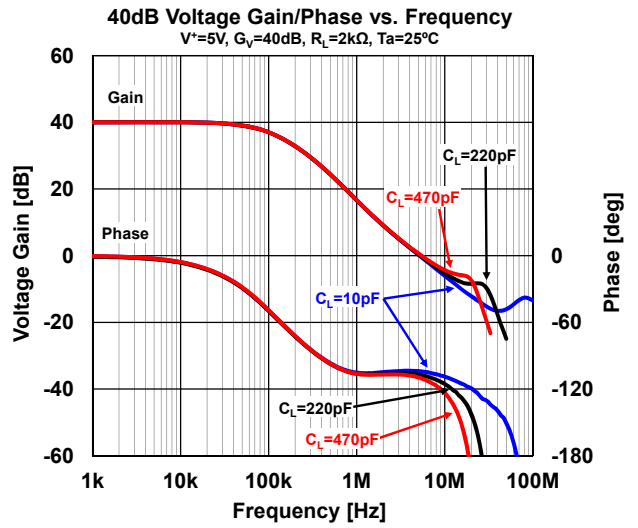
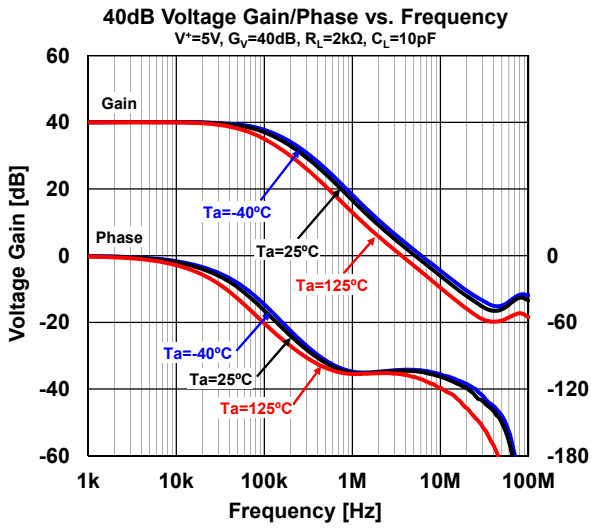

MUSES8832

■ TYPICAL CHARACTERISTICS ($V^- = 0V$, $V_{CM} = V^+ / 2$, unless otherwise specified)

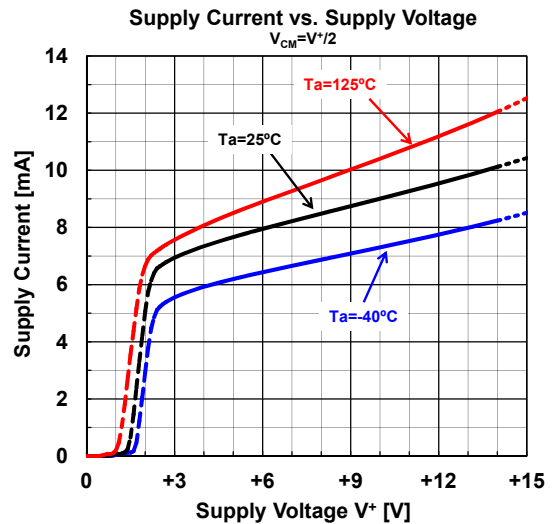
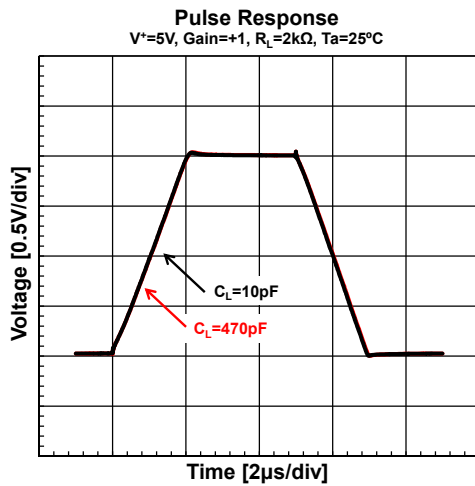
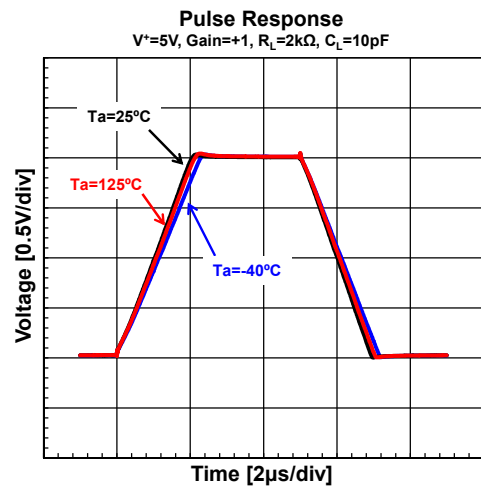
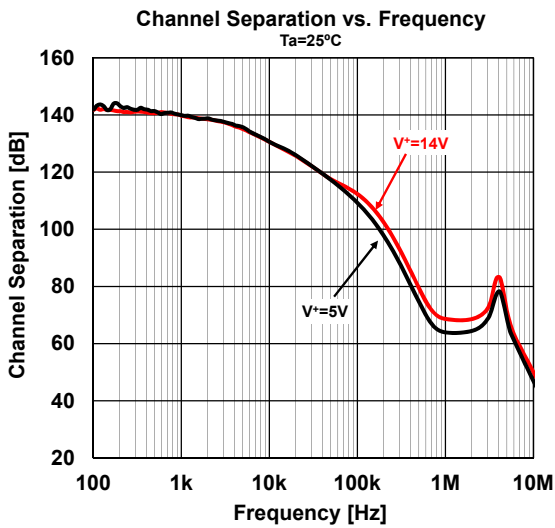
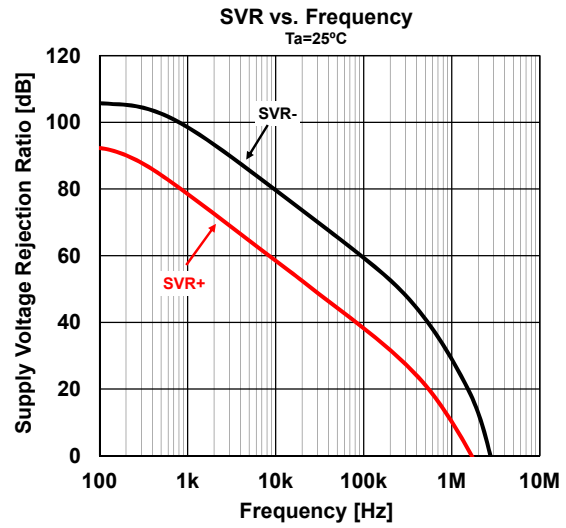
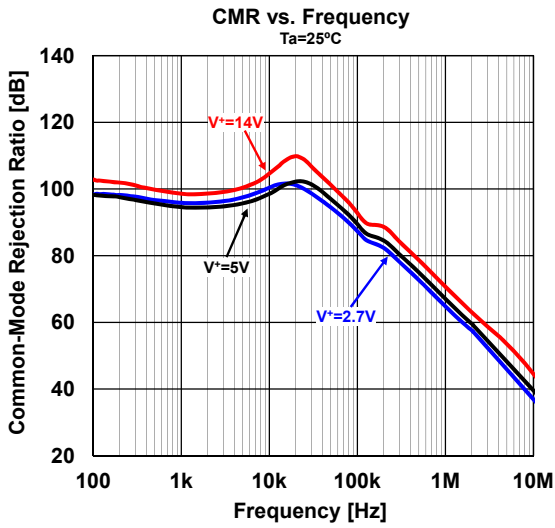

■ TYPICAL CHARACTERISTICS ($V^- = 0V$, $V_{CM} = V^+ / 2$, unless otherwise specified)

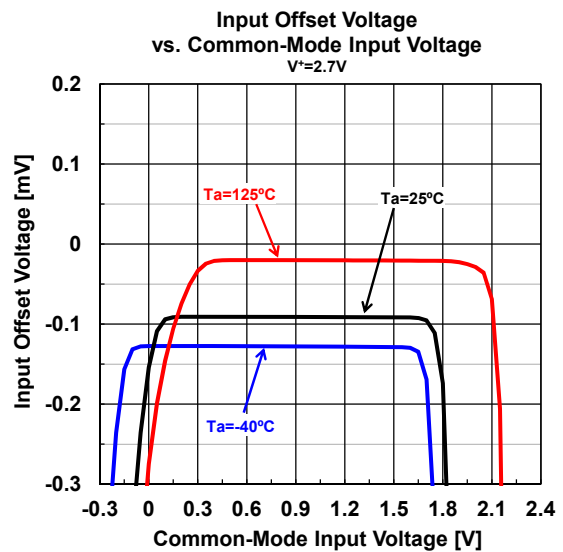
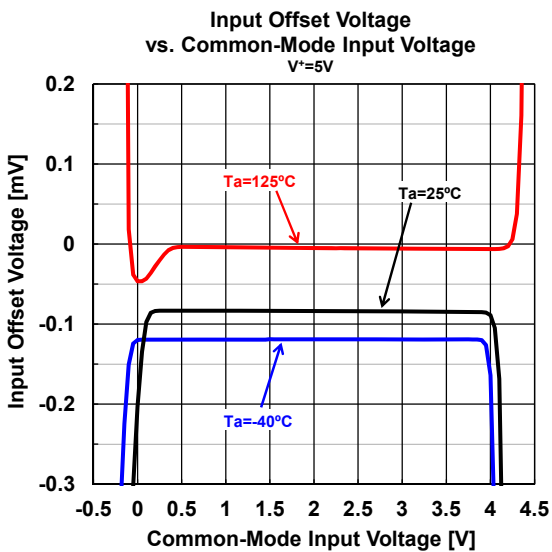
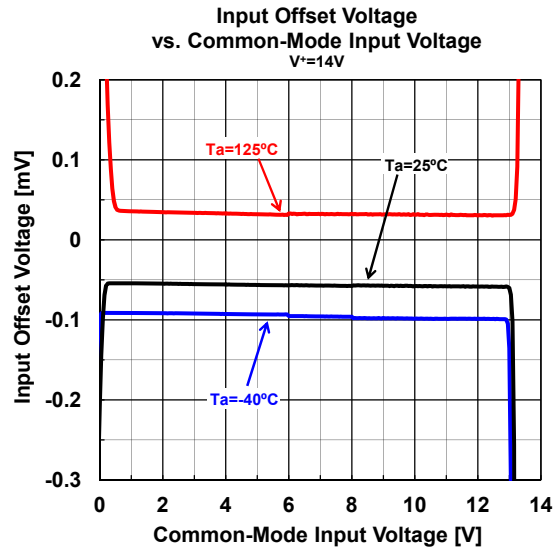
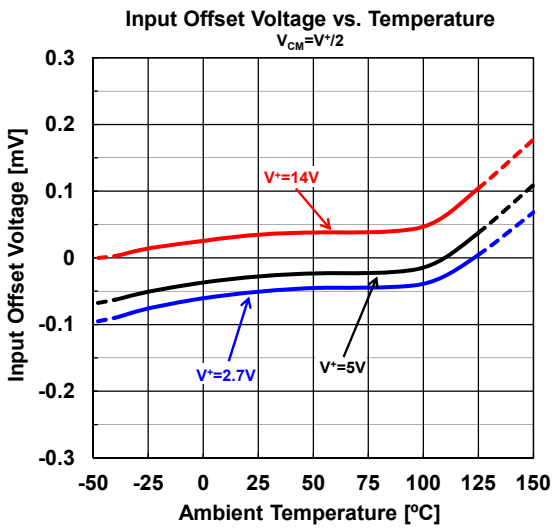
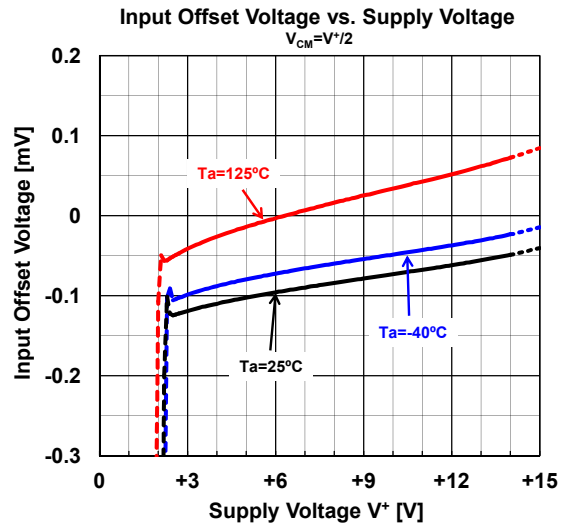
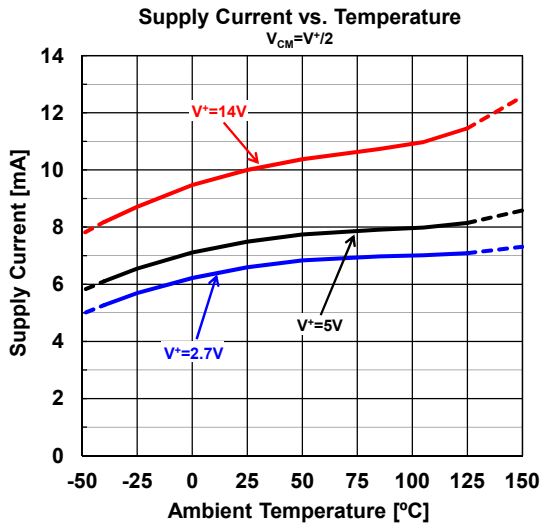

MUSES8832

■ TYPICAL CHARACTERISTICS ($V^- = 0V$, $V_{CM} = V^+ / 2$, unless otherwise specified)

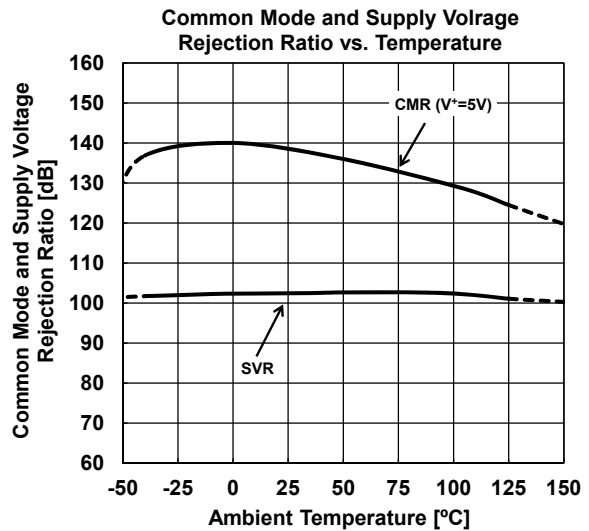
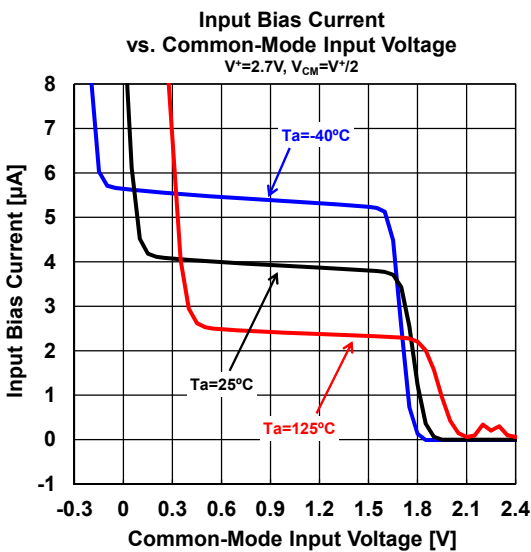
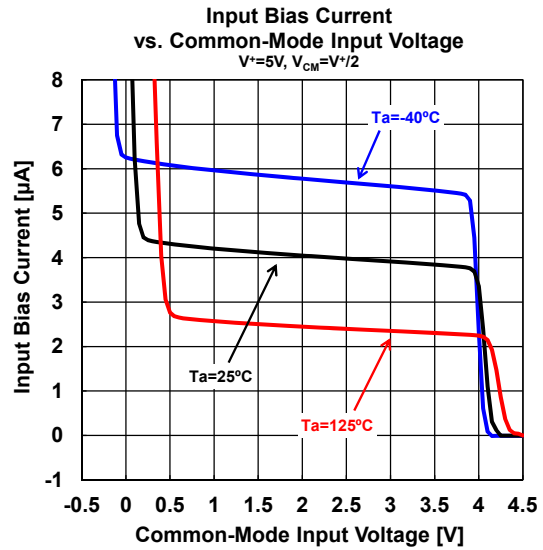
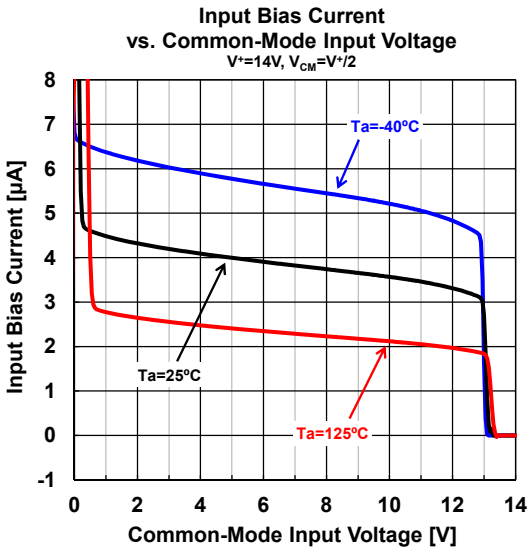
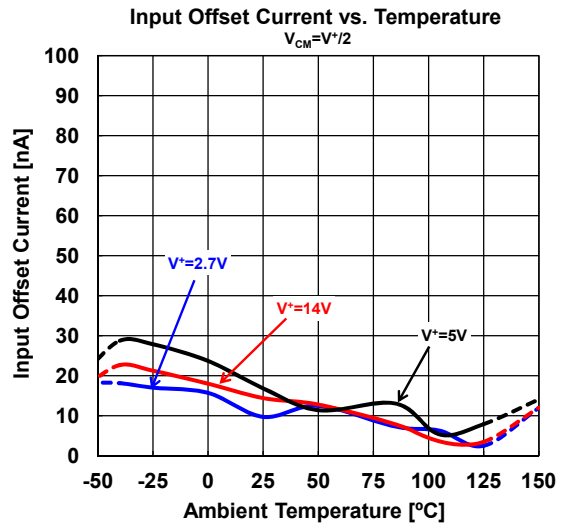
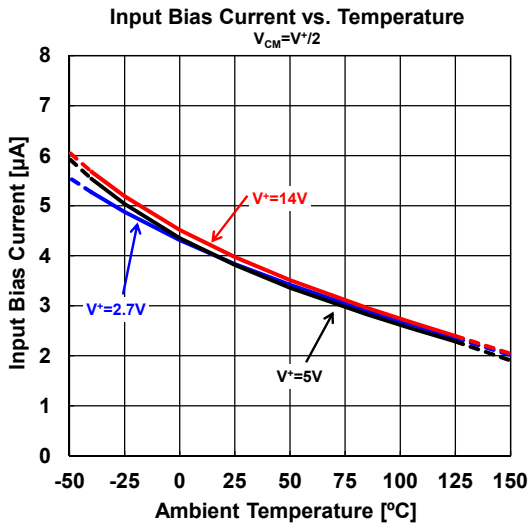

■ TYPICAL CHARACTERISTICS ($V^- = 0V$, $V_{CM} = V^+ / 2$, unless otherwise specified)

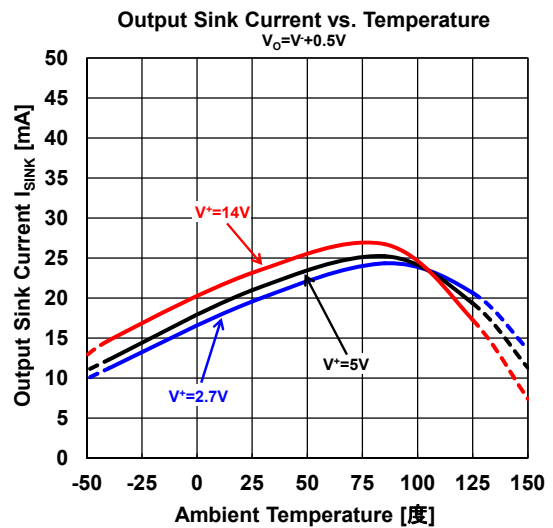
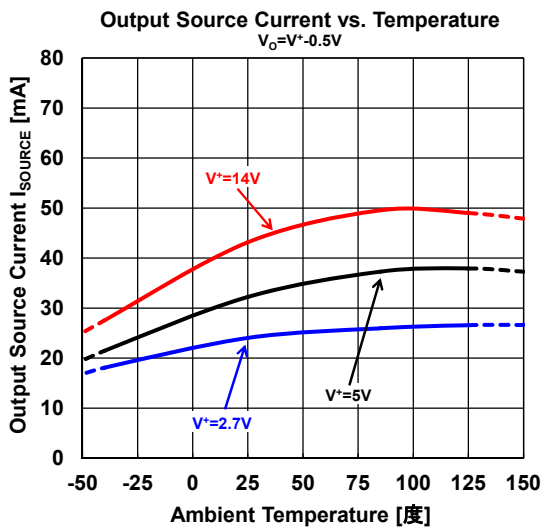
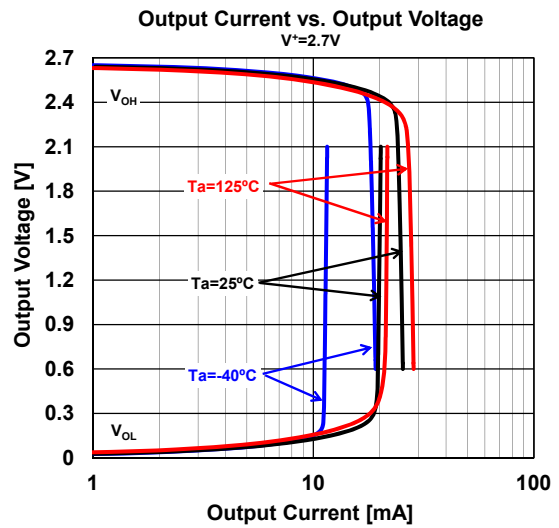
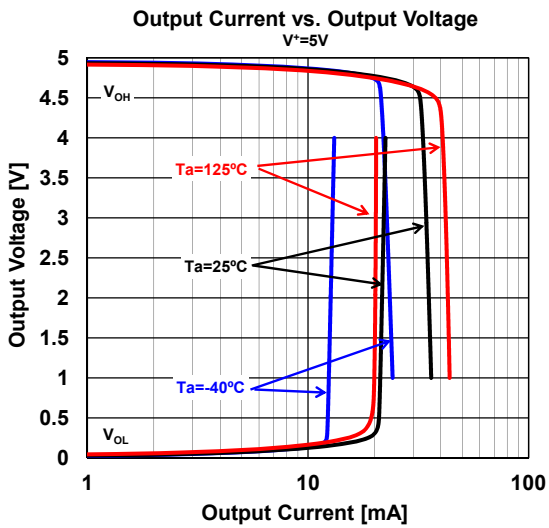
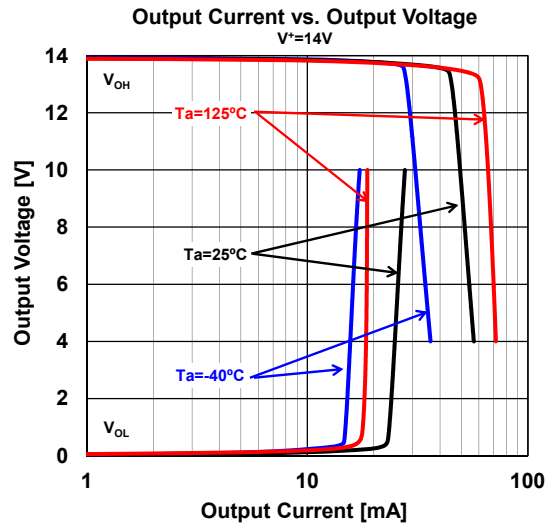
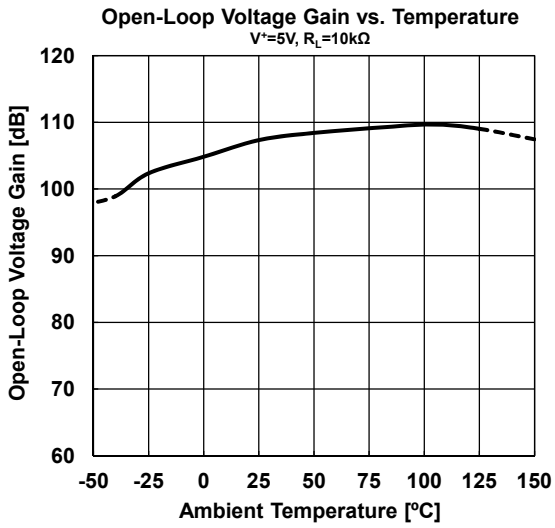

MUSES8832

■ TYPICAL CHARACTERISTICS ($V^- = 0V$, $V_{CM} = V^+ / 2$, unless otherwise specified)

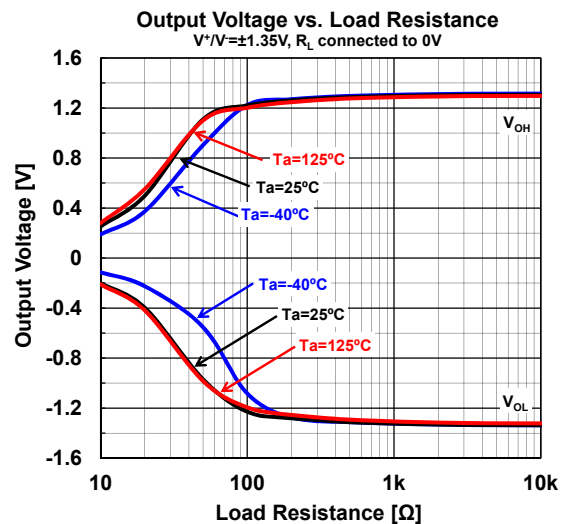
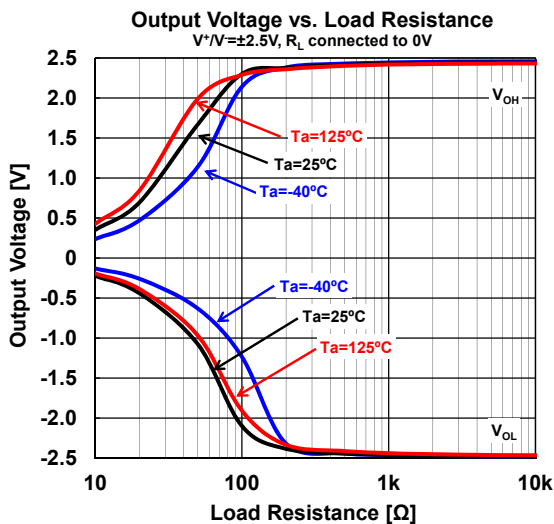
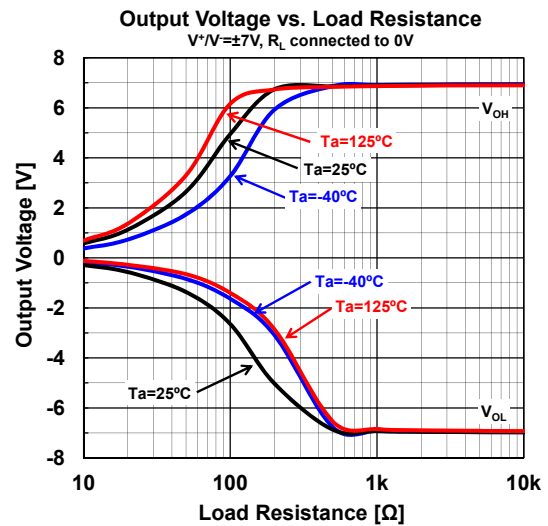
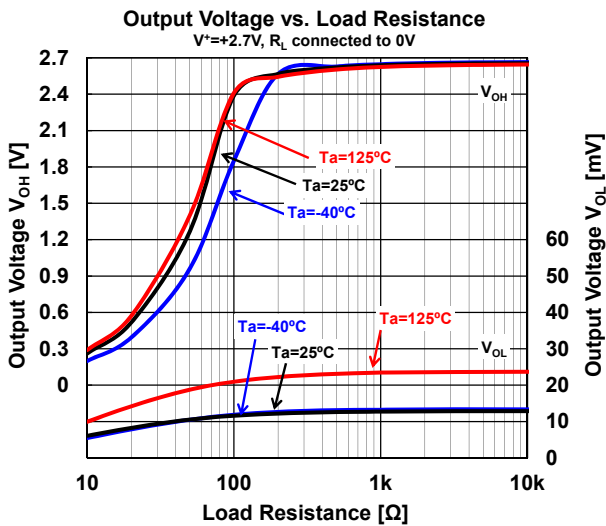
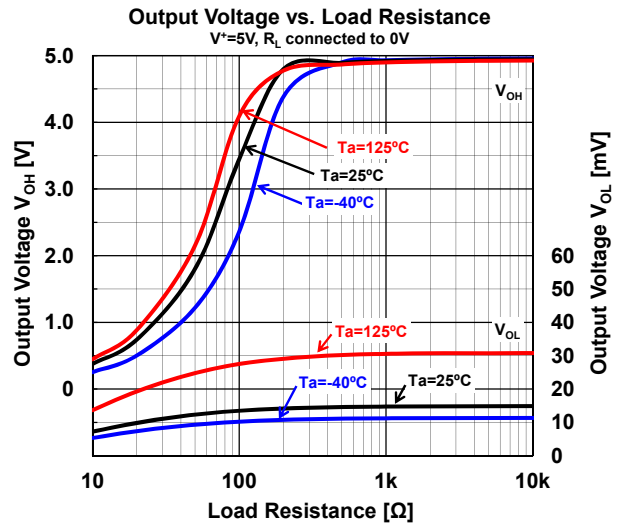
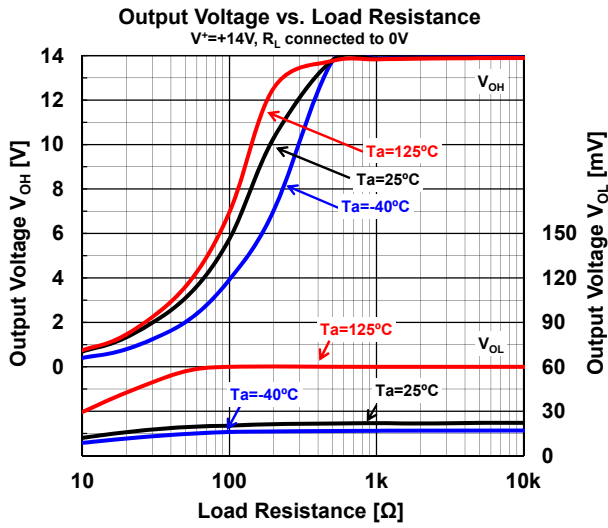

■ MEMO

[CAUTION]
The specifications on this databook are only given for information, without any guarantee as regards either mistakes or omissions. The application circuits in this databook are described only to show representative usages of the product and not intended for the guarantee or permission of any right including the industrial rights.

Mouser Electronics

Authorized Distributor

Click to View Pricing, Inventory, Delivery & Lifecycle Information:

[NJR:](#)

[MUSES8832E](#) [MUSES8832VA3](#)

Компания «Life Electronics» занимается поставками электронных компонентов импортного и отечественного производства от производителей и со складов крупных дистрибьюторов Европы, Америки и Азии.

С конца 2013 года компания активно расширяет линейку поставок компонентов по направлению коаксиальный кабель, кварцевые генераторы и конденсаторы (керамические, пленочные, электролитические), за счёт заключения дистрибьюторских договоров

Мы предлагаем:

- Конкурентоспособные цены и скидки постоянным клиентам.
- Специальные условия для постоянных клиентов.
- Подбор аналогов.
- Поставку компонентов в любых объемах, удовлетворяющих вашим потребностям.
- Приемлемые сроки поставки, возможна ускоренная поставка.
- Доставку товара в любую точку России и стран СНГ.
- Комплексную поставку.
- Работу по проектам и поставку образцов.
- Формирование склада под заказчика.
- Сертификаты соответствия на поставляемую продукцию (по желанию клиента).
- Тестирование поставляемой продукции.
- Поставку компонентов, требующих военную и космическую приемку.
- Входной контроль качества.
- Наличие сертификата ISO.

В составе нашей компании организован Конструкторский отдел, призванный помогать разработчикам, и инженерам.

Конструкторский отдел помогает осуществить:

- Регистрацию проекта у производителя компонентов.
- Техническую поддержку проекта.
- Защиту от снятия компонента с производства.
- Оценку стоимости проекта по компонентам.
- Изготовление тестовой платы монтаж и пусконаладочные работы.



Тел: +7 (812) 336 43 04 (многоканальный)

Email: org@lifeelectronics.ru