

Low Noise Quasi-Resonant Control DC/DC converter IC for AC/DC Converter



BD7682FJ-LB BD7683FJ-LB BD7684FJ-LB BD7685FJ-LB

General Description

This product guarantees long time support in the Industrial market.

BD768xFJ series is a Quasi-resonant controller type DC/DC converters that provide an optimum system for all products that include an electrical outlet. Quasi-resonant operation enables soft switching and helps to keep EMI low. Design with a high degree of flexibility is achieved with switching MOSFETs and current detection resistors as external devices.

The built-in brown out function monitors the input voltage as part of system optimization. The burst mode function reduces input power at low power.

BD768xFJ series include various protection functions, such as a soft start function, burst function, per-cycle over-current limiter function, overvoltage protection function, overload protection function, and brown out function.

BD768xFJ series include a gate-clamp circuit for optimal driving SIC-MOSFET.

Features

- Pin 8 : SOP-J8 Package (6.00mm × 4.90mm : 1.27mm pitch <TYP>)
- Quasi-resonant type (low EMI)
- Frequency reduction mode
- Low current consumption (19µA), during standby
- Low current consumption when no load (burst operation when light load)
- Maximum frequency (120kHz)
- CS Pin Leading-Edge Blanking
- VCC UVLO (Under Voltage Drop Out protection)
- VCC OVP (Over Voltage Protection)
- Per-cycle over-current protection circuit
- Soft start
- ZT trigger mask function
- Voltage protection function (brown out)
- ZT OVP (Over Voltage Protection)
- Gate-clamp circuit

Key Specifications

- Operating Power Supply Voltage Range: VCC 15.0V to 27.5V
- Normal Operating Current: 0.80mA(Typ)
- Burst Operating Current: 0.50mA(Typ)
- Maximum Frequency: 120kHz(Typ)
- Operating Temperature: -40°C to +105°C

Package 4.90mm x 6.00mm x 1.65mm pitch 1.27mm
(Typ.) (Typ.) (TYP.) (TYP.)

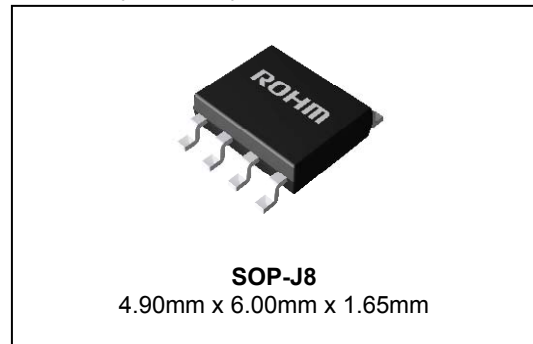

Lineup

	FBOLP	VCCOVP
BD7682FJ	AutoRestart	Latch
BD7683FJ	Latch	Latch
BD7684FJ	AutoRestart	AutoRestart
BD7685FJ	Latch	AutoRestart

Applications

Industrial equipment, AC Adaptor, Household appliances

Typical Application Circuit

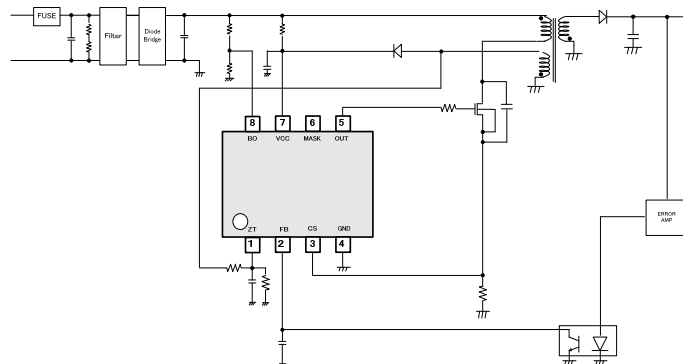

Pin Descriptions

No.	Pin Name	I/O	Function	ESD Diode	
				VCC	GND
1	ZT	I	Zero Current Detect pin	-	✓
2	FB	I	Feedback signal input pin	✓	✓
3	CS	I	Current Sense pin	✓	✓
4	GND	I/O	GND pin	✓	-
5	OUT	O	MOSFET drive pin	✓	✓
6	MASK	O	External TR drive	-	✓
7	VCC	I	Power Supply pin	-	✓
8	BO	O	Brown IN/OUT monitor pin	-	✓

Block Diagram

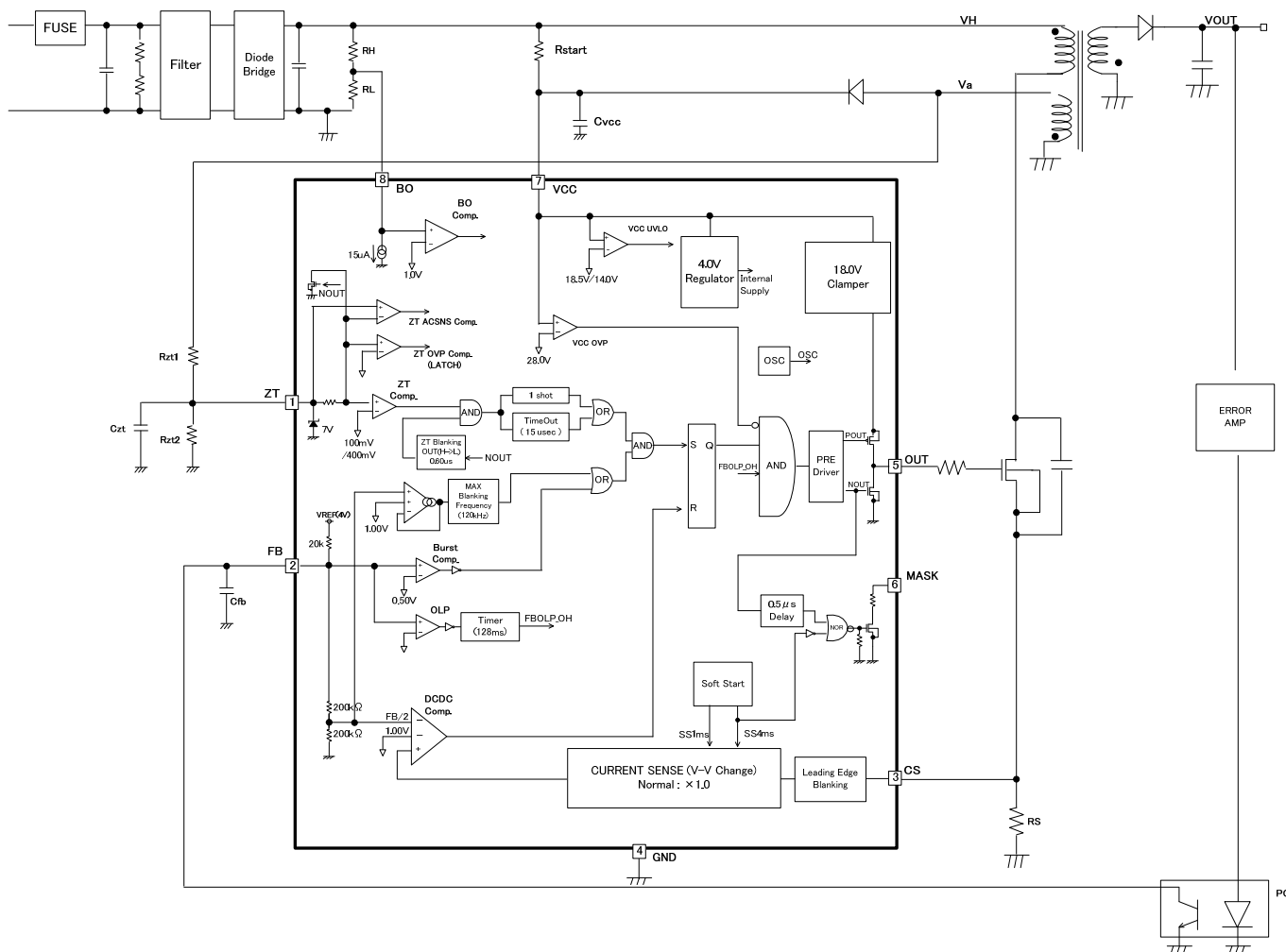

Absolute Maximum Ratings (Ta= 25 °C)

Parameter	Symbol	Rating	Unit	Conditions
Maximum Applied Voltage 1	V _{max1}	-0.3 to +32.0	V	OUT, VCC, MASK
Maximum Applied Voltage 2	V _{max2}	-0.3 to +6.5	V	ZT, CS, FB, BO
Maximum Applied Voltage 3	V _{max3}	-0.3 to +25.0	V	OUT
ZT Pin Maximum Current1	I _{SZT1}	-3.0	mA	
ZT Pin Maximum Current2	I _{SZT2}	3.0	mA	
Power Dissipation	P _d	676 (Note1)	W	
Operating Temperature Range	T _{opr}	-40 to +105	°C	
MAX Junction Temperature	T _{jmax}	150	°C	
Storage Temperature Range	T _{str}	-55 to +150	°C	

(Note1) SOP8 : When mounted (on 70 mm × 70 mm, 1.6 mm thick, glass epoxy on single-layer substrate)

De-rated by 5.4mW/°C when operating above Ta=25°C.

Caution: Operating the IC over the absolute maximum ratings may damage the IC. The damage can either be a short circuit between pins or an open circuit between pins and the internal circuitry. Therefore, it is important to consider circuit protection measures, such as adding a fuse, in case the IC is operated over the absolute maximum ratings.

Recommended Operating Conditions (Ta=25 °C)

Parameter	Symbol	Rating	Unit	Conditions
Power Supply Voltage Range	V _{CC}	15.0 to 27.5	V	VCC pin voltage

Electrical Characteristics (unless otherwise noted, Ta = 25 °C, V_{CC}= 24 V)

Parameter	Symbol	Specifications			Unit	Conditions
		MIN	TYP	MAX		
[Circuit Current]						
Circuit Current (OFF)	I _{OFF}	10	19	30	μA	V _{CC} =18.0V (VCC UVLO=Disable)
Circuit Current (ON) 1	I _{ON1}	300	800	1500	μA	FB=1.0V (at pulse operation)
Circuit Current (ON) 2	I _{ON2}	150	500	1000	μA	FB=0.0V (at burst operation)
Circuit Current (Protect circuit is on)	I _{protect}	800	1600	2200	μA	FBOLP, VCCOVP, ZTOVP
[Brown Out Block (B.O.)]						
B.O. Detection Voltage	V _{BO}	0.920	1.000	1.080	V	
B.O. Detection Hysteresis Current	I _{BO}	10	15	20	μA	
[VCC Pin Protection Functions]						
VCC UVLO Voltage 1	V _{UVLO1}	19.00	19.50	20.00	V	VCC rise
VCC UVLO Voltage 2	V _{UVLO2}	13.00	14.00	15.00	V	VCC fall
VCC UVLO Hysteresis	V _{UVLO3}	-	5.50	-	V	V _{UVLO3} = V _{UVLO1} -V _{UVLO2}
VCC OVP Voltage 1	V _{OVP1}	27.50	29.50	31.50	V	VCC rise
VCC OVP Voltage 2	V _{OVP2}	21.00	23.00	25.00	V	VCC fall
VCC OVP Hysteresis	V _{OVP3}	-	6.50	-	V	V _{OVP3} = V _{OVP1} -V _{OVP2}
Latch Release Voltage	V _{LATCH}	-	V _{UVLO2} -3.5	-	V	VCC voltage
Latch Mask Time	t _{LATCH}	50	150	250	μs	

Electrical Characteristics – continued (unless otherwise noted, Ta = 25 °C, V_{CC}=24 V)

Parameter	Symbol	Specifications			Unit	Conditions
		MIN	TYP	MAX		
[DCDC Converter Block (Turn OFF)]						
FB Pin pull-up Resistance	R _{FB}	15	20	25	kΩ	
CS Over-Current Sensor Voltage 1A	V _{LIM1A}	0.950	1.000	1.050	V	FB=2.2V (I _{ZT} >-1mA)
CS Over-Current Sensor Voltage 1B	V _{LIM1B}	0.620	0.700	0.780	V	FB=2.2V (I _{ZT} <-1mA)
CS Over-Current Sensor Voltage 2A	V _{LIM2A}	0.200	0.300	0.400	V	FB=0.6V (I _{ZT} >-1mA)
CS Over-Current Sensor Voltage 2B	V _{LIM2B}	0.140	0.210	0.280	V	FB=0.6V (I _{ZT} <-1mA)
CS Switching ZT Current	I _{ZT}	0.900	1.000	1.100	mA	
CS Leading Edge Blanking Time	t _{LEB}	-	0.250	-	μs	
Minimum ON Width	t _{MIN}	-	0.500	-	μs	
[DCDC Converter Block (Turn ON)]						
Maximum Operating Frequency 1	f _{SW1}	106	120	134	KHz	FB=2.0V
Maximum Operating Frequency 2	f _{SW2}	20	30	40	KHz	FB=0.5V
Frequency Reduction Start FB Voltage	V _{FBSW1}	1.100	1.250	1.400	V	
Frequency Reduction End FB Voltage 1	V _{FBSW2}	0.400	0.500	0.600	V	
Frequency Reduction End FB Voltage 2	V _{FBSW3}	-	0.550	-	V	
Voltage Gain	A _{VCS}	1.700	2.000	2.300	V/V	ΔV _{FB} /ΔV _{CS}
ZT Comparator Voltage 1	V _{ZT1}	60	100	140	mV	ZT fall
ZT Comparator Voltage 2	V _{ZT2}	120	200	280	mV	ZT rise
ZT Trigger Mask Time	t _{ZTMASK}	0.25	0.60	0.95	μs	For noise prevention after OUT H ⇒L
ZT Trigger Timeout Period 1	t _{ZTOUT1}	8.0	15.0	24.0	μs	Count from final ZT trigger (1-stage)
ZT Trigger Timeout Period 2	t _{ZTOUT2}	2.0	5.0	8.0	μs	Count from final ZT trigger (2-stage)
Maximum ON Time	t _{ZTON}	27.0	45.0	62.0	μs	
[DCDC Protection Functions]						
Soft Start Time 1	t _{SS1}	0.600	1.000	1.400	ms	
Soft Start Time 2	t _{SS2}	2.400	4.000	5.600	ms	
FB OLP Voltage 1	V _{FOLP1}	2.500	2.800	3.100	V	FB rise
FB OLP Voltage 2	V _{FOLP2}	2.300	2.600	2.900	V	FB fall
FB OLP Timer	t _{FOLP}	90	128	166	ms	
ZT OVP Voltage	V _{ZTL}	3.250	3.500	3.750	V	
[OUT Pin]						
OUT Pin Clamp Voltage	V _{OUT}	16.00	18.00	20.00	V	
OUT pin Nch MOS Ron	R _{NOUT}	2.0	4.5	9.0	Ω	
[MASK Pin]						
MASK Pin Delay Time	t _{MASK}	0.25	0.60	0.95	μs	
MASK Pin Ron	R _{MASK}	20	50	80	Ω	

Application Information

Description of Blocks

- (1) Start-Up sequences (FBOLP:auto recovery mode)
 The BD768xFJ's start up sequence is shown in Figure 1.
 See the sections below for detailed descriptions.

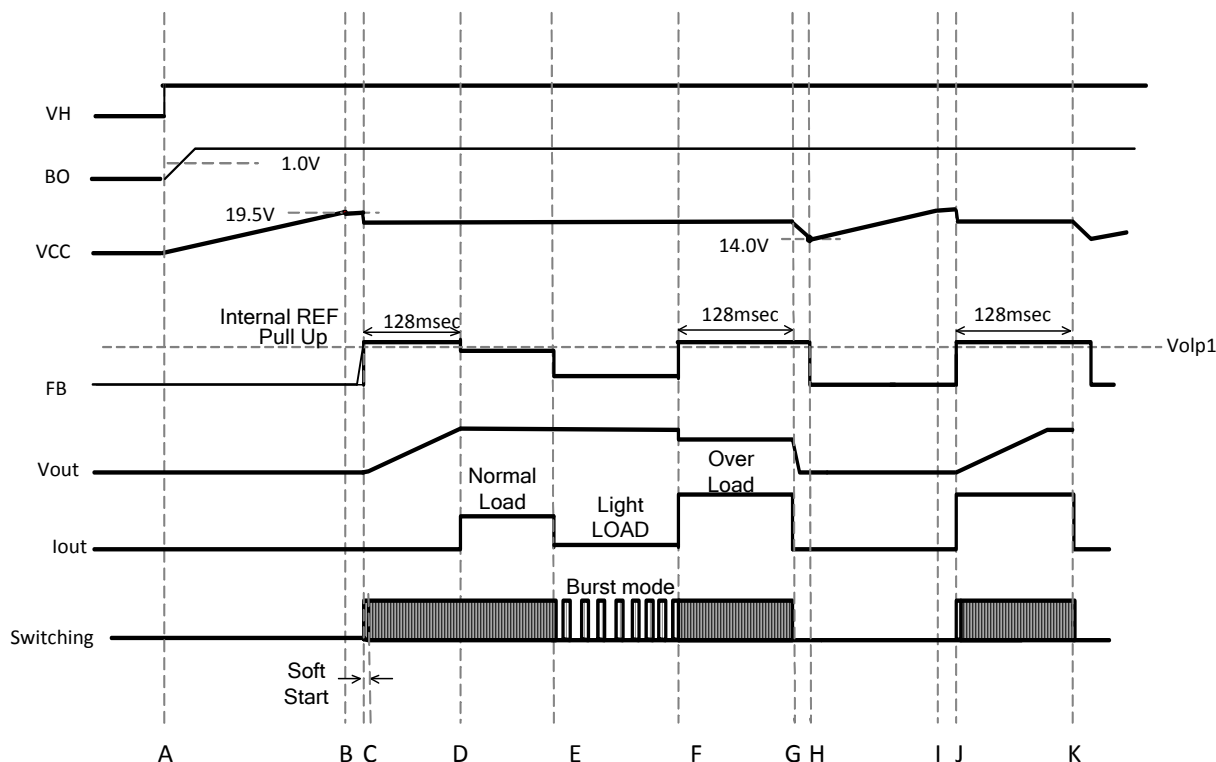

Figure 1. Start-up Sequence Timing Chart

- A: Input voltage V_H is applied
- B: V_{CC} pin voltage rises due to start resistor R_{START} , and this IC starts operating when $V_{CC} > V_{UVLO1}$ (19.5V typ).
 Switching starts when the status of the brown out function is normal ($BO > 1.0V$), other protection functions are also considered normal. At that time, the V_{CC} value always drops due to the pin's consumption current, so $V_{CC} > V_{UVLO2}$ (14.0V typ) should be set.
- C: There is a soft start function which regulates the voltage level at the CS pin to prevent a rise in voltage and current.
- D: When the switching operation starts, V_{OUT} rises.
 Once the output voltage starts, set the rated voltage to within the T_{FOLP} period (128ms typ).
- E: When there is a light load, burst operation is order to keep power consumption down.
- F: Overload operation.
- G: When the FB pin voltage keeps $FB > V_{FOLP1}$ ($=2.8V$ typ) at or above T_{FOLP} (128ms typ), switching is stopped by the overload protection circuit.
 If the FB pin voltage status becomes $FB < V_{FOLP1B}$ even once, the IC's internal 128ms timer is reset.
- H: If the V_{CC} voltage drops to $V_{CC} < V_{UVLO2}$ (14.0V typ) or below, restart is executed.
- I: The IC's circuit current is reduced and the V_{CC} pin value rises. (Same as B)
- J: Same as F
- K: Same as G

Start resistance R_{START} is the resistance required to start the IC.
 When the start resistance R_{START} value is reduced, standby power is increased and the startup time is shortened.
 Conversely, when the start resistance R_{START} value is increased, standby power is reduced and the startup time is lengthened.
 When BD768xFJ is in standby mode, current I_{OFF} becomes 30 μ A Max
 However, this is the minimum current required to start the IC. Use the appropriate current for the set target.

Example: Start Resistance R_{START} Setting

$R_{START} = (V_{MIN} - V_{UVLO(max)}) / I_{OFF}$
 When $V_{AC} = 100V$, if the margin is -20%, then $V_{MIN} = 113V$
 Since $V_{UVLO1(max)} = 20.0V$,
 And since $R_{START} < (113-20) / 30\mu A = 3.10M\Omega$, the start resistance is 3.0M Ω . (Set according to the start time.)
 In this case: R_{START} power consumption $Pd(R_{START}) = (V_H - V_{CC})^2 / R_{START} = (141V - 14V)^2 / 3.0M = 5.4mW$

(2) Brown Out function (B.O.)

BD768xFJ has a built-in brown out function. When the input V_H value is low, the brown out function stops the DC/DC operations (The IC itself continues to operate). An example is shown in Figure 2. The input voltage which is resistance-divided is inputted to the BO pin. If the BO pin value exceeds V_{BO} (1.0 V typ), the circuit detects as normal state, and DCDC operations are started. There is a current hysteresis I_{BO} in the circuit.

The current hysteresis flow is described below.

- BO < V_{BO} (1.0 V typ) (abnormal) I_{BO} with sync
- BO ≥ V_{BO} (1.0 V typ) (normal status) I_{BO} without sync

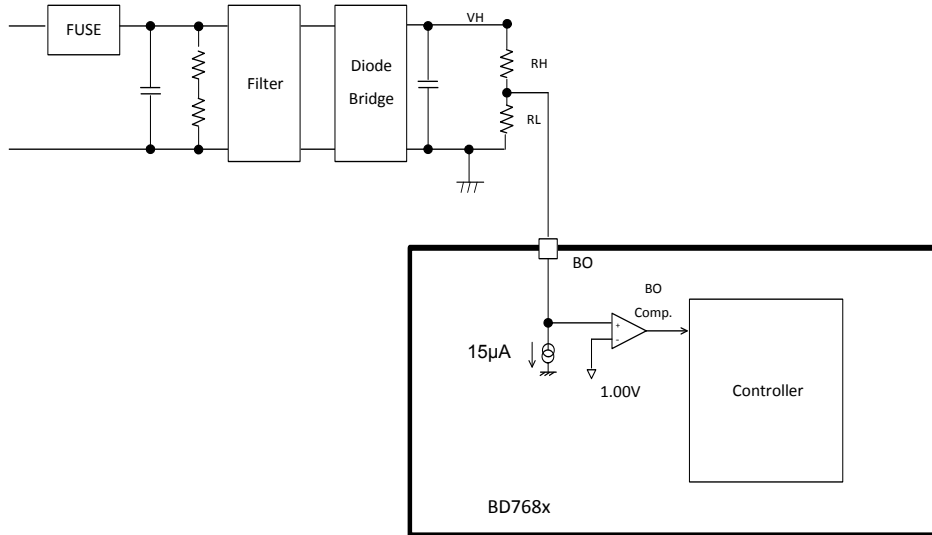

Figure 2. Block Diagram of Brown Out Function

Example: R_H and R_L Setting

In the following example, V_{HON} is the operation start V_H voltage (L to H), and V_{HOFF} is the operation stop V_H voltage (H to L).

IC operation start (OFF => ON) $(V_{HON}-1.0) / R_H = 1.0/R_L + 15 \cdot 10e-6$
 IC operation stop (ON => OFF) $(V_{HOFF}-1.0) / R_H = 1.0/R_L$

Based on the above, R_H and R_L can be calculated as follows.
 $R_H = (V_{HON} - V_{HOFF}) / (15 \cdot 10e-6)$, $R_L = 1.0 / (V_{HOFF} - 1.0) \cdot R_H$

Example 1: When using 100 V AC (140 V DC)

When R_H = 2350kΩ and R_L = 34kΩ, V_{HON} = 105.8V (-25%) and V_{HOFF} = 70.8V (-51%)
 Current consumption is 8.0mW for both R_H and R_L.

Example 2: When using 230V AC (322V DC)

R_H = 5200kΩ, R_L = 42kΩ
 V_{HON} = 202.8V (-37%), V_{HOFF} = 124.8V (-62%)

Current consumption is 20.1 mW for both R_H and R_L.

(3) VCC Pin Protection Function

BD768xFJ includes the VCC low voltage protection function VCC UVLO (Under Voltage Protection) and the VCC over voltage protection function VCC OVP (Over Voltage Protection). These functions prevent abnormal voltage-related damage in MOSFETs used for switching.

The VCC UVLO function uses an auto recovery type comparator with voltage hysteresis and the VCC OVP function uses latch mode or auto recovery.

After latch function is detected by VCCOVP, latching is released (reset) when the condition $V_{CC} < V_{LATCH}$ (typ = $V_{UVLO2} - 3.5V$) is met.

This operation is shown in Figure 3.

VCCOVP has a built-in mask time T_{LATCH} (typ = 150 μs).

This function masks any surges, etc., that occur at the pin.

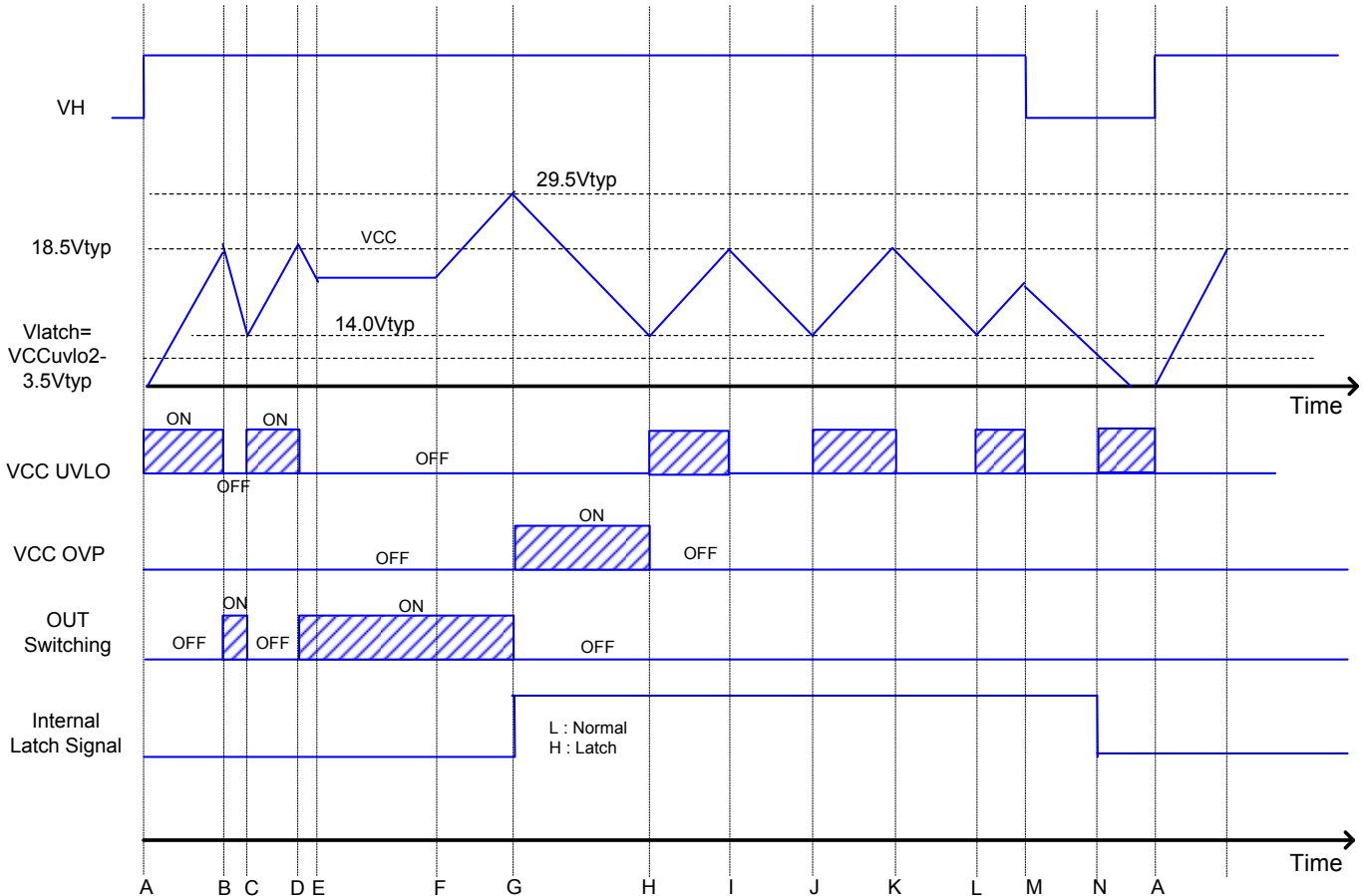

Figure 3. VCC UVLO / OVP (Latch Mode)

A: V_H is applied, VCC voltage rises

B: When $V_{CC} > V_{UVLO1}$, DC/DC operation starts.

C: When $V_{CC} < V_{UVLO2}$, DC/DC operation stops.

D: When $V_{CC} > V_{UVLO1}$, DC/DC operation starts.

E: VCC voltage drops until DC/DC operation starts.

F: VCC rises.

F: When $V_{CC} > V_{OVP1}$, DC/DC operation stops (latch mode). Switching is stopped by an internal latch signal.

G: When DC/DC operation stops, power supply from the auxiliary coil stops and VCC voltage drops.

H: When $V_{CC} < V_{UVLO2}$, VCC voltage rises because IC current consumption drops.

I: When $V_{CC} > V_{UVLO1}$, latching occurs and so there are no DC/DC operations. VCC voltage drops because IC current consumption is lowered.

K: Same as H

L: Same as I

M: V_H is OPEN (unplugged). VCC drops.

N: When $V_{CC} < V_{LATCH}$, latch is released.

(4) DCDC Converter Function

BD768xFJ uses PFM (Pulse Frequency Modulation) mode control.

The FB pin, ZT pin, and CS pin are all monitored to provide a system optimized for DC/DC.

The switching MOSFET ON width (turn OFF) is controlled via the FB pin and CS pin, and the OFF width (turn ON) is controlled via the ZT pin.

PFM mode sets the maximum frequency to meet noise standards.

A detailed description appears below. (See Figure 4)

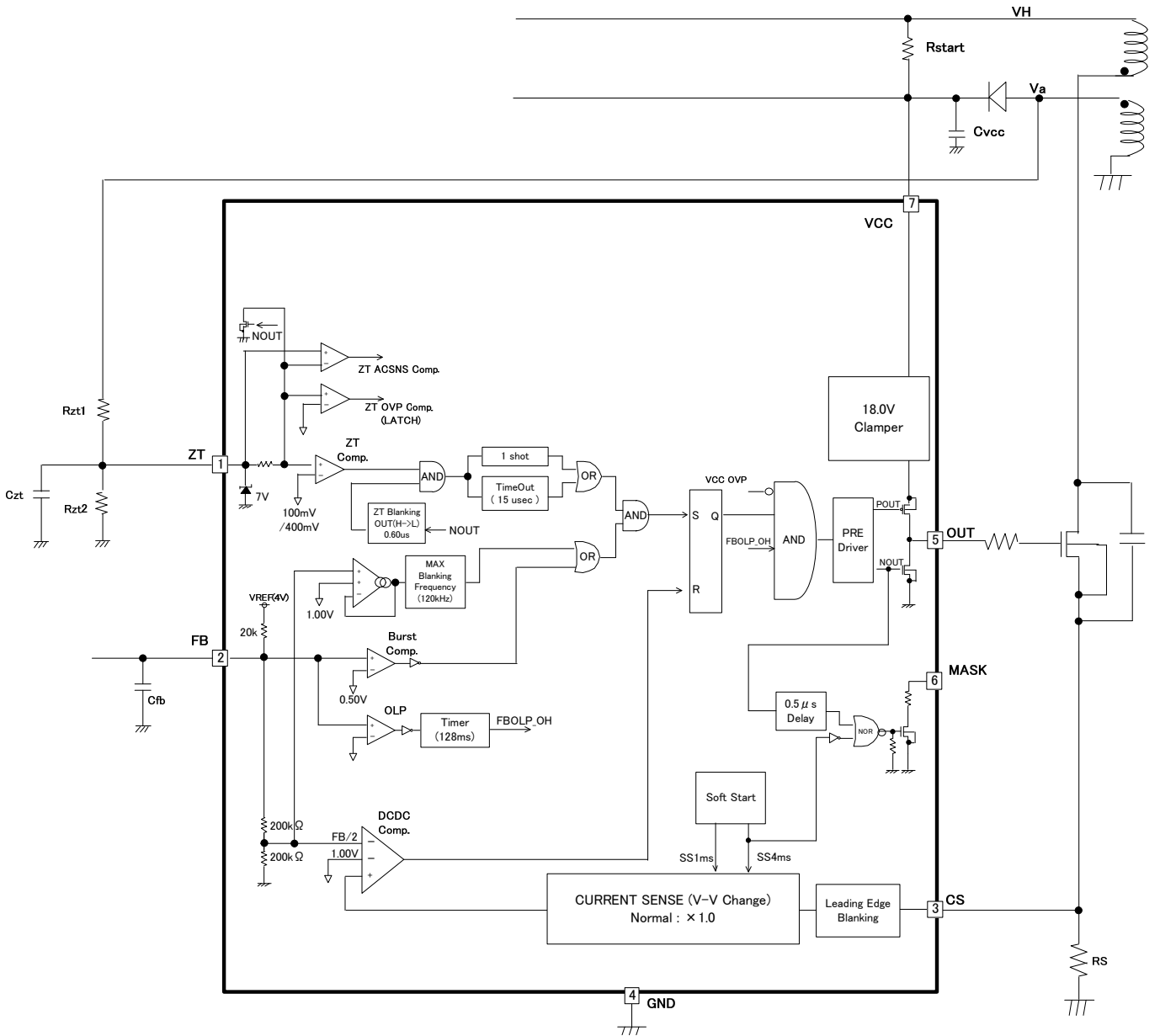

Figure 4. Block Diagram of DC/DC Operations

(a) Determination of ON Width (Turn OFF)

ON width is controlled via the FB pin and CS pin.

The ON width is determined by comparing FB pin voltage at $1/AV_{CS}$ (typ = 1/2) with the CS pin voltage.

In addition, it is compared with the IC's internally generated V_{LIM1} (1.0V typ) voltage and the comparator level changes linearly, as is shown in Figure 5.

The CS pin is also used for the per-pulse over-current limiter circuit.

Changes at the FB pin result in changes in the maximum blanking frequency and over-current limiter level.

- mode1: Burst operation
- mode2: Frequency reduction operation (reduces maximum frequency)
- mode3: Maximum frequency operation (operates at maximum frequency)
- mode4: Overload operation (pulse operation is stopped when overload is detected)

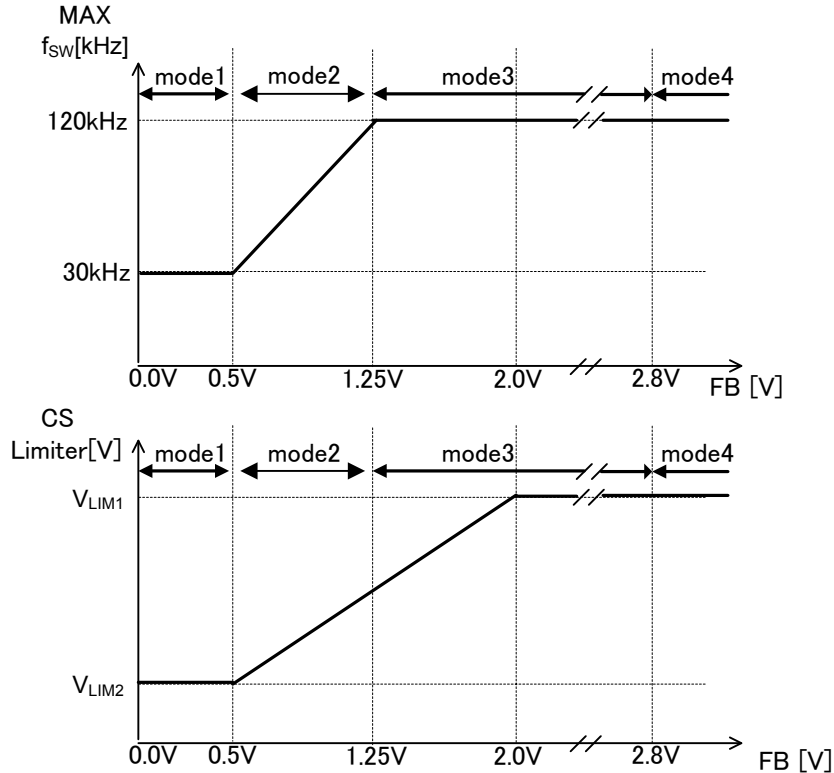

Figure 5. Relationship of FB Pin to Over-Current Limiter and Maximum Frequency

The over-current limiter level is adjusted for soft start function (section 5) and over-current protection of the input voltage compensation (section 4 (c))

In this case, the V_{LIM1} and V_{LIM2} values are as listed below.

Table 1 Over-Current Protection Voltage

Soft Start	$I_{ZT} \geq -1.0mA$		$I_{ZT} < -1.0mA$	
	V_{LIM1}	V_{LIM2}	V_{LIM1}	V_{LIM2}
Start to 1ms	0.250V (25.0%)	0.063V (6.0%)	0.175V (17.5%)	0.047V (4.5%)
1ms to 4ms	0.500V (50.0%)	0.125V (12.0%)	0.350V (35.0%)	0.094V (9.0%)
>4ms	1.000V (100.0%)	0.250V (25.0%)	0.700V (70.0%)	0.188V (18.8%)

(Note) Values in parentheses are relative values when compared to V_{LIM1} (1.0V typ) during $I_{ZT} \geq -1.0mA$.

(b) LEB (Leading Edge Blanking) Function

When the switching MOSFET is turned ON, surge current occur at each capacitor component and drive current. Therefore, when the CS pin voltage rises temporarily, detection errors may occur in the over-current limiter circuit.

To prevent detection errors, BD768xFJ has the blanking function. This function masks the CS voltage for T_{LEB} (typ = 250ns) after the OUT pin changes from low to high.

This blanking function reduces CS pin filter.

(c) CS Over-Current Protection Switching Function

When the input voltage (VH) becomes high, the ON time is shortened and the operating frequency increases. As a result, the maximum rated power is increased for a certain over-current limiter. As a countermeasure, switching is performed by the IC's internal over-current protection function.

When at high voltage, the over-current comparator value which determines the ON time is always multiplied by 0.7.

Detection is performed by monitoring the ZT inflow current and then switching.

When the MOSFET is turned ON, Va becomes a negative voltage dependent upon the input voltage (VH). The ZT pin is clamped to nearly 0V in the IC.

The formula used to calculate this is shown below. A block diagram is shown in Figure 6. Also, graphs are shown in Figure 7, Figure 8 and Figure 9.

$$I_{ZT} = (V_a - V_{ZT}) / R_{ZT1} = V_a / R_{ZT1} = V_H * N_a / N_p / R_{ZT1}$$

$$R_{ZT1} = V_a / I_{ZT}$$

Therefore, the VH voltage is set with a resistance value (R_{ZTL}). The ZT bottom detection voltage has now been determined, so C_{ZT} should be used to set the timing.

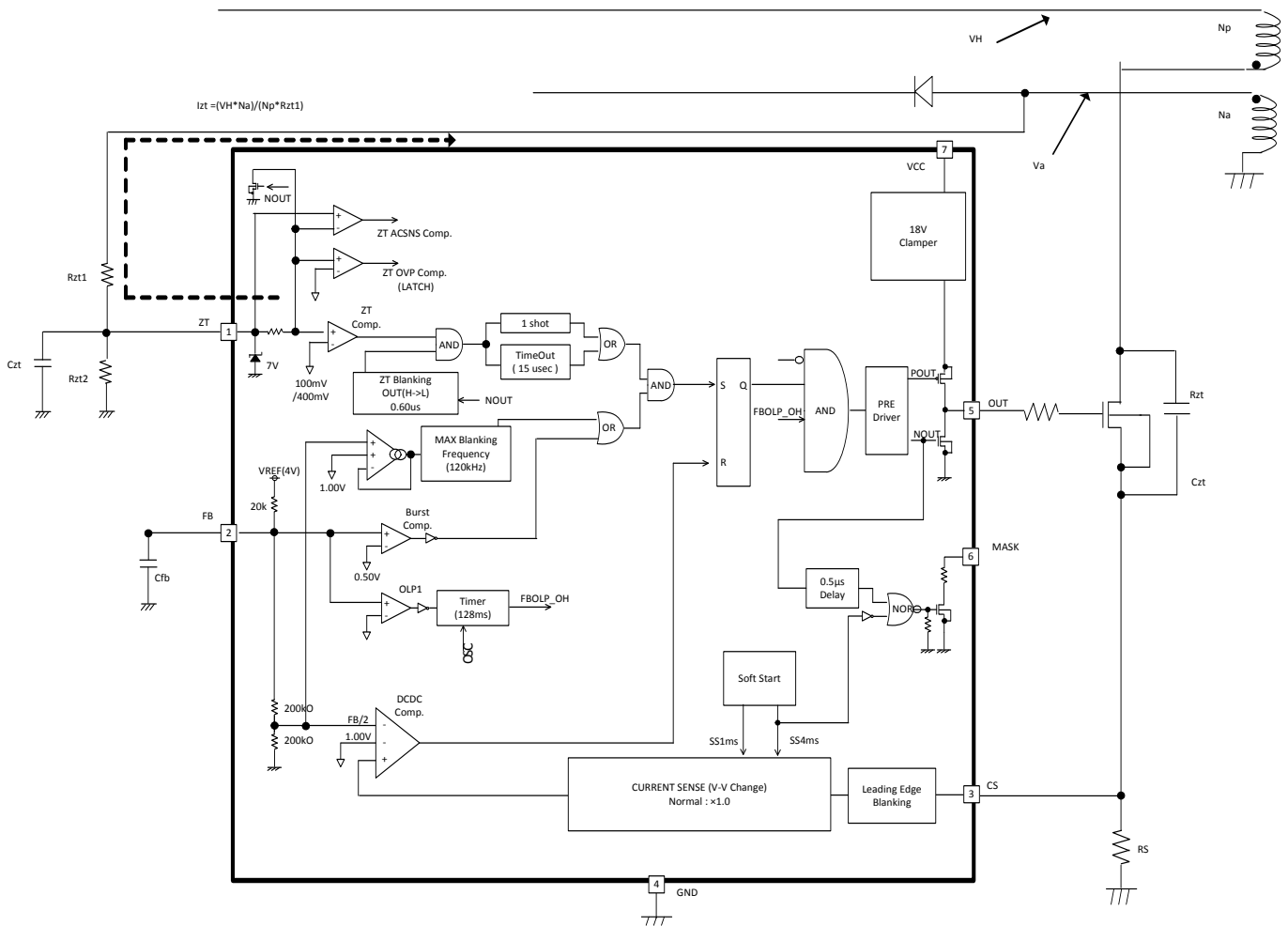

Figure 6. Block Diagram of CS Switching Current

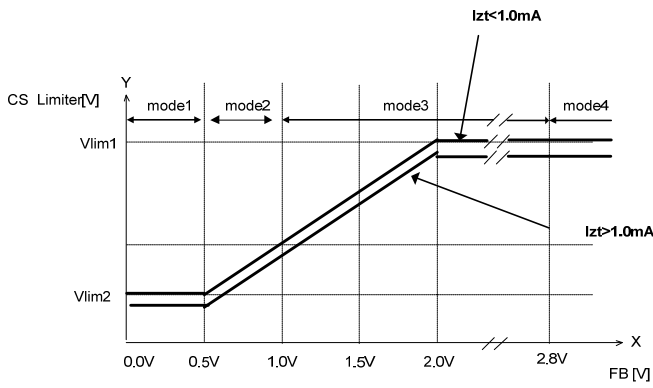

Figure 7. CS Switching: FB Voltage vs CS Voltage

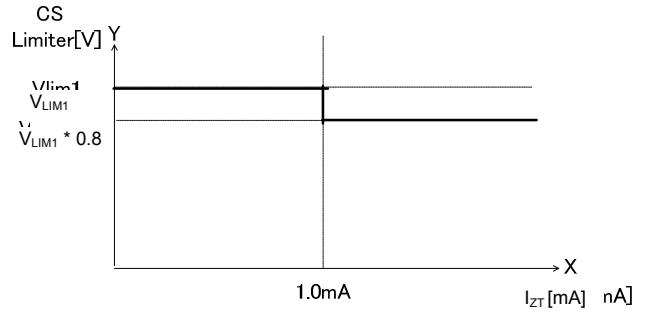

Figure 8. CS Switching: ZT Current vs CS Voltage

Example: Setup method (for switching between 100-V AC and 220-V AC.)

100-V AC: 141V ±42V (±30% margin)

220-V AC: 308V ±62V (±20% margin)

In the above cases, the CS current is switched in the range from 182V to 246V. This is done when => VH = 214 VH.

Given: Np = 100, Na = 15.

$$V_a = V_{in} * N_a / N_p = 214V * 15 / 100 * (-1) = -32.1V$$

$$R_{ZC} = V_a / I_{ZT} = -32.1V / -1mA = 32.1k\Omega$$

According to the above, R_{ZT} = 32 KΩ is set.

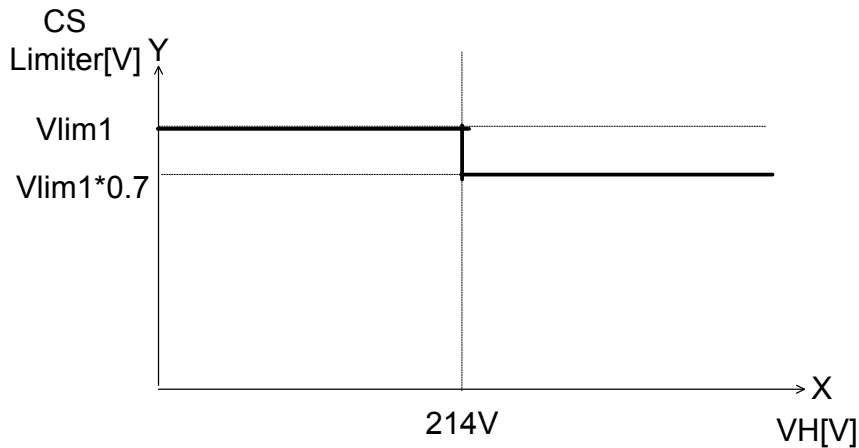

Figure 9. CS Switching: VH Voltage vs CS Voltage

(d) Determination of OFF Width (Turn ON)

OFF width is controlled at the ZT pin.

When switching is OFF, the power stored in the coil is supplied to the secondary-side output capacitor.

When this power supply ends, there is no more current flowing to the secondary side, so the switching MOS drain pin voltage drops.

Consequently, the voltage on the auxiliary coil side also drops.

A voltage that was resistance-divided from the ZT pin by R_{ZT1} and R_{ZT2} is applied. When this voltage level drops to V_{ZT1} (100 mV typ) or below, switching is turned ON by the ZT comparator. Since zero current status is detected at the ZT pin, time constants are generated using C_{ZT} , R_{ZT1} , and R_{ZT2} .

Additionally, a ZT trigger mask function (described in section 4 (e)) and a ZT timeout function (described in section 4 (f)) are built in.

(e) ZT Trigger Mask Function (Figure 10)

When switching is set ON / OFF, superposition of noise may occur at the ZT pin.

At this time, the ZT comparator is masked for the T_{ZTMASK} time to prevent ZT comparator operation errors.

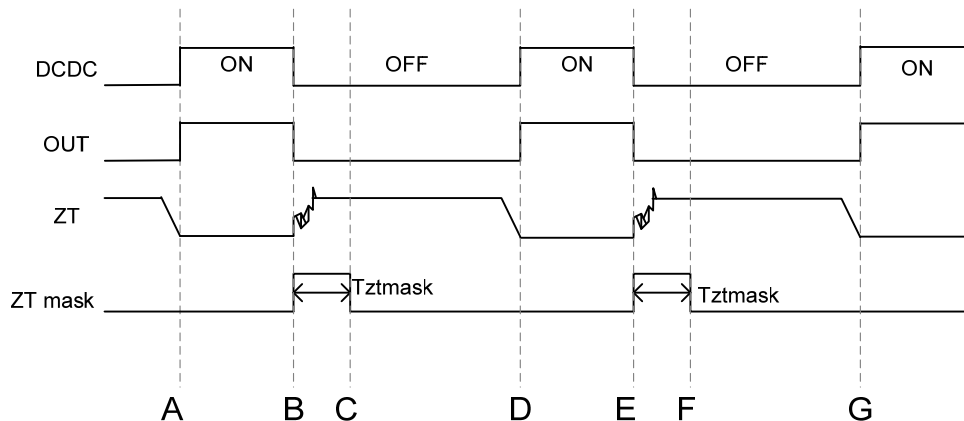

Figure 10. ZT Trigger Mask Function

A: DC/DC OFF=>ON

B: DC/DC ON=>OFF

C: Noise occurs at ZT pin, and ZT comparator is not operated by T_{ZTMASK} .

D: Same as A

E: Same as B

F: Same as C

G: Same as A

- (f) ZT Timeout Function
 - ZT Timeout Function1
When ZT pin voltage is not higher than V_{ZT2} (typ=200mV) for t_{ZTOUT1} (typ=15 μ s) such as start or low output voltage, ZT pin short, IC turns on MOSFET by force.
 - ZT Timeout Function 2
After ZT comparator detects bottom, IC turns on MOSFET by force when IC does not detect next bottom within t_{ZTOUT2} (typ =5 μ s). After ZT comparator detects bottom at once, the function operates. For that, it does not operate at start or at low output voltage. When IC is not able to detect bottom by decreasing auxiliary winding voltage, the function operates.

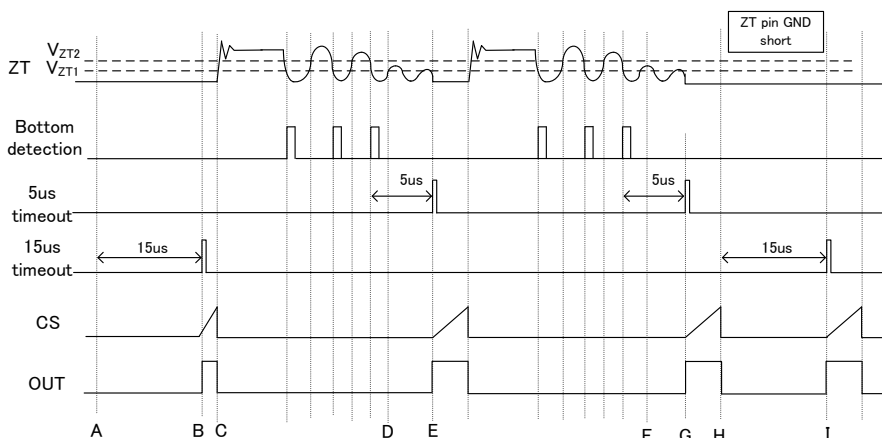

Figure 11. ZT Time-out Function

- A: At starting, IC starts to operate by ZT timeout function1 for ZT=0V.
- B: MOSFET turns ON
- C: MOSFET turns OFF
- D: ZT voltage is lower than V_{ZT2} (typ=200mV) by ZT dump decreasing.
- E: MOSFET turns ON by ZT timeout fucntion2 after t_{ZT2} (typ=5 μ s) from D point.
- F: ZT voltage is lower than V_{ZT2} (typ=200mV) by ZT dump decreasing.
- G: MOSFET turns ON by ZT timeout fucntion2 after t_{ZT2} (typ=5 μ s) from F point.
- H: ZT pin is short to GND.
- I: MOSFET turns ON by ZT timeout function1 after t_{ZTOUT1} (typ=15 μ s)

(5) Soft Start Operations

Normally, a large current starts flowing to the AC/DC power supply when the AC power supply is turned ON. BD768xFJ includes a soft start function to prevent large changes in the output voltage and output current during startup.

This function is reset when the VCC pin voltage is at V_{UVLO2} (7.5V typ) or below, or when the BO pin is at the B.O. detection voltage (1.00V typ) or below (that is, when the AC power supply is unplugged), and soft start is performed again at the next AC power-ON.

During a soft start, the following post-startup operations are performed. (See turn OFF described above in section 4 (a)).

- Start to 1ms => Set to 25% of normal CS limiter value
- 1ms to 4ms => Set to 50% of normal CS limiter value
- > 4 ms... => Normal operation

(6) Over Load Protection Function

The overload protection function monitors the overload status of the secondary output current at the FB pin, and fixes the OUT pin at low level when overload status is detected.

During overload status, current no longer flows to the photo-coupler, so the FB pin voltage rises.

When this status continues for the T_{FOLP} time (128ms typ), it is considered an overload and the OUT pin is fixed at low level.

Once the FB pin voltage exceeds V_{FOLP1} (2.8V typ), if it drops to lower than V_{FOLP2} (2.6V typ) within the T_{FOLP} time (128ms typ), the overload protection timer is reset.

At startup, the FB voltage is pulled up to the internal voltage by a pull-up resistor and operation starts once the voltage reaches V_{FOLP1} (2.8V typ) or above. Therefore, the design must be set the FB voltage at V_{FOLP2} (2.6V typ) or below within the t_{FOLP} (128ms typ) time.

In other words, the secondary output voltage start time must be set to within T_{FOLP} (128ms typ) after IC startup.

To release latching after selecting latch mode, first unplug the power supply, and then set $V_{CC} < V_{LATCH}$ (typ= V_{UVLO2} -3.5V)

(7) ZT Pin OVP (Over Voltage Protection)

ZT OVP (Over Voltage Protection) function is built in for ZT pin.

When the ZT pin voltage reaches V_{ZTL} (typ = 3.5V), overvoltage status is detected. ZT pin OVP protection is performed in latch mode.

A mask time defined as T_{LATCH} (typ = 150 μ s) is built in for the ZT pin OVP function. When ZT OVP status continues within 150 μ s, overvoltage is detected. This function masks any surges (etc.) that occur at the pin. See the illustration in Figure 12.

(A similar T_{LATCH} (typ = 150 μ s) is V_{CCOVP})

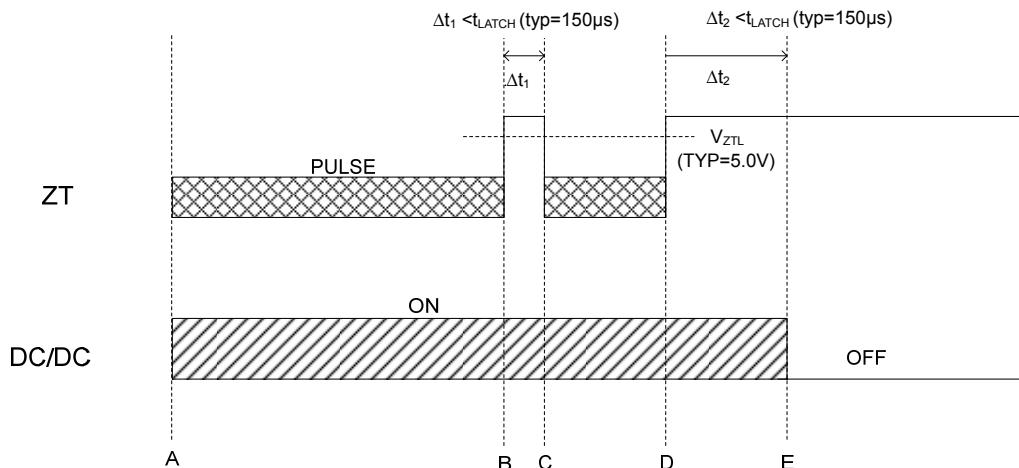

Figure 12. ZTOVP and Latch Mask Function

A: DC/DC pulse operation, ZT pin also has pulse operation

B: ZT pin voltage > V_{ZTL} (typ = 3.5V)

C: ZT pin voltage > V_{ZTL} (typ = 3.5V) status is within t_{LATCH} (typ = 150 μ s) period, so DC/DC normal operations are reset

D: ZT pin voltage > V_{ZTL} (typ = 3.5V)

E: ZT pin voltage > V_{ZTL} (typ = 3.5V) status continues for t_{LATCH} (typ = 150 μ s), so latching occurs and DC/DC OFF is set

(8) MASK Pin Function

The MASK pin is used for control that maintains constant voltage at the BD768xFJ's power supply pin (VCC pin). Figure 13 shows an application diagram using the MASK signal.

At the timing of DC/DC ON => OFF switching, a surge voltage in the auxiliary coil makes V_a pin voltage rise. This also causes the VCC pin voltage to rise. The MASK pin outputs a signal that has been delayed by the time T_{MASK} relative to the OUT pin. (See Figure 14)

The MASK pin is an open drain output, and an external transistor is used for ON/OFF control. This function is able to maintain a constant VCC pin voltage.

During a soft start, the MASK pin is fixed at Hiz level. Consequently, the external transistor status is ON. (See Figure 13)

Leave open when not using the MASK pin.

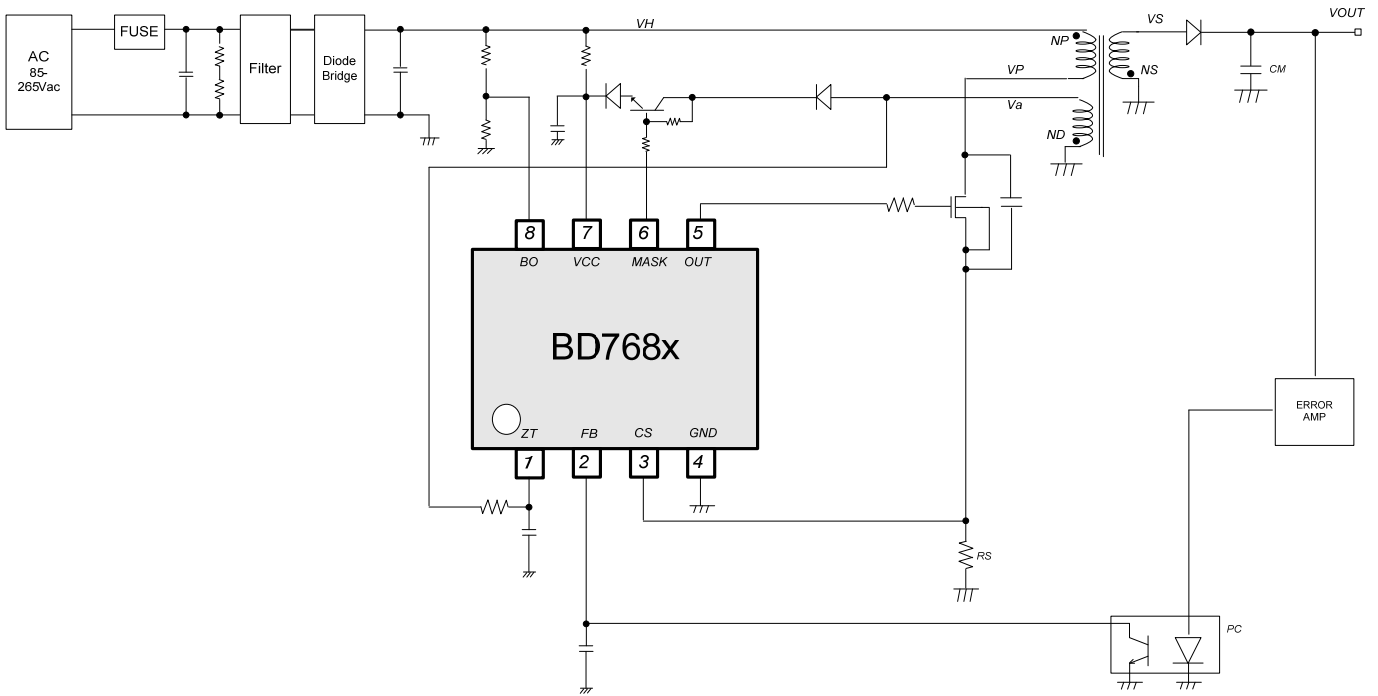

Figure 13. Application Circuit Example Using MASK Pin

(Note) In case of low output power, it isn't much power from the aux. window to VCC pin. Please adjust a set value.

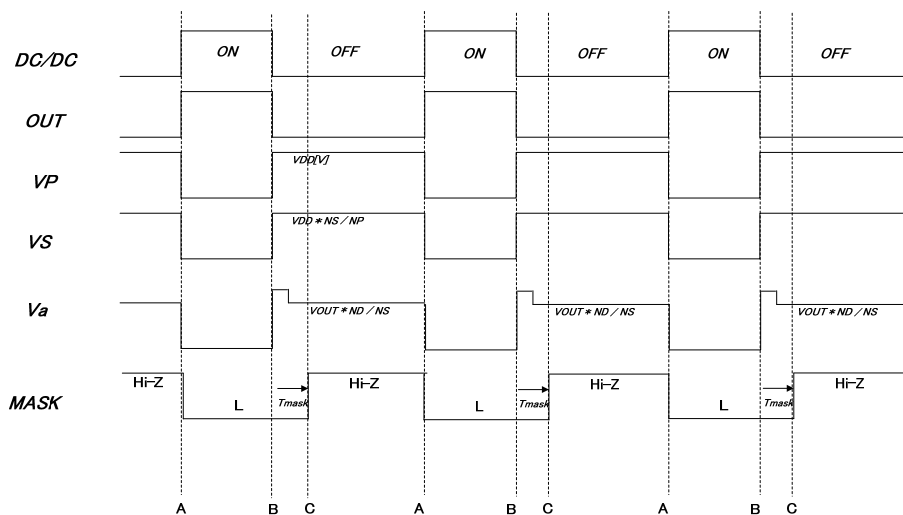

Figure 14. MASK Pin Timing Chart (Normal Operation)

- A : DC/DC OFF=>ON
- B : DC/DC ON=>OFF
- C : During T_{mask} time, MASK pin is L

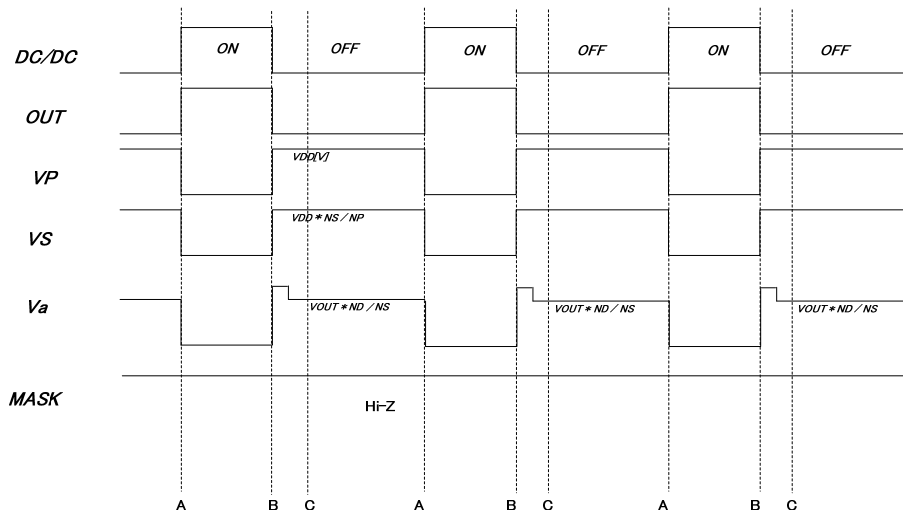

Figure 15. MASK Pin Timing Chart (Soft Start Operation)

- A : DC/DC OFF => ON
- B : DC/DC ON => OFF
- C : MASK pin is fixed at Hiz level.

(9) OUT Pin Gate Clamp Circuit

OUT pin is connected to external MOSFET's gates.
 For MOSFET's gates is safety, OUT voltage is clamped to Gate Clamp circuit.

(10) Thermal Shut-Down Function

Thermal Shut-Down function is auto restart type. When VCC UVLO is released, BD768xFJ starts on State2 because of preventing from thermal error of external parts. At start up, it does not start until T1 below.

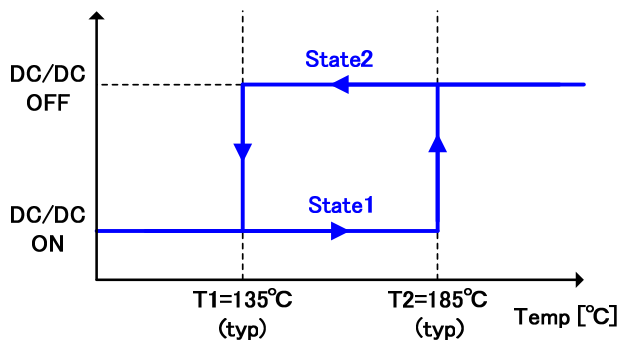

Figure 16. Thermal Shut-Down

Protection Circuit Operation Modes

Table 2 below lists the operation modes of the various protection functions.

Table 2 Protection Circuit Operation Modes

Item	Operation Mode
Brown Out Protection	Auto recovery
VCC Under Voltage Locked Out	Auto recovery
VCC Over Voltage Protection	BD7682/7684 = Auto recovery BD7683/7685 = Latch
FB Over Limited Protection	BD7682/7683 = Auto recovery BD7684/7685 = Latch
ZT Over Voltage Protection	Latch

Power Dissipation

The thermal design should be set operation for the following conditions.
(Since the temperature shown below is the guaranteed temperature, be sure to take a margin into account.)

- 1. The ambient temperature T_a must be 105°C or less.
- 2. The IC's loss must be within the allowable dissipation P_d .

The thermal dissipation characteristics are as follows.
(PCB: 70 mm × 70mm × 1.6 mm, mounted on glass epoxy substrate)

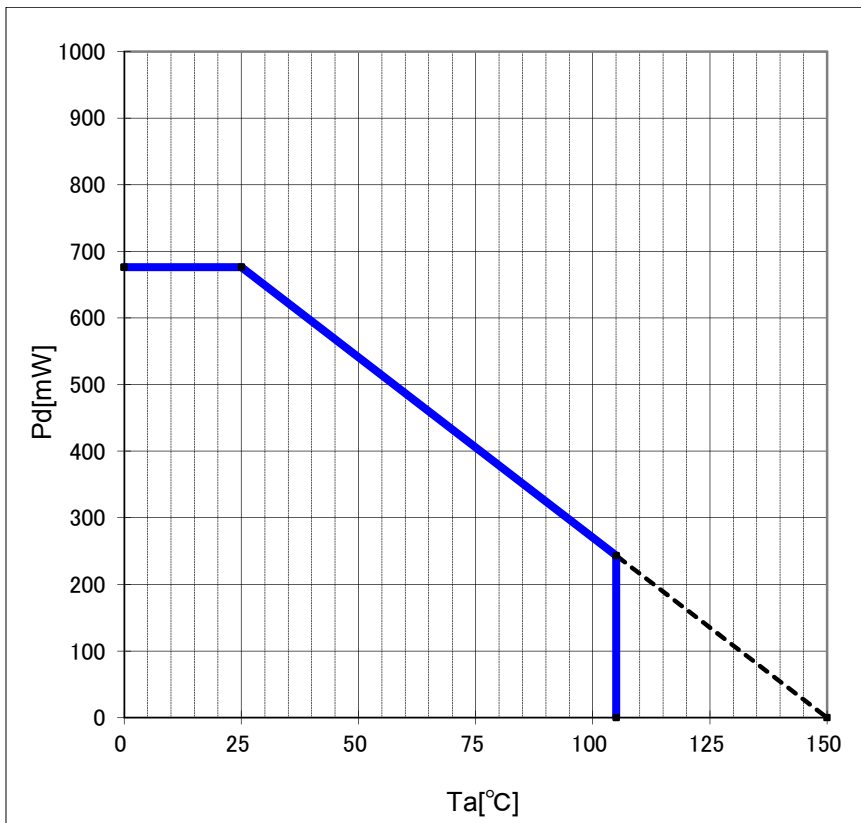
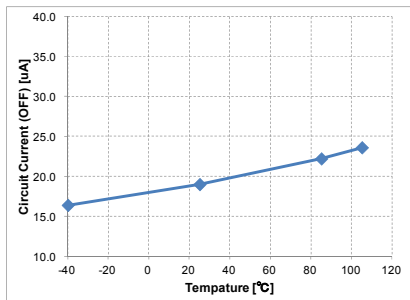

Figure 17. SOP-J8 Thermal De-rating Curve

I/O Equivalent Circuit

1	ZT	2	FB	3	CS	4	GND
5	OUT	6	MASK	7	VCC	8	BO

●Characteristic Data (They are only reference data)



Circuit Current (OFF)

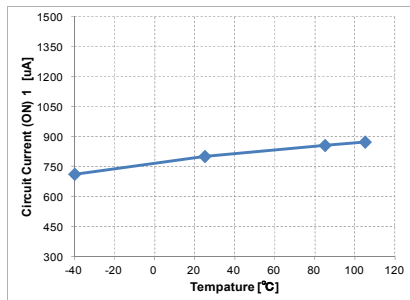

Circuit Current (ON) 1

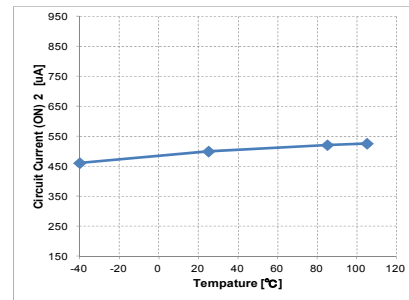

Circuit Current (ON) 2

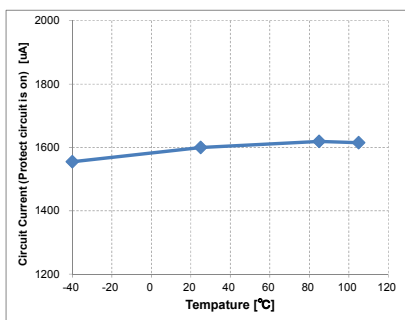

Circuit Current (Protect circuit is on)

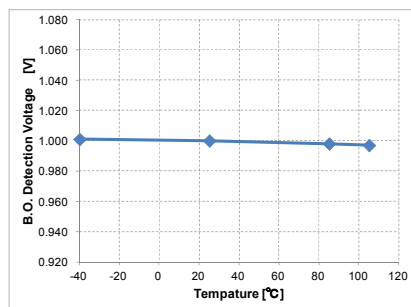

B.O. Detection Voltage

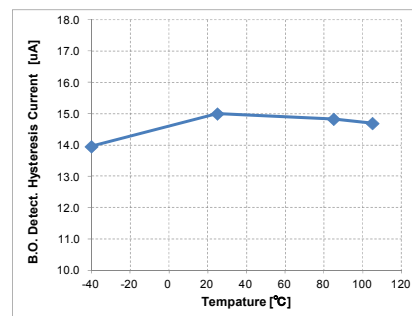

B.O. Detection Hysteresis Current

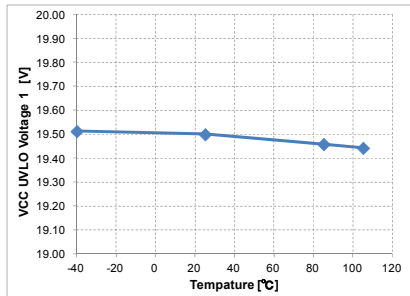

VCC UVLO Voltage 1

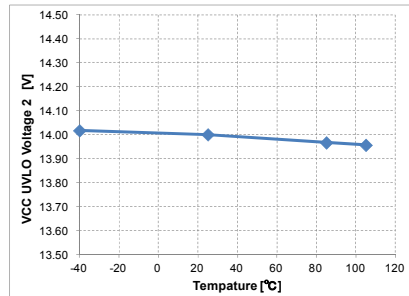

VCC UVLO Voltage 2

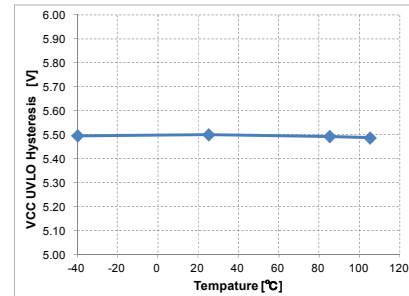

VCC UVLO Hysteresis

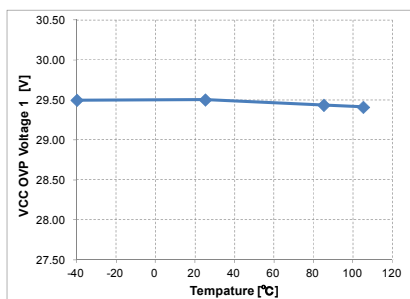

VCC OVP Voltage 1

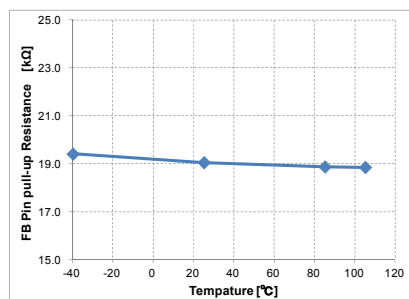

FB Pin pull-up Resistance

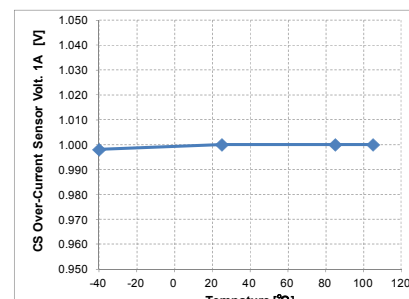

CS Over-Current Sensor Voltage 1A

●Characteristic Data (They are only reference data)

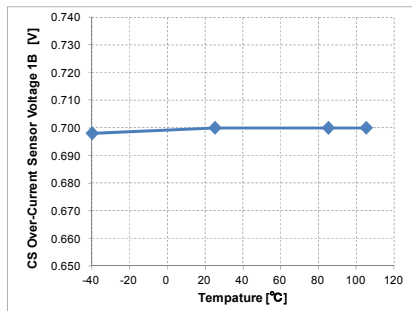

CS Over-Current Sensor Voltage 1B

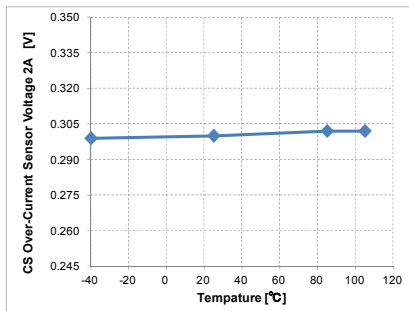

CS Over-Current Sensor Voltage 2A

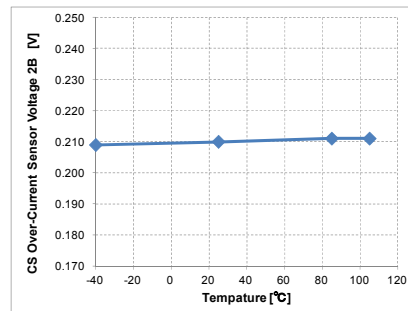

CS Over-Current Sensor Voltage 2B

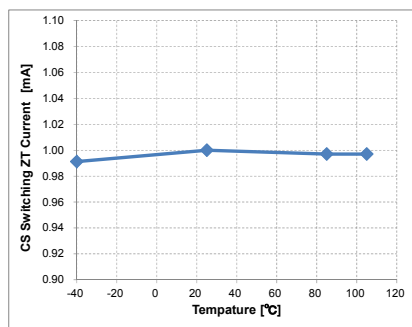

CS Switching ZT Current

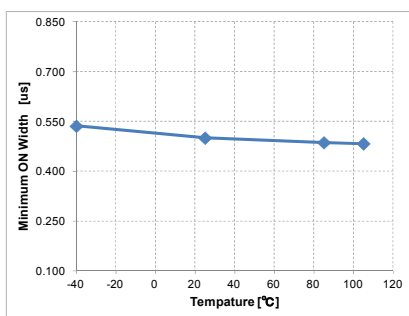

Minimum ON Width

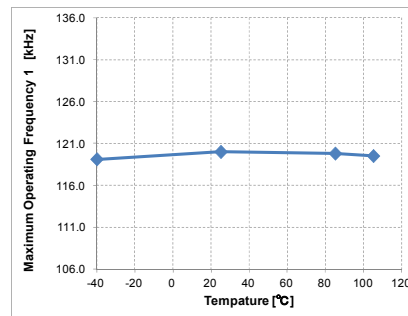

Maximum Operating Frequency 1

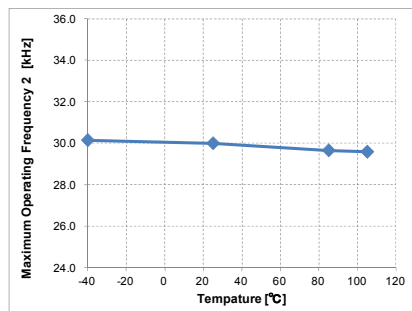

Maximum Operating Frequency 2

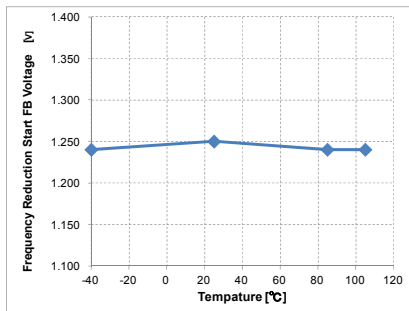

Frequency Reduction Start FB Voltage

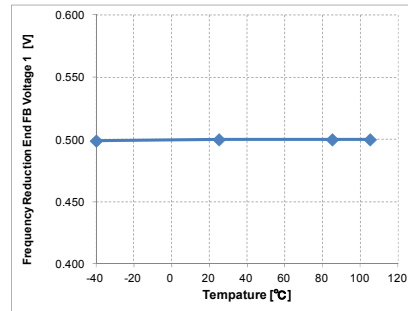

Frequency Reduction End FB Voltage 1

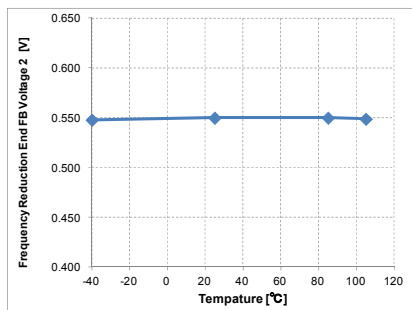

Frequency Reduction End FB Voltage 2

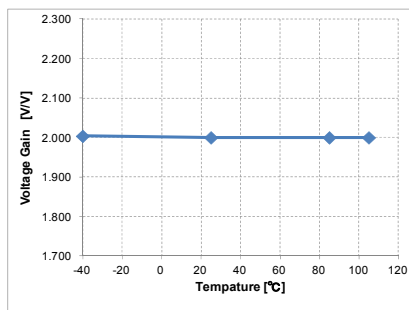

Voltage Gain

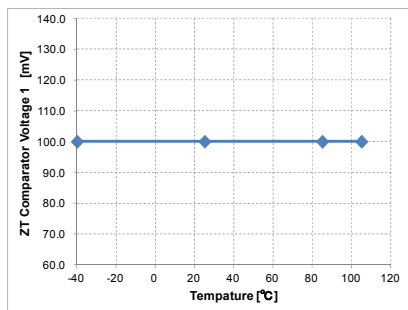

ZT Comparator Voltage 1

●Characteristic Data (They are only reference data)

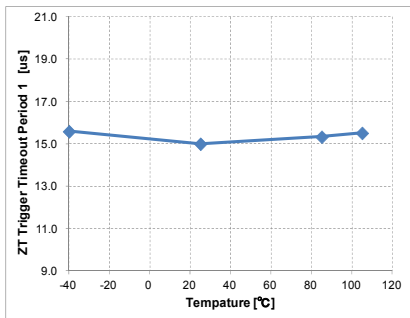

ZT Trigger Mask Time

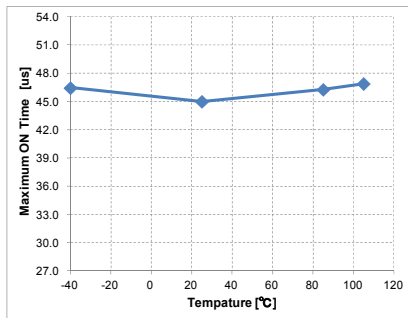

Maximum ON Time

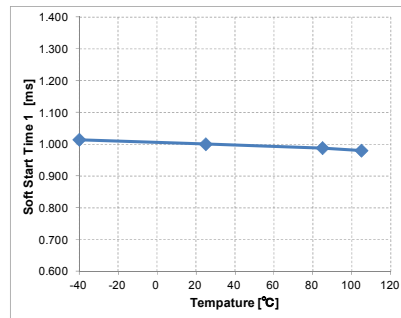

Soft Start Time 1

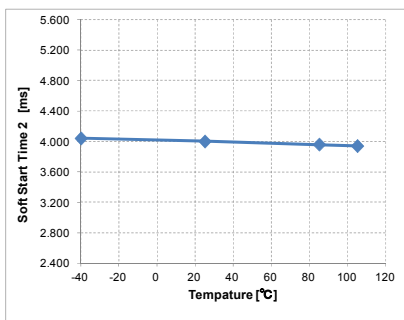

Soft Start Time 2

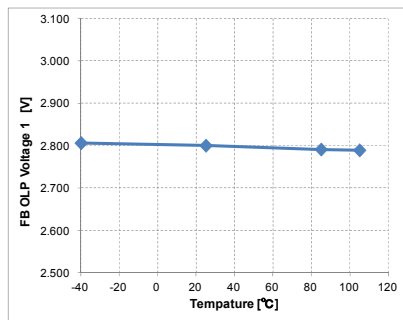

FB OLP Voltage 1

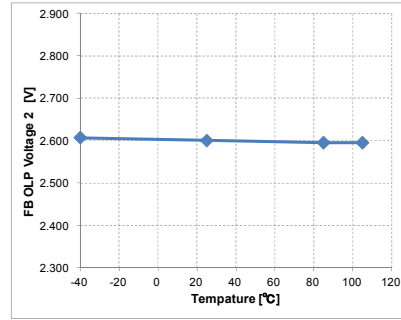

FB OLP Voltage 2

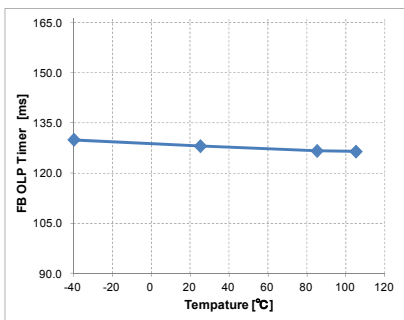

FB OLP Timer

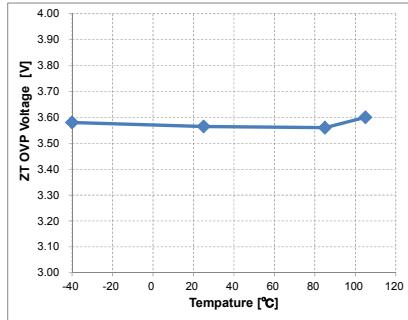

ZT OVP Voltage

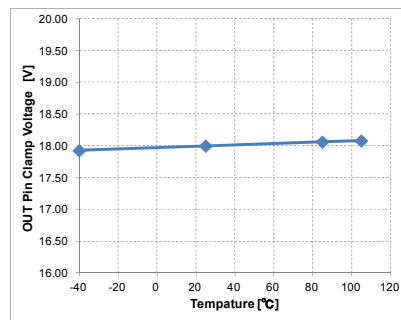

OUT Pin Clamp Voltage

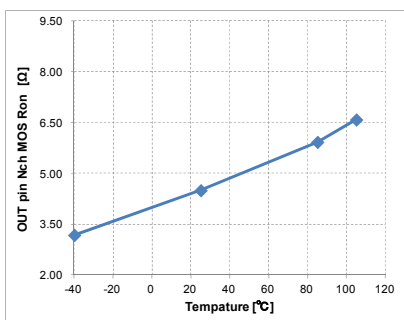

OUT pin Nch MOS Ron

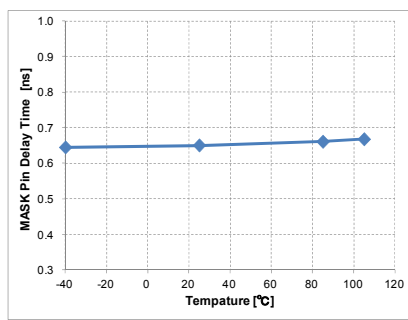

MASK Pin Delay Time

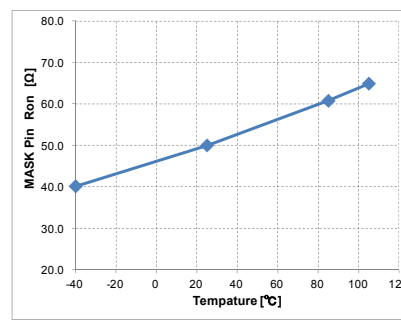

MASK Pin Ron

Operational Notes

1. Reverse Connection of Power Supply

Connecting the power supply in reverse polarity can damage the IC. Take precautions against reverse polarity when connecting the power supply, such as mounting an external diode between the power supply and the IC's power supply terminals.

2. Power Supply Lines

Design the PCB layout pattern to provide low impedance supply lines. Separate the ground and supply lines of the digital and analog blocks to prevent noise in the ground and supply lines of the digital block from affecting the analog block. Furthermore, connect a capacitor to ground at all power supply pins. Consider the effect of temperature and aging on the capacitance value when using electrolytic capacitors.

3. Ground Voltage

Ensure that no pins are at a voltage below that of the ground pin at any time, even during transient condition.

4. Ground Wiring Pattern

When using both small-signal and large-current ground traces, the two ground traces should be routed separately but connected to a single ground at the reference point of the application board to avoid fluctuations in the small-signal ground caused by large currents. Also ensure that the ground traces of external components do not cause variations on the ground voltage. The ground lines must be as short and thick as possible to reduce line impedance.

5. Thermal Consideration

Should by any chance the power dissipation rating be exceeded, the rise in temperature of the chip may result in deterioration of the properties of the chip. The absolute maximum rating of the Pd stated in this specification is when the IC is mounted on a 70mm x 70mm x 1.6mm glass epoxy board. In case of exceeding this absolute maximum rating, increase the board size and copper area to prevent exceeding the Pd rating.

6. Recommended Operating Conditions

These conditions represent a range within which the expected characteristics of the IC can be approximately obtained. The electrical characteristics are guaranteed under the conditions of each parameter.

7. Inrush Current

When power is first supplied to the IC, it is possible that the internal logic may be unstable and inrush current may flow instantaneously due to the internal powering sequence and delays, especially if the IC has more than one power supply. Therefore, give special consideration to power coupling capacitance, power wiring, width of ground wiring, and routing of connections.

8. Operation Under Strong Electromagnetic Field

Operating the IC in the presence of a strong electromagnetic field may cause the IC to malfunction.

9. Testing on Application Boards

When testing the IC on an application board, connecting a capacitor directly to a low-impedance output pin may subject the IC to stress. Always discharge capacitors completely after each process or step. The IC's power supply should always be turned OFF completely before connecting or removing it from the test setup during the inspection process. To prevent damage from static discharge, ground the IC during assembly and use similar precautions during transport and storage.

10. Inter-pin Short and Mounting Errors

Ensure that the direction and position are correct when mounting the IC on the PCB. Incorrect mounting may result in damaging the IC. Avoid nearby pins being shorted to each other especially to ground, power supply and output pin. Inter-pin shorts could be due to many reasons such as metal particles, water droplets (in very humid environment) and unintentional solder bridge deposited in between pins during assembly to name a few.

11. Unused Input Terminals

Input terminals of an IC are often connected to the gate of a MOS transistor. The gate has extremely high impedance and extremely low capacitance. If left unconnected, the electric field from the outside can easily charge it. The small charge acquired in this way is enough to produce a significant effect on the conduction through the transistor and cause unexpected operation of the IC. So unless otherwise specified, unused input terminals should be connected to the power supply or ground line.

Operational Notes – continued

12. Regarding Input Pins of the IC

This monolithic IC contains P+ isolation and P substrate layers between adjacent elements in order to keep them isolated. P-N junctions are formed at the intersection of the P layers with the N layers of other elements, creating a parasitic diode or transistor. For example (refer to figure below):

When $GND > Pin A$ and $GND > Pin B$, the P-N junction operates as a parasitic diode.
 When $GND > Pin B$, the P-N junction operates as a parasitic transistor.

Parasitic diodes inevitably occur in the structure of the IC. The operation of parasitic diodes can result in mutual interference among circuits, operational faults, or physical damage. Therefore, conditions that cause these diodes to operate, such as applying a voltage lower than the GND voltage to an input pin (and thus to the P substrate) should be avoided.

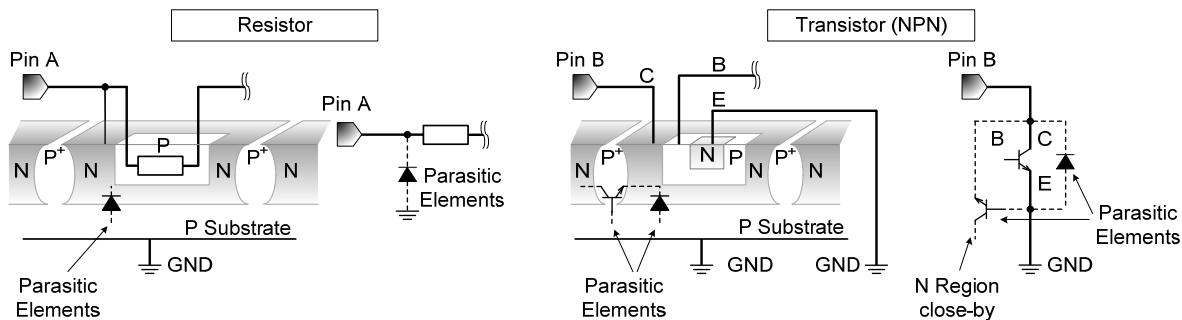

Figure 17. Example of Monolithic IC Structure

13. Ceramic Capacitor

When using a ceramic capacitor, determine the dielectric constant considering the change of capacitance with temperature and the decrease in nominal capacitance due to DC bias and others.

14. Area of Safe Operation (ASO)

Operate the IC such that the output voltage, output current, and power dissipation are all within the Area of Safe Operation (ASO).

15. Thermal Shutdown Circuit(TSD)

This IC has a built-in thermal shutdown circuit that prevents heat damage to the IC. Normal operation should always be within the IC's power dissipation rating. If however the rating is exceeded for a continued period, the junction temperature (T_j) will rise which will activate the TSD circuit that will turn OFF all output pins. The IC should be powered down and turned ON again to resume normal operation because the TSD circuit keeps the outputs at the OFF state even if the T_j falls below the TSD threshold. Note that the TSD circuit operates in a situation that exceeds the absolute maximum ratings and therefore, under no circumstances, should the TSD circuit be used in a set design or for any purpose other than protecting the IC from heat damage.

16. Over-Current Protection Circuit (OCP)

This IC has a built-in overcurrent protection circuit that activates when the output is accidentally shorted. However, it is strongly advised not to subject the IC to prolonged shorting of the output.

Ordering Information

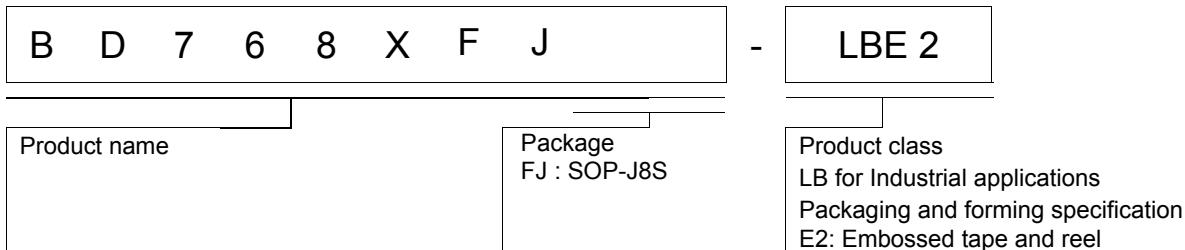

Marking Diagram

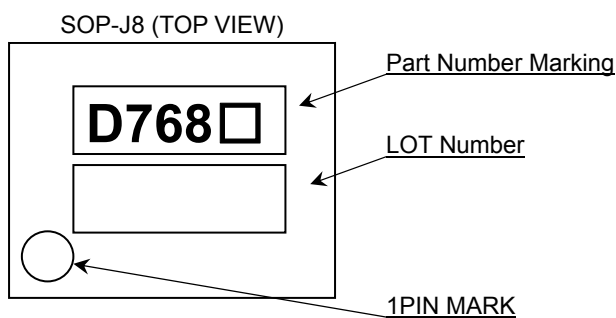

	Product name	Part Number Marking
1	BD7682FJ-LB	D7682
2	BD7683FJ-LB	D7683
3	BD7684FJ-LB	D7684
4	BD7685FJ-LB	D7685

Physical Dimension, Tape and Reel Information

Package Name	SOP-J8
--------------	--------

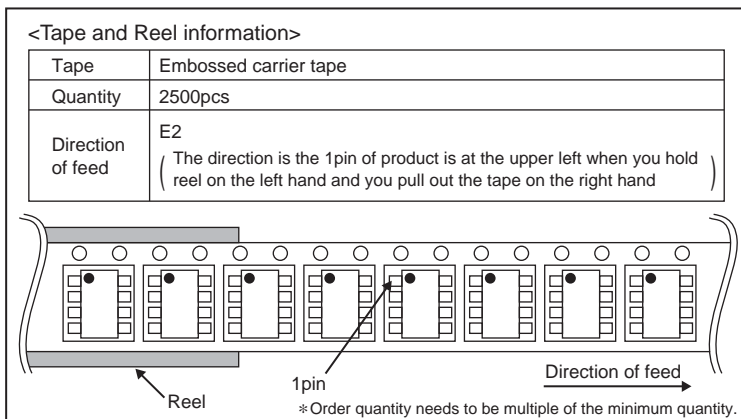
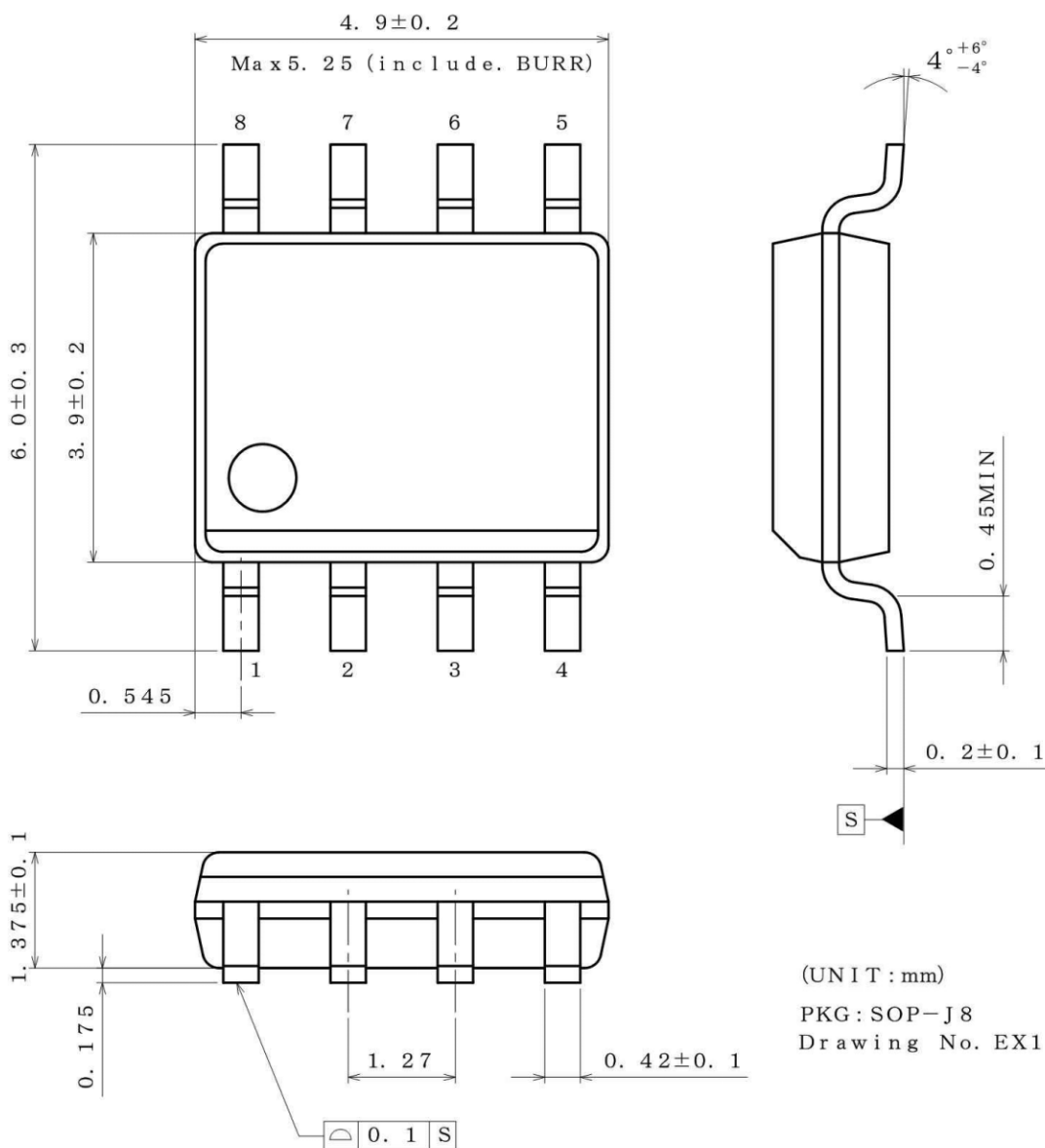

Revision History

Date	Revision	Changes
23.Mar.2015	001	New Release

Notice

Precaution on using ROHM Products

1. If you intend to use our Products in devices requiring extremely high reliability (such as medical equipment ^(Note 1), aircraft/spacecraft, nuclear power controllers, etc.) and whose malfunction or failure may cause loss of human life, bodily injury or serious damage to property ("Specific Applications"), please consult with the ROHM sales representative in advance. Unless otherwise agreed in writing by ROHM in advance, ROHM shall not be in any way responsible or liable for any damages, expenses or losses incurred by you or third parties arising from the use of any ROHM's Products for Specific Applications.

(Note1) Medical Equipment Classification of the Specific Applications

JAPAN	USA	EU	CHINA
CLASS III	CLASS III	CLASS II b	CLASS III
CLASS IV		CLASS III	

2. ROHM designs and manufactures its Products subject to strict quality control system. However, semiconductor products can fail or malfunction at a certain rate. Please be sure to implement, at your own responsibilities, adequate safety measures including but not limited to fail-safe design against the physical injury, damage to any property, which a failure or malfunction of our Products may cause. The following are examples of safety measures:
 - [a] Installation of protection circuits or other protective devices to improve system safety
 - [b] Installation of redundant circuits to reduce the impact of single or multiple circuit failure
3. Our Products are not designed under any special or extraordinary environments or conditions, as exemplified below. Accordingly, ROHM shall not be in any way responsible or liable for any damages, expenses or losses arising from the use of any ROHM's Products under any special or extraordinary environments or conditions. If you intend to use our Products under any special or extraordinary environments or conditions (as exemplified below), your independent verification and confirmation of product performance, reliability, etc, prior to use, must be necessary:
 - [a] Use of our Products in any types of liquid, including water, oils, chemicals, and organic solvents
 - [b] Use of our Products outdoors or in places where the Products are exposed to direct sunlight or dust
 - [c] Use of our Products in places where the Products are exposed to sea wind or corrosive gases, including Cl₂, H₂S, NH₃, SO₂, and NO₂
 - [d] Use of our Products in places where the Products are exposed to static electricity or electromagnetic waves
 - [e] Use of our Products in proximity to heat-producing components, plastic cords, or other flammable items
 - [f] Sealing or coating our Products with resin or other coating materials
 - [g] Use of our Products without cleaning residue of flux (even if you use no-clean type fluxes, cleaning residue of flux is recommended); or Washing our Products by using water or water-soluble cleaning agents for cleaning residue after soldering
 - [h] Use of the Products in places subject to dew condensation
4. The Products are not subject to radiation-proof design.
5. Please verify and confirm characteristics of the final or mounted products in using the Products.
6. In particular, if a transient load (a large amount of load applied in a short period of time, such as pulse. is applied, confirmation of performance characteristics after on-board mounting is strongly recommended. Avoid applying power exceeding normal rated power; exceeding the power rating under steady-state loading condition may negatively affect product performance and reliability.
7. De-rate Power Dissipation (Pd) depending on Ambient temperature (Ta). When used in sealed area, confirm the actual ambient temperature.
8. Confirm that operation temperature is within the specified range described in the product specification.
9. ROHM shall not be in any way responsible or liable for failure induced under deviant condition from what is defined in this document.

Precaution for Mounting / Circuit board design

1. When a highly active halogenous (chlorine, bromine, etc.) flux is used, the residue of flux may negatively affect product performance and reliability.
2. In principle, the reflow soldering method must be used on a surface-mount products, the flow soldering method must be used on a through hole mount products. If the flow soldering method is preferred on a surface-mount products, please consult with the ROHM representative in advance.

For details, please refer to ROHM Mounting specification

Precautions Regarding Application Examples and External Circuits

1. If change is made to the constant of an external circuit, please allow a sufficient margin considering variations of the characteristics of the Products and external components, including transient characteristics, as well as static characteristics.
2. You agree that application notes, reference designs, and associated data and information contained in this document are presented only as guidance for Products use. Therefore, in case you use such information, you are solely responsible for it and you must exercise your own independent verification and judgment in the use of such information contained in this document. ROHM shall not be in any way responsible or liable for any damages, expenses or losses incurred by you or third parties arising from the use of such information.

Precaution for Electrostatic

This Product is electrostatic sensitive product, which may be damaged due to electrostatic discharge. Please take proper caution in your manufacturing process and storage so that voltage exceeding the Products maximum rating will not be applied to Products. Please take special care under dry condition (e.g. Grounding of human body / equipment / solder iron, isolation from charged objects, setting of Ionizer, friction prevention and temperature / humidity control).

Precaution for Storage / Transportation

1. Product performance and soldered connections may deteriorate if the Products are stored in the places where:
 - [a] the Products are exposed to sea winds or corrosive gases, including Cl₂, H₂S, NH₃, SO₂, and NO₂
 - [b] the temperature or humidity exceeds those recommended by ROHM
 - [c] the Products are exposed to direct sunshine or condensation
 - [d] the Products are exposed to high Electrostatic
2. Even under ROHM recommended storage condition, solderability of products out of recommended storage time period may be degraded. It is strongly recommended to confirm solderability before using Products of which storage time is exceeding the recommended storage time period.
3. Store / transport cartons in the correct direction, which is indicated on a carton with a symbol. Otherwise bent leads may occur due to excessive stress applied when dropping of a carton.
4. Use Products within the specified time after opening a humidity barrier bag. Baking is required before using Products of which storage time is exceeding the recommended storage time period.

Precaution for Product Label

QR code printed on ROHM Products label is for ROHM's internal use only.

Precaution for Disposition

When disposing Products please dispose them properly using an authorized industry waste company.

Precaution for Foreign Exchange and Foreign Trade act

Since concerned goods might be fallen under listed items of export control prescribed by Foreign exchange and Foreign trade act, please consult with ROHM in case of export.

Precaution Regarding Intellectual Property Rights

1. All information and data including but not limited to application example contained in this document is for reference only. ROHM does not warrant that foregoing information or data will not infringe any intellectual property rights or any other rights of any third party regarding such information or data.
2. ROHM shall not have any obligations where the claims, actions or demands arising from the combination of the Products with other articles such as components, circuits, systems or external equipment (including software).
3. No license, expressly or implied, is granted hereby under any intellectual property rights or other rights of ROHM or any third parties with respect to the Products or the information contained in this document. Provided, however, that ROHM will not assert its intellectual property rights or other rights against you or your customers to the extent necessary to manufacture or sell products containing the Products, subject to the terms and conditions herein.

Other Precaution

1. This document may not be reprinted or reproduced, in whole or in part, without prior written consent of ROHM.
2. The Products may not be disassembled, converted, modified, reproduced or otherwise changed without prior written consent of ROHM.
3. In no event shall you use in any way whatsoever the Products and the related technical information contained in the Products or this document for any military purposes, including but not limited to, the development of mass-destruction weapons.
4. The proper names of companies or products described in this document are trademarks or registered trademarks of ROHM, its affiliated companies or third parties.

General Precaution

1. Before you use our Products, you are requested to carefully read this document and fully understand its contents. ROHM shall not be in any way responsible or liable for failure, malfunction or accident arising from the use of any ROHM's Products against warning, caution or note contained in this document.
2. All information contained in this document is current as of the issuing date and subject to change without any prior notice. Before purchasing or using ROHM's Products, please confirm the latest information with a ROHM sales representative.
3. The information contained in this document is provided on an "as is" basis and ROHM does not warrant that all information contained in this document is accurate and/or error-free. ROHM shall not be in any way responsible or liable for any damages, expenses or losses incurred by you or third parties resulting from inaccuracy or errors of or concerning such information.

Mouser Electronics

Authorized Distributor

Click to View Pricing, Inventory, Delivery & Lifecycle Information:

[ROHM Semiconductor:](#)

[BD7682FJ-LBE2](#)

Компания «Life Electronics» занимается поставками электронных компонентов импортного и отечественного производства от производителей и со складов крупных дистрибьюторов Европы, Америки и Азии.

С конца 2013 года компания активно расширяет линейку поставок компонентов по направлению коаксиальный кабель, кварцевые генераторы и конденсаторы (керамические, пленочные, электролитические), за счёт заключения дистрибьюторских договоров

Мы предлагаем:

- Конкурентоспособные цены и скидки постоянным клиентам.
- Специальные условия для постоянных клиентов.
- Подбор аналогов.
- Поставку компонентов в любых объемах, удовлетворяющих вашим потребностям.
- Приемлемые сроки поставки, возможна ускоренная поставка.
- Доставку товара в любую точку России и стран СНГ.
- Комплексную поставку.
- Работу по проектам и поставку образцов.
- Формирование склада под заказчика.
- Сертификаты соответствия на поставляемую продукцию (по желанию клиента).
- Тестирование поставляемой продукции.
- Поставку компонентов, требующих военную и космическую приемку.
- Входной контроль качества.
- Наличие сертификата ISO.

В составе нашей компании организован Конструкторский отдел, призванный помогать разработчикам, и инженерам.

Конструкторский отдел помогает осуществить:

- Регистрацию проекта у производителя компонентов.
- Техническую поддержку проекта.
- Защиту от снятия компонента с производства.
- Оценку стоимости проекта по компонентам.
- Изготовление тестовой платы монтаж и пусконаладочные работы.



Тел: +7 (812) 336 43 04 (многоканальный)

Email: org@lifeelectronics.ru