

**Silicon Switching Diode**

- For high-speed switching applications
- Pb-free (RoHS compliant) package <sup>1)</sup>
- Qualified according AEC Q101

**BAS16**  
**BAS16W**
**BAS16-02L**  
**BAS16-02V**  
**BAS16-02W**  
**BAS16-03W**
**BAS16S**  
**BAS16U**
**BAS16-07L4**

Type	Package	Configuration	Marking
BAS16	SOT23	single	A6s
BAS16-02L*	TSLP-2-1	single, leadless	A6
BAS16-02V	SC79	single	6
BAS16-02W	SCD80	single	A6
BAS16-03W	SOD323	single	white B
BAS16-07L4*	TSLP-4-4	parallel pair, leadless	6A
BAS16S	SOT363	parallel triple	A6s
BAS16U	SC74	parallel triple	A6s
BAS16W	SOT323	single	A6s

\* Preliminary Data

<sup>1</sup>Pb-containing package may be available upon special request

**Maximum Ratings** at  $T_A = 25\text{ °C}$ , unless otherwise specified

Parameter	Symbol	Value	Unit
Diode reverse voltage	$V_R$	80	V
Peak reverse voltage	$V_{RM}$	85	
Forward current	$I_F$		mA
BAS16		250	
BAS16-02L, -07L4		200	
BAS16-02V, -02W		200	
BAS16-03W		250	
BAS16S		200	
BAS16U		200	
BAS16W		250	
Non-repetitive peak surge forward current	$I_{FSM}$		A
$t = 1\ \mu\text{s}$ , BAS16/ S/ U/ W/ -03W		4.5	
$t = 1\ \mu\text{s}$ , BAS16-02L/ -02V/ -02W/ -07L4		2.5	
$t = 1\ \text{s}$		0.5	
Total power dissipation	$P_{tot}$		mW
BAS16, $T_S \leq 54\text{ °C}$		370	
BAS16-02L, -07L4, $T_S \leq 130\text{ °C}$		250	
BAS16-02V, -02W, $T_S \leq 120\text{ °C}$		250	
BAS16-03W, $T_S \leq 116\text{ °C}$		250	
BAS16S, $T_S \leq 85\text{ °C}$		250	
BAS16U, $T_S \leq 113\text{ °C}$		250	
BAS16W, $T_S \leq 119\text{ °C}$		250	
Junction temperature	$T_j$	150	°C
Storage temperature	$T_{stg}$	-65 ... 150	

**Thermal Resistance**

Parameter	Symbol	Value	Unit
Junction - soldering point <sup>1)</sup>	$R_{thJS}$		K/W
BAS16, BAS16S		≤ 260	
BAS16-02L, -07L4		≤ 80	
BAS16-02V, -02W		≤ 120	
BAS16-03W		≤ 135	
BAS16U		≤ 150	
BAS16W		≤ 125	

**Electrical Characteristics at  $T_A = 25^\circ\text{C}$ , unless otherwise specified**

Parameter	Symbol	Values			Unit
		min.	typ.	max.	
<b>DC Characteristics</b>					
Breakdown voltage $I_{(BR)} = 100 \mu\text{A}$	$V_{(BR)}$	85	-	-	V
Reverse current $V_R = 75 \text{ V}$ $V_R = 25 \text{ V}, T_A = 150^\circ\text{C}$ $V_R = 75 \text{ V}, T_A = 150^\circ\text{C}$	$I_R$	-	-	1 30 50	$\mu\text{A}$
Forward voltage $I_F = 1 \text{ mA}$ $I_F = 10 \text{ mA}$ $I_F = 50 \text{ mA}$ $I_F = 100 \text{ mA}$ $I_F = 150 \text{ mA}$	$V_F$	-	-	715 855 1000 1200 1250	mV
Forward recovery voltage $I_F = 10 \text{ mA}, t_P = 20 \text{ ns}$	$V_{fr}$	-	-	1.75	V

<sup>1)</sup>For calculation of  $R_{thJA}$  please refer to Application Note Thermal Resistance

**Electrical Characteristics at  $T_A = 25^\circ\text{C}$ , unless otherwise specified**

Parameter	Symbol	Values			Unit
		min.	typ.	max.	
<b>AC Characteristics</b>					
Diode capacitance $V_R = 0\text{ V}, f = 1\text{ MHz}$	$C_T$	-	-	2	pF
Reverse recovery time $I_F = 10\text{ mA}, I_R = 10\text{ mA}$ , measured at $I_R = 1\text{ mA}$ , $R_L = 100\ \Omega$	$t_{rr}$	-	-	4	ns

**Test circuit for reverse recovery time**

Pulse generator:  $t_p = 100\text{ ns}$ ,  $D = 0.05$ ,  $t_r = 0.6\text{ ns}$ ,  
 $R_i = 50\ \Omega$

Oscilloscope:  $R = 50\ \Omega$ ,  $t_r = 0.35\text{ ns}$ ,  $C = 0.05\text{ pF}$

Reverse current  $I_R = f(T_A)$

$V_R = \text{Parameter}$



Forward Voltage  $V_F = f(T_A)$

$I_F = \text{Parameter}$



Forward current  $I_F = f(V_F)$

$T_A = 25^\circ\text{C}$



Forward current  $I_F = f(T_S)$

BAS16

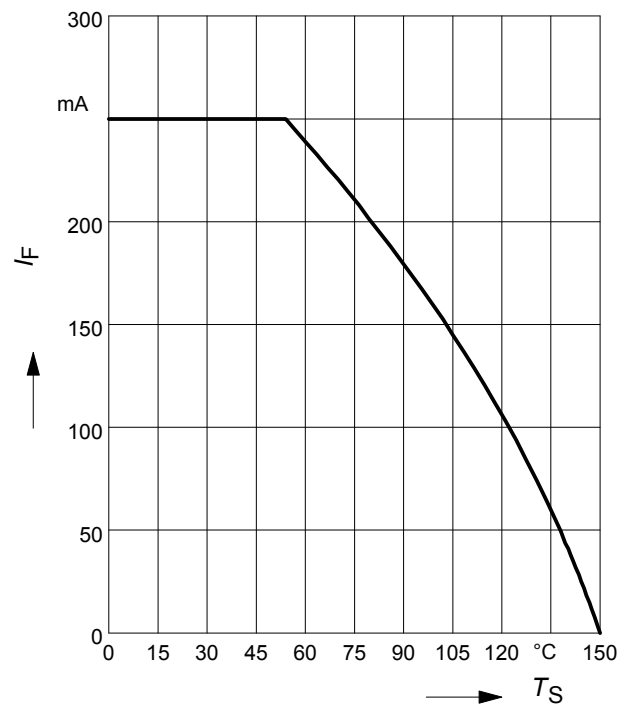

Forward current  $I_F = f(T_S)$

BAS16-02L, -07L4



Forward current  $I_F = f(T_S)$

BAS16-02V, -02W

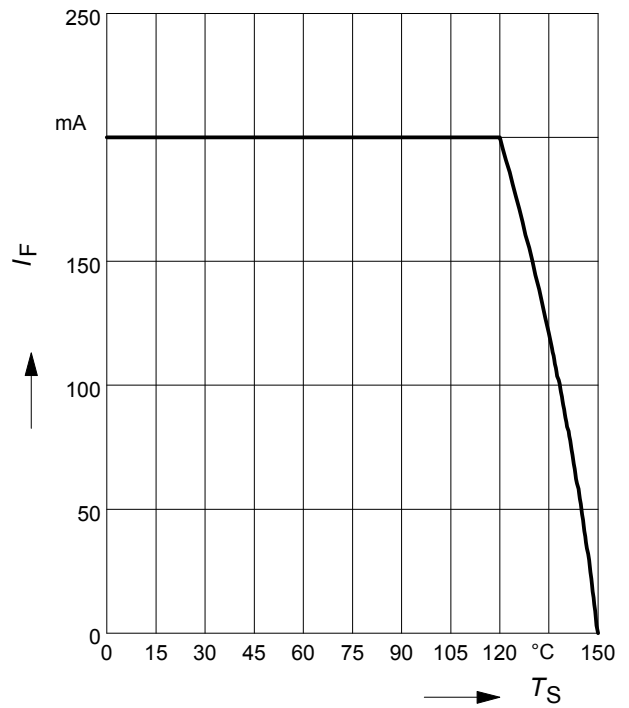

Forward current  $I_F = f(T_S)$

BAS16-03W



Forward current  $I_F = f(T_S)$

BAS16S

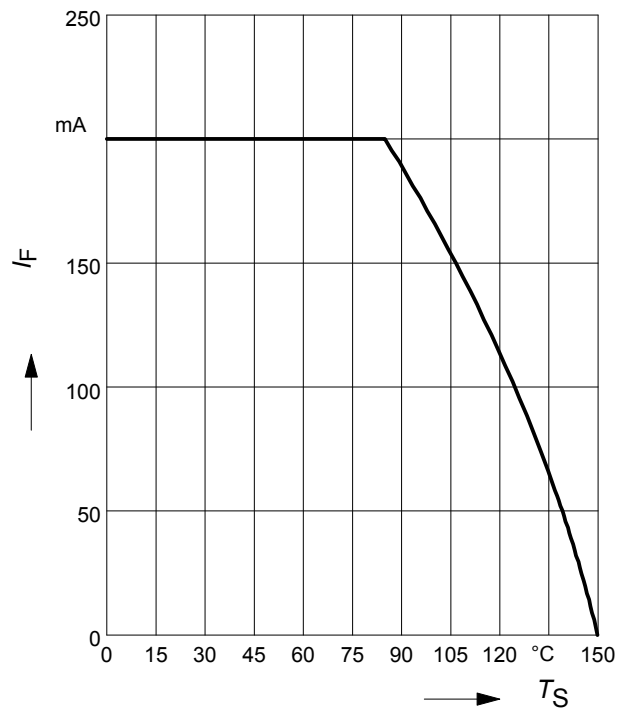

**Forward current  $I_F = f(T_S)$**

BAS16U



**Forward current  $I_F = f(T_S)$**

BAS16W



**Permissible Puls Load  $R_{thJS} = f(t_p)$**

BAS16



**Permissible Pulse Load**

$I_{Fmax} / I_{FDC} = f(t_p)$

BAS16



**Permissible Puls Load  $R_{thJS} = f(t_p)$**

BAS16-02L, -07L4



**Permissible Pulse Load**

$I_{Fmax} / I_{FDC} = f(t_p)$

BAS16-02L, -07L4



**Permissible Puls Load  $R_{thJS} = f(t_p)$**

BAS16-02V, -02W



**Permissible Pulse Load**

$I_{Fmax} / I_{FDC} = f(t_p)$

BAS16-02V, -02W





**Permissible Puls Load  $R_{thJS} = f(t_p)$**

BAS16-03W



**Permissible Pulse Load**

$I_{Fmax} / I_{FDC} = f(t_p)$

BAS16-03W

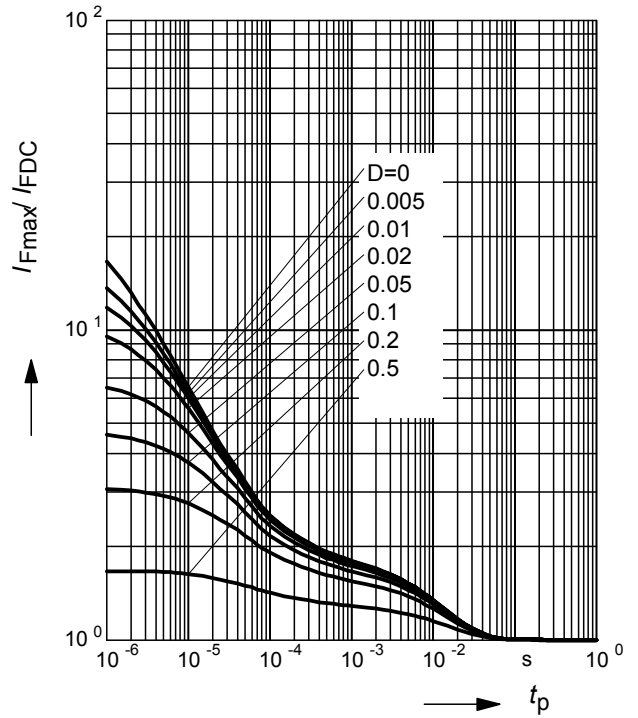

**Permissible Puls Load  $R_{thJS} = f(t_p)$**

BAS16S



**Permissible Pulse Load**

$I_{Fmax} / I_{FDC} = f(t_p)$

BAS16S

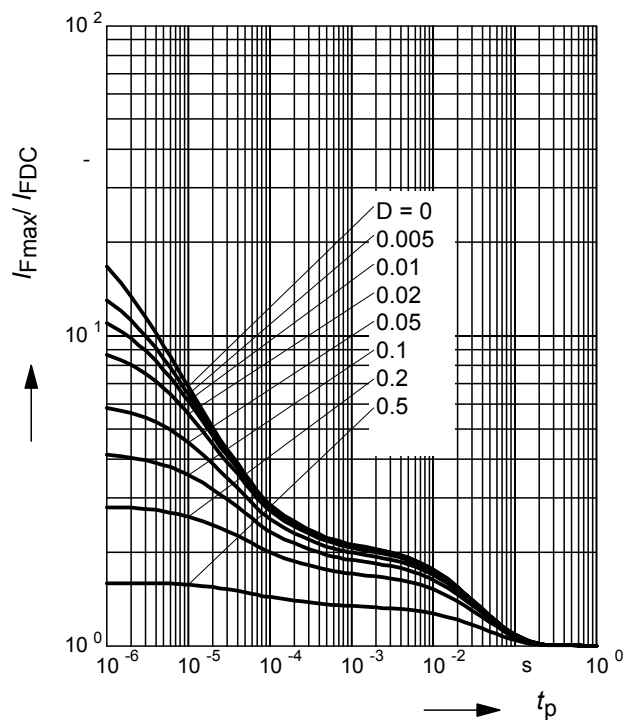

**Permissible Puls Load  $R_{thJS} = f(t_p)$**

BAS16U



**Permissible Pulse Load**

$I_{Fmax} / I_{FDC} = f(t_p)$

BAS16U



**Permissible Puls Load  $R_{thJS} = f(t_p)$**

BAS16W



**Permissible Pulse Load**

$I_{Fmax} / I_{FDC} = f(t_p)$

BAS16W



Package Outline



Foot Print



Marking Layout (Example)

Small variations in positioning of Date code, Type code and Manufacture are possible.



Standard Packing

Reel  $\varnothing$ 180 mm = 3.000 Pieces/Reel  
 Reel  $\varnothing$ 330 mm = 10.000 Pieces/Reel

For symmetric types no defined Pin 1 orientation in reel.



Package Outline

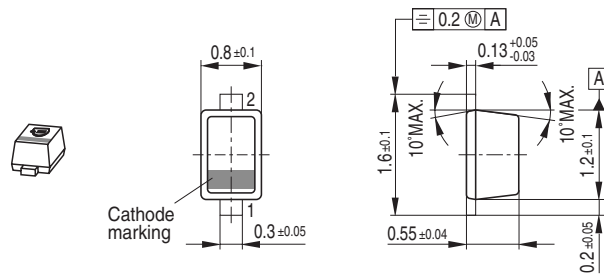

Foot Print



Marking Layout (Example)

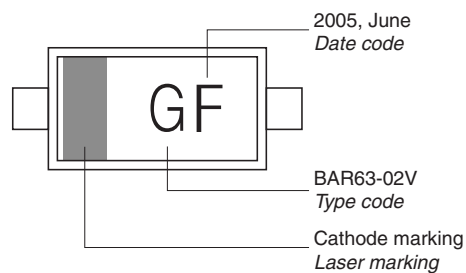

Standard Packing

Reel  $\varnothing$ 180 mm = 3.000 Pieces/Reel  
 Reel  $\varnothing$ 180 mm = 8.000 Pieces/Reel (2 mm Pitch)  
 Reel  $\varnothing$ 330 mm = 10.000 Pieces/Reel

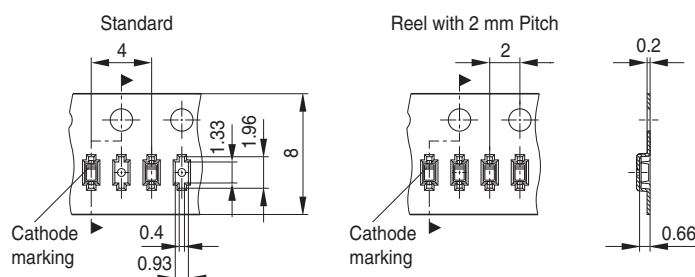

Package Outline



Foot Print

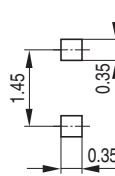

Marking Layout (Example)



Standard Packing

Reel  $\varnothing$ 180 mm = 3.000 Pieces/Reel  
 Reel  $\varnothing$ 180 mm = 8.000 Pieces/Reel (2 mm Pitch)  
 Reel  $\varnothing$ 330 mm = 10.000 Pieces/Reel



Date Code marking for discrete packages with one digit (SCD80, SC79, SC75<sup>1)</sup>) CES-Code

Month	2003	2004	2005	2006	2007	2008	2009	2010	2011	2012	2013	2014
01	a	p	A	P	a	p	A	P	a	p	A	P
02	b	q	B	Q	b	q	B	Q	b	q	B	Q
03	c	r	C	R	c	r	C	R	c	r	C	R
04	d	s	D	S	d	s	D	S	d	s	D	S
05	e	t	E	T	e	t	E	T	e	t	E	T
06	f	u	F	U	f	u	F	U	f	u	F	U
07	g	v	G	V	g	v	G	V	g	v	G	V
08	h	x	H	X	h	x	H	X	h	x	H	X
09	j	y	J	Y	j	y	J	Y	j	y	J	Y
10	k	z	K	Z	k	z	K	Z	k	z	K	Z
11	l	2	L	4	l	2	L	4	l	2	L	4
12	n	3	N	5	n	3	N	5	n	3	N	5

1) New Marking Layout for SC75, implemented at October 2005.

### Package Outline

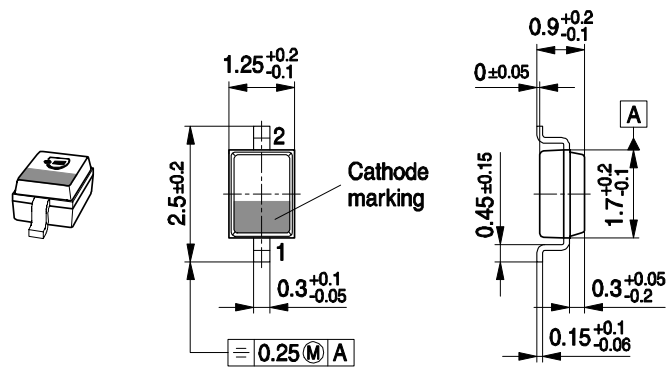

### Foot Print



### Marking Layout (Example)

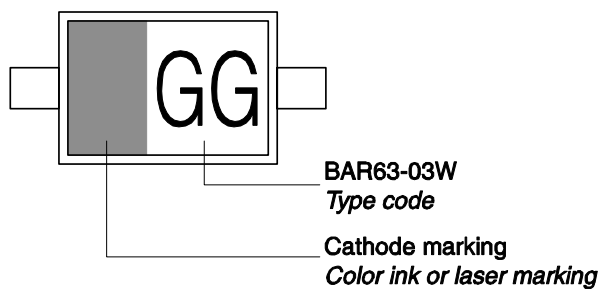

### Standard Packing

Reel ø180 mm = 3.000 Pieces/Reel  
 Reel ø330 mm = 10.000 Pieces/Reel

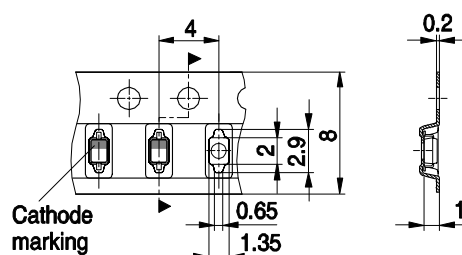

Package Outline



Foot Print

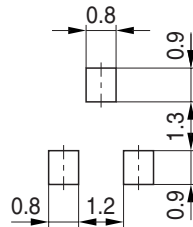

Marking Layout (Example)

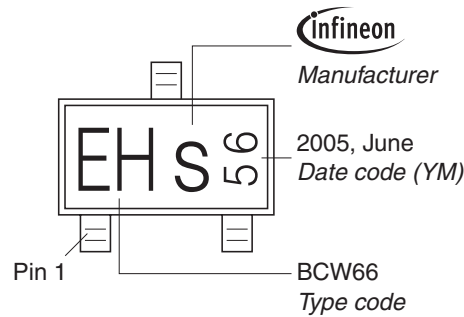

Standard Packing

Reel  $\varnothing$ 180 mm = 3.000 Pieces/Reel  
 Reel  $\varnothing$ 330 mm = 10.000 Pieces/Reel

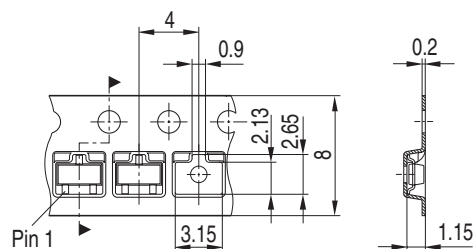



Package Outline



Foot Print



Marking Layout (Example)



Standard Packing

Reel ø180 mm = 3.000 Pieces/Reel  
 Reel ø330 mm = 10.000 Pieces/Reel



### Package Outline



### Foot Print



### Marking Layout (Example)

Small variations in positioning of Date code, Type code and Manufacture are possible.



### Standard Packing

Reel  $\varnothing$ 180 mm = 3.000 Pieces/Reel  
 Reel  $\varnothing$ 330 mm = 10.000 Pieces/Reel

For symmetric types no defined Pin 1 orientation in reel.



### Package Outline

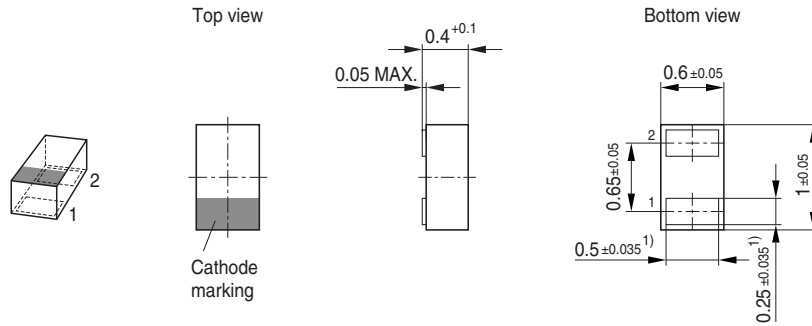

1) Dimension applies to plated terminal

### Foot Print

For board assembly information please refer to Infineon website "Packages"



■ Copper □ Solder mask

▨ Stencil apertures

### Marking Layout (Example)

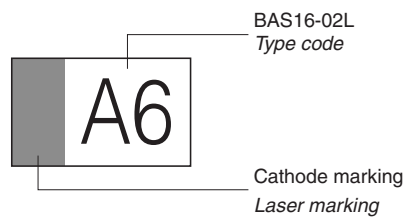

BAS16-02L  
Type code

Cathode marking  
Laser marking

### Standard Packing

Reel  $\varnothing$ 180 mm = 15.000 Pieces/Reel  
Reel  $\varnothing$ 330 mm = 50.000 Pieces/Reel (optional)

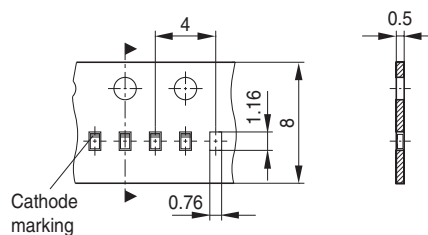



Edition 2006-02-01  
Published by  
Infineon Technologies AG  
81726 München, Germany  
© Infineon Technologies AG 2007.  
All Rights Reserved.

### **Attention please!**

The information given in this dokument shall in no event be regarded as a guarantee of conditions or characteristics ("Beschaffenheitsgarantie"). With respect to any examples or hints given herein, any typical values stated herein and/or any information regarding the application of the device, Infineon Technologies hereby disclaims any and all warranties and liabilities of any kind, including without limitation warranties of non-infringement of intellectual property rights of any third party.

### **Information**

For further information on technology, delivery terms and conditions and prices please contact your nearest Infineon Technologies Office ([www.infineon.com](http://www.infineon.com)).

### **Warnings**

Due to technical requirements components may contain dangerous substances. For information on the types in question please contact your nearest Infineon Technologies Office.

Infineon Technologies Components may only be used in life-support devices or systems with the express written approval of Infineon Technologies, if a failure of such components can reasonably be expected to cause the failure of that life-support device or system, or to affect the safety or effectiveness of that device or system.

Life support devices or systems are intended to be implanted in the human body, or to support and/or maintain and sustain and/or protect human life. If they fail, it is reasonable to assume that the health of the user or other persons may be endangered.

Компания «Life Electronics» занимается поставками электронных компонентов импортного и отечественного производства от производителей и со складов крупных дистрибьюторов Европы, Америки и Азии.

С конца 2013 года компания активно расширяет линейку поставок компонентов по направлению коаксиальный кабель, кварцевые генераторы и конденсаторы (керамические, пленочные, электролитические), за счёт заключения дистрибьюторских договоров

Мы предлагаем:

- Конкурентоспособные цены и скидки постоянным клиентам.
- Специальные условия для постоянных клиентов.
- Подбор аналогов.
- Поставку компонентов в любых объемах, удовлетворяющих вашим потребностям.
- Приемлемые сроки поставки, возможна ускоренная поставка.
- Доставку товара в любую точку России и стран СНГ.
- Комплексную поставку.
- Работу по проектам и поставку образцов.
- Формирование склада под заказчика.
- Сертификаты соответствия на поставляемую продукцию (по желанию клиента).
- Тестирование поставляемой продукции.
- Поставку компонентов, требующих военную и космическую приемку.
- Входной контроль качества.
- Наличие сертификата ISO.

В составе нашей компании организован Конструкторский отдел, призванный помогать разработчикам, и инженерам.

Конструкторский отдел помогает осуществить:

- Регистрацию проекта у производителя компонентов.
- Техническую поддержку проекта.
- Защиту от снятия компонента с производства.
- Оценку стоимости проекта по компонентам.
- Изготовление тестовой платы монтаж и пусконаладочные работы.

