

**PLEASE CHECK WWW.MOLEX.COM FOR LATEST PART INFORMATION**

**Part Number:** [0003062031](#)  
**Status:** **Active**  
**Overview:** [standard\\_062](#)  
**Description:** 1.57mm (.062") Diameter Standard .062 Pin and Socket Plug Housing, 3 Circuits, With Standard Mounting Ears

**Documents:**

<a href="#">3D Model</a>	<a href="#">Product Specification PS-02-06 (PDF)</a>
<a href="#">Packaging Specification (PDF)</a>	<a href="#">RoHS Certificate of Compliance (PDF)</a>
<a href="#">Drawing (PDF)</a>	

**Agency Certification**

CSA	LR19980
TUV	R72081037
UL	E29179

**General**

Product Family	Crimp Housings
Series	<a href="#">1625</a>
Comments	Polarized to Mating Part
Overview	<a href="#">standard_062</a>
Product Name	Standard .062"

**Physical**

Breakaway	No
Circuits (maximum)	3
Circuits Detail	1x3
Color - Resin	Natural
Flammability	94V-2
Gender	Plug
Glow-Wire Compliant	No
Keying to Mating Part	None
Lock to Mating Part	Yes
Material - Resin	Nylon
Number of Rows	1
Packaging Type	Bag
Panel Mount	Yes
Pitch - Mating Interface (in)	0.145 In
Pitch - Mating Interface (mm)	3.96 mm
Pitch - Term. Interface (in)	0.145 In
Pitch - Term. Interface (mm)	3.96 mm
Polarized to Mating Part	Yes
Ports	1
Stackable	No
Temperature Range - Operating	-40°C to +105°C

**Electrical**

Current - Maximum per Contact	5A
-------------------------------	----

**Material Info**

Old Part Number	1625-3P
-----------------	---------

**Reference - Drawing Numbers**

Packaging Specification	PK-1625-001
Product Specification	PS-02-06
Sales Drawing	SD-1625-3*

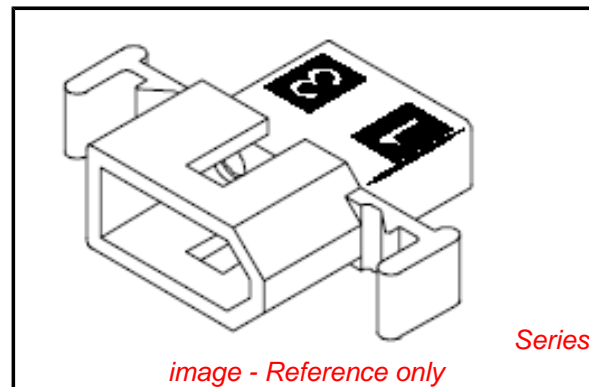

image - Reference only

**EU RoHS**

**ELV and RoHS Compliant**  
**REACH SVHC**  
**Contains SVHC: No**  
**Halogen-Free**  
**Status**

**China RoHS**



**Need more information on product environmental compliance?**

Email [productcompliance@molex.com](mailto:productcompliance@molex.com)  
 For a multiple part number RoHS Certificate of Compliance, [click here](#)

Please visit the [Contact Us](#) section for any non-product compliance questions.

**Search Parts in this Series**

[1625Series](#)

**Mates With**

[1625](#) Receptacle

**Use With**

Female Crimp Terminals [1561](#)[Link:4559](#), [4529](#), [2190](#), [2189](#), [1787](#), [1855](#). Male Crimp Terminals [1560](#), [1786](#), [1854](#), [1778](#). Male PC Tail Terminals. [1779](#) Female PC Tail Terminals

This document was generated on 06/07/2010

**PLEASE CHECK [WWW.MOLEX.COM](http://WWW.MOLEX.COM) FOR LATEST PART INFORMATION**

RECEPTACLE

PLUG

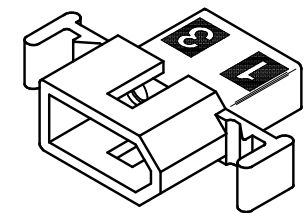
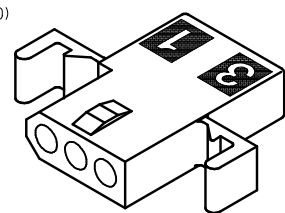
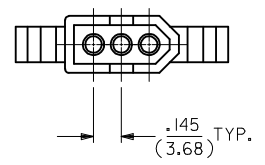
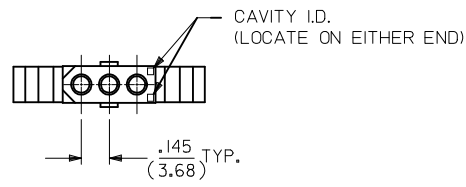
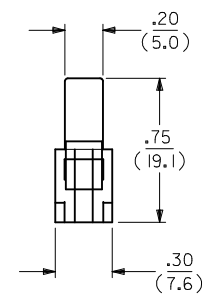
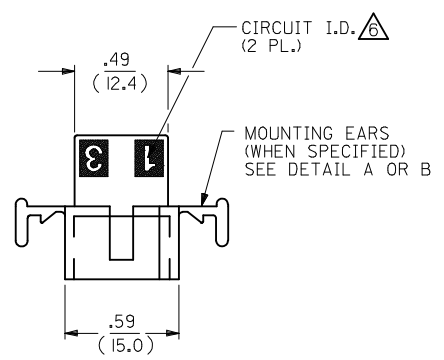
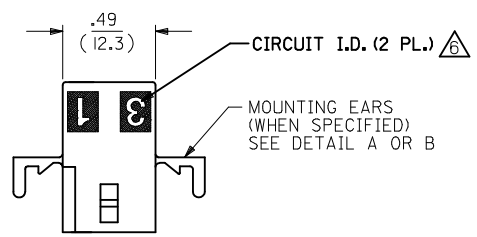
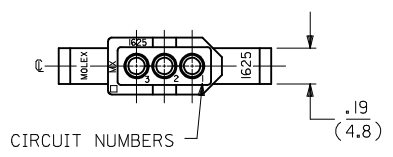
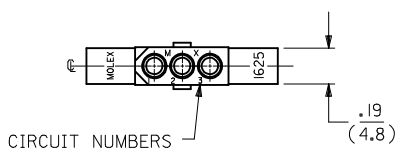

RECEPTACLE HOUSING  
SHOWN WITH STANDARD EARS

PLUG HOUSING  
SHOWN WITH STANDARD EARS

UPDATE REV. LEVEL EC NO: UCP2007-1925 DRAWN: PRIDDER CHKD: AELHAG APPR: FSMITH 2007/02/08 2007/02/12 2007/02/12	QUALITY SYMBOLS ▽=0 ▽=0	GENERAL TOLERANCES (UNLESS SPECIFIED)		DIMENSION STYLE IN/MM	SCALE ---	DESIGN UNITS INCH	THIRD ANGLE PROJECTION		
		4 PLACES ± --- ± ---	3 PLACES ± --- ± .010	DRAWN BY KBW	DATE 1/26/89	TITLE PLUG AND RECEPTACLE HOUSINGS, 3 CIRCUIT, .062 DIA.			
		2 PLACES ± 0.25 ± .014	1 PLACE ± 0.35 ± ---	CHECKED BY RW	DATE 1/26/89	MOLEX INCORPORATED			
		ANGULAR ± 1/2°		APPROVED BY RAS	DATE 1/26/89	MATERIAL NO. SEE CHART	DOCUMENT NO. SD-1625-3*	SHEET NO. 1 OF 2	
DRAFT WHERE APPLICABLE MUST REMAIN WITHIN DIMENSIONS		SIZE C		THIS DRAWING CONTAINS INFORMATION THAT IS PROPRIETARY TO MOLEX INCORPORATED AND SHOULD NOT BE USED WITHOUT WRITTEN PERMISSION					

PLUG		
PART NO.	ENG. NO.	
03-06-2031	1625-3P	
03-06-2032	1625-3P1	
03-06-2034	1625-3P4BK	
03-06-7032	1625-3P1BK	<b>OBSOLETE</b>
03-06-2033	1625-3P4	

RECEPTACLE		
PART NO.	ENG. NO.	
03-06-1033	1625-3R2	
03-06-1031	1625-3R	
03-06-1032	1625-3R1	
03-06-6031	1625-3RBK	
03-06-6032	1625-3R1BK	<b>OBSOLETE</b>
03-06-1034	1625-3R3	
03-06-1038	1625-3R4	

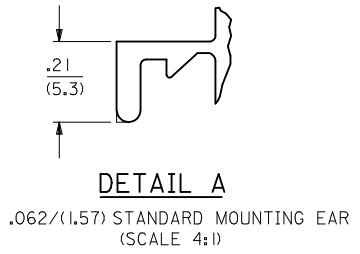

**LEGEND:**  
 1625-3\*\*\*\*  
 CIRCUIT SIZE  
 P = PLUG  
 R = RECEPTACLE

BLANK = WITH STANDARD EARS  
 1 = WITHOUT EARS  
 2 = WITHOUT EARS, WITHOUT DETENTS  
 3 = WITH STD. EARS, WITHOUT DETENTS  
 4 = WITH PREBENT EARS

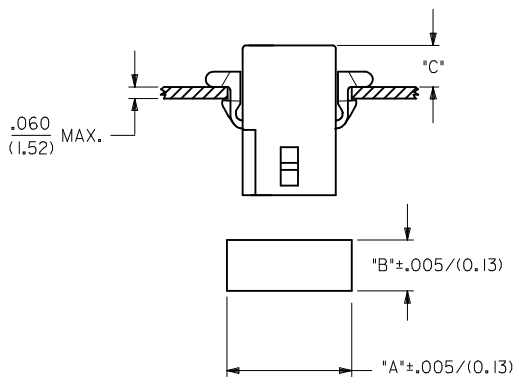

HOUSING	DIM. "A"	DIM. "B"	"C" PREBENT EAR	"C" STANDARD EAR
PLUG	.754/(19.15)	.318/(8.08)	.19/(4.8)	.18/(4.6)
RECEPT.	.650/(16.51)	.265/(6.73)	.21/(5.3)	.20/(5.1)

**COLOR:**  
 BLANK = NATURAL COLOR  
 AM = AMBER BK = BLACK BU = BLUE  
 BN = BROWN GY = GRAY GN = GREEN  
 OR = ORANGE RD = RED YW = YELLOW

RECOMMENDED PANEL OPENING

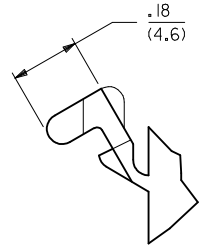
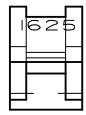

- NOTES:-**
- MATERIAL: NYLON TYPE 6/6, 94V-2.
  - FINISH: NONE.
  - PRODUCT SPECIFICATION: PS-02-06.
  - PACKAGING SPECS: BULK PACK PER PK-1625-001.
  - ACCEPTS MOLEX .062" SERIES TERMINALS.

ETCHED CIRCUIT I.D. NUMBERS ON HOUSING MAY OR MAY NOT BE PRESENT.

7. PARTS CONFORM TO CLASS B REQUIREMENTS OF COSMETIC SPECIFICATION PS-45499-002.

<b>REVISE NOTE # 6</b> EC NO: UCP2010-0366 DRW: AELHAG CHKD: J.BELL APPR: F.S.MITH	2009/08/11 2009/08/11 2009/08/12	DESCRIPTION M3	QUALITY SYMBOLS ▽=0 ▽=0	GENERAL TOLERANCES (UNLESS SPECIFIED)		DIMENSION STYLE <b>IN/MM</b>		SCALE <b>1:1</b>	DESIGN UNITS <b>INCH</b>	THIRD ANGLE PROJECTION
				4 PLACES ± --- ± ---	DRAWN BY KBW	DATE 01/26/89	<b>PLUG AND RECEPTACLE HOUSINGS, 3 CIRCUIT, .062 DIA.</b>			
				3 PLACES ± --- ±.010	CHECKED BY RW	DATE 01/26/89				
				2 PLACES ± 0.25 ±.014	APPROVED BY RAS	DATE 01/26/89		<b>MOLEX INCORPORATED</b>	SHEET NO. <b>2 OF 2</b>	
1 PLACE ± 0.35 ± ---	ANGULAR ± 1/2°		MATERIAL NO. <b>SEE CHART</b>	DOCUMENT NO. <b>SD-1625-3*</b>	THIS DRAWING CONTAINS INFORMATION THAT IS PROPRIETARY TO MOLEX INCORPORATED AND SHOULD NOT BE USED WITHOUT WRITTEN PERMISSION					

Компания «Life Electronics» занимается поставками электронных компонентов импортного и отечественного производства от производителей и со складов крупных дистрибьюторов Европы, Америки и Азии.

С конца 2013 года компания активно расширяет линейку поставок компонентов по направлению коаксиальный кабель, кварцевые генераторы и конденсаторы (керамические, пленочные, электролитические), за счёт заключения дистрибьюторских договоров

Мы предлагаем:

- Конкурентоспособные цены и скидки постоянным клиентам.
- Специальные условия для постоянных клиентов.
- Подбор аналогов.
- Поставку компонентов в любых объемах, удовлетворяющих вашим потребностям.
- Приемлемые сроки поставки, возможна ускоренная поставка.
- Доставку товара в любую точку России и стран СНГ.
- Комплексную поставку.
- Работу по проектам и поставку образцов.
- Формирование склада под заказчика.
- Сертификаты соответствия на поставляемую продукцию (по желанию клиента).
- Тестирование поставляемой продукции.
- Поставку компонентов, требующих военную и космическую приемку.
- Входной контроль качества.
- Наличие сертификата ISO.

В составе нашей компании организован Конструкторский отдел, призванный помогать разработчикам, и инженерам.

Конструкторский отдел помогает осуществить:

- Регистрацию проекта у производителя компонентов.
- Техническую поддержку проекта.
- Защиту от снятия компонента с производства.
- Оценку стоимости проекта по компонентам.
- Изготовление тестовой платы монтаж и пусконаладочные работы.



Тел: +7 (812) 336 43 04 (многоканальный)

Email: [org@lifeelectronics.ru](mailto:org@lifeelectronics.ru)