

Features

- Attenuation: 1 dB Steps to 15 dB
- Low DC Power Consumption
- Small Footprint, JEDEC Package
- Integral TTL Driver
- 50 Ohm Impedance
- Test Boards Available
- Tape and Reel Packaging Available
- CSP-1 Package

Description

M/A-COM's AT90-0413 is a GaAs FET 4-Bit digital attenuator with integral driver. Step size is 1 dB providing a 15 dB attenuation range. This device is in an PQFN plastic surface mount package. The AT90-0413 is suited for applications where accuracy, fast speed, low power consumption and low costs are required.

Schematic with Off-Chip Components

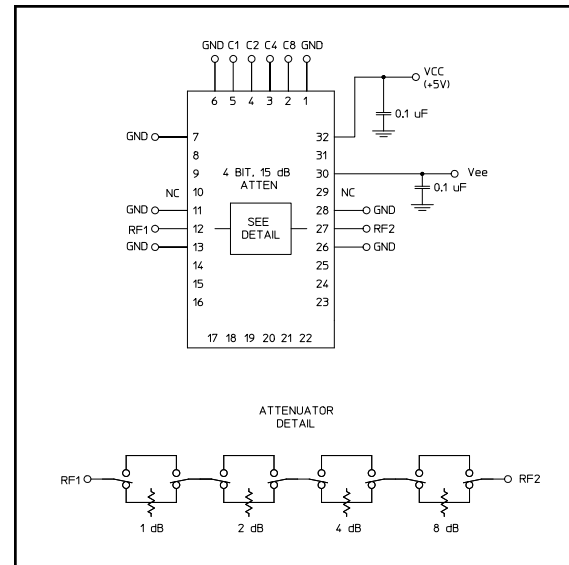

Pin Configuration²

Pin No.	Function	Pin No.	Function
1	GND	17	N/C
2	C8	18	N/C
3	C4	19	N/C
4	C2	20	N/C
5	C1	21	N/C
6	GND	22	N/C
7	GND	23	N/C
8	N/C	24	N/C
9	N/C	25	N/C
10	N/C ¹	26	GND
11	GND	27	RF2
12	RF1	28	GND
13	GND	29	N/C ¹
14	N/C	30	-Vee
15	N/C	31	N/C
16	N/C	32	+Vcc

1. Pins 10 & 29 must be isolated.
2. The exposed pad centered on the package bottom must be connected to RF and DC ground. (For PQFN Packages)

Ordering Information

Part Number	Package
AT90-0413	Bulk Packaging
AT90-0413TR	1000 piece reel
AT90-0413-TB	Sample Test Board

Note: Reference Application Note M513 for reel size information.

ADVANCED: Data Sheets contain information regarding a product M/A-COM Technology Solutions is considering for development. Performance is based on target specifications, simulated results, and/or prototype measurements. Commitment to develop is not guaranteed.
PRELIMINARY: Data Sheets contain information regarding a product M/A-COM Technology Solutions has under development. Performance is based on engineering tests. Specifications are typical. Mechanical outline has been fixed. Engineering samples and/or test data may be available. Commitment to produce in volume is not guaranteed.

• **North America** Tel: 800.366.2266 • **Europe** Tel: +353.21.244.6400
 • **India** Tel: +91.80.4155721 • **China** Tel: +86.21.2407.1588
 Visit www.macomtech.com for additional data sheets and product information.

M/A-COM Technology Solutions Inc. and its affiliates reserve the right to make changes to the product(s) or information contained herein without notice.

Electrical Specifications: $T_A = 25^\circ\text{C}$

Parameter	Test Conditions	Frequency	Units	Min	Typ	Max
Insertion Loss	—	DC-2.5 GHz	dB	—	2.0	2.5
		DC-4.0 GHz	dB	—	2.5	3.0
Attenuation Accuracy	Individual Bits or Combination of Bits	DC-2.5 GHz	dB	—	—	$\pm(0.3+4\%$ of atten setting)
		DC-4.0 GHz	dB	—	—	$\pm(0.3+6\%$ of atten setting)
VSWR	Full Attenuation Range	DC-2.5 GHz	Ratio	—	1.5:1	1.8:1
		DC-4.0 GHz	Ratio	—	1.8:1	2.0:1
Switching Speed	50% Cntl to 90%/10% RF 10% to 90% or 90% to 10%	—	nS	—	75	150
		—	nS	—	20	50
1 dB Compression	—	50 MHz	dB	—	+21	—
		0.5-4.0 GHz	dB	—	+29	—
Input IP_3	Two-tone Inputs up to +5 dBm	50 MHz	dB	—	+35	—
		0.5-4.0 GHz	dB	—	+48	—
+Vcc	—	—	V	4.75	5.0	5.25
-Vee	—	—	V	-8.0	-5.0	-4.75
V_{IL} V_{IH}	LOW-level input voltage HIGH-level input voltage	—	V	0.0	—	0.8
		—	V	2.0	—	5.0
I_{in} (Input Leakage Current)	$V_{in} = V_{CC}$ or GND	—	μA	-1.0	—	1.0
I_{cc} (Quiescent Supply Current)	$V_{cntrl} = V_{CC}$ or GND	—	μA	—	250	400
ΔI_{cc} (Additional Supply Current Per TTL Input Pin)	$V_{CC} = \text{Max}$, $V_{cntrl} = V_{CC} - 2.1\text{ V}$	—	mA	—	—	1.0
IEE	V_{EE} min to max, $V_{in} = V_{IL}$ or V_{IH}	—	mA	-1.0	-0.2	—
Thermal Resistance θ_{jc}	—	—	$^\circ\text{C/W}$	—	15	—

Absolute Maximum Ratings^{3,4}

Parameter	Absolute Maximum
Max. Input Power 0.05 GHz 0.5 - 4.0 GHz	+27 dBm +34 dBm
V_{CC}	$-0.5\text{ V} \leq V_{CC} \leq +7.0\text{ V}$
V_{EE}	$-8.5\text{ V} \leq V_{EE} \leq +0.5\text{ V}$
$V_{CC} - V_{EE}$	$-0.5\text{ V} \leq V_{CC} - V_{EE} \leq 14.5\text{ V}$
V_{in}^5	$-0.5\text{ V} \leq V_{in} \leq V_{CC} + 0.5\text{ V}$
Operating Temperature	-40°C to $+85^\circ\text{C}$
Storage Temperature	-65°C to $+125^\circ\text{C}$

- Exceeding any one or combination of these limits may cause permanent damage to this device.
- M/A-COM does not recommend sustained operation near these survivability limits.
- Standard CMOS TTL interface, latch-up will occur if logic signal applied prior to power supply.

Recommended PCB Configuration⁶

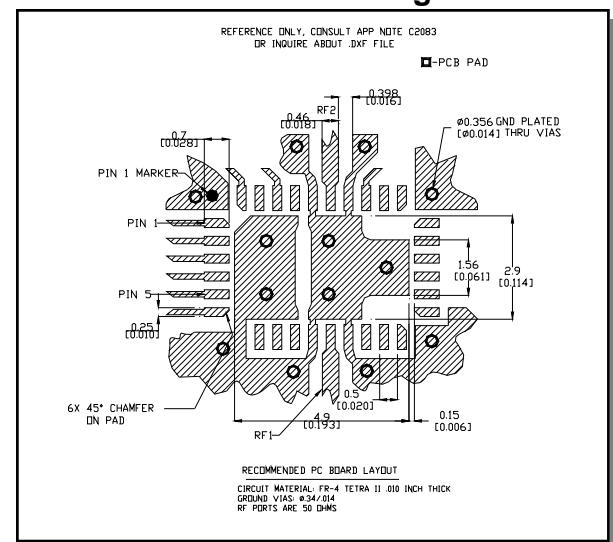

- Application Note S2083 is available on line at www.macom.com

Handling Procedures

Please observe the following precautions to avoid damage:

Static Sensitivity

Gallium Arsenide Integrated Circuits are sensitive to electrostatic discharge (ESD) and can be damaged by static electricity. Proper ESD control techniques should be used when handling these devices.

Moisture Sensitivity

The MSL rating for this part is defined as Level 2 per IPC/JEDEC J-STD-020. Parts shall be stored and/or baked as required for MSL Level 2 parts.

Truth Table (Digital Attenuator)

C8	C4	C2	C1	Attenuation
0	0	0	0	Loss, Reference
0	0	0	1	1.0 dB
0	0	1	0	2.0 dB
0	1	0	0	4.0 dB
1	0	0	0	8.0 dB
1	1	1	1	15.0 dB

0 = TTL Low. 1 = TTL High

Typical Performance Curves

Insertion Loss

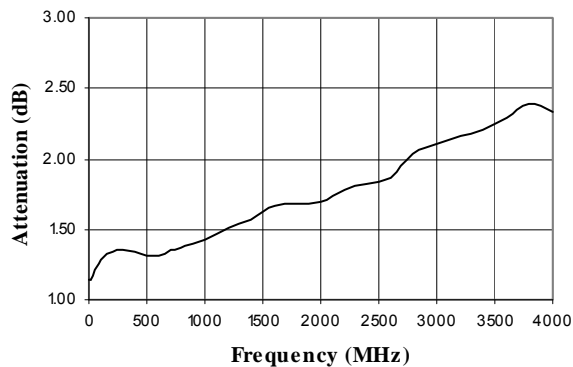

VSWR @ Insertion Loss

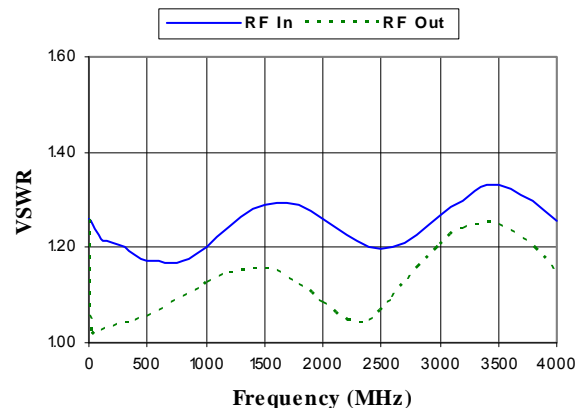

Typical Performance Curves

Attenuation Error, 1 dB Bit

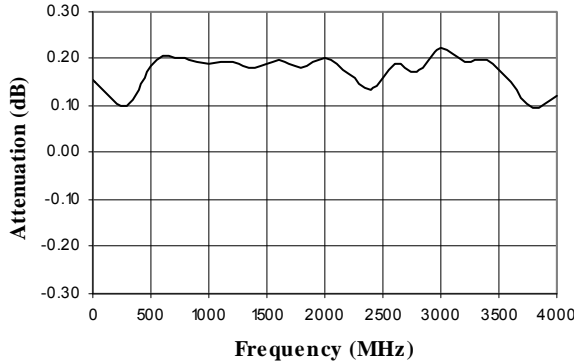

Attenuation Error, 2 dB Bit

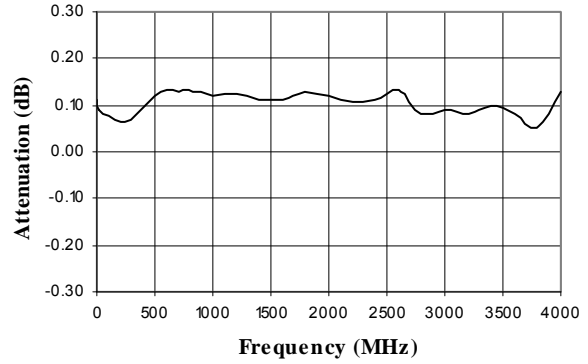

Attenuation Error, 4 dB Bit

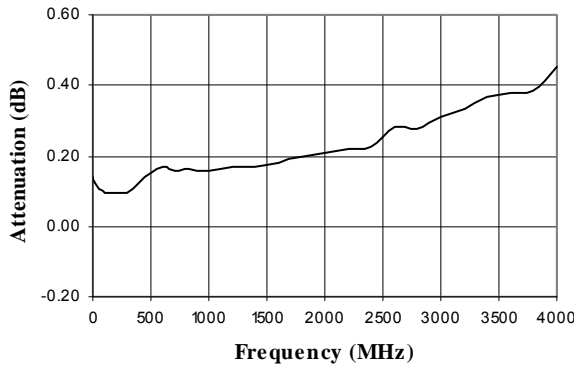

Attenuation Error, 8 dB Bit

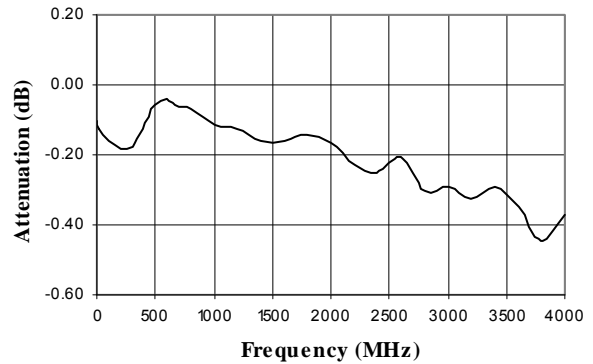

Attenuation Error, Max. Attenuation

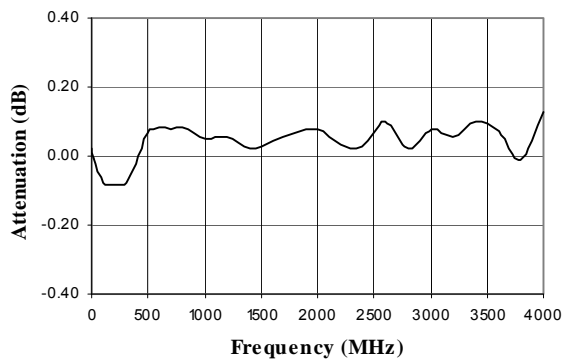

VSWR, 1 dB Bit

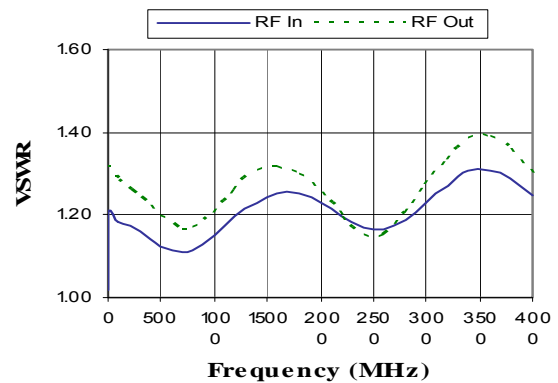

Typical Performance Curves

VSWR, 2 dB Bit

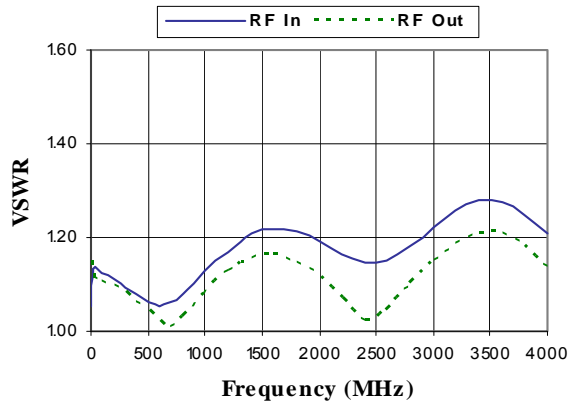

VSWR, 4 dB Bit

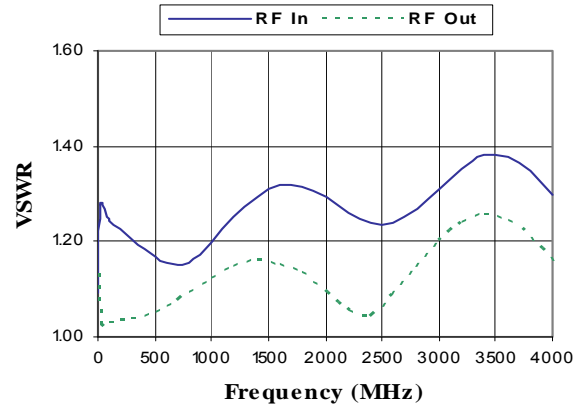

VSWR, 8 dB Bit

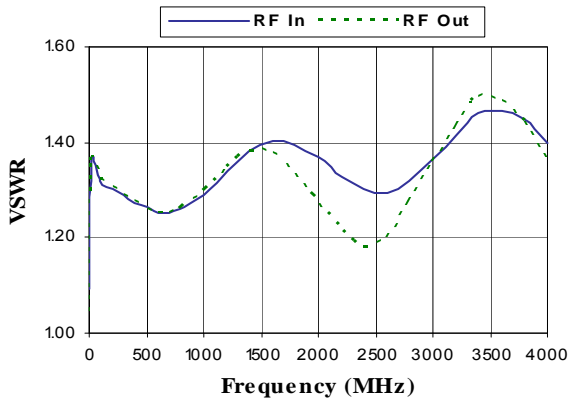

VSWR, Max. Attenuation

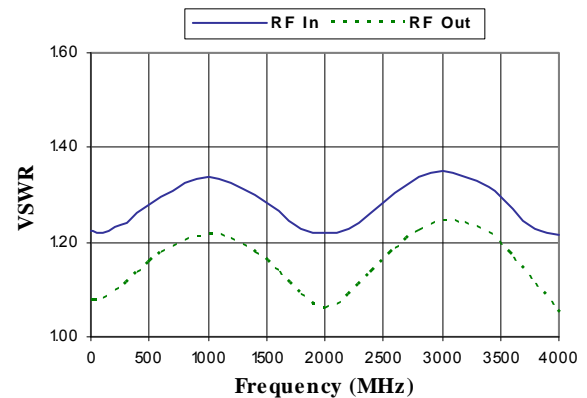

Insertion Loss vs. Temperature

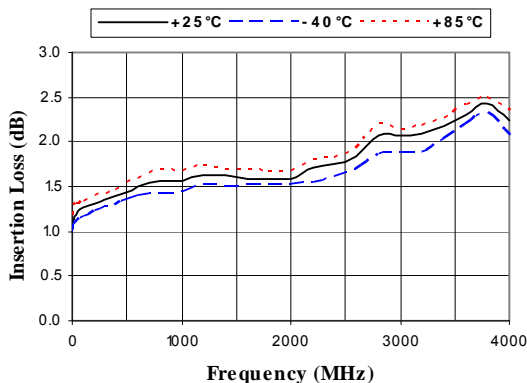

1 dB Bit vs. Temperature

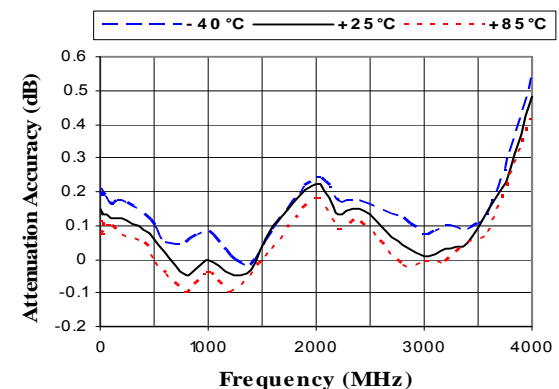

Typical Performance Curves

2 dB Bit vs. Temperature

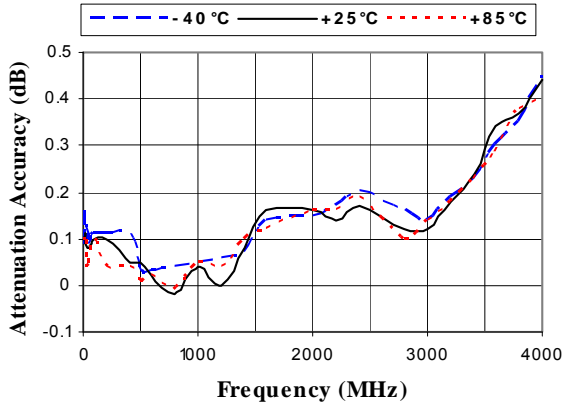

4 dB Bit vs. Temperature

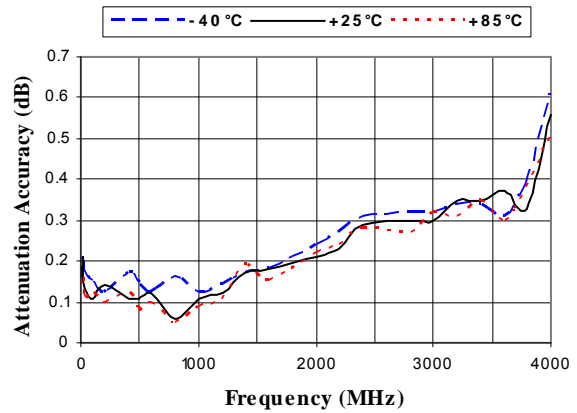

8 dB Bit vs. Temperature

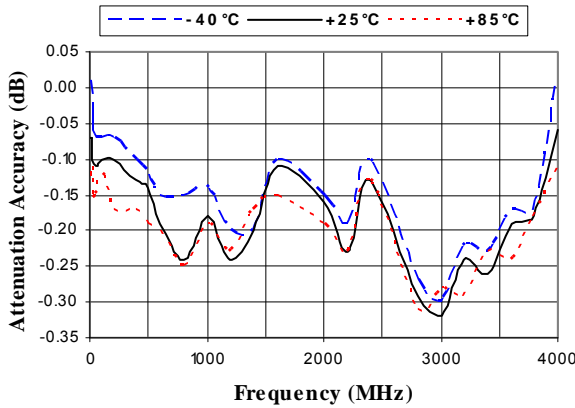

Max. Attenuation vs. Temperature

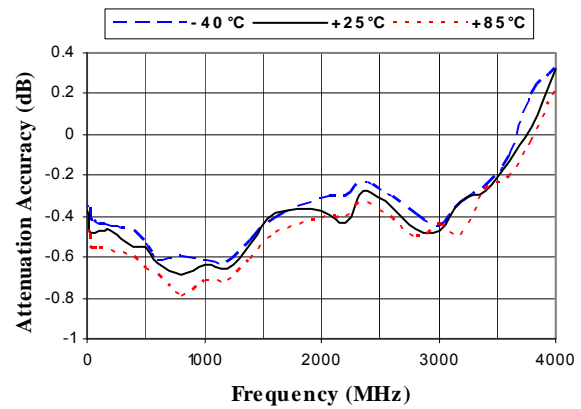

Компания «Life Electronics» занимается поставками электронных компонентов импортного и отечественного производства от производителей и со складов крупных дистрибьюторов Европы, Америки и Азии.

С конца 2013 года компания активно расширяет линейку поставок компонентов по направлению коаксиальный кабель, кварцевые генераторы и конденсаторы (керамические, пленочные, электролитические), за счёт заключения дистрибьюторских договоров

Мы предлагаем:

- Конкурентоспособные цены и скидки постоянным клиентам.
- Специальные условия для постоянных клиентов.
- Подбор аналогов.
- Поставку компонентов в любых объемах, удовлетворяющих вашим потребностям.
- Приемлемые сроки поставки, возможна ускоренная поставка.
- Доставку товара в любую точку России и стран СНГ.
- Комплексную поставку.
- Работу по проектам и поставку образцов.
- Формирование склада под заказчика.
- Сертификаты соответствия на поставляемую продукцию (по желанию клиента).
- Тестирование поставляемой продукции.
- Поставку компонентов, требующих военную и космическую приемку.
- Входной контроль качества.
- Наличие сертификата ISO.

В составе нашей компании организован Конструкторский отдел, призванный помогать разработчикам, и инженерам.

Конструкторский отдел помогает осуществить:

- Регистрацию проекта у производителя компонентов.
- Техническую поддержку проекта.
- Защиту от снятия компонента с производства.
- Оценку стоимости проекта по компонентам.
- Изготовление тестовой платы монтаж и пусконаладочные работы.



Тел: +7 (812) 336 43 04 (многоканальный)

Email: org@lifeelectronics.ru