

GENERAL DESCRIPTION

The MLO™ SMT RF-RF Crossover is a very low profile crossover that intersects an RF and RF circuit trace in an SMT package. The RF-RF Crossover is a low cost solution for applications where a critical RF circuit trace intersects a RF circuit precluding the need for an expensive multilayer printed circuit board. The SMT package can support frequencies up to 6 GHz. MLO™ crossovers have been subjected to JEDEC reliability standards and 100% electrically tested. The RF-RF crossovers are available in NiSn.

FEATURES

- DC – 6.0 GHz
- RF – RF Crossover
- Low Loss
- High Isolation
- Surface Mountable
- Tape and Reel
- 100% Tested

APPLICATIONS

- Mobile communications
- GPS
- Vehicle location systems
- Wireless LAN's

LAND GRID ARRAY ADVANTAGES

- Inherent Low Profile
- Excellent Solderability
- Low Parasitics
- Better Heat Dissipation

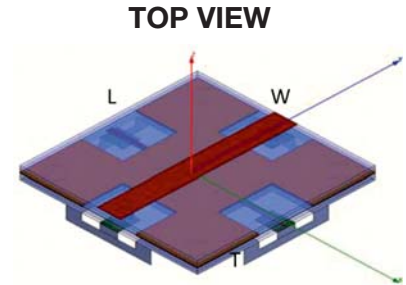

HOW TO ORDER

X2B

Series

2020

Size

RFRF

Type

T

Packaging

T = 1000pcs T&R
T/250 = 250pcs T&R
B = Bulk

Frequency (GHz)	Port Impedance (ohms)	Ins. Loss (dB max)	Return Loss (dB min)	Isolation (dB min)	Power (Watts)	θJC (°C /Watts)	Operating Temperature (°C)
DC -2.5	50	0.05	20	50	30	150	-55 to +85
2.5 – 4.0	50	0.10	18	30	19	150	-55 to +85
4.0 – 6.0	50	0.15	10	20	9	150	-55 to +85

* Specification based on performance of component assembled properly on printed circuit board with 50Ω nominal impedance.

QUALITY INSPECTION

Finished parts are 100% tested for electrical parameters and visual characteristics.

TERMINATION

NiSn compatible with automatic soldering technologies: Pb free reflow, wave soldering, vapor phase and manual.

OPERATING TEMPERATURE

- 55°C to +85°C

MECHANICAL OUTLINE

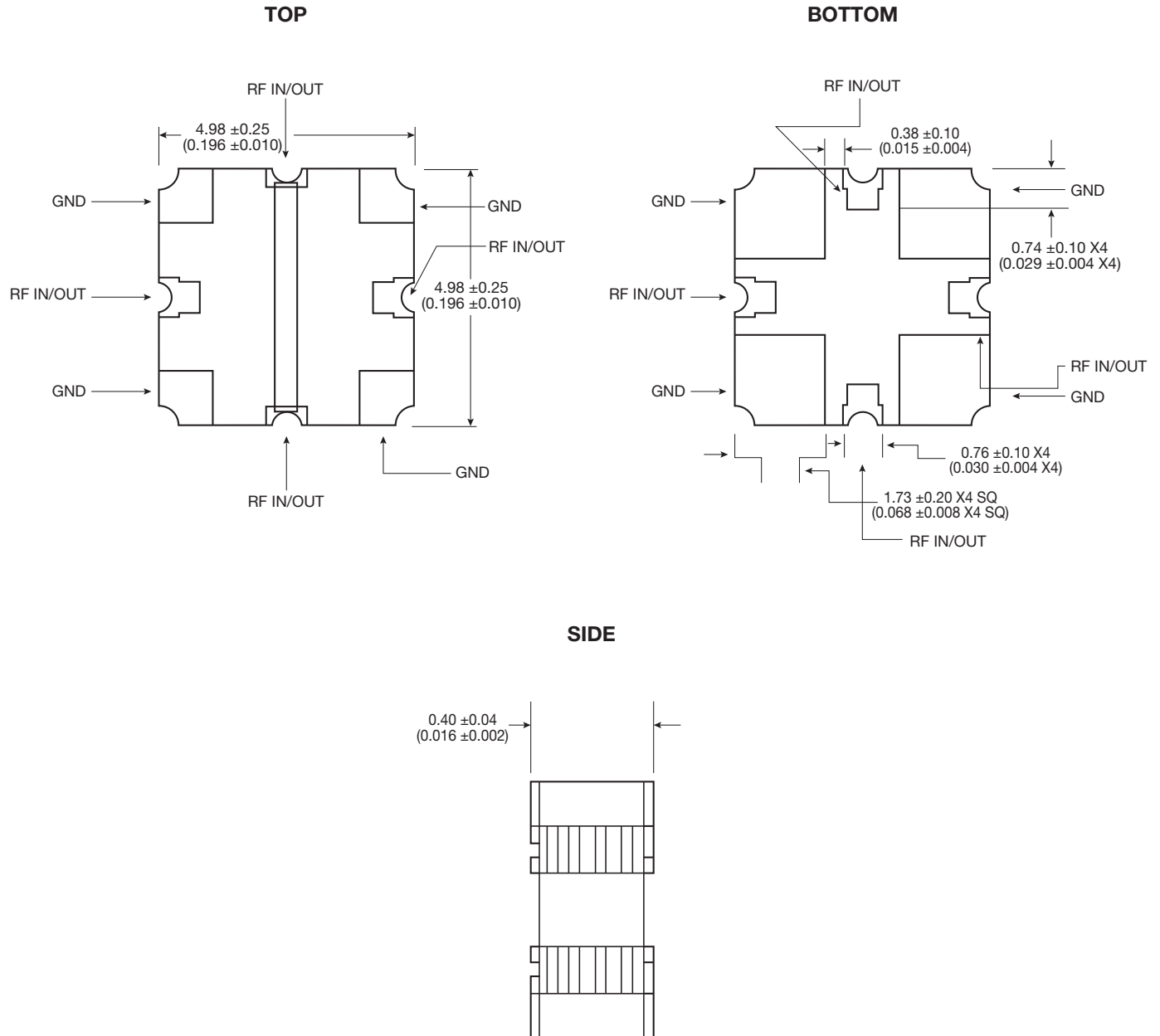

RF-RF SMT CROSSOVER PERFORMANCE: 0.3 GHZ TO 6 GHZ

RF/RF Crossover – Insertion Loss

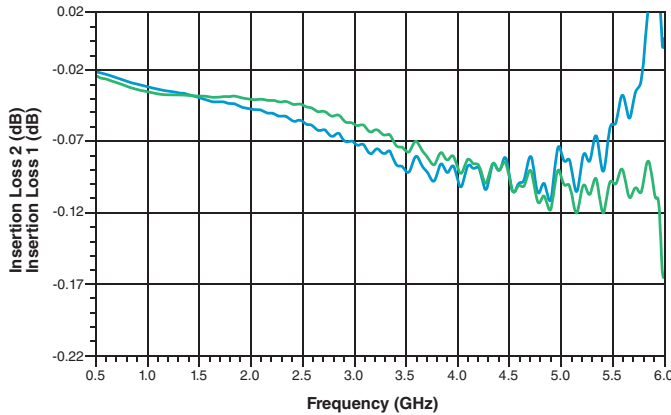

RF/RF Crossover – Return Loss

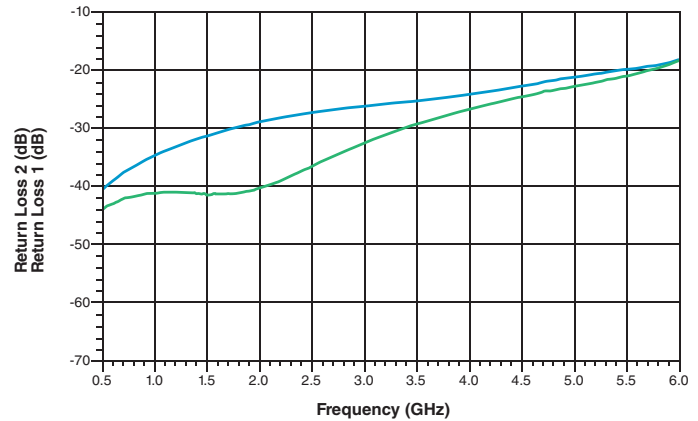

RF/RF Crossover – Isolation

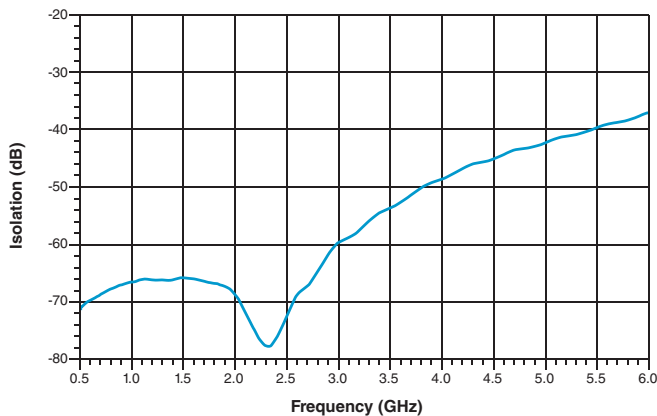

RF/RF Crossover – Phase Balance

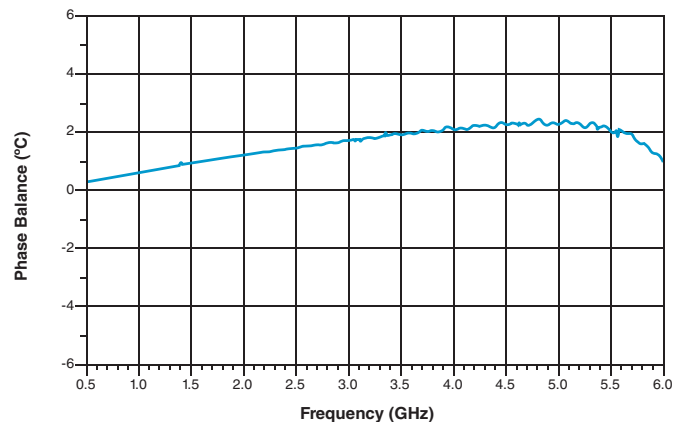

MOUNTING PROCEDURE

MLO™ SMT crossovers require 50Ω transmission lines leading to and from all of the RF ports. Proper grounding is required in order to ensure optimal device performance. If these conditions are not met then performance parameters including insertion loss, return loss and any isolation may not meet published values. All of the MLO™ components utilize castellated interconnects which allow for high yield assembly, expansion matched and halogen free dielectric. When mounting the user must be mindful of the following: a) ensure the RF pads of the device are in contact with the circuit trace of the printed circuit board and b) the ground plane of neither the component nor the PCB is in contact with the RF signal. Parts are specifically oriented in the tape and reel.

MOUNTING FOOTPRINT

To ensure proper electrical and thermal performance there must be a ground plane with 100% solder connection underneath the part.

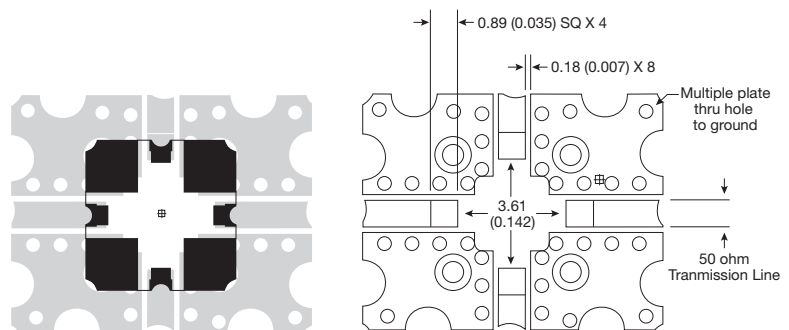

Dimensions are in mm (inches)

AUTOMATED SMT ASSEMBLY

The following section describes the guidelines for automated SMT assembly of MLO™ RF devices which are typically Land Grid Array (LGA) packages or side termination SMT packages.

Control of solder and solder paste volume is critical for

surface mount assembly of MLO™ RF devices onto the PCB. Stencil thickness and aperture openings should be adjusted according to the optimal solder volume. The following are general recommendations for SMT mounting of MLO™ devices onto the PCB.

SMT REFLOW PROFILE

Common IR or convection reflow SMT processes shall be used for the assembly. Standard SMT reflow profiles, for eutectic and Pb free solders, can be used to surface mount the MLO™ devices onto the PCB. In all cases, a temperature gradient of 3°C/sec, or less, should be maintained to prevent warpage of the package and to ensure that all joints reflow properly. Additional soak time

and slower preheating time may be required to improve the out-gassing of solder paste. In addition, the reflow profile depends on the PCB density and the type of solder paste used. Standard no-clean solder paste is generally recommended. If another type of flux is used, complete removal of flux residual may be necessary. Example of a typical lead free reflow profile is shown below:

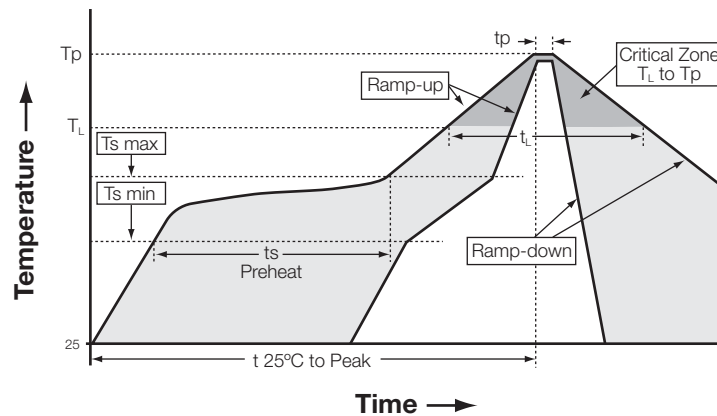

Profile Parameter	Pb free, Convection, IR/Convection
Ramp-up rate (T _s max to T _p)	3°C/second max.
Preheat temperature (T _s min to T _s max)	150°C to 200°C
Preheat time (t _s)	60 – 180 seconds
Time above T _L , 217°C (t _L)	60 – 120 seconds
Peak temperature (T _p)	260°C
Time within 5°C of peak temperature (t _p)	10 – 20 seconds
Ramp-down rate	4°C/second max.
Time 25°C to peak temperature	6 minutes max.

Компания «Life Electronics» занимается поставками электронных компонентов импортного и отечественного производства от производителей и со складов крупных дистрибьюторов Европы, Америки и Азии.

С конца 2013 года компания активно расширяет линейку поставок компонентов по направлению коаксиальный кабель, кварцевые генераторы и конденсаторы (керамические, пленочные, электролитические), за счёт заключения дистрибьюторских договоров

Мы предлагаем:

- Конкурентоспособные цены и скидки постоянным клиентам.
- Специальные условия для постоянных клиентов.
- Подбор аналогов.
- Поставку компонентов в любых объемах, удовлетворяющих вашим потребностям.
- Приемлемые сроки поставки, возможна ускоренная поставка.
- Доставку товара в любую точку России и стран СНГ.
- Комплексную поставку.
- Работу по проектам и поставку образцов.
- Формирование склада под заказчика.
- Сертификаты соответствия на поставляемую продукцию (по желанию клиента).
- Тестирование поставляемой продукции.
- Поставку компонентов, требующих военную и космическую приемку.
- Входной контроль качества.
- Наличие сертификата ISO.

В составе нашей компании организован Конструкторский отдел, призванный помогать разработчикам, и инженерам.

Конструкторский отдел помогает осуществить:

- Регистрацию проекта у производителя компонентов.
- Техническую поддержку проекта.
- Защиту от снятия компонента с производства.
- Оценку стоимости проекта по компонентам.
- Изготовление тестовой платы монтаж и пусконаладочные работы.



Тел: +7 (812) 336 43 04 (многоканальный)

Email: org@lifeelectronics.ru