

MLX90333 Position Sensor

Datasheet

Features and Benefits

- Absolute 3D Position Sensor
- Simple & Robust Magnetic Design
- Tria \otimes is $^{\text{®}}$ Hall Technology
- Programmable Linear Transfer Characteristics (Alpha, Beta)
- Selectable Analog (Ratiometric), PWM, Serial Protocol
- 12 bit Angular Resolution - 10 bit Angular Thermal Accuracy
- 40 bit ID Number
- Single Die – SOIC-8 Package RoHS Compliant
- Dual Die (Full Redundant) – TSSOP-16 Package RoHS Compliant



SOIC-8

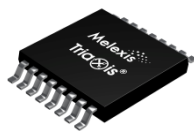

TSSOP-16

Applications

- 3D Position Sensor
- Joystick
- 4-Way Scroll Key
- Joypad
- Man Machine Interface Device
- Linear Position Sensor

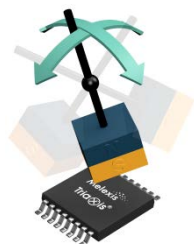
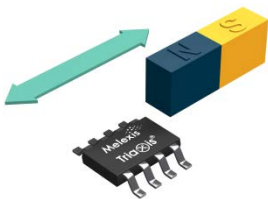

Description

The MLX90333 is a Tria \otimes is $^{\text{®}}$ Position Sensor able to sense any magnet moving in its surrounding through the measurement and the processing of the 3 spatial components of the magnetic flux density vector (i.e. B_x , B_y and B_z).

The horizontal components (B_x and B_y) are sensed thanks to an Integrated Magneto-Concentrator (IMC) while the vertical component (B_z) is sensed through conventional Hall plate.

The MLX90333 features a contactless position sensor mode suitable for rotary position sensor (through-shaft magnet), linear stroke position sensor (magnet displacement parallel to the device surface) and for 3D/"Joystick" position sensor.

The processed position information is ultimately reported as a ratiometric analog output or as PWM (Pulse-Width Modulation) signal. In case of 3D/"Joystick" mode, the device features 2 independent outputs. A 3-pin SPI (serial interface) mode is also available to transfer the position information to a host-controller.

The output transfer characteristic is fully programmable (e.g. offset, gain, clamping levels, linearity, thermal drift, filtering, range...) to match any specific requirement through end-of-line calibration. The Melexis programming unit PTC-04 communicates and calibrates the device exclusively through the connector terminals (VDD-VSS-OUT).

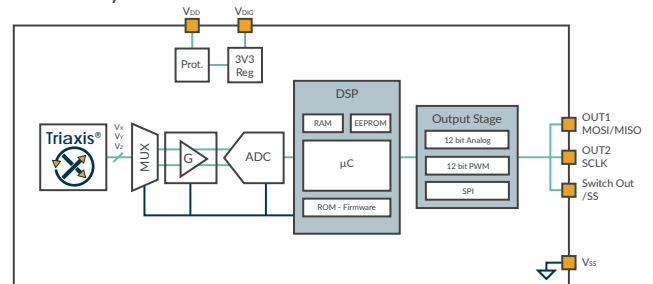

Contents

| | |
|---------------------------------------------------------------------|----|
| Features and Benefits..... | 1 |
| Applications | 1 |
| Description | 1 |
| 1. Ordering Information | 5 |
| 2. Functional Diagram | 6 |
| 3. Glossary of Terms | 7 |
| 4. Pinout | 8 |
| 5. Absolute Maximum Ratings..... | 9 |
| 6. Electrical Specification..... | 10 |
| 7. Isolation Specification..... | 12 |
| 8. Timing Specification..... | 12 |
| 9. Accuracy Specification..... | 13 |
| 10. Magnetic Specification | 15 |
| 11. CPU & Memory Specification | 15 |
| 12. End-User Programmable Items | 16 |
| 13. Description of End-User Programmable Items..... | 19 |
| 13.1. Output Configuration..... | 19 |
| 13.2. Output Mode | 19 |
| 13.2.1. Analog Output Mode | 19 |
| 13.2.2. PWM Output Mode | 20 |
| 13.2.3. Serial Protocol Output Mode..... | 20 |
| 13.2.4. Switch Out..... | 21 |
| 13.3. Output Transfer Characteristic | 21 |
| 13.3.1. The Polarity and Modulo Parameters..... | 22 |
| 13.3.2. Alpha/Beta Discontinuity Point (or Zero Degree Point) | 23 |
| 13.3.3. LNR Parameters | 23 |
| 13.3.4. CLAMPING Parameters | 24 |
| 13.3.5. DEADZONE Parameter | 24 |
| 13.4. Identification | 25 |
| 13.5. Sensor Front-End | 25 |
| 13.5.1. HIGHSPEED Parameter..... | 26 |

- 13.5.2. GAINMIN and GAINMAX Parameters 26
- 13.5.3. FIELDTHRES_LOW and FIELDTHRES_HIGH Parameters 26
- 13.6. FILTER 27
 - 13.6.1. Hysteresis Filter..... 27
 - 13.6.2. FIR Filters..... 27
 - 13.6.3. IIR Filters..... 29
- 13.7. Programmable Enhanced “Joystick’ Angle Correction 30
 - 13.7.1. Enhanced “Joystick” Angle Formula 30
- 13.8. Programmable Diagnostic Settings..... 30
 - 13.8.1. OUTxDIAG Parameter 31
 - 13.8.2. RESONFAULT Parameter 31
 - 13.8.3. EEHAMHOLE Parameter 31
- 13.9. Lock 31
 - 13.9.1. MLXLOCK Parameter..... 31
 - 13.9.2. LOCK Parameter 31
- 14. Self Diagnostic 32**
- 15. Serial Protocol 35**
 - 15.1. Introduction 35
 - 15.2. SERIAL PROTOCOL Mode 35
 - 15.3. MOSI (Master Out Slave In) 35
 - 15.4. MISO (Master In Slave Out) 35
 - 15.5. /SS (Slave Select)..... 35
 - 15.6. Master Start-Up 35
 - 15.7. Slave Start-Up 36
 - 15.8. Timing..... 36
 - 15.9. Slave Reset 37
 - 15.10. Frame Layer 37
 - 15.10.1. Frame Type Selection 37
 - 15.10.2. Data Frame Structure 37
 - 15.10.3. Timing..... 38
 - 15.10.4. Data Structure 38
 - 15.10.5. Angle Calculation 39
 - 15.10.6. Error Handling..... 39

| | |
|--------------------------------------------------------------------------------------------------------------------------|-----------|
| 16. Recommended Application Diagrams | 40 |
| 16.1. Analog Output Wiring in SOIC-8 Package | 40 |
| 16.2. PWM Low Side Output Wiring | 40 |
| 16.3. Analog Output Wiring in TSSOP-16 Package | 41 |
| 16.4. Serial Protocol | 42 |
| 17. Standard information regarding manufacturability of Melexis products with different soldering processes | 43 |
| 18. ESD Precautions | 43 |
| 19. Package Information | 44 |
| 19.1. SOIC-8 - Package Dimensions | 44 |
| 19.2. SOIC-8 - Pinout and Marking | 44 |
| 19.3. SOIC-8 - IMC Positioning | 45 |
| 19.4. TSSOP-16 - Package Dimensions | 46 |
| 19.5. TSSOP-16 - Pinout and Marking..... | 47 |
| 19.6. TSSOP-16 - IMC Positioning | 47 |
| 20. Disclaimer | 48 |
| 21. Contact | 48 |

1. Ordering Information

| Product Code | Temperature Code | Package Code | Option Code | Packing Form Code |
|--------------|------------------|--------------|-------------|-------------------|
| MLX90333 | S | DC | BCH-000 | RE |
| MLX90333 | E | DC | BCH-000 | RE |
| MLX90333 | E | DC | BCH-100 | RE |
| MLX90333 | E | DC | BCT-000 | RE |
| MLX90333 | K | DC | BCH-000 | RE |
| MLX90333 | K | DC | BCH-100 | RE |
| MLX90333 | K | DC | BCT-000 | RE |
| MLX90333 | L | DC | BCH-000 | RE |
| MLX90333 | L | DC | BCH-100 | RE |
| MLX90333 | L | DC | BCT-000 | RE |
| MLX90333 | E | GO | BCH-000 | RE |
| MLX90333 | E | GO | BCH-100 | RE |
| MLX90333 | E | GO | BCT-000 | RE |
| MLX90333 | K | GO | BCH-000 | RE |
| MLX90333 | K | GO | BCH-100 | RE |
| MLX90333 | K | GO | BCT-000 | RE |
| MLX90333 | L | GO | BCH-000 | RE |
| MLX90333 | L | GO | BCH-100 | RE |
| MLX90333 | L | GO | BCT-000 | RE |

Legend:

| | |
|-------------------|------------------------------------------------------------------------------------------------------------------------------------|
| Temperature Code: | S: from -20 Deg.C to 85 Deg.C E: from -40 Deg.C to 85 Deg.C K: from -40 Deg.C to 125 Deg.C L: from -40 Deg.C to 150 Deg.C |
| Package Code: | “DC” for SOIC-8 package “GO” for TSSOP-16 package (dual die) |
| Option Code: | AAA-xxx: die version xxx-000: Standard xxx-100: SPI |
| Packing Form: | “RE” for Reel “TU” for Tube |
| Ordering Example: | MLX90333LGO-BCH-000-RE |

Table 1 - Legend

2. Functional Diagram

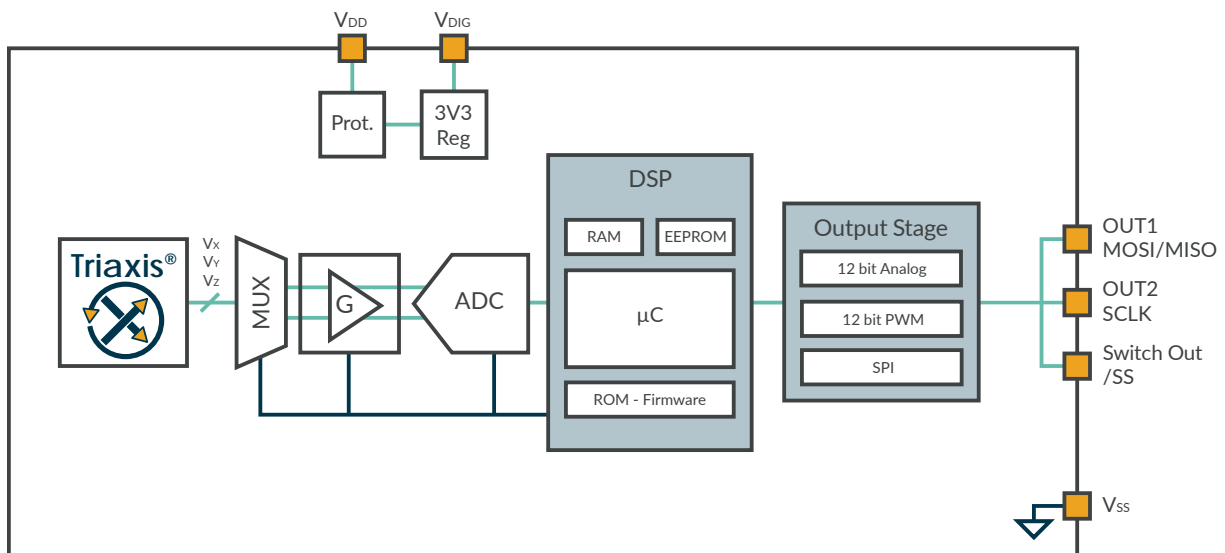

Figure 1 – Block Diagram

3. Glossary of Terms

| | |
|----------------------|--------------------------------------------------------------------------------------|
| Gauss (G), Tesla (T) | Units for the magnetic flux density - 1 mT = 10 G |
| TC | Temperature Coefficient (in ppm/Deg.C.) |
| NC | Not Connected |
| PWM | Pulse Width Modulation |
| %DC | Duty Cycle of the output signal i.e. $T_{ON} / (T_{ON} + T_{OFF})$ |
| ADC | Analog-to-Digital Converter |
| DAC | Digital-to-Analog Converter |
| LSB | Least Significant Bit |
| MSB | Most Significant Bit |
| DNL | Differential Non-Linearity |
| INL | Integral Non-Linearity |
| RISC | Reduced Instruction Set Computer |
| ASP | Analog Signal Processing |
| DSP | Digital Signal Processing |
| ATAN | Trigonometric function: arctangent (or inverse tangent) |
| IMC | Integrated Magneto-Concentrator (IMC®) |
| CoRDIC | Coordinate Rotation Digital Computer (i.e. iterative rectangular-to-polar transform) |
| EMC | Electro-Magnetic Compatibility |

Table 2 – Glossary of Terms

4. Pinout ⁽¹⁾

| PIN | SOIC-8 | | TSSOP-16 | |
|-----|--------------|-----------------|-----------------------------------------|-----------------------------------------|
| | Analog / PWM | Serial Protocol | Analog / PWM | Serial Protocol |
| 1 | VDD | VDD | VDIG ₁ | VDIG ₁ |
| 2 | Test 0 | Test 0 | VSS ₁ (Ground ₁) | VSS ₁ (Ground ₁) |
| 3 | Not Used | /SS | VDD ₁ | VDD ₁ |
| 4 | OUT2 | SCLK | Test 0 ₁ | Test 0 ₁ |
| 5 | OUT1 | MOSI / MISO | Not Used | /SS ₂ |
| 6 | Test 1 | Test 1 | OUT2 ₂ | SCLK ₂ |
| 7 | VDIG | VDIG | OUT1 ₂ | MOSI ₂ / MISO ₂ |
| 8 | Vss (Ground) | Vss (Ground) | Test 1 ₂ | Test 1 ₂ |
| 9 | | | VDIG ₂ | VDIG ₂ |
| 10 | | | VSS ₂ (Ground ₂) | VSS ₂ (Ground ₂) |
| 11 | | | VDD ₂ | VDD ₂ |
| 12 | | | Test 0 ₂ | Test 0 ₂ |
| 13 | | | Not Used | /SS ₁ |
| 14 | | | OUT2 ₁ | SCLK ₁ |
| 15 | | | OUT1 ₁ | MOSI ₁ / MISO ₁ |
| 16 | | | Test 1 ₁ | Test 1 ₁ |

For optimal EMC behavior, it is recommended to connect the unused pins (Not Used and Test) to the Ground (see section 16).

¹ See Section 13.1 for OUT1 and OUT2 configuration

5. Absolute Maximum Ratings

| Parameter | Value |
|-----------------------------------------------------------------------|------------------------------------------------------------|
| Supply Voltage, V _{DD} (overvoltage) | + 20 V |
| Reverse Voltage Protection | - 10 V |
| Positive Output Voltage (Analog or PWM) Both Outputs OUT1 and OUT2 | + 10 V + 14 V (200 s max – T _A = + 25 Deg.C) |
| Output Current (I _{OUT}) | ± 30 mA |
| Reverse Output Voltage Both Outputs OUT1 and OUT2 | - 0.3 V |
| Reverse Output Current Both Outputs OUT1 and OUT2 | - 50 mA |
| Operating Ambient Temperature Range, T _A | - 40 Deg.C ... + 150 Deg.C |
| Storage Temperature Range, T _S | - 40 Deg.C ... + 150 Deg.C |
| Magnetic Flux Density | ± 4 T |

Exceeding the absolute maximum ratings may cause permanent damage. Exposure to absolute maximum-rated conditions for extended periods may affect device reliability.

6. Electrical Specification

DC Operating Parameters at $V_{DD} = 5V$ (unless otherwise specified) and for T_A as specified by the Temperature suffix (S, E, K or L).

| Parameter | Symbol | Test Conditions | Min | Typ | Max | Units |
|---------------------------------------------------------------|----------------|-------------------------------------------------------------------------------------------|----------|------|-------------------------|--------------------------|
| Nominal Supply Voltage | V_{DD} | | 4.5 | 5 | 5.5 | V |
| Supply Current ⁽²⁾ | I_{DD} | Slow mode ⁽³⁾ | | 8.5 | 11 | mA |
| | | Fast mode ⁽³⁾ | | 13.5 | 16 | mA |
| POR Level | V_{DD} POR | Supply Under Voltage | 2 | 2.7 | 3 | V |
| Output Current Both Outputs OUT1 and OUT2 | I_{OUT} | Analog Output mode | -8 | | 8 | mA |
| | | PWM Output mode | -20 | | 20 | mA |
| Output Short Circuit Current Both Outputs OUT1 and OUT2 | I_{short} | $V_{OUT} = 0 V$ | | 12 | 15 | mA |
| | | $V_{OUT} = 5 V$ | | 12 | 15 | mA |
| | | $V_{OUT} = 14 V (T_A = 25 \text{ Deg.C})$ | | 24 | 45 | mA |
| Output Load Both Outputs OUT1 and OUT2 | R_L | Pull-down to Ground | 1 | 10 | ∞ ⁽⁵⁾ | k Ω |
| | | Pull-up to 5V ⁽⁴⁾ | 1 | 10 | ∞ ⁽⁵⁾ | k Ω |
| Analog Saturation Output Level Both Outputs OUT1 and OUT2 | V_{sat_lo} | Pull-up load $R_L \geq 10 \text{ k}\Omega$ | | | 3 | % V_{DD} |
| | V_{sat_hi} | Pull-down load $R_L \geq 5 \text{ k}\Omega$ | 96 | | | % V_{DD} |
| Digital Saturation Output Level Both Outputs OUT1 and OUT2 | V_{satD_lo} | Pull-up Low Side $R_L \geq 10 \text{ k}\Omega$ Push-Pull ($I_{OUT} = -20\text{mA}$) | | | 1.5 | % V_{DD} |
| | V_{satD_hi} | Push-Pull ($I_{OUT} = 20\text{mA}$) | 97 | | | % V_{DD} |
| Active Diagnostic Output Level Both Outputs OUT1 and OUT2 | $Diag_lo$ | Pull-down load $R_L \geq 5 \text{ k}\Omega$ Pull-up load $R_L \geq 10 \text{ k}\Omega$ | | | 1 1.5 | % V_{DD} % V_{DD} |
| | $Diag_hi$ | Pull-down load $R_L \geq 5 \text{ k}\Omega$ Pull-up load $R_L \geq 5 \text{ k}\Omega$ | 96 98 | | | % V_{DD} % V_{DD} |
| Passive Diagnostic Output Level | BV_{SSPD} | Broken VSS & Pull-down load $R_L \leq 10 \text{ k}\Omega$ | | | 4 ⁽⁶⁾ | % V_{DD} |

² Supply current per silicon die. Dual die version will consume twice the current

³ See section 13.5.1 for details concerning Slow and Fast mode

⁴ Applicable for output in Analog and PWM (Open-Drain) mode

⁵ $R_L < \infty$ for output in PWM mode

| Parameter | Symbol | Test Conditions | Min | Typ | Max | Units |
|------------------------------------------------------------------------|----------|-------------------------------------------------------------|-------------------------------|-----|-----|-------|
| Both Outputs OUT1 and OUT2 (Broken Track Diagnostic) ⁽⁶⁾ | BVSSPU | Broken VSS & Pull-up load $R_L \geq 1 \text{ k}\Omega$ | 99 | 100 | | %VDD |
| | BVDDPD | Broken VDD & Pull-down load $R_L \geq 1 \text{ k}\Omega$ | | 0 | 1 | %VDD |
| | BVDDPU | Broken VDD & Pull-up load to 5 V | No Broken Track diagnostic | | | %VDD |
| Clamped Output Level ⁽⁷⁾ | Clamp_lo | Programmable | 0 | | 100 | %VDD |
| Both Outputs OUT1 and OUT2 | Clamp_hi | Programmable | 0 | | 100 | %VDD |

As an illustration of the previous table, the MLX90333 fits the typical classification of the output span described on the Figure 2.

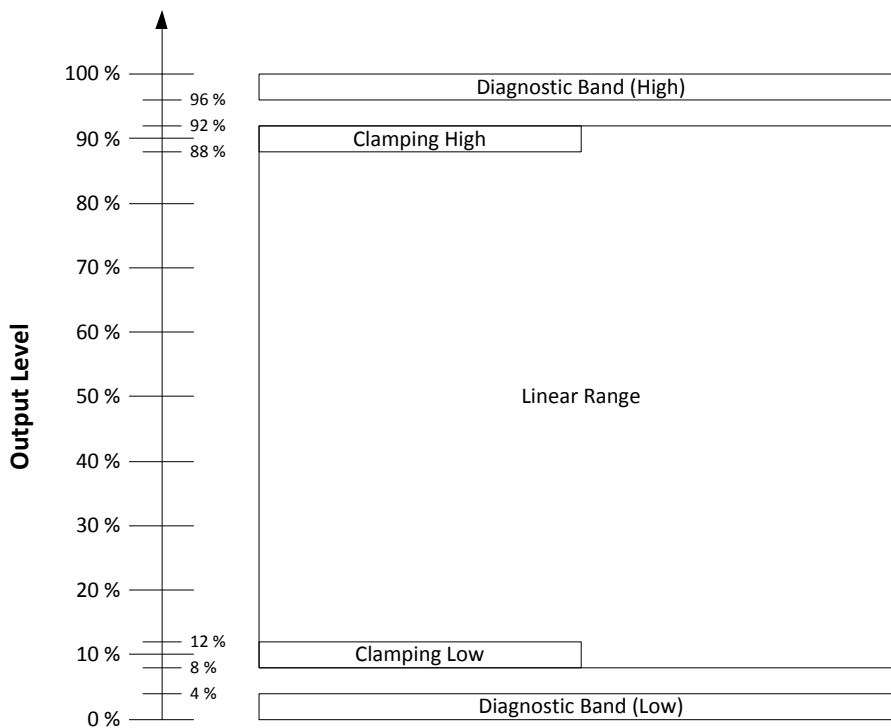

Figure 2 – Output Span Classification

⁶ For detailed information, see also section 14

⁷ Clamping levels need to be considered vs the saturation of the output stage (see V_{sat_lo} and V_{sat_hi})

7. Isolation Specification

DC Operating Parameters at $V_{DD} = 5V$ (unless otherwise specified) and for T_A as specified by the Temperature suffix (S, E, K or L). Only valid for the package code GO i.e. dual die version.

| Parameter | Symbol | Test Conditions | Min | Typ | Max | Units |
|----------------------|--------|-----------------|-----|-----|-----|-------|
| Isolation Resistance | | Between dice | 4 | | | MΩ |

8. Timing Specification

DC Operating Parameters at $V_{DD} = 5V$ (unless otherwise specified) and for T_A as specified by the Temperature suffix (S, E, K or L).

| Parameter | Symbol | Test Conditions | Min | Typ | Max | Units |
|----------------------------|------------------|------------------------------------------------------|-----|-----|------|-------|
| Main Clock Frequency | Ck | Slow mode ⁽⁸⁾ | | 7 | | MHz |
| | | Fast mode ⁽⁸⁾ | | 20 | | MHz |
| Sampling Rate | | Slow mode ⁽⁸⁾ | | 600 | 1000 | μs |
| | | Fast mode ⁽⁸⁾ | | 200 | 330 | μs |
| Step Response Time | Ts | Slow mode ⁽⁸⁾ , Filter = 5 ⁽⁹⁾ | | | 4 | ms |
| | | Fast mode ⁽⁸⁾ , Filter = 0 ⁽⁹⁾ | | 400 | 600 | μs |
| Watchdog | Wd | See section 14 | | | 5 | ms |
| Start-up Cycle | Tsu | Slow and Fast mode ⁽⁸⁾ | | | 15 | ms |
| Analog Output Slew Rate | | C _{OUT} = 42 nF | | 200 | | V/ms |
| | | C _{OUT} = 100 nF | | 100 | | V/ms |
| PWM Frequency | F _{PWM} | PWM Output Enabled | 100 | | 1000 | Hz |
| Digital Output Rise Time | | Mode 5 – 10 nF, R _L = 10 kΩ | | 120 | | μs |
| Both Outputs OUT1 and OUT2 | | Mode 7 – 10 nF, R _L = 10 kΩ | | 2.2 | | μs |
| Digital Output Fall Time | | Mode 5 – 10 nF, R _L = 10 kΩ | | 1.8 | | μs |
| Both Outputs OUT1 and OUT2 | | Mode 7 – 10 nF, R _L = 10 kΩ | | 1.9 | | μs |

⁸ See section 13.5.1 for details concerning Slow and Fast mode

⁹ See section 13.6 for details concerning Filter parameter

| Parameter | Symbol | Test Conditions | Min | Typ | Max | Units |
|-----------------------------------------------------------------------------|--------|-----------------------------------|-----|-----|-----|-------|
| Maximum Field amplitude Change ⁽¹⁰⁾ (%) vs. Field Frequency (Hz) | | AGC 90% ⁽¹¹⁾ | | | | |
| | | <u>Slow mode</u> ⁽⁸⁾ | | | | |
| | | Field Freq > 40Hz | -10 | | 10 | % |
| | | Field Freq = 20Hz | -30 | | 30 | % |
| | | <u>Fast mode</u> ⁽⁸⁾ | | | | |
| | | Field Freq > 150Hz | -12 | | 12 | % |
| | | Field Freq = 50Hz | -30 | | 30 | % |
| | | AGC 64% (MLX90333BCT only) | | | | |
| | | <u>Slow mode</u> ⁽⁸⁾ | | | | |
| | | Field Freq > 80Hz | -22 | | 22 | % |
| | | Field Freq = 50Hz | -30 | | 30 | % |
| | | <u>Fast mode</u> ⁽⁸⁾ | | | | |
| Field Freq > 250Hz | -30 | | 30 | % | | |
| Field Freq = 50Hz | -60 | | 60 | % | | |

9. Accuracy Specification

DC Operating Parameters at V_{DD} = 5V (unless otherwise specified) and for T_A as specified by the Temperature suffix (S, E, K or L).

| Parameter | Symbol | Test Conditions | Min | Typ | Max | Units |
|----------------------------------------------|---------------------|--------------------------------------------------------------|-----|-----|-----|-------------------|
| ADC Resolution on the raw signals X, Y and Z | R _{ADC} | Slow Mode ⁽¹²⁾ | | 15 | | bits |
| | | Fast Mode ⁽¹²⁾ | | 14 | | bits |
| Offset on the Raw Signals X, Y and Z | X0, Y0, Z0 | T _A = 25 Deg.C | -60 | | 60 | LSB ₁₅ |
| Mismatch on the Raw Signals X, Y and Z | SMISM _{XY} | T _A = 25 Deg.C Between X and Y | -1 | | 1 | % |
| | SMISM _{XZ} | T _A = 25 Deg.C Between X and Z ⁽¹³⁾ | -30 | | 30 | % |
| | SMISM _{YZ} | T _A = 25 Deg.C Between Y and Z ⁽¹³⁾ | -30 | | 30 | % |

¹⁰ Ex.: Magnetic field amplitude change in case of vibration

¹¹ Automatic Gain Control – see Section 13.5.2 for more information

¹² 15 bits corresponds to 14 bits + sign and 14 bits corresponds to 13 bits + sign. After angular calculation, this corresponds to 0.005Deg./LSB₁₅ in Low Speed Mode and 0.01Deg./LSB₁₄ in High Speed.

¹³ The mismatch between X and Z (Y and Z) can be reduced through the calibration of the 2 parameters k_Z and k_I as described in the formulas page 32 in order to take into account the IC mismatch and system tolerances (magnetic and mechanical).

| Parameter | Symbol | Test Conditions | Min | Typ | Max | Units |
|-------------------------------------------------------------------------------|----------------------|-----------------------------------------------------------------------|------|-------|-----|-------------------|
| Magnetic Angle Phase Error | ORTH _{XY} | T _A = 25 Deg.C | | | | |
| | | Between X and Y | -0.3 | | 0.3 | Deg. |
| | | Between X and Z | -10 | | 10 | Deg. |
| | ORTH _{XZ} | Between X and Z | -10 | | 10 | Deg. |
| | ORTH _{YZ} | Between Y and Z | -10 | | 10 | Deg. |
| Thermal Offset Drift #1 on the Raw Signals X, Y and Z ⁽¹⁴⁾ | | Thermal Offset Drift at the DSP input (excl. DAC and output stage) | | | | |
| | | Temperature suffix S, E and K | -60 | | 60 | LSB ₁₅ |
| | | Temperature suffix L | -90 | | 90 | LSB ₁₅ |
| Thermal Offset Drift #2 (to be considered only for the analog output mode) | | Thermal Offset Drift of the DAC and Output Stage | | | | |
| | | Temperature suffix S, E and K | -0.3 | | 0.3 | %VDD |
| | | Temperature suffix L | -0.4 | | 0.4 | %VDD |
| Thermal Drift of Sensitivity Mismatch ⁽¹⁵⁾ | ΔSMISM _{XY} | Temperature suffix S, E and K | -0.3 | | 0.3 | % |
| | | Temperature suffix L | -0.5 | | 0.5 | % |
| | ΔSMISM _{XZ} | Temperature suffix S, E and K | -1 | | 1 | % |
| | | Temperature suffix L | -1.5 | | 1.5 | % |
| Analog Output Resolution | R _{DAC} | 12 bits DAC (Theoretical – Noise free) | | 0.025 | | %VDD /LSB |
| | | INL | -4 | | 4 | LSB |
| | | DNL | -1 | | 1 | LSB |
| Output stage Noise | | Clamped Output | | 0.05 | | %VDD |
| Noise pk-pk ⁽¹⁶⁾ | | Gain = 14, Slow mode, Filter = 5 | | 5 | 10 | LSB ₁₅ |
| | | Gain = 14, Fast mode, Filter = 0 | | 10 | 20 | LSB ₁₅ |
| Ratiometry Error | | | -0.1 | 0 | 0.1 | %VDD |
| PWM Output Resolution | R _{PWM} | 12 bits (Theoretical – Jitter free) | | 0.025 | | %DC /LSB |

¹⁴ For instance, Thermal Offset Drift #1 equal $\pm 60\text{LSB}_{15}$ yields to max. ± 0.3 Deg. angular error for the computed angular information (output of the DSP). See Front End Application Note for more details. This is only valid if automatic gain is set (See section 13.5.2)

¹⁵ For instance, Thermal Drift of Sensitivity Mismatch equal $\pm 0.4\%$ yields to max. ± 0.1 Deg. angular error for the computed angular information (output of the DSP). See Front End Application Note for more details.

¹⁶ The application diagram used is described in the recommended wiring. For detailed information, refer to section Filter in application mode (Section 13.6).

| Parameter | Symbol | Test Conditions | Min | Typ | Max | Units |
|-----------------------------------|------------------|-------------------------------------------------|-----|-----|-----|-------------------|
| PWM Jitter ⁽¹⁷⁾ | J _{PWM} | Gain = 11, F _{PWM} = 250 Hz – 800Hz | | | 5 | LSB ₁₂ |
| Serial Protocol Output Resolution | R _{SP} | Theoretical – Jitter free | | 16 | | bits |

10. Magnetic Specification

DC Operating Parameters at V_{DD} = 5V (unless otherwise specified) and for T_A as specified by the Temperature suffix (S, E, K or L).

| Parameter | Symbol | Test Conditions | Min | Typ | Max | Units |
|-------------------------------------|-------------------------------------------------|----------------------------------------------|-------|-----|--------------------|---------------|
| Magnetic Flux Density | B _X , B _Y ⁽¹⁸⁾ | | 20 | 50 | 70 ⁽¹⁹⁾ | mT |
| Magnetic Flux Density | B _Z ⁽¹⁸⁾ | | 24 | | 140 | mT |
| IMC Gain in X and Y ⁽²⁰⁾ | GainIMC _{XY} | | 1.2 | 1.4 | 1.8 | |
| IMC Gain in Z ⁽²⁰⁾ | GainIMC _Z | | 1.1 | | 1.3 | |
| k factor | k | GainIMC _{XY} / GainIMC _Z | 1 | 1.2 | 1.5 | |
| Magnet Temperature Coefficient | TC _m | | -2400 | | 0 | ppm/ Deg.C |

11. CPU & Memory Specification

The DSP is based on a 16 bit RISC μ Controller. This CPU provides 5 MIPS while running at 20 MHz.

| Parameter | Symbol | Test Conditions | Min | Typ | Max | Units |
|-----------|--------|-----------------|-----|-----|-----|-------|
| ROM | | | | 10 | | KB |
| RAM | | | | 256 | | B |
| EEPROM | | | | 128 | | B |

¹⁷ Jitter is defined by $\pm 3 \sigma$ for 1000 successive acquisitions and the slope of the transfer curve is 100%DC/360 Deg.

¹⁸ The condition must be fulfilled for at least one field B_X, B_Y or B_Z

¹⁹ Above 70 mT, the IMC starts saturating yielding to an increase of the linearity error.

²⁰ This is the magnetic gain linked to the Integrated Magneto Concentrator structure. This is the overall variation. Within one lot, the part to part variation is typically $\pm 10\%$ versus the average value of the IMC gain of that lot.

12. End-User Programmable Items

| Parameter | Comments | Default Values | | | |
|----------------|---------------------------------------------------|----------------|---------|-------------|-------|
| | | BCH STD/IP1 | BCH SPI | BCT STD/IP1 | # bit |
| MAINMODE | Select Outputs Configuration | 0 | 0 | 0 | 2 |
| Outputs Mode | Output stages mode | 2 | N/A | 2 | 3 |
| PWMPOL1 | PWM Polarity (OUT1) | 0 | N/A | 0 | 1 |
| PWMPOL2 | PWM Polarity (OUT2) | 0 | N/A | 0 | 1 |
| PWM_Freq | PWM Frequency | 1000h | N/A | 1000h | 16 |
| 3-Points | 4 segments transfer curve for single angle output | 0 | 0 | 0 | 1 |
| ALPHA_POL | Revert the Sign of Alpha | 0 | 0 | 0 | 1 |
| ALPHA_MOD180 | Modulo Operation (180 Deg) on Alpha | 1 | 1 | 1 | 1 |
| ALPHA_DP | Alpha Discontinuity Point | 0 | 0 | 0 | 8 |
| ALPHA_DEADZONE | Alpha Dead Zone | 0 | 0 | 0 | 6 |
| ALPHA_S0 | Alpha Initial Slope | 4000h | 4000h | 4000h | 16 |
| ALPHA_X | Alpha X Coordinate | 4000h | 4000h | 4000h | 16 |
| ALPHA_Y | Alpha Y Coordinate | 8000h | 8000h | 8000h | 16 |
| ALPHA_S1 | Alpha S1 Slope | 4000h | 4000h | 4000h | 16 |
| BETA_POL | Revert the Sign of Beta | 0 | 0 | 0 | 1 |
| BETA_MOD180 | Modulo Operation (180 Deg) on Beta | 1 | 1 | 1 | 1 |
| BETA_DP | Beta Discontinuity Point | 0 | 0 | 0 | 6 |
| BETA_DEADZONE | Beta Dead Zone | 0 | 0 | 0 | 8 |
| BETA_S0 | Beta Initial Slope | 4000h | 4000h | 4000h | 16 |
| BETA_X | Beta X Coordinate | 4000h | 4000h | 4000h | 16 |
| BETA_Y | Beta Y Coordinate | 8000h | 8000h | 8000h | 16 |
| BETA_S1 | Beta S1 Slope | 4000h | 4000h | 4000h | 16 |
| CLAMP_LOW | Clamping Low | 0% | 0% | 0% | 16 |
| CLAMP_HIGH | Clamping High | 100% | 100% | 100% | 16 |

| Parameter | Comments | Default Values | | | |
|------------------------------------------|------------------------------------|---------------------|---------|-------------|-------|
| | | BCH STD/IP1 | BCH SPI | BCT STD/IP1 | # bit |
| 2D | | 0 | 0 | 0 | 1 |
| XYZ | SPI Only | 0 | 0 | 0 | 1 |
| KZ | | B3h | B3h | | 8 |
| KT ⁽²¹⁾ | | 80h | 80h | N/A | 8 |
| FIELDTHRES_LOW | | 0h | 0h | 0h | 8 |
| FIELDTHRES_HIGH | | 0h | 0h | 0h | 8 |
| DERIVGAIN | | 40h | 40h | 40h | 8 |
| FILTER | | 3 | 0 | 3 | 8 |
| FILTER A1 | Filter coefficient A1 for FILTER=6 | 6600h | 6600h | 6600h | 16 |
| FILTER A2 | Filter coefficient A2 for FILTER=6 | 2A00h | 2A00h | 2A00h | 16 |
| FILTERFIRST | | 0 | 0 | 0 | 1 |
| FHYST | | 0 | 0 | 0 | 8 |
| MLXID1 / MLXID2 / MLXID3 ⁽²²⁾ | | MLX | MLX | MLX | 16 |
| CUSTID1 | | 1 | 1 | 1 | 16 |
| CUSTID2 | | 17d ⁽²³⁾ | 37d | 38d | 16 |
| CUSTD3 | | MLX | MLX | MLX | 16 |
| HIGHSPEED | | 0 | 0 | 0 | 1 |
| GAINMIN | | 0 | 0 | 0 | 8 |
| GAINMAX | | 41d | 41d | 41d | 8 |
| EEHAMHOLE | | 3131h | 0h | 3131h | 16 |
| RESONFAULT | Diagnostic mode | 1h | N/A | 0h | 2 |
| MLXLOCK | | 0h | 0h | 0h | 1 |

²¹ Only applicable for MLX90333BCH

²² MLXIDs parameters contain unique ID programmed by Melexis to guarantee full part traceability

²³ CUSTID2 might also be 29d for MLX90333SDC-BCH-000

| Parameter | Comments | Default Values | | | |
|-----------|----------|----------------|---------|-------------|-------|
| | | BCH STD/IP1 | BCH SPI | BCT STD/IP1 | # bit |
| LOCK | | 0h | 1h | 0h | 1 |

Parameters for MLX90333xxx-BCT only

| | | | | | |
|---------------------------------|-------------------------------------------------------|-----|-----|-------|----|
| AGCRADIUSTARGET ⁽²⁴⁾ | Define Gain target 64% / 90% ADC | N/A | N/A | 0 | 1 |
| SWTHRES | Angle Trigger level for switch on OUT2 | N/A | N/A | FFFFh | 16 |
| SWLOW | Switch Low level output on OUT2 | N/A | N/A | 40h | 8 |
| SWHIGH | Switch High level output on OUT2 | N/A | N/A | FFh | 8 |
| SWHYST | Switch hysteresis | N/A | N/A | 0 | 8 |
| CodePWMLATCH | Enable synchronized % DC update | N/A | N/A | 1 | 1 |
| OUT1DIAG | Active Diagnostic Output 1 behavior | N/A | N/A | 0 | 1 |
| OUT2DIAG | Active Diagnostic Output 2 behavior | N/A | N/A | 0 | 1 |
| CodeKTALPHA | “Joystick” ALPHA angle correction parameter | N/A | N/A | 80h | 8 |
| CodeKTBETA | “Joystick” BETA angle correction parameter | N/A | N/A | 80h | 8 |
| CodeORTHZXALPHA | Front-end “Joystick” angle correction parameter | N/A | N/A | 0 | 8 |
| CodeORTHZYALPHA | Front-end “Joystick” angle correction parameter | N/A | N/A | 0 | 8 |
| CodeORTHZXBETA | Front-end “Joystick” angle correction parameter | N/A | N/A | 0 | 8 |
| CodeORTHZXBETA | Front-end “Joystick” angle correction parameter | N/A | N/A | 0 | 8 |
| CodeORTHZYBETA | Front-end “Joystick” angle correction parameter | N/A | N/A | 0 | 8 |
| CodeENHORTH | Enable enhanced Front-end “Joystick” angle correction | N/A | N/A | 0 | 1 |

²⁴ Option to use the same ADC target as MLX90333BCH. Default value equals lowered % ADC target

13. Description of End-User Programmable Items

13.1. Output Configuration

The parameter MAINMODE defines the output stages configuration

| MAINMODE | OUT1 | OUT2 |
|----------|-------|-----------------------------------------|
| 0 | ALPHA | BETA |
| 1 | BETA | ALPHA |
| 2 | ALPHA | ALPHA DERIVATE / SWITCH ⁽²⁵⁾ |
| 3 | BETA | BETA DERIVATE / SWITCH ⁽²⁵⁾ |

13.2. Output Mode

The MLX90333 output type is defined by the Output Mode parameter.

| Parameter | Value | Description |
|-----------------------------|-------|---------------------|
| Analog Output Mode | 2 | Analog Rail-to-Rail |
| PWM Output Mode | 5 | Low Side (NMOS) |
| | 7 | Push-Pull |
| Serial Protocol Output Mode | N/A | Low Side (NMOS) |

13.2.1. Analog Output Mode

The Analog Output Mode is a rail-to-rail and ratiometric output with a push-pull output stage configuration allows the use of a pull-up or pull-down resistor.

²⁵ Derivate = MLX90333BCH, Switch = MLX90333BCT

13.2.2. PWM Output Mode

If one of the PWM Output mode is selected, the output signal is a digital signal with Pulse Width Modulation (PWM).

In mode 5, the output stage is an open drain NMOS transistor (low side), to be used with a pull-up resistor to VDD.

In mode 7, the output stage is a push-pull stage for which Melexis recommends the use of a pull-up resistor to VDD.

The PWM polarity of the OUT1 (OUT2) is selected by the PWMPOL1 (PWMPOL2) parameter:

- PWMPOL1 (PWMPOL2) = 0 for a low level at 100%
- PWMPOL1 (PWMPOL2) = 1 for a high level at 100%

The PWM frequency is selected by the PWM_Freq parameter.

| Oscillator Mode | Pulse-Width Modulation Frequency (Hz) | | | |
|-----------------|---------------------------------------|--------|--------|--------|
| | 100 | 200 | 500 | 1000 |
| Low Speed | ~35000 | ~17500 | ~7000 | ~3500 |
| High Speed | - | ~50000 | ~20000 | ~10000 |

Table 3 – PWM Frequency Code (based on typical main clock frequency)

For instance, in Low Speed Mode, set PWM_Freq=7000 (decimal) to set the PWM frequency around 500Hz ⁽²⁶⁾.

13.2.3. Serial Protocol Output Mode

The MLX90333 features a digital Serial Protocol mode. The MLX90333 is configured as a Slave node. The frame layer type is defined by the parameter XYZ as described in the next table.

| Parameter | Value | Description |
|-----------|-------|-------------------------------|
| XYZ | 0 | Regular SPI Frame Alpha, Beta |
| | 1 | X, Y, Z Frame |

See the dedicated Serial Protocol section for a full description (Section 15).

²⁶ In order to compensate the lot to lot variation of the main clock frequency (Ck), Melexis strongly recommends trimming the PWM frequency during EOL programming (see the PTC-04 documentation).

13.2.4. Switch Out

| Parameter | Value | Unit |
|-----------|------------|------|
| SWTHRES | 0 ... 100 | % |
| SWHYST | 0 ... 0.39 | % |
| SWLOW | 0 ... 100 | % |
| SWHIGH | 0 ... 100 | % |

The output level on OUT2 is changed from SWLOW to SWHIGH when the output value is greater than the value stored in the SWTHRES parameter.

The SWHYST defines the hysteresis amplitude around the Switch point. The switch is actually activated if the digital output value is greater than SWTHRES+SWHYST. It is deactivated if the digital output value is less than SWTHRES-SWHYST.

If the Switch feature is not used in the application, the output pin needs to be connected to the ground and disabled in EEPROM.

13.3. Output Transfer Characteristic

| Parameter | Value | Description |
|-----------|-------|---------------------------------------------------|
| 3-Points | 0 | Regular Alpha, Beta Output (2 times 2 segments) |
| | 1 | Alpha (or Beta) Single Output (1 time 4 segments) |

The 3-Points parameters allow the user to use the 3-points mapping (4 segments). This mode can only be used for Mainmode equals 2 and 3.

- 3-Points = 0, the parameters list is described as bellow (Angle Alpha and Beta):

| Parameter | Value | Unit |
|-----------------------------|----------------|------|
| ALPHA_POL BETA_POL | 0, 1 | |
| ALPHA_MOD180 BETA_MOD180 | 0, 1 | |
| ALPHA_DP BETA_DP | 0 ... 359.9999 | Deg |
| ALPHA_X BETA_X | 0 ... 359.9999 | Deg |
| ALPHA_Y BETA_Y | 0 ... 100 | % |

| Parameter | Value | Unit |
|----------------|----------------|---------|
| ALPHA_S0 | 0 ... 17 | % / Deg |
| ALPHA_S1 | | |
| BETA_S0 | | |
| BETA_S1 | | |
| CLAMP_LOW | 0 ... 100 | % |
| CLAMP_HIGH | 0 ... 100 | % |
| ALPHA_DEADZONE | 0 ... 359.9999 | Deg |
| BETA_DEADZONE | | |

- 3-Points = 1, the parameters list is described as bellow (Angle Alpha or Beta):

| Parameter | Value | Unit |
|------------|-------------------|---------|
| ALPHA_POL | 0 → CCW 1 → CW | |
| DP | 0 ... 359.9999 | Deg |
| LNR_A_X | 0 ... 359.9999 | Deg |
| LNR_B_X | | |
| LNR_C_X | | |
| LNR_A_Y | 0 ... 100 | % |
| LNR_B_Y | | |
| LNR_C_Y | | |
| LNR_S0 | 0 ... 17 | % / Deg |
| LNR_A_S | | |
| LNR_B_S | | |
| LNR_C_S | -17 ... 0 ... 17 | % / Deg |
| CLAMP_LOW | 0 ... 100 | % |
| CLAMP_HIGH | 0 ... 100 | % |
| DEADZONE | 0 ... 359.9999 | Deg |

13.3.1. The Polarity and Modulo Parameters

The angle Alpha is defined as the arctangent of Z/X and Beta as the arctangent of Z/Y. It is possible to invert the polarity of these angles via the parameters ALPHA_POL and BETA_POL set to "1".

The MLX90333 can also be insensitive to the field polarity by setting the ALPHA_MOD180/BETA_MOD180 to "1".

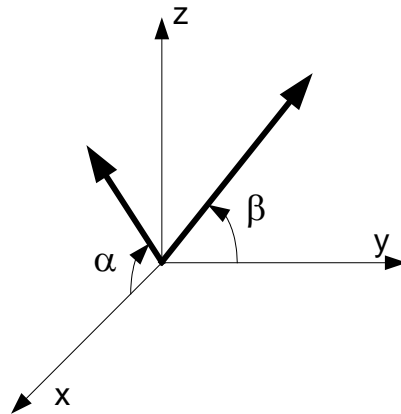

13.3.2. Alpha/Beta Discontinuity Point (or Zero Degree Point)

The Discontinuity Point (DP) defines the zero point of the circle (Alpha or Beta). The discontinuity point places the origin at any location of the trigonometric circle (see Figure 5).

For a Joystick Application, Melexis recommends to set the DP to zero.

13.3.3. LNR Parameters

The LNR parameters, together with the clamping values, fully define the relation (the transfer function) between the digital angles (Alpha and Beta) and the output signals.

The shape of the MLX90333 transfer function from the digital angle values to the output voltages is described by the drawing below (see Figure 3). Four segments can be programmed but the clamping levels are necessarily flat (3-Points = 0).

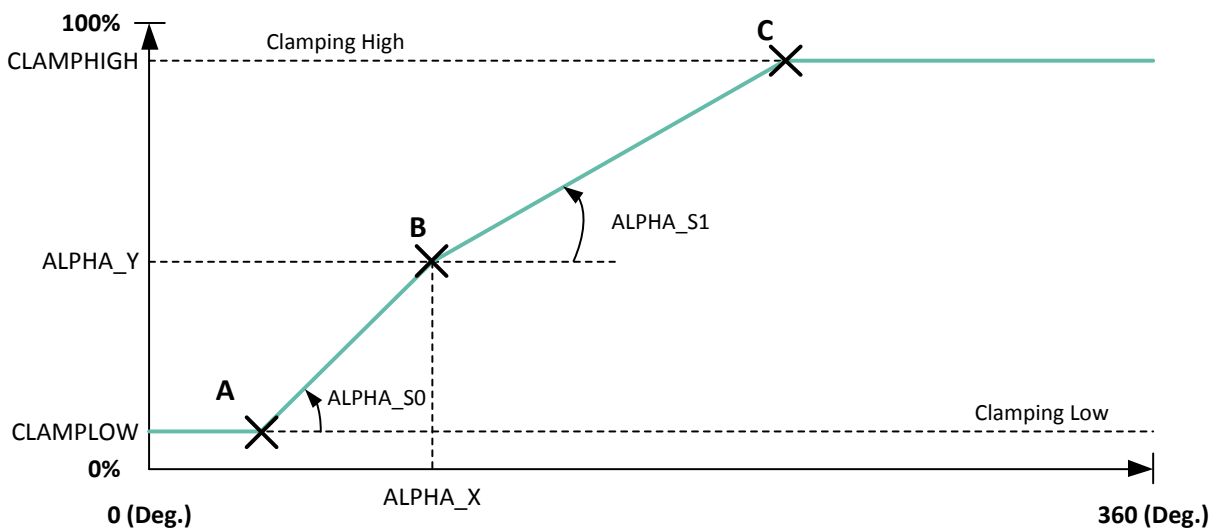

Figure 3 – Digital Angle (Alpha) Transfer Characteristic (Idem ditto for Beta)

In the case of one single angle output (3-Points = 1), the shape of the MLX90333 transfer function from the digital angle values to the output voltage is described by the drawing below (See Figure 4). Six segments can be programmed but the clamping levels are necessarily flat.

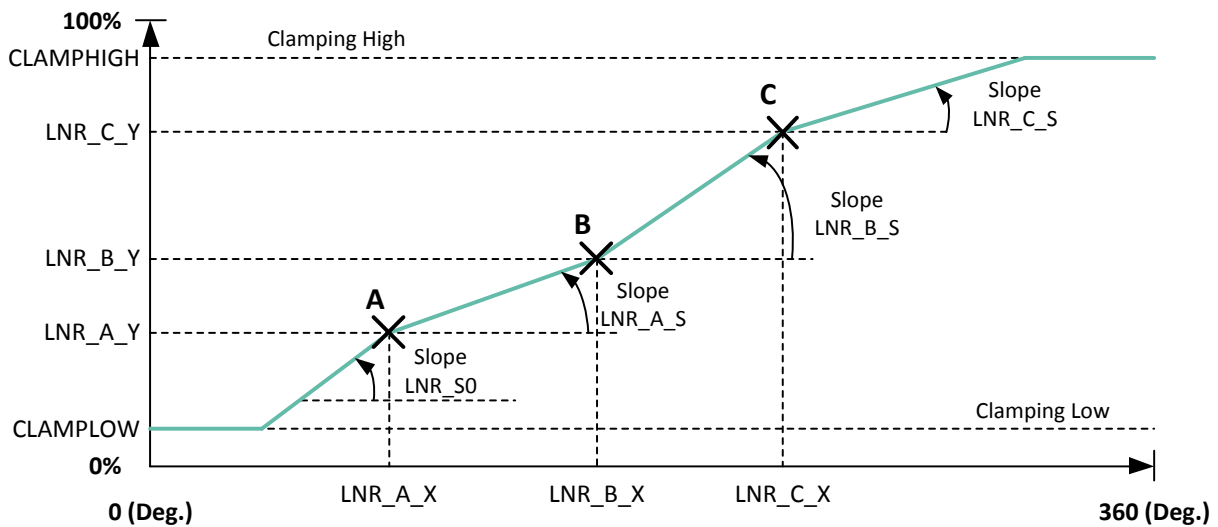

Figure 4 – Digital Angle (Alpha) Transfer Characteristic for Single Angle Output

13.3.4. CLAMPING Parameters

The clamping levels are two independent values to limit the output voltage range in normal operation. The CLAMP_LOW parameter sets the minimum output voltage level while the CLAMP_HIGH parameter sets the maximum output voltage level. Both parameters have 16 bits of adjustment. In analog mode the resolution will be limited by the D/A converter (12 bits) to 0.024%V_{DD}. In PWM mode the resolution will be 0.024%DC. In SPI mode the resolution is 14 bits or 0.022 Deg. over 360 Deg.

13.3.5. DEADZONE Parameter

The dead zone is defined as the angle window between 0 and 359.9999 Deg. (See Figure 5).

When the digital angle (Alpha or Beta) lies in this zone, the IC is in fault mode (RESONFAULT must be set to “1” – See 13.8.2).

In case of ALPHA_MOD180 (or BETA_MOD180) is not set, the angle between 180 Deg. and 360 Deg. will generate a “deadzone” fault, unless DEADZONE = 0.

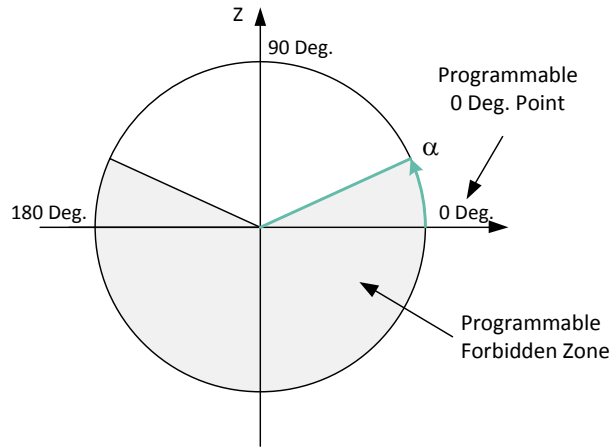

Figure 5 – Discontinuity Point and Dead Zone (Alpha - Idem ditto for Beta)

13.4. Identification

| Parameter | Value | Unit |
|-----------|-------------|------|
| MLXID1 | 0 ... 65535 | |
| MLXID2 | 0 ... 65535 | |
| MLXID3 | 0 ... 65535 | |
| CUSTID1 | 0 ... 65535 | |
| CUSTID2 | 0 ... 65535 | |
| CUSTID3 | 0 ... 65535 | |

Identification number: 48 bits freely useable by Customer for traceability purpose.

13.5. Sensor Front-End

| Parameter | Value | Unit |
|-----------------|--------------------------------|------|
| HIGHSPEED | Slow mode = 0 Fast mode = 1 | |
| GAINMIN | 0 ... 41 | |
| GAINMAX | 0 ... 41 | |
| FIELDTHRES_LOW | 0 ... 100 | % |
| FIELDTHRES_HIGH | 0 ... 100 | % |

13.5.1. HIGHSPEED Parameter

The HIGHSPEED parameter defines the main frequency for the DSP:

- HIGHSPEED = 0 selects the Slow mode with a 7 MHz master clock.
- HIGHSPEED = 1 selects the Fast mode with a 20 MHz master clock.

For better noise performance, the Slow Mode must be enabled.

13.5.2. GAINMIN and GAINMAX Parameters

The MLX90333 features an automatic gain control (AGC) of the analog chain. The AGC loop is based on

$$\text{Max}(|V_x|, |V_y|, |V_z|) = |\text{Amplitude}| = \text{Radius}$$

and it targets an amplitude of 90% of the ADC input span.

In MLX90333BCT, this default target is changed to 64% but can be set to 90% by enabling the parameter AGCRADIUSTARGET.

The current gain can be read out with the programming unit PTC-04 and gives a rough indication of the applied magnetic flux density (Amplitude).

GAINMIN & GAINMAX define the boundaries within the gain setting is allowed to vary. Outside this range, the outputs are set in diagnostic low.

13.5.3. FIELDTHRES_LOW and FIELDTHRES_HIGH Parameters

The strength of the applied field is constantly calculated in a background process. The value of this field can be read out with the PTC-04 and gives a rough indication of the applied magnetic flux density (Amplitude).

FIELDTHRES_LOW & FIELDTHRES_HIGH define the boundaries within the actual field strength (Radius) is allowed to vary. Outside this range, the outputs are set in diagnostic low.

13.6. FILTER

| Parameter | Value | Unit |
|-------------|---------------------|------|
| FHYST | 0 ... 11; step 0.04 | Deg. |
| FILTER | 0 ... 6 | |
| FILTERFIRST | 0, 1 | |

The MLX90333 includes 3 types of filters:

- Hysteresis Filter: programmable by the FHYST parameter
- Low Pass FIR Filters controlled with the Filter parameter
- Low Pass IIR Filter controlled with the Filter parameter and the coefficients FILTER A1 and FILTER A2

Note: if the parameter FILTERFIRST is set to “1”, the filtering is active on the digital angle. If set to “0”, the filtering is active on the output transfer function.

13.6.1. Hysteresis Filter

The FHYST parameter is a hysteresis filter. The output value of the IC is not updated when the digital step is smaller than the programmed FHYST parameter value. The output value is modified when the increment is bigger than the hysteresis. The hysteresis filter reduces therefore the resolution to a level compatible with the internal noise of the IC. The hysteresis must be programmed to a value close to the noise level.

13.6.2. FIR Filters

The MLX90333 features 6 FIR filter modes controlled with Filter = 0 ... 5. The transfer function is described below:

$$y_n = \frac{1}{\sum_{i=0}^j a_i} \sum_{i=0}^j a_i x_{n-i}$$

The characteristics of the filters no 0 to 5 is given in the Table 4.

| Filter No (j) | 0 | 1 | 2 | 3 | 4 | 5 |
|---------------------------|-----------|-------------------------|--------|--------|--------|--------|
| Type | Disable | Finite Impulse Response | | | | |
| Coefficients $a_0... a_5$ | N/A | 110000 | 121000 | 133100 | 111100 | 122210 |
| Title | No Filter | Extra Light | | Light | | |
| 90% Response Time | 1 | 2 | 3 | 4 | 4 | 5 |
| 99% Response Time | 1 | 2 | 3 | 4 | 4 | 5 |

| Filter No (j) | 0 | 1 | 2 | 3 | 4 | 5 |
|---------------------|---|-----|-----|-----|-----|-----|
| Efficiency RMS (dB) | 0 | 2.9 | 4 | 4.7 | 5.6 | 6.2 |
| Efficiency P2P (dB) | 0 | 2.9 | 3.6 | 5.0 | 6.1 | 7.0 |

Table 4 – FIR Filters Selection Table

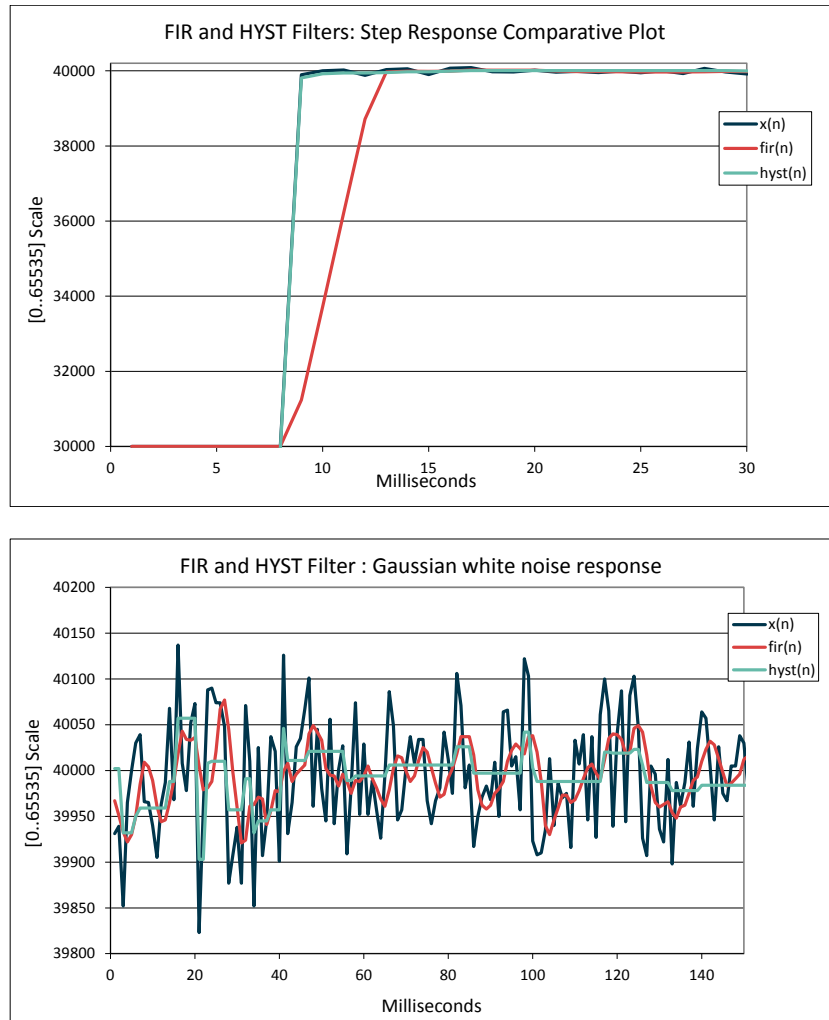

Figure 6 – Step Response and Noise Response for FIR (No 3) and FHYST = 10

13.6.3. IIR Filters

The IIR Filter is enabled with Filter = 6. The diagram of the IIR Filter implemented in the MLX90333 is given in Figure 7. Only the parameters A1 and A2 are configurable (See Table 5).

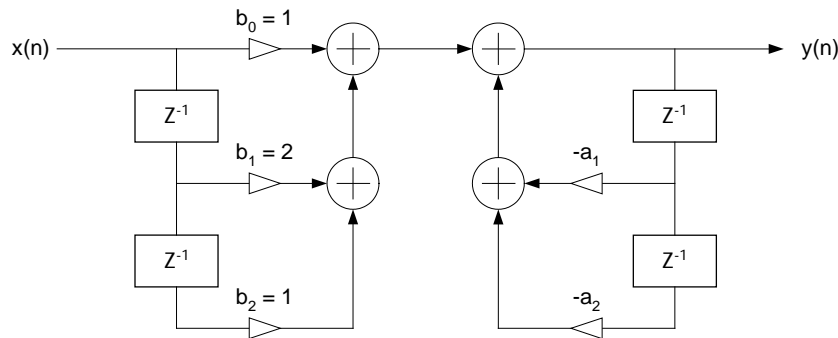

Figure 7 - IIR Diagram

| Filter No | 6 | | | | | |
|---------------------|-------------------------------------------------------|-------|-------|-------|-------|-------|
| Type | 2 nd Order Infinite Impulse Response (IIR) | | | | | |
| Title | Medium & Strong | | | | | |
| 90% Response Time | 11 | 16 | 26 | 40 | 52 | 100 |
| Efficiency RMS (dB) | 9.9 | 11.4 | 13.6 | 15.3 | 16.2 | > 20 |
| Efficiency P2P (dB) | 12.9 | 14.6 | 17.1 | 18.8 | 20.0 | > 20 |
| Coefficient A1 | 26112 | 28160 | 29120 | 30208 | 31296 | 31784 |
| Coefficient A2 | 10752 | 12288 | 12992 | 13952 | 14976 | 15412 |

Table 5 – IIR Filter Selection Table

The Figure 8 shows the response of the filter to a Gaussian noise with default coefficient A1 and A2.

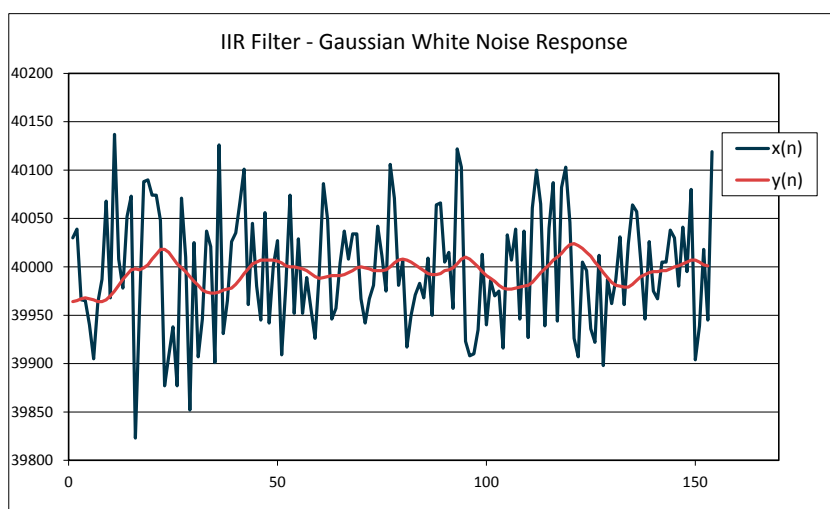

Figure 8 – Noise Response for the IIR Filter

13.7. Programmable Enhanced “Joystick” Angle Correction ²⁷

| Parameter | Value | Unit |
|-------------------------------------------------------|---------------------------|------|
| KTALPHA KTBETA | [0 ... 200] / 128 | LSB |
| ORTHZXALPHA ORTHZYALPHA ORTHZXBETA ORTHZBETA | [-128 ... 127] / 256 | LSB |
| ENHORTH | Disable = 0 Enable = 1 | |

13.7.1. Enhanced “Joystick” Angle Formula

$$\alpha = ATAN \left(\frac{\sqrt{(k_z V_z)^2 + (k_t (V_y - ORTH_{zy} * V_z))^2}}{V_x - ORTH_{zx} * V_z} \right)$$

$$\beta = ATAN \left(\frac{\sqrt{(k_z V_z)^2 + (k_t (V_x - ORTH_{zx} * V_z))^2}}{V_y - ORTH_{zy} * V_z} \right)$$

The enhanced “joystick” angle function is enabled by parameter ENORTH. Parameters are automatically calculated when using the MLX90333BCT/ 9 points solver to optimize the shape of Betaout vs Alphaout in accordance to the mechanical boundaries of the Joystick.

13.8. Programmable Diagnostic Settings

| Parameter | Value | Unit |
|----------------------|-------------------------------|------|
| OUT1DIAG OUT2DIAG | DIAGLOW = 0 DIAGHIGH = 1 | |
| RESONFAULT | Disable = 0 Enable = 1 | |
| EEHAMHOLE | Enable = 0 Disable = 3131h | |

²⁷ Only Applicable for MLX90333BCT

13.8.1. OUTxDIAG Parameter

This OUT1DIAG, OUT2DIAG parameters define the behavior of the output in case of a diagnostic situation.

13.8.2. RESONFAULT Parameter

The RESONFAULT parameter enables the soft reset when a fault is detected by the CPU when the parameter is set to “1”. It is recommended to set it to “1” to activate the self diagnostic modes (See section 14).

Note that in the User Interface (MLX90333UI), the RESONFAULT is a cluster of the following two bits, i.e. the 2 bits are both disabled or both enabled:

- DRESONFAULT: disable the reset in case of a fault.
- DOUTINFAULT: disable output in diagnostic low in case of fault.

It is recommended to set both EEPROM parameters to “0” to activate the self diagnostic modes.

13.8.3. EEHAMHOLE Parameter

The EEHAMHOLE parameter disables the CRC check and the memory recovery (Hamming code) when it is equal to 3131h. Melexis strongly recommends setting the parameter to “0” (enable memory recovery). The parameter is set automatically to “0” by the solver function “MemLock”.

13.9. Lock

| Parameter | Value | Unit |
|-----------|-------|------|
| MLXLOCK | 0, 1 | |
| LOCK | 0, 1 | |

13.9.1. MLXLOCK Parameter

MLXLOCK locks all the parameters set by Melexis.

13.9.2. LOCK Parameter

LOCK locks all the parameters set by the user. Once the lock is enabled, it is not possible to change the EEPROM values. However it is still possible to read back the memory contents with the PTC-04 programmer.

Note that the lock bit should be set by the solver function “MemLock”.

14. Self Diagnostic

The MLX90333 provides numerous self-diagnostic features. Those features increase the robustness of the IC functionality as it will prevent the IC to provide erroneous output signal in case of internal or external failure modes (“fail-safe”).

| Fault Mode | Action | Effect on Outputs | Remark |
|----------------------------------------------------------------------------|---------------------------------------------------------------------------------------------|--------------------------------|------------------------------------------------------------|
| ROM CRC Error at start up (64 words including Intelligent Watch Dog - IWD) | CPU Reset ⁽²⁸⁾ | Diagnostic low ⁽²⁹⁾ | All the outputs are already in Diagnostic low - (start-up) |
| ROM CRC Error (Operation - Background task) | Enter Endless Loop: - Progress (watchdog Acknowledge) - Set Outputs in Diagnostic low | Immediate Diagnostic low | |
| RAM Test Fail (Start up) | CPU Reset | Diagnostic low | All the outputs are already in Diagnostic low (start-up) |
| Calibration Data CRC Error (Start-Up) | Hamming Code Recovery | | Start-Up Time is increased by 3 ms if successful recovery |
| Hamming Code Recovery Error (Start-Up) | CPU Reset | Immediate Diagnostic low | See section 13.8.3 |
| Calibration Data CRC Error (Operation - Background) | CPU Reset | Immediate Diagnostic low | |
| Dead Zone Alpha Dead Zone Beta | Set Outputs in Diagnostic low. Normal Operation until the “dead zone” is left. | Immediate Diagnostic low | Immediate recovery if the “dead zone” is left |
| ADC Clipping (ADC Output is 0000h or 7FFFh) | Set Outputs in Diagnostic low. Normal mode and CPU Reset If recovery | Immediate Diagnostic low | |

²⁸ CPU reset means

1. Core Reset (same as Power-On-Reset). It induces a typical start up time.
2. Periphery Reset (same as Power-On-Reset)
3. Fault Flag/Status Lost
4. The reset can be disabled by clearing the RESONFAULT bit (See 13.8.1)

²⁹ Refer to section 6 for the Diagnostic Output Level specifications

| Fault Mode | Action | Effect on Outputs | Remark |
|----------------------------------------------------------------------|----------------------------------------------------------------------------------------|-----------------------------------------------------------------------------------------------------|-------------------------------------------------------------------------|
| Radius Overflow (> 100%) or Radius Underflow (< 50 %) | Set Outputs in Diagnostic low. Normal mode and CPU Reset If recovery | Immediate Diagnostic low | (50 % - 100 %) No magnet / field too high See also section 13.5.2 |
| Field Clipping (Radius < FIELDTHRES_LOW or Radius > FIELDTHRES_HIGH) | Set Outputs in Diagnostic low. Normal mode, and CPU Reset If recovery | Immediate Diagnostic low | See also section 13.5.3 |
| Rough Offset Clipping (RO is < 0d or > 127d) | Set Outputs in Diagnostic low. Normal mode, and CPU Reset If recovery | Immediate Diagnostic low | |
| Gain Clipping (GAIN < GAINMIN or GAIN > GAINMAX) | Set Outputs in Diagnostic low. Normal mode, and CPU Reset If recovery | Immediate Diagnostic low | See also section 13.5.2 |
| DAC Monitor (Digital to Analog converter) | Set Outputs in Diagnostic low. Normal Mode with immediate recovery without CPU Reset | Immediate Diagnostic low | |
| ADC Monitor (Analog to Digital Converter) | Set Outputs in Diagnostic low. Normal Mode with immediate recovery without CPU Reset | Immediate Diagnostic low | ADC Inputs are Shorted |
| Undervoltage Mode | At Start-Up, wait Until VDD > 3V. During operation, CPU Reset after 3 ms debouncing | - VDD < POR level => Outputs high impedance - POR level < VDD < 3 V => Outputs in Diagnostic low | |
| Firmware Flow Error | CPU Reset | Immediate Diagnostic low | Intelligent Watchdog (Observer) |
| Read/Write Access out of physical memory | CPU Reset | Immediate Diagnostic low | 100% Hardware detection |
| Write Access to protected area (IO and RAM Words) | CPU Reset | Immediate Diagnostic low | 100% Hardware detection |
| Unauthorized entry in "SYSTEM" Mode | CPU Reset | Immediate Diagnostic low | 100% Hardware detection |
| VDD > 7 V | Set Output High Impedance (Analog) | Pull down resistive load => Diag. Low Pull up resistive load => Diag. High ⁽²⁹⁾ | 100% Hardware detection |

| Fault Mode | Action | Effect on Outputs | Remark |
|-------------|---------------------------------------------------------------|-------------------------------------------------------------------------------------|---------------------------------------------------------------------------------------------------------------------------------------------------------------------------------------------------------------------------|
| VDD > 9.4 V | IC is switched off (internal supply) CPU Reset on recovery | Pull down resistive load => Diag. Low Pull up resistive load => Diag. High | 100% Hardware detection |
| Broken Vss | CPU Reset on recovery | Pull down resistive load => Diag. Low Pull up resistive load => Diag. High | 100% Hardware detection. Pull down load $\leq 10\text{ k}\Omega$ to meet Diag Low spec: - < 2% VDD (temperature suffix S and E) - < 4% VDD (temperature suffix K) - contact Melexis for temperature suffix L |
| Broken VDD | CPU Reset on recovery | Pull down resistive load => Diag. Low Pull up resistive load => Diag. High | No valid diagnostic for VPULLUP = VDD. Pull up load ($\leq 10\text{ k}\Omega$) to VPULLUP > 8 V to meet Diag Hi spec > 96% VDD. |

15. Serial Protocol

15.1. Introduction

The MLX90333 features a digital Serial Protocol mode. The MLX90333 is configured as a Slave node. The serial protocol of the MLX90333 is a three wires protocol (/SS, SCLK, MOSI-MISO):

- /SS pin is a 5 V tolerant digital input
- SCLK pin is a 5 V tolerant digital input
- MOSI-MISO pin is a 5 V tolerant open drain digital input/output

The basic knowledge of the standard SPI specification is required for the good understanding of the present section.

15.2. SERIAL PROTOCOL Mode

- CPHA = 1 → even clock changes are used to sample the data
- CPOL = 0 → active-Hi clock

The positive going edge shifts a bit to the Slave's output stage and the negative going edge samples the bit at the Master's input stage.

15.3. MOSI (Master Out Slave In)

The Master sends a command to the Slave to get the angle information.

15.4. MISO (Master In Slave Out)

The MISO of the slave is an open-collector stage. Due to the capacitive load, a >1 kΩ pull-up is used for the recessive high level (in fast mode). Note that MOSI and MISO use the same physical pin of the MLX90333.

15.5. /SS (Slave Select)

The /SS pin enables a frame transfer (if CPHA = 1). It allows a re-synchronization between Slave and Master in case of communication error.

15.6. Master Start-Up

/SS, SCLK, MISO can be undefined during the Master start-up as long as the Slave is re-synchronized before the first frame transfer.

15.7. Slave Start-Up

The slave start-up (after power-up or an internal failure) takes 16 ms. Within this time /SS and SCLK is ignored by the Slave. The first frame can therefore be sent after 16 ms. MISO is Hi-Z (i.e. Hi-Impedance) until the Slave is selected by its /SS input. MLX90333 will cope with any signal from the Master while starting up.

15.8. Timing

To synchronize communication, the Master deactivates /SS high for at least t5 (1.5 ms). In this case, the Slave will be ready to receive a new frame. The Master can re-synchronize at any time, even in the middle of a byte transfer.

Note: Any time shorter than t5 leads to an undefined frame state, because the Slave may or may not have seen /SS inactive.

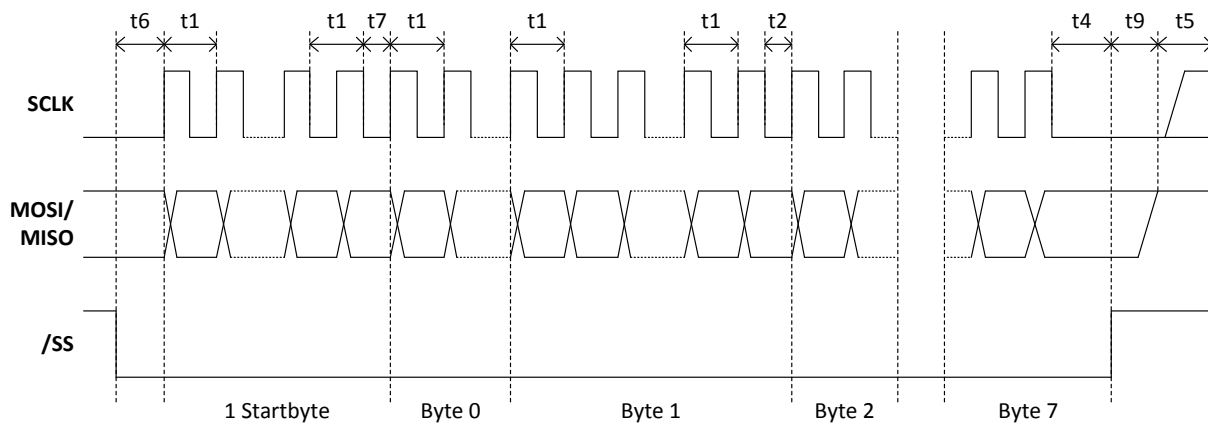

| Timings | Min ⁽³⁰⁾ | Max | Remarks |
|---------|-----------------------------|-----|------------------------------------------------------------------------------------------------|
| t1 | 2.3 μ s / 6.9 μ s | - | No capacitive load on MISO. t1 is the minimum clock period for any bits within a byte. |
| t2 | 12.5 μ s / 37.5 μ s | - | t2 the minimum time between any other byte |
| t4 | 2.3 μ s / 6.9 μ s | - | Time between last clock and /SS = high = chip de-selection |
| t5 | 300 μ s / 1500 μ s | - | Minimum /SS = Hi time where it's guaranteed that a frame re-synchronizations will be started. |
| t5 | 0 μ s | - | Maximum /SS = Hi time where it's guaranteed that NO frame re-synchronizations will be started. |

³⁰ Timings shown for oscillator base frequency of 20MHz (Fast Mode) / 7 MHz (Slow Mode)

A data frame consists of 8 bytes:

| Data Frame | XYZ = 0 | XYZ = 1 |
|-----------------------------|-------------------------------------------|---------|
| 1 start byte | FFh | |
| 2 data bytes (LSByte first) | Alpha | X |
| 2 data bytes (LSByte first) | Beta | Y |
| 2 data bytes (LSByte first) | Error Code | Z |
| 1 SUM byte | 8 LSB of the sum of the transmitted bytes | |

15.10.3. Timing

There are no timing limits for frames: a frame transmission could be initiated at any time. There is no inter-frame time defined.

15.10.4. Data Structure

The DATA could be a valid angle/field component or an error condition.

DATA: Angle/Field Component A[15:0] with (Span)/2¹⁶

| Least Significant Byte | | | | | | | | Most Significant Byte | | | | | | | |
|------------------------|----|----|----|----|----|----|-----|-----------------------|-----|-----|-----|-----|-----|----|-----|
| MSB | | | | | | | LSB | MSB | | | | | | | LSB |
| A7 | A6 | A5 | A4 | A3 | A2 | A1 | A0 | A15 | A14 | A13 | A12 | A11 | A10 | A9 | A8 |

DATA: Error

| Least Significant Byte | | | | | | | | Most Significant Byte | | | | | | | |
|------------------------|----|----|----|----|----|----|-----|-----------------------|-----|-----|-----|-----|-----|----|-----|
| MSB | | | | | | | LSB | MSB | | | | | | | LSB |
| E7 | E6 | E5 | E4 | E3 | E2 | E1 | E0 | E15 | E14 | E13 | E12 | E11 | E10 | E9 | E8 |

| BIT | NAME | Description |
|-----|--------------|---------------------------------------------------------|
| E0 | - | |
| E1 | - | |
| E2 | F_ADCMONITOR | ADC Failure |
| E3 | F_ADCSATURA | ADC Saturation (Electrical failure or field too strong) |
| E4 | F_GAINTOOLOW | The gain code is strictly less than EE_GAINMIN |

| BIT | NAME | Description |
|-----|-----------------|-----------------------------------------------------------------------|
| E5 | F_GAINTOOHIGH | The gain code is strictly greater than EE_GAINMAX |
| E6 | F_NORMTOOLOW | Goes high when the fast norm (the max of absolute X,Y,Z) is below 30% |
| E7 | F_FIELDTOOLOW | The norm (Square root) is strictly less than EE_FIELDLOW |
| E8 | F_FIELDTOOHIGH | The norm (Square root) is strictly greater than EE_FIELDHIGH |
| E9 | F_ROCLAMP | Analog Chain Rough Offset Compensation: Clipping |
| E10 | - | |
| E11 | F_DEADZONEALPHA | The angle ALPHA lies in the deadzone |
| E12 | - | |
| E13 | - | |
| E14 | - | |
| E15 | F_DEADZONEBETA | The angle BETA lies in the deadzone |

15.10.5. Angle Calculation

All communication timing is independent (asynchronous) of the angle data processing. The angle is calculated continuously by the Slave:

- Slow Mode: every 1.5 ms at most.
- Fast Mode: every 350 μ s at most.

The last angle calculated is hold to be read by the Master at any time. Only valid angles are transferred by the Slave, because any internal failure of the Slave will lead to a soft reset.

15.10.6. Error Handling

In case of any errors listed in section 15.10.4, the Serial protocol will be initialized and the error condition can be read by the master.

In case of any other errors (ROM CRC error, EEPROM CRC error, RAM check error, intelligent watchdog error...) the Slave's serial protocol is not initialized. The MOSI/MISO pin will stay Hi-impedant (no error frames are sent).

16. Recommended Application Diagrams

16.1. Analog Output Wiring in SOIC-8 Package

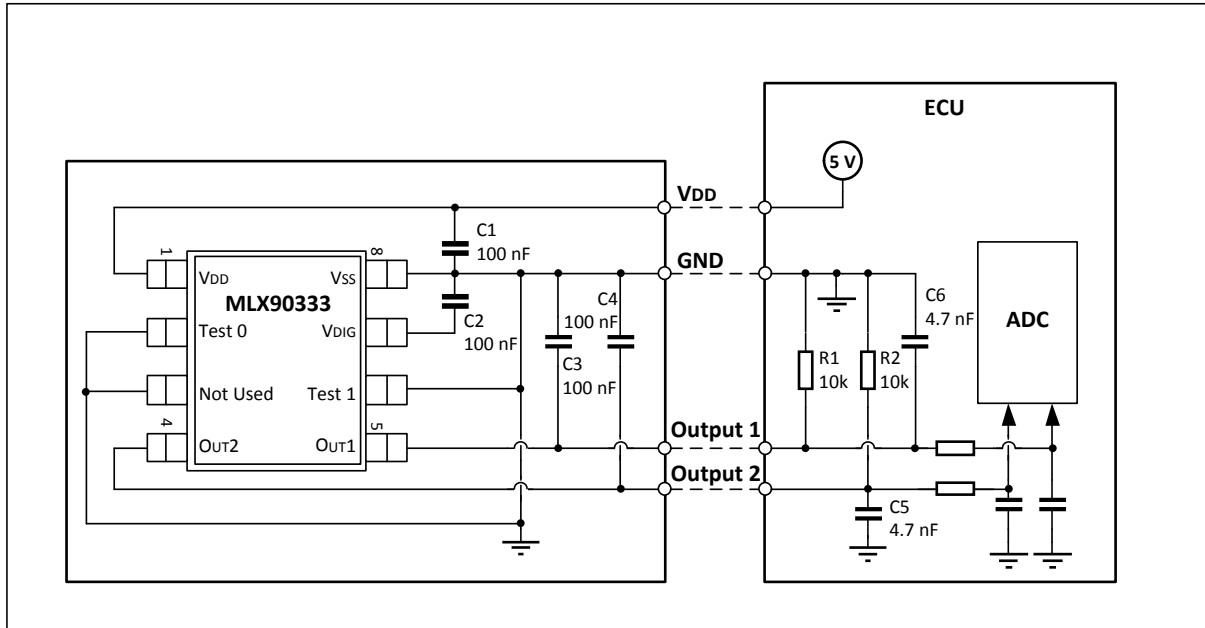

Figure 10 – Recommended wiring in SOIC-8 package

16.2. PWM Low Side Output Wiring

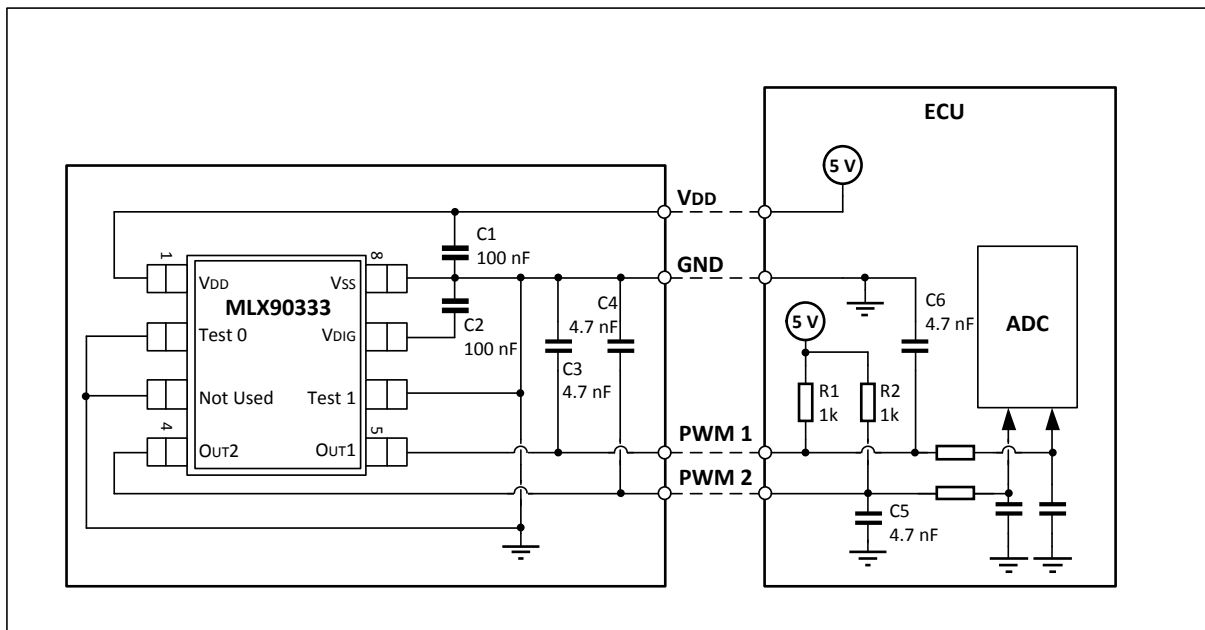

Figure 11 – Recommended wiring for a PWM Low Side Output configuration

16.3. Analog Output Wiring in TSSOP-16 Package

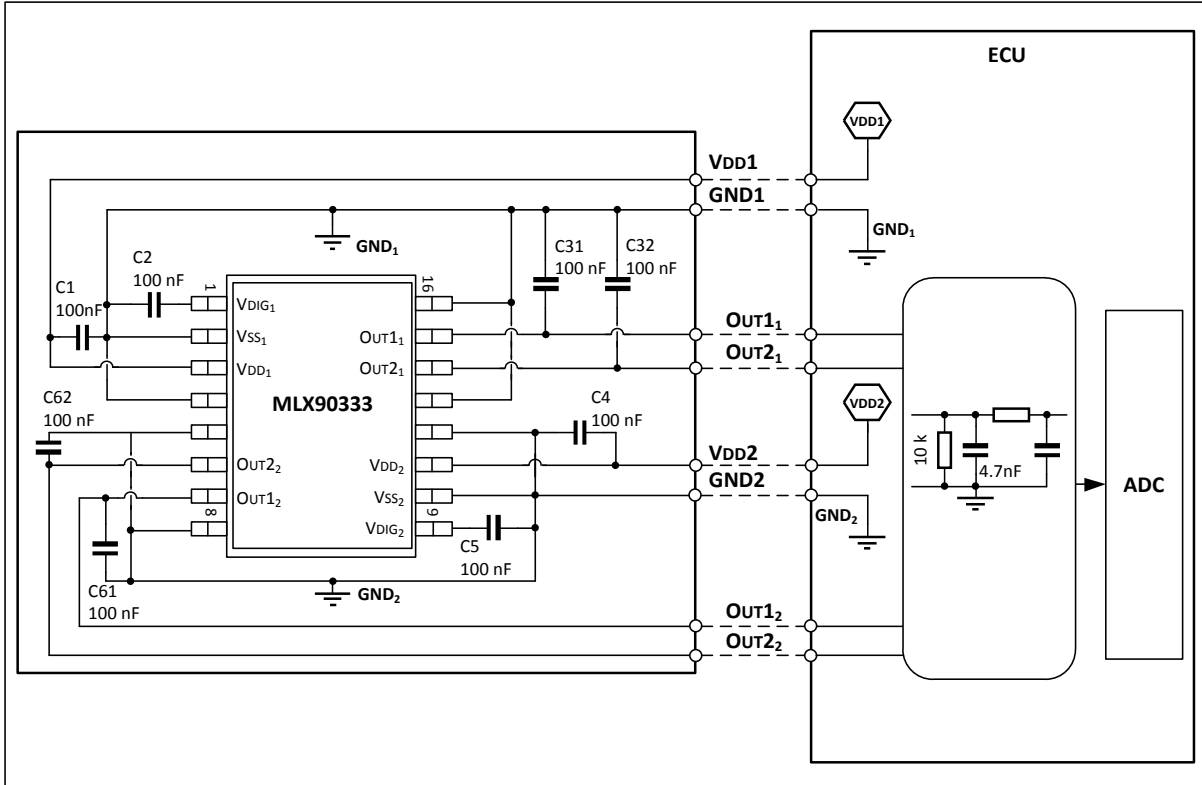

Figure 12 – Recommended wiring in TSSOP-16 package (dual die)

17. Standard information regarding manufacturability of Melexis products with different soldering processes

Our products are classified and qualified regarding soldering technology, solderability and moisture sensitivity level according to standards in place in Semiconductor industry.

For further details about test method references and for compliance verification of selected soldering method for product integration, Melexis recommends reviewing on our web site the General Guidelines soldering recommendation (<http://www.melexis.com/en/quality-environment/soldering>).

For all soldering technologies deviating from the one mentioned in above document (regarding peak temperature, temperature gradient, temperature profile etc), additional classification and qualification tests have to be agreed upon with Melexis.

For package technology embedding trim and form post-delivery capability, Melexis recommends consulting the dedicated trim&forming recommendation application note: lead trimming and forming recommendations (<http://www.melexis.com/en/documents/documentation/application-notes/lead-trimming-and-forming-recommendations>).

Melexis is contributing to global environmental conservation by promoting lead free solutions. For more information on qualifications of RoHS compliant products (RoHS = European directive on the Restriction Of the use of certain Hazardous Substances) please visit the quality page on our website: <http://www.melexis.com/en/quality-environment>.

18. ESD Precautions

Electronic semiconductor products are sensitive to Electro Static Discharge (ESD).

Always observe Electro Static Discharge control procedures whenever handling semiconductor products.

19. Package Information

19.1. SOIC-8 - Package Dimensions

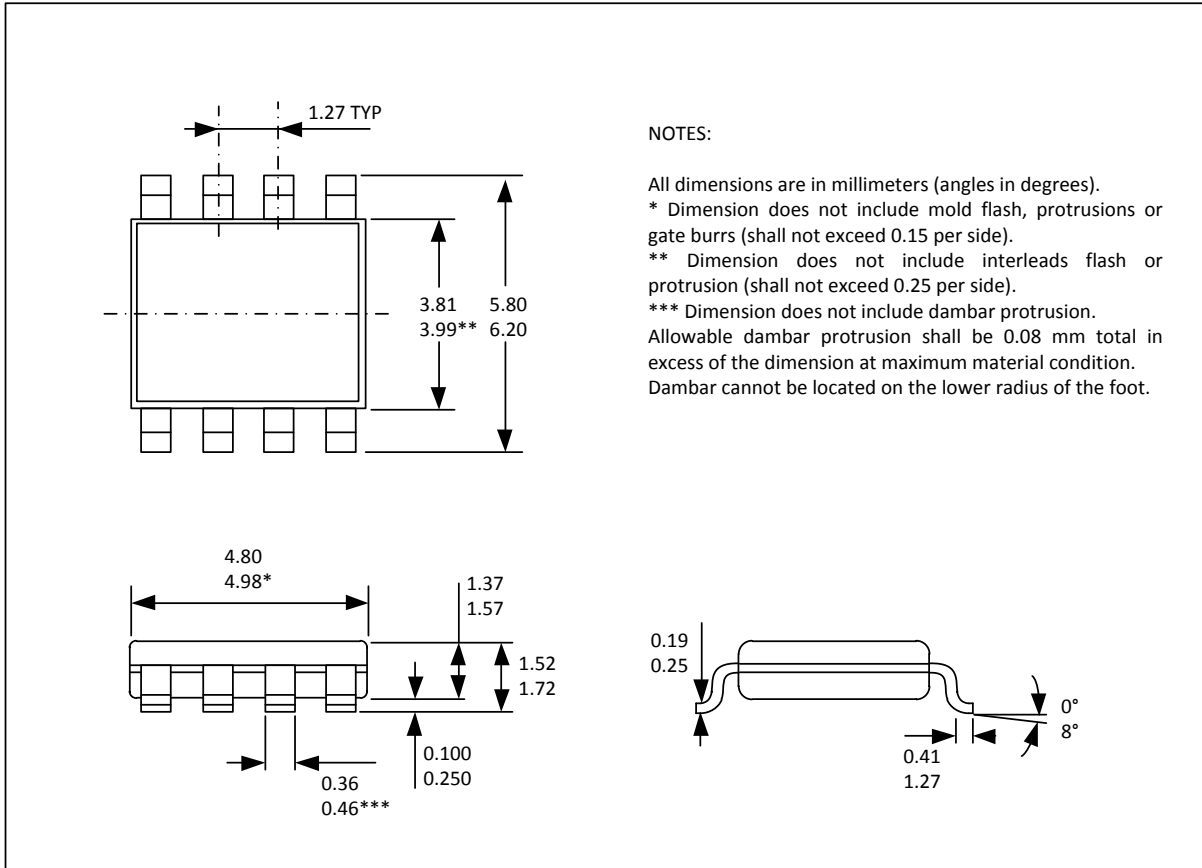

19.2. SOIC-8 - Pinout and Marking

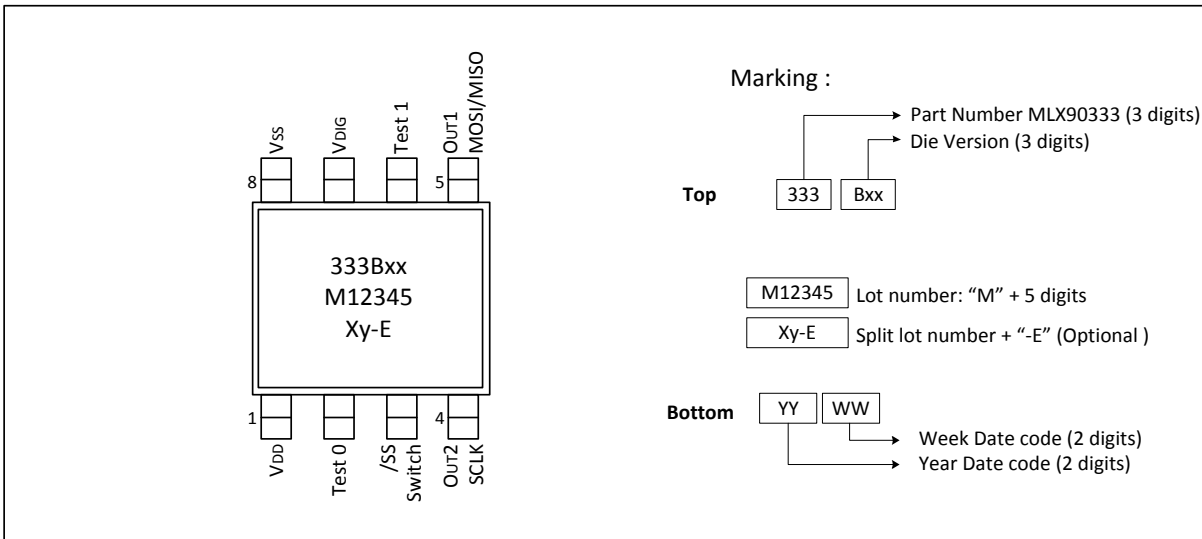

19.3. SOIC-8 - IMC Positioning

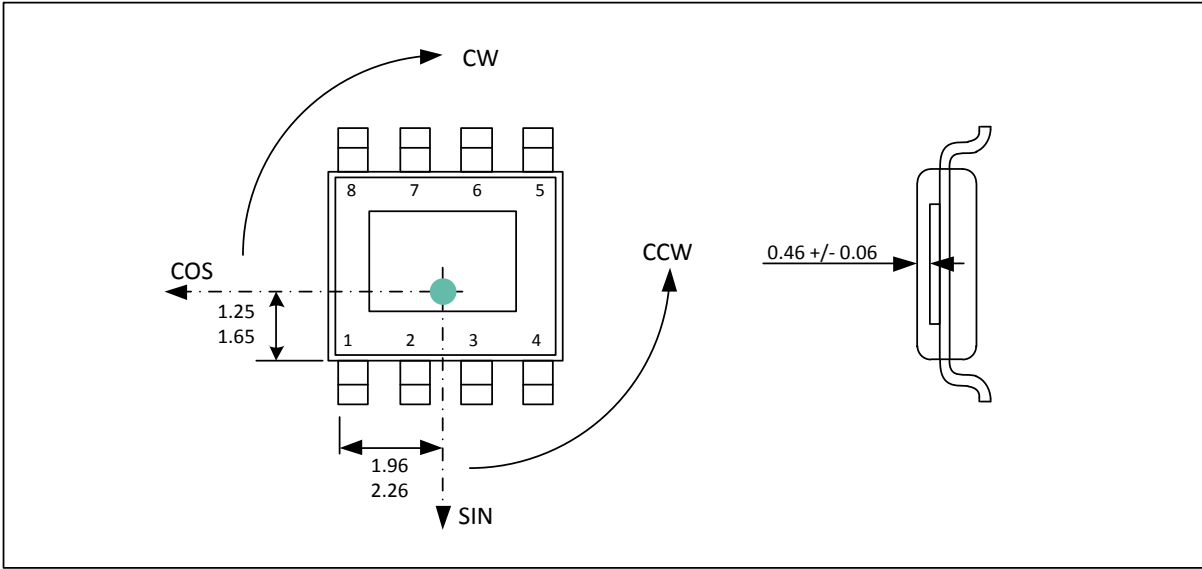

19.4. TSSOP-16 - Package Dimensions

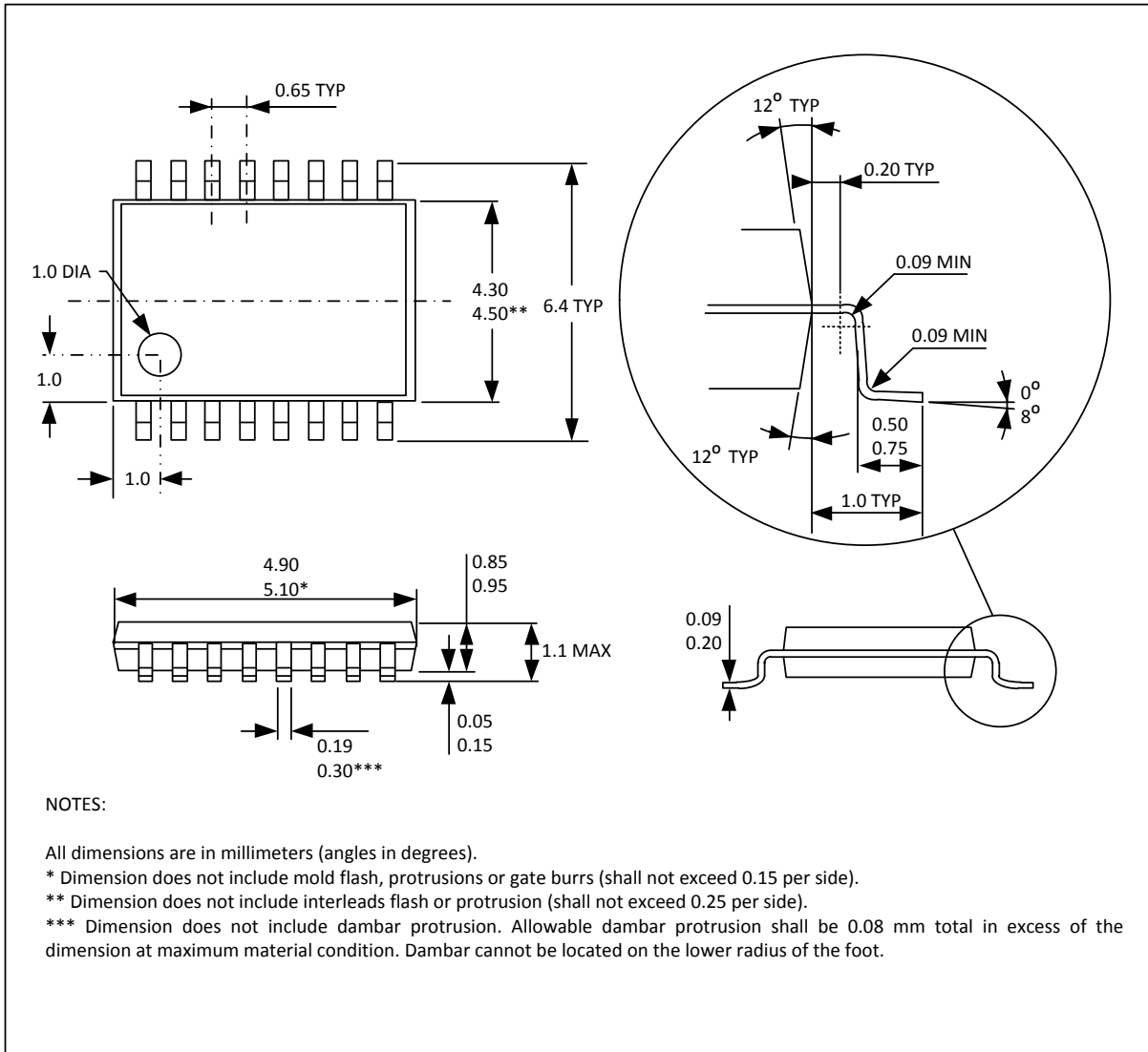

19.5. TSSOP-16 - Pinout and Marking

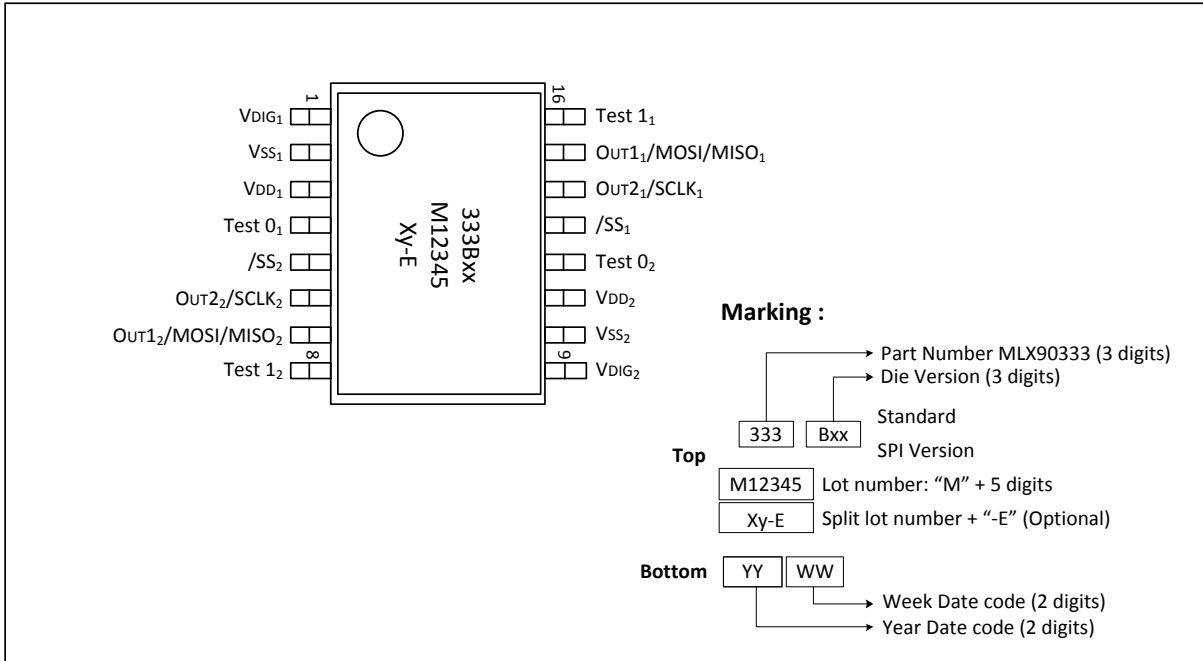

19.6. TSSOP-16 - IMC Positioning

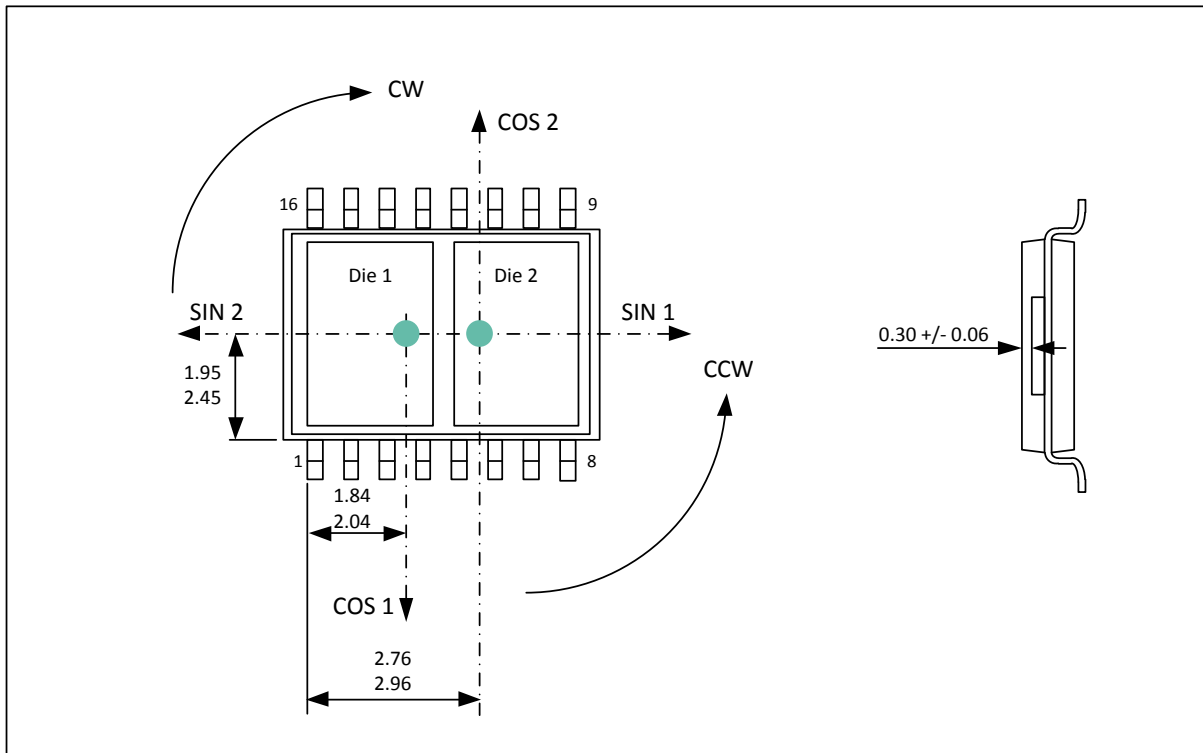

20. Disclaimer

The information furnished by Melexis herein is believed to be correct and accurate. Melexis disclaims (i) any and all liability in connection with or arising out of the furnishing, performance or use of the technical data or use of the product as described herein, (ii) any and all liability, including without limitation, special, consequential or incidental damages, and (iii) any and all warranties, express, statutory, implied, or by description, including warranties of fitness for particular purpose, non-infringement and merchantability. No obligation or liability shall arise or flow out of Melexis' rendering of technical or other services.

The information contained herein is provided "as is" and Melexis reserves the right to change specifications and/or any other information contained herein at any time and without notice. Therefore, before placing orders and/or prior to designing this product into a system, users or any third party should obtain the latest version of the relevant information to verify that the information being relied upon is current. This document supersedes and replaces all prior information regarding the product(s) as described herein and/or previous versions of this document.

Users or any third party must further determine the suitability of the Melexis' product(s) described herein for its application, including the level of reliability required and determine whether it is fit for a particular purpose.

The information contained herein is proprietary and/or confidential information of Melexis. The information contained herein or any use thereof does not grant, explicitly or implicitly, to any party any patent rights, licenses, or any other intellectual property rights, whether with regard to such information itself or anything described by such information.

This document as well as the product(s) described herein may be subject to export control regulations. Please be aware that export might require a prior authorization from competent authorities.

The product(s) as described herein is/are intended for use in normal commercial applications. Unless otherwise agreed upon in writing, the product(s) described herein are not designed, authorized or warranted to be suitable in applications requiring extended temperature range, unusual environmental requirements. High reliability applications, such as medical life-support or life-sustaining equipment are specifically not recommended by Melexis.

The product(s) may not be used for the following applications subject to export control regulations: the development, production, processing, operation, maintenance, storage, recognition or proliferation of 1) chemical, biological or nuclear weapons, or for the development, production, maintenance or storage of missiles for such weapons; 2) civil firearms, including spare parts or ammunition for such arms; 3) defense related products, or other material for military use or for law enforcement; 4) any applications that, alone or in combination with other goods, substances or organisms could cause serious harm to persons or goods and that can be used as a means of violence in an armed conflict or any similar violent situation.

Products sold by Melexis are subject to the terms and conditions as specified in the Terms of Sale, which can be found at <https://www.melexis.com/en/legal/terms-and-conditions>.

Melexis NV © - No part of this document may be reproduced without the prior written consent of Melexis. (2017)

ISO/TS 16949 and ISO14001 Certified

21. Contact

For the latest version of this document, go to our website at www.melexis.com. For additional information, please contact our Direct Sales team and get help for your specific needs:

| | |
|----------------|--------------------------------------------------------------------------------------------------------------|
| Europe, Africa | Telephone: +32 13 67 04 95 Email : sales_europe@melexis.com |
| Americas | Telephone: +1 603 223 2362 Email : sales_usa@melexis.com |
| Asia | Email : sales_asia@melexis.com |

Компания «Life Electronics» занимается поставками электронных компонентов импортного и отечественного производства от производителей и со складов крупных дистрибьюторов Европы, Америки и Азии.

С конца 2013 года компания активно расширяет линейку поставок компонентов по направлению коаксиальный кабель, кварцевые генераторы и конденсаторы (керамические, пленочные, электролитические), за счёт заключения дистрибьюторских договоров

Мы предлагаем:

- Конкурентоспособные цены и скидки постоянным клиентам.
- Специальные условия для постоянных клиентов.
- Подбор аналогов.
- Поставку компонентов в любых объемах, удовлетворяющих вашим потребностям.
- Приемлемые сроки поставки, возможна ускоренная поставка.
- Доставку товара в любую точку России и стран СНГ.
- Комплексную поставку.
- Работу по проектам и поставку образцов.
- Формирование склада под заказчика.
- Сертификаты соответствия на поставляемую продукцию (по желанию клиента).
- Тестирование поставляемой продукции.
- Поставку компонентов, требующих военную и космическую приемку.
- Входной контроль качества.
- Наличие сертификата ISO.

В составе нашей компании организован Конструкторский отдел, призванный помогать разработчикам, и инженерам.

Конструкторский отдел помогает осуществить:

- Регистрацию проекта у производителя компонентов.
- Техническую поддержку проекта.
- Защиту от снятия компонента с производства.
- Оценку стоимости проекта по компонентам.
- Изготовление тестовой платы монтаж и пусконаладочные работы.



Тел: +7 (812) 336 43 04 (многоканальный)

Email: org@lifeelectronics.ru