

ZMSM Series with Mounting Hole Subminiature Snap-acting Switches (IP65)

Features/Benefits

- Reliable snap-acting mechanism
- Long electrical and mechanical life
- Various PCB terminals and actuators
- RoHS compatible
- IP67 with potted wires only

Typical Applications

- Communication devices
- Testing equipment
- Security/Alarm systems

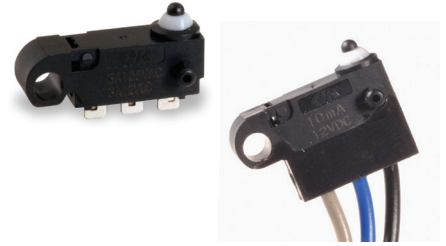

UL61058-1 

Specifications

CONTACT RATING: 3A@ 125 V AC/ 3A@ 12 V DC, 0.01 A@ 12 V DC.
ELECTRICAL LIFE: 100,000 cycles @ 0.01 A, 12 V DC / 100,000 cycles @ 3A, 12 V DC, 6,000 cycles @ 3A, 125 VAC
INSULATION RESISTANCE: 100 M ohm min.
DIELECTRIC STRENGTH: 500 Vrms.
OPERATING TEMPERATURE: -40°C + 85°C.
OPERATING FORCE: 130 grams.

* Low Level=conditions where no arcing occurs during switching, i.e., 0.4 VA max.
@ 20 V AC or DC max.

Materials

CASE: Nylon
COVER/ACTUATOR: PBT
MOVABLE CONTACTS: 3 Amp silver, 0.01A gold
STATIONARY CONTACTS: 3 Amp silver, 0.01A gold
TERMINALS: Brass, Pre-plated with silver
LEVER: Stainless steel

NOTE: Specifications and materials listed above are for switches with standard option. For information on specific and custom switches, consult Customer Service Center.

 Sealing cap could possibly be damaged in case of contacts with oils or greases. Please try to avoid direct contact. If more support is needed, consult Customer Service Centre.

Build-A-Switch

To order, simply select desired option from each category and place in the appropriate box. Available options are shown and described on pages J-62 through J-64. For additional options not shown in catalog, consult Customer Service Center.

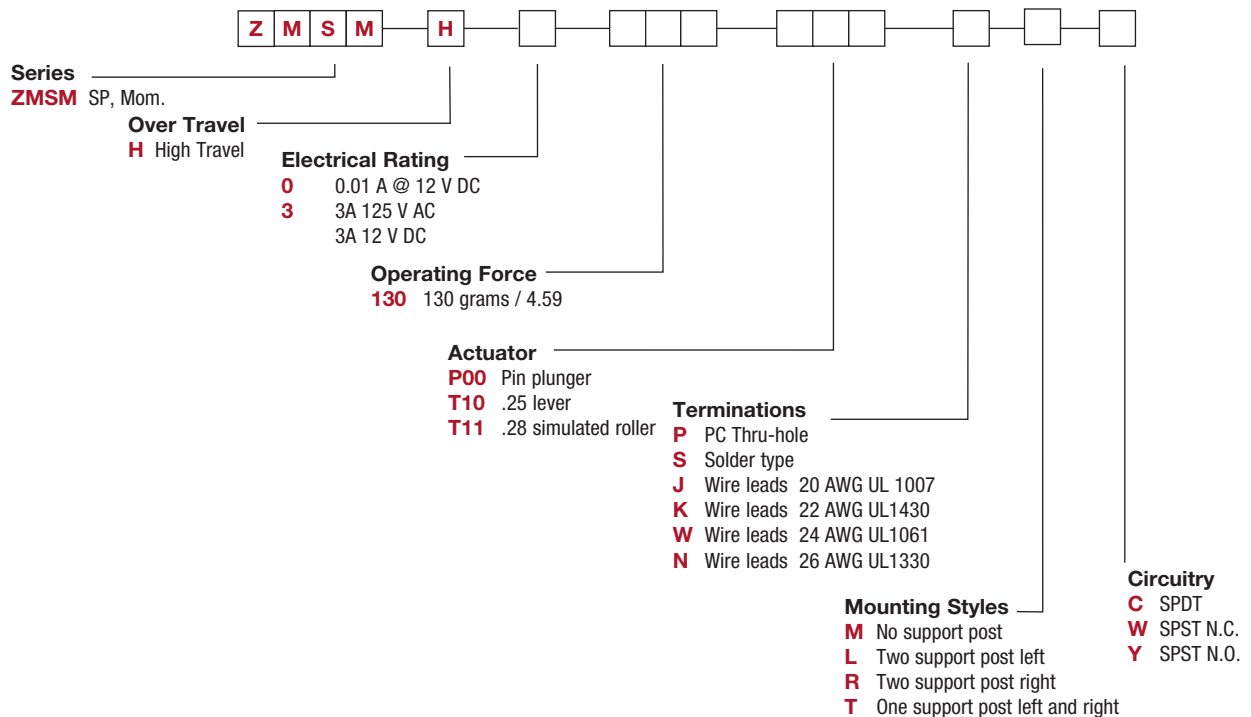

ZMSM Series with Mounting Hole Subminiature Snap-acting Switches (IP65)

SERIES

ZMSMH HIGH OVER TRAVEL

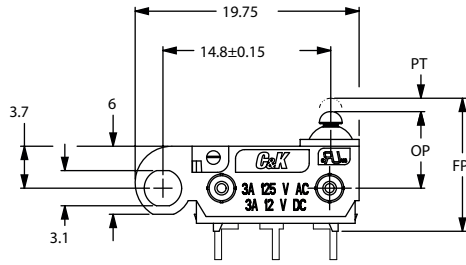
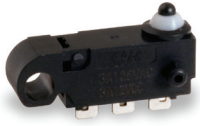

MODEL SHOWN: ZMSMHXXXP00PLC

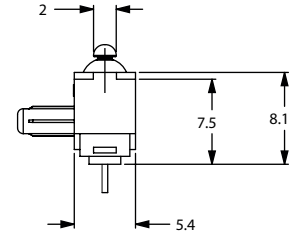

Snap-acting

ELECTRICAL RATING

OPTION CODE	RoHS COMPLIANT*	RoHS COMPATIBLE*	CONTACT MATERIAL		ELECTRICAL RATING
			MOVABLE CONTACT	STATIONARY CONTACT	
0	Yes	Yes	Gold alloy		0.01 A @ 12 V DC
3	Yes	Yes	Silver alloy		3 AMPS @ 125 V AC 3 AMPS @ 12 V DC

Model **C&K** US with option "S" (solder type) only.
Consult Customer Service center for availability and delivery of nonstandard ratings.

OPERATING FORCE

OPTION CODE	BASIC SWITCH OPERATING FORCE (OZ./GRAMS)
130	130 4.59

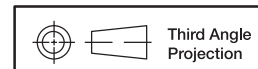

Third Angle Projection

Dimensions are shown: mm
Specifications and dimensions subject to change



ZMSM Series with Mounting Hole Subminiature Snap-acting Switches (IP65)

ACTUATOR

P00 PIN PLUNGER (IP65)

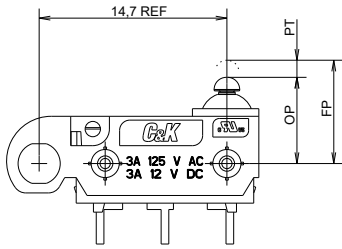

MODEL SHOWN: ZMSMHXXXXP00PLC

T10 .25 LEVER (IP65)

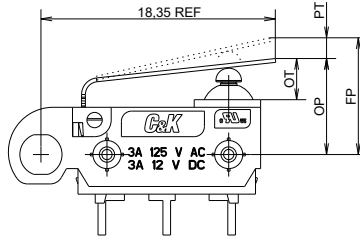

MODEL SHOWN: ZMSMHXXXXT10PLC

T11 LEVER (IP65)

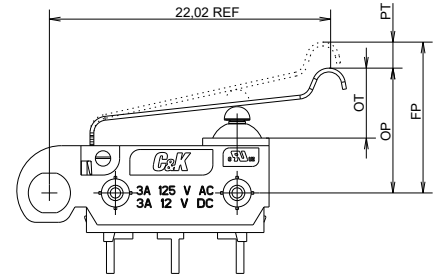

MODEL SHOWN: ZMSMHXXXXT11PLC

SWITCH CHARACTERISTICS

Actuator code	Maximum Operate Force (grams/oz.)	Minimum Release Force (grams/oz.)	Free Position Max (mm)	Maximum Pre-travel (mm)	Operate Position (mm)	Maximum Differential (mm)	Overtravel min. (mm)
P00	130 4.59	13 0.45	7.35	0.8	6.75 ± 0.3	0.3	1.75
T10	195 6.88	55 1.93	10.70	3.85	7.40 ± 0.8	0.5	2.3
T11	160 5.64	45 1.58	13.80	4.8	9.90 ± 0.8	0.7	2.6

TERMINATIONS

P PC THRU-HOLE (IP65)

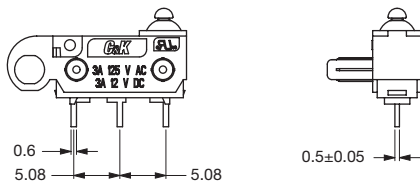

MODEL SHOWN: ZMSMHXXXXP00PLC

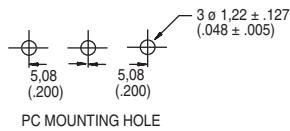

S SOLDER TYPE (IP65)

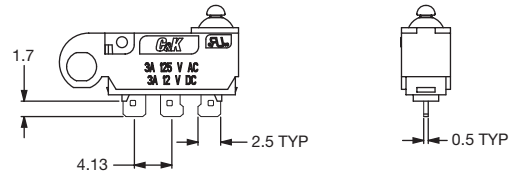

MODEL SHOWN: ZMSMHXXXXP00SMC

J, K, W, N WIRE LEADS BOTTOM (IP67)

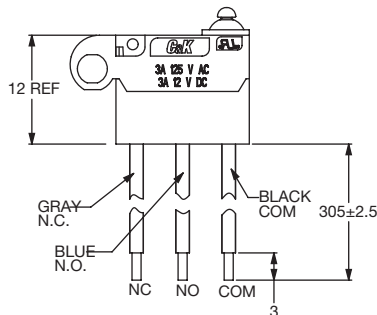

Standard Wire: 20 AWG UL 1007

Available options - must specify

J - 20AWG UL1007 (Standard)

K - 22AWG UL1430

W - 24AWG UL1061

N - 26AWG UL1330

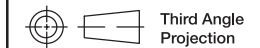

Dimensions are shown: mm
Specifications and dimensions subject to change

ZMSM Series with Mounting Hole Subminiature Snap-acting Switches (IP65)

MOUNTING STYLES

M NO SUPPORT POSTS

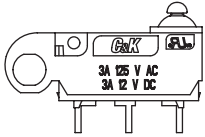

MODEL SHOWN:
ZMSMHXXXP00PMC

L TWO SUPPORT POSTS LEFT

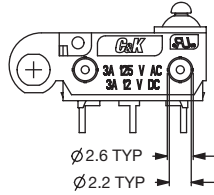
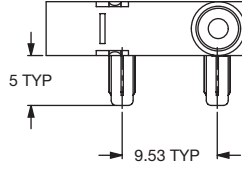

POSTS LEFT
MODEL SHOWN:
ZMSMHXXXP00PLC

R TWO SUPPORT POSTS RIGHT

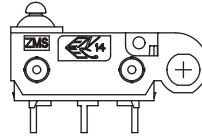
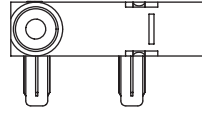

POSTS RIGHT
MODEL SHOWN:
ZMSMHXXXP00PRC

T ONE SUPPORT POST
LEFT & RIGHT

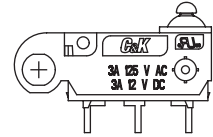
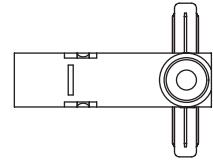

LEFT & RIGHT
MODEL SHOWN:
ZMSMHXXXP00PTC

Snap-acting

CIRCUITRY

- C** SPDT (Single Pole, Double Throw)
- W** SPST, NC (Single Pole, Single Throw, Normally Closed)
- Y** SPST, NO (Single Pole, Single Throw, Normally Open)



Third Angle
Projection

Dimensions are shown: mm
Specifications and dimensions subject to change

Компания «Life Electronics» занимается поставками электронных компонентов импортного и отечественного производства от производителей и со складов крупных дистрибьюторов Европы, Америки и Азии.

С конца 2013 года компания активно расширяет линейку поставок компонентов по направлению коаксиальный кабель, кварцевые генераторы и конденсаторы (керамические, пленочные, электролитические), за счёт заключения дистрибьюторских договоров

Мы предлагаем:

- Конкурентоспособные цены и скидки постоянным клиентам.
- Специальные условия для постоянных клиентов.
- Подбор аналогов.
- Поставку компонентов в любых объемах, удовлетворяющих вашим потребностям.
- Приемлемые сроки поставки, возможна ускоренная поставка.
- Доставку товара в любую точку России и стран СНГ.
- Комплексную поставку.
- Работу по проектам и поставку образцов.
- Формирование склада под заказчика.
- Сертификаты соответствия на поставляемую продукцию (по желанию клиента).
- Тестирование поставляемой продукции.
- Поставку компонентов, требующих военную и космическую приемку.
- Входной контроль качества.
- Наличие сертификата ISO.

В составе нашей компании организован Конструкторский отдел, призванный помогать разработчикам, и инженерам.

Конструкторский отдел помогает осуществить:

- Регистрацию проекта у производителя компонентов.
- Техническую поддержку проекта.
- Защиту от снятия компонента с производства.
- Оценку стоимости проекта по компонентам.
- Изготовление тестовой платы монтаж и пусконаладочные работы.



Тел: +7 (812) 336 43 04 (многоканальный)
Email: org@lifeelectronics.ru