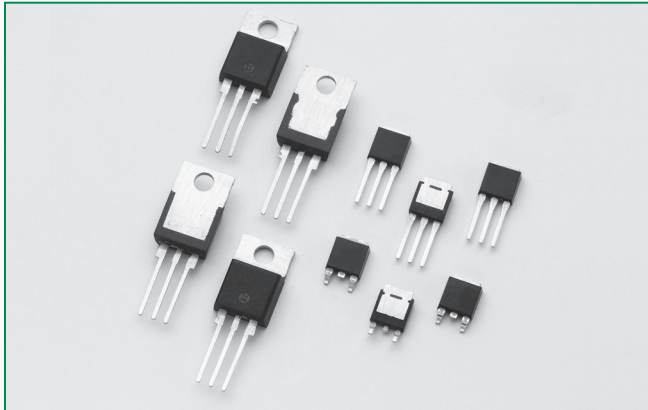


**RoHS** **Sxx06xSx & Sxx06x Series**



Agency Approval	
Agency	Agency File Number
	L Package: E71639

Main Features		
Symbol	Value	Unit
$I_{T(RMS)}$	6	A
$V_{DRM}/V_{RRM}$	400 to 1000	V
$I_{GT}$	0.2 to 15	mA

**Description**

Excellent unidirectional switches for phase control applications such as heating and motor speed controls. Sensitive gate SCRs are easily triggered with microAmps of current as furnished by sense coils, proximity switches, and microprocessors. Standard phase control SCRs are triggered with few milliamperes of current at less than 1.5V potential.

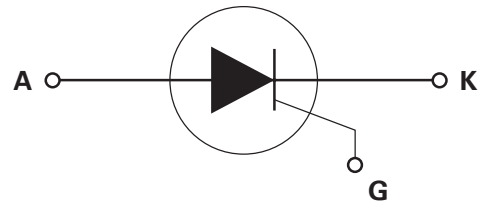
**Features & Benefits**

- RoHS compliant
- Glass – passivated junctions
- Voltage capability up to 1000 V
- Surge capability up to 100 A

**Applications**

Typical applications are capacitive discharge systems for strobe lights, nailers, staplers and gas engine ignition. Also controls for power tools, home/brown goods and white goods appliances. Internally constructed isolated packages are offered for ease of heat sinking with highest isolation voltage.

**Schematic Symbol**



**Absolute Maximum Ratings — Sensitive SCRs**

Symbol	Parameter	Test Conditions		Value	Unit
$I_{T(RMS)}$	RMS on-state current	Sxx06LSy	$T_c = 80^\circ\text{C}$	6	A
		Sxx06RSy Sxx06DSy Sxx06Vsy	$T_c = 95^\circ\text{C}$		
$I_{T(AV)}$	Average on-state current	Sxx06LSy	$T_c = 80^\circ\text{C}$	3.8	A
		Sxx06RSy Sxx06DSy Sxx06Vsy	$T_c = 95^\circ\text{C}$		
$I_{TSM}$	Peak non-repetitive surge current	single half cycle; $f = 50\text{Hz}$ ; $T_J$ (initial) = $25^\circ\text{C}$		83	A
		single half cycle; $f = 60\text{Hz}$ ; $T_J$ (initial) = $25^\circ\text{C}$		100	
$I^2t$	$I^2t$ Value for fusing	$t_p = 8.3 \text{ ms}$		41	$\text{A}^2\text{s}$
$di/dt$	Critical rate of rise of on-state current	$f = 60\text{Hz}$ ; $T_J = 110^\circ\text{C}$		100	$\text{A}/\mu\text{s}$
$I_{GTM}$	Peak gate current	$T_J = 110^\circ\text{C}$		1	A
$P_{G(AV)}$	Average gate power dissipation	$T_J = 110^\circ\text{C}$		0.1	W
$T_{stg}$	Storage temperature range			-40 to 150	$^\circ\text{C}$
$T_J$	Operating junction temperature range			-40 to 110	$^\circ\text{C}$

Note: xx = voltage, y = sensitivity

**Absolute Maximum Ratings — Standard SCRs**

Symbol	Parameter	Test Conditions		Value	Unit
$I_{T(RMS)}$	RMS on-state current	Sxx06L	$T_c = 100^\circ\text{C}$	6	A
		Sxx06R Sxx06D Sxx06V	$T_c = 110^\circ\text{C}$		
$I_{T(AV)}$	Average on-state current	Sxx06L	$T_c = 100^\circ\text{C}$	3.8	A
		Sxx06R Sxx06D Sxx06V	$T_c = 110^\circ\text{C}$		
$I_{TSM}$	Peak non-repetitive surge current	single half cycle; $f = 50\text{Hz}$ ; $T_J$ (initial) = $25^\circ\text{C}$		83	A
		single half cycle; $f = 60\text{Hz}$ ; $T_J$ (initial) = $25^\circ\text{C}$		100	
$I^2t$	$I^2t$ value for fusing	$t_p = 8.3 \text{ ms}$		41	$\text{A}^2\text{s}$
$di/dt$	Critical rate-of-rise of on-state current	$f = 60\text{Hz}$ ; $T_J = 125^\circ\text{C}$		100	$\text{A}/\mu\text{s}$
$I_{GTM}$	Peak gate current	$T_J = 125^\circ\text{C}$		2	A
$P_{G(AV)}$	Average gate power dissipation	$T_J = 125^\circ\text{C}$		0.5	W
$T_{stg}$	Storage temperature range			-40 to 150	$^\circ\text{C}$
$T_J$	Operating junction temperature range			-40 to 125	$^\circ\text{C}$

Note: xx = voltage

**Electrical Characteristics ( $T_J = 25^\circ\text{C}$ , unless otherwise specified) — Sensitive SCRs**

Symbol	Test Conditions		Value		Unit
			Sxx06xS2	Sxx06xS3	
$I_{GT}$	$V_D = 6V$ $R_L = 100 \Omega$	MAX.	200	500	$\mu\text{A}$
$V_{GT}$		MAX.	0.8		V
dv/dt	$V_D = V_{DRM}$ ; $R_{GK} = 1k\Omega$ ; $T_J = 110^\circ\text{C}$	TYP.	8		V/ $\mu\text{s}$
$V_{GD}$	$V_D = V_{DRM}$ $R_L = 3.3 k\Omega$ $T_J = 110^\circ\text{C}$	MIN.	0.2		V
$V_{GRM}$	$I_{GR} = 10\mu\text{A}$	MIN.	6		V
$I_H$	$I_T = 20\text{mA}$ (initial)	MAX.	6	8	mA
$t_q$	$I_T = 2\text{A}$ ; $t_p = 50\mu\text{s}$ ; dv/dt=5V/ $\mu\text{s}$ ; di/dt=-30A/ $\mu\text{s}$	MAX.	50	45	$\mu\text{s}$
$t_{gt}$	$I_G = 2 \times I_{GT}$ PW = 15 $\mu\text{s}$ $I_T = 12\text{A}$	TYP.	4	5	$\mu\text{s}$

Note: xx = voltage, x = package

**Electrical Characteristics ( $T_J = 25^\circ\text{C}$ , unless otherwise specified) — Standard SCRs**

Symbol	Test Conditions			Value	Unit
				Sxx06x	
$I_{GT}$	$V_D = 12V$ $R_L = 60 \Omega$		MAX.	15	mA
$V_{GT}$			MAX.	1.5	V
dv/dt	$V_D = V_{DRM}$ ; gate open; $T_J = 100^\circ\text{C}$	400V	MIN.	350	V/ $\mu\text{s}$
		600V		300	
		800V		250	
		1000V		100	
	$V_D = V_{DRM}$ ; gate open; $T_J = 125^\circ\text{C}$	400V		250	
		600V		225	
800V		200			
$V_{GD}$	$V_D = V_{DRM}$ $R_L = 3.3 k\Omega$ $T_J = 125^\circ\text{C}$		MIN.	0.2	V
$I_H$	$I_T = 200\text{mA}$ (initial)		MAX.	30	mA
$t_q$	$I_T = 2\text{A}$ ; $t_p = 50\mu\text{s}$ ; dv/dt=5V/ $\mu\text{s}$ ; di/dt=-30A/ $\mu\text{s}$		MAX.	35	$\mu\text{s}$
$t_{gt}$	$I_G = 2 \times I_{GT}$ PW = 15 $\mu\text{s}$ $I_T = 12\text{A}$		TYP.	2	$\mu\text{s}$

Note: xx = voltage, x = package

### Static Characteristics

Symbol	Test Conditions			Value	Unit	
$V_{TM}$	$I_T = 12A; t_p = 380 \mu s$			MAX.	1.6	V
$I_{DRM} / I_{RRM}$	Sxx06xyy	$T_J = 25^\circ C$	400 – 600V	MAX.	5	$\mu A$
		$T_J = 110^\circ C$	400 – 600V		250	
	Sxx06x	$T_J = 25^\circ C$	400 – 800V		10	
			1000V		20	
		$T_J = 100^\circ C$	400 – 800V		200	
			1000V		3000	
$T_J = 125^\circ C$	400 – 800V	500				

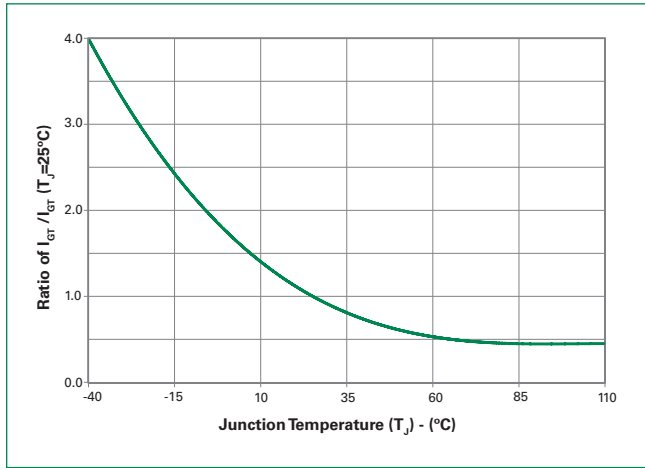
Note: xx = voltage, x = package, yy = sensitivity

### Thermal Resistances

Symbol	Parameter	Value	Unit	
$R_{\theta(J-C)}$	Junction to case (AC)	Sxx06RSy	2.6	$^\circ C/W$
		Sxx06LSy	4.3	
		Sxx06Vsy	2.4	
		Sxx06DSy	1.8	
		Sxx06R	2.5	
		Sxx06L	4.0	
		Sxx06V	2.3	
		Sxx06D	1.7	
$R_{\theta(J-A)}$	Junction to ambient	Sxx06RSy	40	$^\circ C/W$
		Sxx06LSy	65	
		Sxx06Vsy	85	
		Sxx06R	40	
		Sxx06L	50	
		Sxx06V	70	

Note: xx = voltage, y = sensitivity

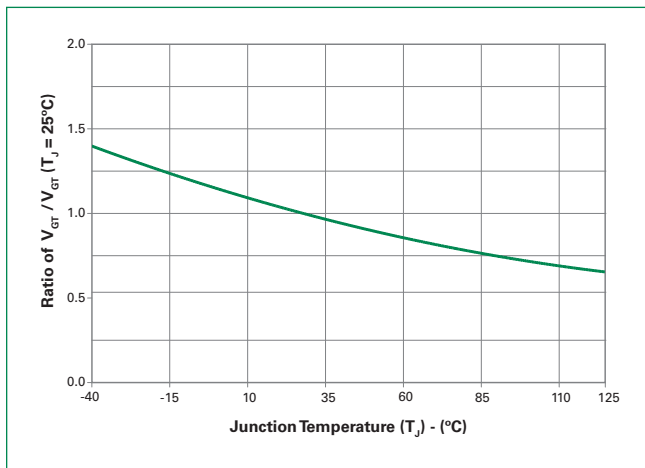
**Figure 1: Normalized DC Gate Trigger Current vs. Junction Temperature (Sensitive SCR)**



**Figure 2: Normalized DC Gate Trigger Current vs. Junction Temperature (Standard SCR)**



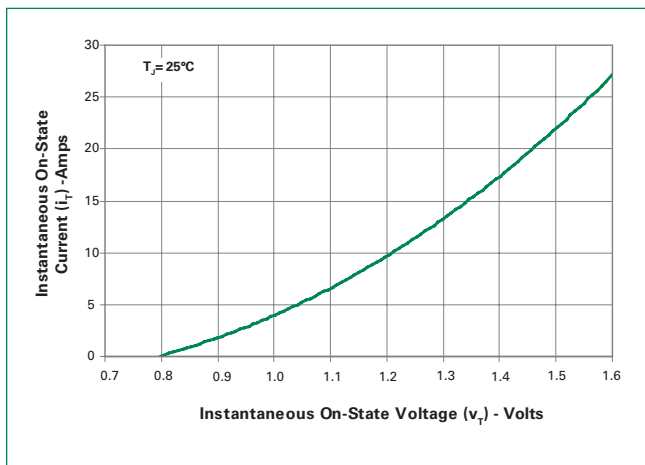
**Figure 3: Normalized DC Gate Trigger Voltage vs. Junction Temperature**



**Figure 4: Normalized DC Holding Current vs. Junction Temperature**



**Figure 5: On-State Current vs. On-State Voltage (Typical)**



**Figure 6: Power Dissipation (Typical) vs. RMS On-State Current**



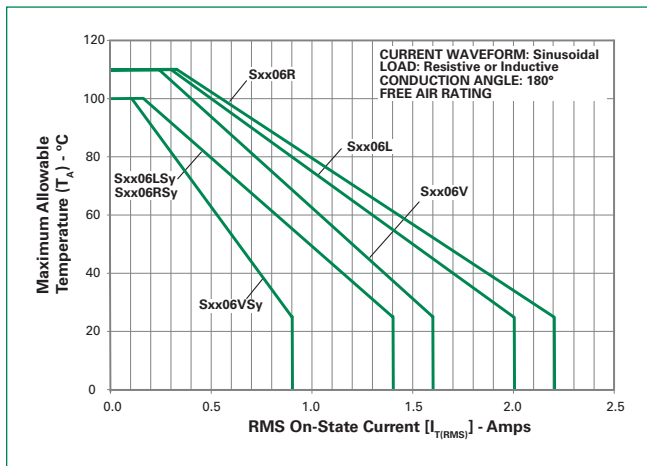
**Figure 7: Maximum Allowable Case Temperature vs. RMS On-State Current**



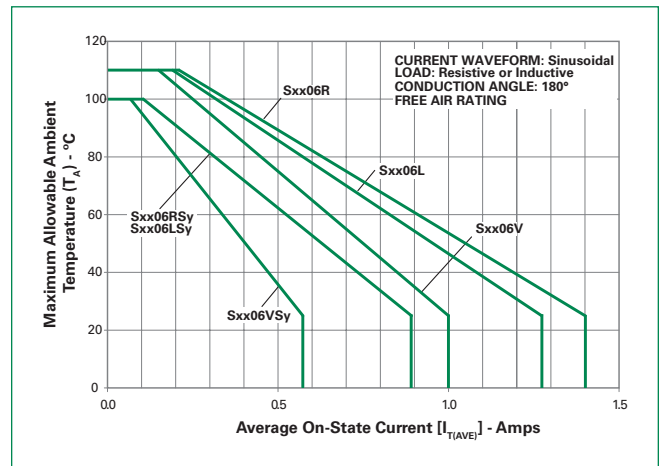
**Figure 8: Maximum Allowable Case Temperature vs. Average On-State Current**



**Figure 9: Maximum Allowable Ambient Temperature vs. RMS On-State Current**

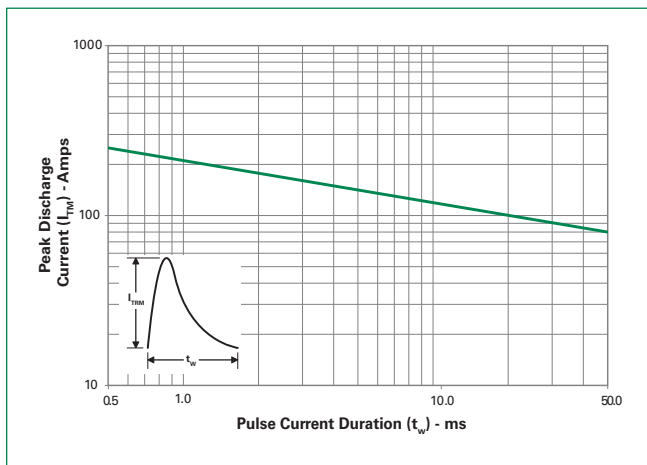


**Figure 10: Maximum Allowable Ambient Temperature vs. Average On-State Current**



Note: xx = voltage, y = sensitivity

**Figure 11: Peak Capacitor Discharge Current**



**Figure 12: Peak Capacitor Discharge Current Derating**

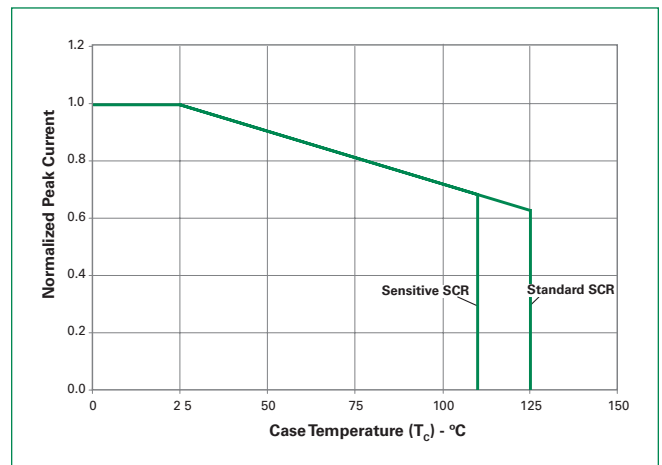
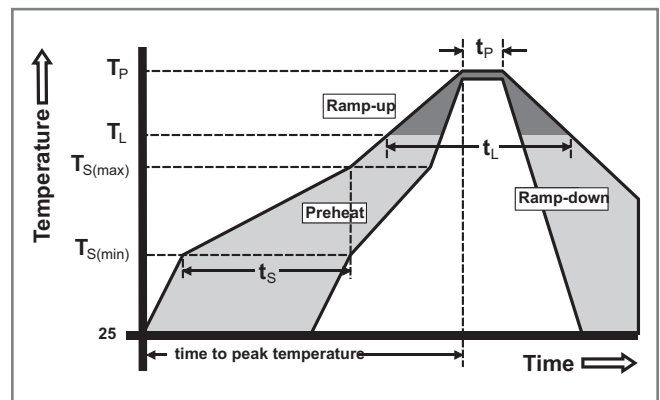


Figure 13: Surge Peak On-State Current vs. Number of Cycles



Soldering Parameters

Reflow Condition	Pb – Free assembly	
Pre Heat	- Temperature Min ( $T_{s(min)}$ )	150°C
	- Temperature Max ( $T_{s(max)}$ )	200°C
	- Time (min to max) ( $t_s$ )	60 – 180 secs
Average ramp up rate (Liquidus Temp) ( $T_L$ ) to peak	5°C/second max	
$T_{s(max)}$ to $T_L$ - Ramp-up Rate	5°C/second max	
Reflow	- Temperature ( $T_L$ ) (Liquidus)	217°C
	- Temperature ( $t_L$ )	60 – 150 seconds
Peak Temperature ( $T_p$ )	260 <sup>+0/-5</sup> °C	
Time within 5°C of actual peak Temperature ( $t_p$ )	20 – 40 seconds	
Ramp-down Rate	5°C/second max	
Time 25°C to peak Temperature ( $T_p$ )	8 minutes Max.	
Do not exceed	280°C	



### Physical Specifications

<b>Terminal Finish</b>	100% Matte Tin-plated
<b>Body Material</b>	UL recognized epoxy meeting flammability classification 94V-0
<b>Lead Material</b>	Copper Alloy

### Design Considerations

Careful selection of the correct device for the application's operating parameters and environment will go a long way toward extending the operating life of the Thyristor. Good design practice should limit the maximum continuous current through the main terminals to 75% of the device rating. Other ways to ensure long life for a power discrete semiconductor are proper heat sinking and selection of voltage ratings for worst case conditions. Overheating, overvoltage (including dv/dt), and surge currents are the main killers of semiconductors. Correct mounting, soldering, and forming of the leads also help protect against component damage.

### Environmental Specifications

Test	Specifications and Conditions
<b>AC Blocking</b>	MIL-STD-750, M-1040, Cond A Applied Peak AC voltage @ 125°C for 1008 hours
<b>Temperature Cycling</b>	MIL-STD-750, M-1051, 100 cycles; -40°C to +150°C; 15-min dwell-time
<b>Temperature/Humidity</b>	EIA / JEDEC, JESD22-A101 1008 hours; 320V - DC: 85°C; 85% rel humidity
<b>High Temp Storage</b>	MIL-STD-750, M-1031, 1008 hours; 150°C
<b>Low-Temp Storage</b>	1008 hours; -40°C
<b>Thermal Shock</b>	MIL-STD-750, M-1056 10 cycles; 0°C to 100°C; 5-min dwell-time at each temperature; 10 sec (max) transfer time between temperature
<b>Autoclave</b>	EIA / JEDEC, JESD22-A102 168 hours (121°C at 2 ATMs) and 100% R/H
<b>Resistance to Solder Heat</b>	MIL-STD-750 Method 2031
<b>Solderability</b>	ANSI/J-STD-002, category 3, Test A
<b>Lead Bend</b>	MIL-STD-750, M-2036 Cond E

### Product Selector

Part Number	Voltage				Gate Sensitivity	Type	Package
	400V	600V	800V	1000V			
Sxx06RS2	X	X			0.2mA	Sensitive SCR	TO-220R
Sxx06LS2	X	X			0.2mA	Sensitive SCR	TO-220L
Sxx06VS2	X	X			0.2mA	Sensitive SCR	TO-251
Sxx06DS2	X	X			0.2mA	Sensitive SCR	TO-252
Sxx06RS3	X	X			0.5mA	Sensitive SCR	TO-220R
Sxx06LS3	X	X			0.5mA	Sensitive SCR	TO-220L
Sxx06VS3	X	X			0.5mA	Sensitive SCR	TO-251
Sxx06DS3	X	X			0.5mA	Sensitive SCR	TO-252
Sxx06R	X	X	X	X	15mA	Standard SCR	TO-220R
Sxx06L	X	X	X	X	15mA	Standard SCR	TO-220L
Sxx06V	X	X	X	X	15mA	Standard SCR	TO-251
Sxx06D	X	X	X	X	15mA	Standard SCR	TO-252

Note: xx = voltage



**Dimensions — TO-251AA (V/I-Package) — V/I-PAK Through Hole**



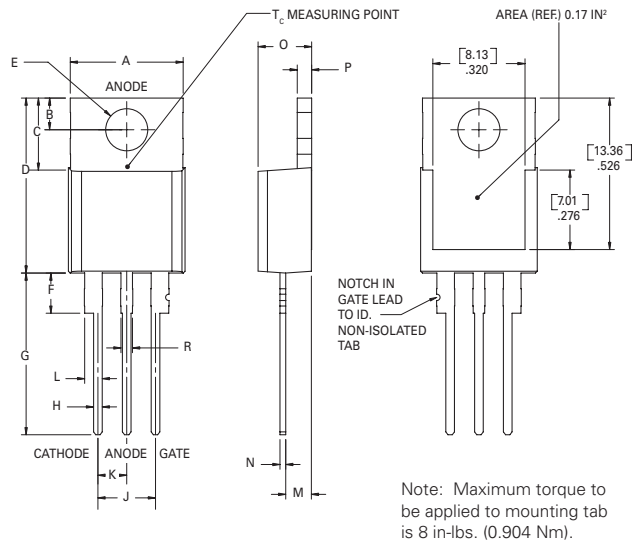
Dimension	Inches			Millimeters		
	Min	Typ	Max	Min	Typ	Max
A	0.040	0.044	0.050	1.02	1.11	1.27
B	0.235	0.242	0.245	5.97	6.15	6.22
C	0.350	0.361	0.375	8.89	9.18	9.53
D	0.205	0.208	0.213	5.21	5.29	5.41
E	0.255	0.262	0.265	6.48	6.66	6.73
F	0.027	0.031	0.033	0.69	0.80	0.84
G	0.087	0.090	0.093	2.21	2.28	2.36
H	0.085	0.092	0.095	2.16	2.34	2.41
I	0.176	0.180	0.184	4.47	4.57	4.67
J	0.018	0.020	0.023	0.46	0.51	0.58
K	0.038	0.040	0.044	0.97	1.01	1.12
L	0.018	0.020	0.023	0.46	0.52	0.58
P	0.042	0.047	0.052	1.06	1.20	1.32
Q	0.034	0.039	0.044	0.86	1.00	1.11
R	0.034	0.039	0.044	0.86	1.00	1.11
S	0.074	0.079	0.084	1.86	2.00	2.11

**Dimensions — TO-252AA (D-Package) — D-PAK Surface Mount**



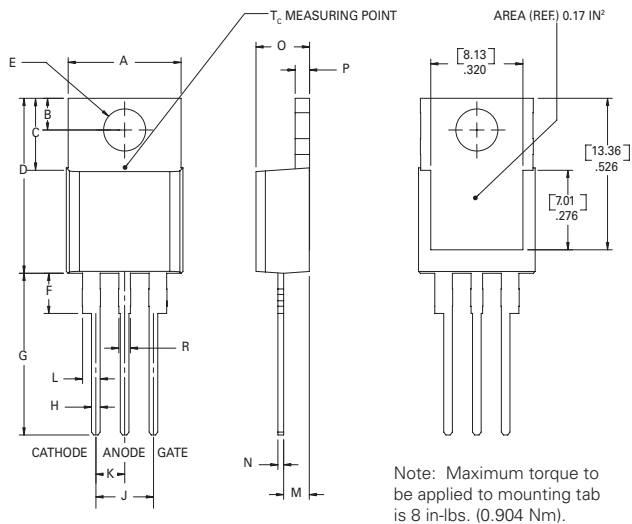
Dimension	Inches			Millimeters		
	Min	Typ	Max	Min	Typ	Max
A	0.040	0.043	0.050	1.02	1.09	1.27
B	0.235	0.243	0.245	5.97	6.16	6.22
C	0.106	0.108	0.113	2.69	2.74	2.87
D	0.205	0.208	0.213	5.21	5.29	5.41
E	0.255	0.262	0.265	6.48	6.65	6.73
F	0.027	0.031	0.033	0.69	0.80	0.84
G	0.087	0.090	0.093	2.21	2.28	2.36
H	0.085	0.092	0.095	2.16	2.33	2.41
I	0.176	0.179	0.184	4.47	4.55	4.67
J	0.018	0.020	0.023	0.46	0.51	0.58
K	0.038	0.040	0.044	0.97	1.02	1.12
L	0.018	0.020	0.023	0.46	0.51	0.58
M	0.000	0.000	0.004	0.00	0.00	0.10
N	0.021	0.026	0.027	0.53	0.67	0.69
O	0°	0°	5°	0°	0°	5°
P	0.042	0.047	0.052	1.06	1.20	1.32
Q	0.034	0.039	0.044	0.86	1.00	1.11

**Dimensions — TO-220AB (R-Package) — Non-Isolated Mounting Tab Common with Center Lead**



Dimension	Inches		Millimeters	
	Min	Max	Min	Max
A	0.380	0.420	9.65	10.67
B	0.105	0.115	2.67	2.92
C	0.230	0.250	5.84	6.35
D	0.590	0.620	14.99	15.75
E	0.142	0.147	3.61	3.73
F	0.110	0.130	2.79	3.30
G	0.540	0.575	13.72	14.61
H	0.025	0.035	0.64	0.89
J	0.195	0.205	4.95	5.21
K	0.095	0.105	2.41	2.67
L	0.060	0.075	1.52	1.91
M	0.085	0.095	2.16	2.41
N	0.018	0.024	0.46	0.61
O	0.178	0.188	4.52	4.78
P	0.045	0.060	1.14	1.52
R	0.038	0.048	0.97	1.22

**Dimensions — TO-220AB (L-Package) — Isolated Mounting Tab**



Dimension	Inches		Millimeters	
	Min	Max	Min	Max
A	0.380	0.420	9.65	10.67
B	0.105	0.115	2.67	2.92
C	0.230	0.250	5.84	6.35
D	0.590	0.620	14.99	15.75
E	0.142	0.147	3.61	3.73
F	0.110	0.130	2.79	3.30
G	0.540	0.575	13.72	14.61
H	0.025	0.035	0.64	0.89
J	0.195	0.205	4.95	5.21
K	0.095	0.105	2.41	2.67
L	0.060	0.075	1.52	1.91
M	0.085	0.095	2.16	2.41
N	0.018	0.024	0.46	0.61
O	0.178	0.188	4.52	4.78
P	0.045	0.060	1.14	1.52
R	0.038	0.048	0.97	1.22

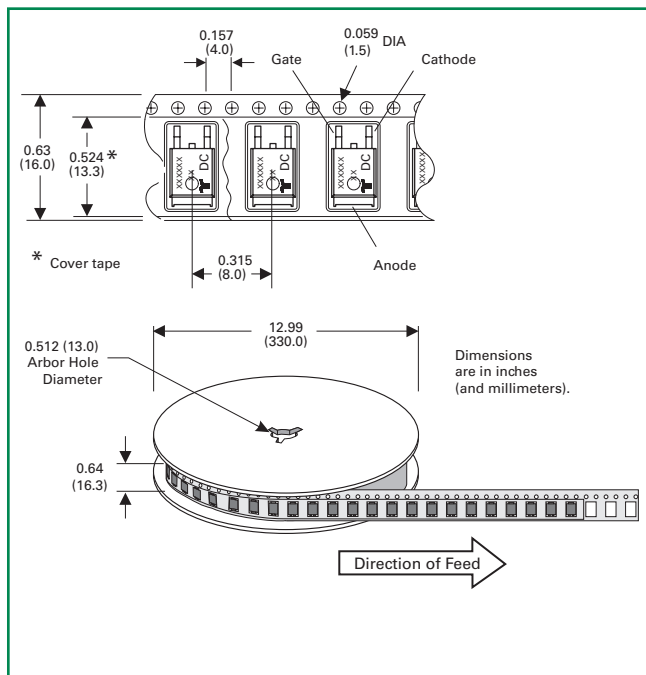
### Packing Options

Part Number	Marking	Weight	Packing Mode	Base Quantity
Sxx06L/Ryy	Sxx06L/Ryy	2.2 g	Bulk	500
Sxx06L/RyyTP	Sxx06L/Ryy	2.2 g	Tube	500 (50 per tube)
Sxx06DyyTP	Sxx06Dyy	0.3 g	Tube	750 (75 per tube)
Sxx06DyyRP	Sxx06Dyy	0.3 g	Embossed Carrier	2500
Sxx06VyyTP	Sxx06Vyy	0.4 g	Tube	750 (75 per tube)
Sxx06L/R	Sxx06L/R	2.2 g	Bulk	500
Sxx06L/RTP	Sxx06L/R	2.2 g	Tube	500 (50 per tube)
Sxx06DTP	Sxx06D	0.3 g	Tube	750 (75 per tube)
Sxx06DRP	Sxx06D	0.3 g	Embossed Carrier	2500
Sxx06VTP	Sxx06V	0.4 g	Tube	750 (75 per tube)

Note: xx = Voltage; yy = Sensitivity

### TO-252 Embossed Carrier Reel Pack (RP) Specs

#### Meets all EIA-481-2 Standards

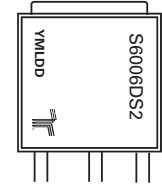


### Part Marking System

TO-220 AB – (R Package)



TO-251AA – (V Package)  
TO-252AA – (D Package)



TO-220 AB – (L Package)



### Part Numbering System



Компания «Life Electronics» занимается поставками электронных компонентов импортного и отечественного производства от производителей и со складов крупных дистрибьюторов Европы, Америки и Азии.

С конца 2013 года компания активно расширяет линейку поставок компонентов по направлению коаксиальный кабель, кварцевые генераторы и конденсаторы (керамические, пленочные, электролитические), за счёт заключения дистрибьюторских договоров

Мы предлагаем:

- Конкурентоспособные цены и скидки постоянным клиентам.
- Специальные условия для постоянных клиентов.
- Подбор аналогов.
- Поставку компонентов в любых объемах, удовлетворяющих вашим потребностям.
- Приемлемые сроки поставки, возможна ускоренная поставка.
- Доставку товара в любую точку России и стран СНГ.
- Комплексную поставку.
- Работу по проектам и поставку образцов.
- Формирование склада под заказчика.
- Сертификаты соответствия на поставляемую продукцию (по желанию клиента).
- Тестирование поставляемой продукции.
- Поставку компонентов, требующих военную и космическую приемку.
- Входной контроль качества.
- Наличие сертификата ISO.

В составе нашей компании организован Конструкторский отдел, призванный помогать разработчикам, и инженерам.

Конструкторский отдел помогает осуществить:

- Регистрацию проекта у производителя компонентов.
- Техническую поддержку проекта.
- Защиту от снятия компонента с производства.
- Оценку стоимости проекта по компонентам.
- Изготовление тестовой платы монтаж и пусконаладочные работы.



Тел: +7 (812) 336 43 04 (многоканальный)

Email: [org@lifeelectronics.ru](mailto:org@lifeelectronics.ru)