

General Specifications

Electrical Capacity (Resistive Load)

Power Level: 3A @ 250V AC

Other Ratings

| | |
|----------------------------------|---|
| Contact Resistance: | 20 milliohms maximum |
| Insulation Resistance: | 1,000 megohms minimum @ 500V DC |
| Dielectric Strength: | 1,000V AC minimum between contacts for 1 minute minimum; 1,500V AC minimum between contacts & case for 1 minute minimum |
| Mechanical Life: | 30,000 cycles minimum |
| Electrical Life: | 10,000 cycles minimum |
| Static Capability: | Withstands 15 kilovolts minimum ESD minimum (for CKM models only) |
| Nominal Operating Torque: | 16mm Bushing (CKM models): .04 mNm (5.67 oz•in) for Flat Key .08 mNm (11.33 oz•in) for Tubular Key 19mm Bushing (CKL models): .05 mNm (7.08 oz•in) for Flat Key .07 mNm (9.91 oz•in) for Tubular Key |
| Contact Timing: | Break-before-make |
| Angle of Throw: | 90° for 2-position & 45° for 3-position |

Materials & Finishes

| | |
|---------------------------|--|
| Keys for CKM: | Brass with nickel plating with ABS handle |
| Keys for CKL: | Brass with nickel plating for tubular key; brass with chrome plating for flat key |
| Housing/Bushing: | Glass fiber reinforced PBT for CKM models; zinc alloy with chrome plating for CKL |
| Base: | LCP (Liquid Crystal Polymer) |
| Contact Terminals: | Copper with silver plating |
| Common Terminals: | Copper with silver plating |
| Movable Contactor: | Copper |
| Movable Contacts: | Silver |

Environmental Data

| | |
|-------------------------------------|--|
| Operating Temperature Range: | -25°C through +70°C (-13°F through +158°F) |
| Humidity: | 90 ~ 95% humidity for 240 hours @ 40°C (104°F) for CKM; 90 ~ 95% humidity for 96 hours @ 40°C (104°F) for CKL |
| Vibration: | 10 ~ 55Hz with peak-to-peak amplitude of 1.5mm for CKM or 0.7mm for CKL traversing the frequency range & returning in 1 minute; 3 right angled directions for 2 hours |
| Shock: | 50G (490m/s ²) acceleration for CKM; 30G (294m/s ²) acceleration for CKL; (CKM & CKL tested in 6 right angled directions, with 5 shocks in each direction) |

Installation

| | |
|--|--|
| Mounting Torque: | 1.5 Nm (13.28 lb•in) maximum |
| Soldering Time & Temperature: | Manual Soldering: See Profile A in Supplement section. |

Distinctive Characteristics

High insulating material for 16mm CKM models withstands over 15 kilovolts of electrostatic discharge, thus providing antistatic feature.

Rugged, die cast housing 19mm CKL models designed for higher security requirements.

Vertically rotating switching mechanism combines with self-cleaning sliding contacts for high reliability and long operating life.

16mm and 19mm diameter bushings available.

CKL and CKM on-off-on models with tubular keys have push-and-lock mechanism which allows contactor to drop and slide over stationary contacts.

Available in both flat and tubular key styles; flat key is reversible for easier setting.

Epoxy sealed terminals prevent entry of flux and other contaminants.

Interior construction provides seal for contact area.

High dielectric strength of 1,500 volts between contacts and case.



Actual Size CKM with Tubular Key



Toggles

Rockers

Pushbuttons

Illuminated PB

Programmable

F
Keylocks

Rotaries

Slides

Tactiles

Tilt

Touch

Indicators

Accessories

Supplement

TYPICAL SWITCH ORDERING EXAMPLE



DESCRIPTION FOR TYPICAL ORDERING EXAMPLE

CKM12AFW01



Toggles
 Rockers
 Pushbuttons
 Illuminated PB
 Programmable
 Keylocks
 Rotaries
 Slides
 Tactiles
 Tilt
 Touch
 Indicators
 Accessories
 Supplement

POLES, CIRCUITS & KEY-REMOVABLE POSITIONS

| Pole & Throw | Model | Key Positions | | | Connected Terminals (Terminal numbers are on switch) | | | Schematic | ☉ = Key Removable ● = Not Removable ✓ = Maximum Arc |
|--------------|------------------|---------------|-------|-------|---|-------|-------|-----------|---|
| | | Pos 1 | Pos 2 | Pos 3 | Pos 1 | Pos 2 | Pos 3 | | |
| SPDT | CKM12A CKL12A | ON | NONE | ON | COM-1 | — | COM-2 | | |
| SPDT | CKM12B CKL12B | ON | NONE | ON | COM-1 | — | COM-2 | | |
| SPDT | CKM13E CKL13E | ON | OFF | ON | COM-1 | OPEN | COM-2 | | |

KEYS

F Flat Key

AT4147 for CKM 16mm

Brass with Nickel Plating key base & ABS key handle

AT4153 for CKL 19mm

Brass with Chrome Plating (crosshatch texture on handle)

One key provided with each switch (no master key available)
For ordering additional keys, indicate the same key number that is engraved on the face of your switch.

Randomly assigned key number (001 through 010 for CKM models & 001 through 025 for CKL models).

Typical Key Ordering Example: AT4153-001

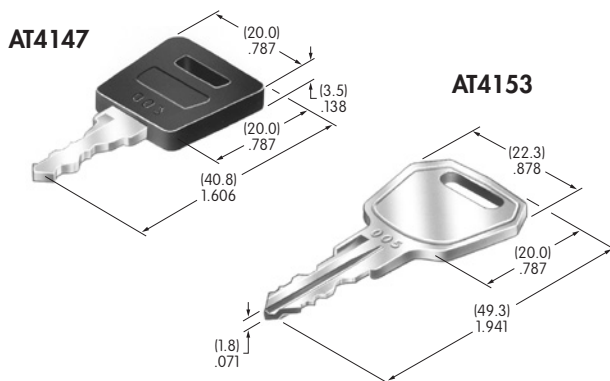

T Tubular Key (must be pressed inward to actuate)

AT4146 for CKM 16mm

Brass with Nickel Plating key base & ABS key handle

AT4152 for CKL 19mm

Brass with Nickel Plating (smooth)

One key provided with each switch (no master key available)
For ordering additional keys, indicate the same key number that is engraved on the face of your switch.

Randomly assigned key number (001 through 025 for CKM models & 001 through 050 for CKL models).

Typical Key Ordering Example: AT4146-001



CONTACT MATERIALS, RATINGS & TERMINALS

W Silver over Silver
Power Level 3A @ 250V AC

01 Solder Lug Terminals

Solder Lug Terminal
for CKM



Solder Lug Terminal
for CKL



TYPICAL SWITCH DIMENSIONS

16mm Bushing • Flat Key



**90°
Angular
Throw**



**45°
Angular
Throw**

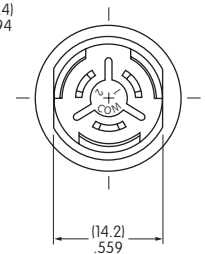

CKM12AFW01

16mm Bushing • Tubular Key



**90°
Angular
Throw**

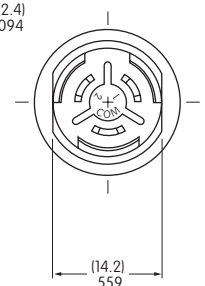
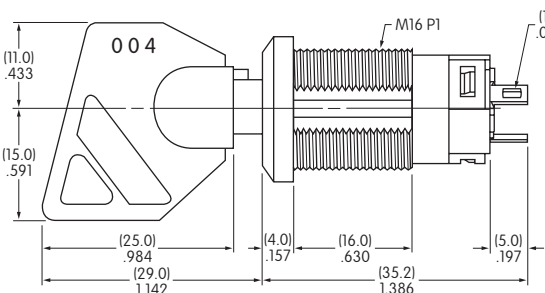

**45°
Angular
Throw**

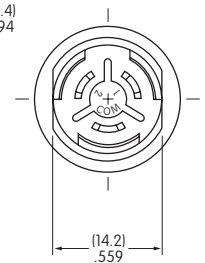
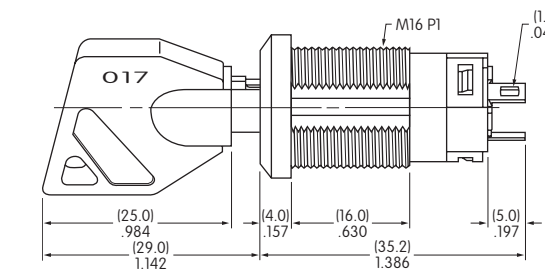

CKM13ETW01

PANEL CUTOUT & STANDARD HARDWARE FOR 16MM BUSHING

Maximum Effective
Panel Thickness:
.469" (11.9mm)



**AT016
16mm Hex Mounting Nut
for CKM**

1 included with each switch
Steel



TYPICAL SWITCH DIMENSIONS

19mm Bushing • Flat Key

**90°
Angular
Throw**

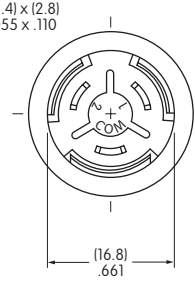
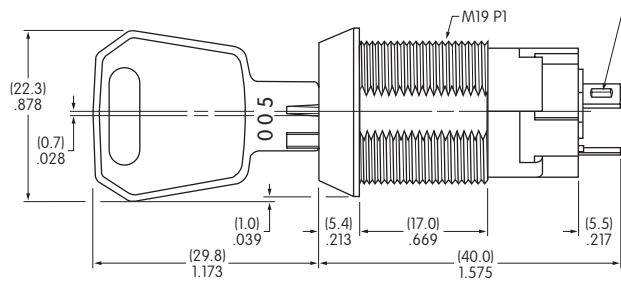

CKL12AFW01

**45°
Angular
Throw**

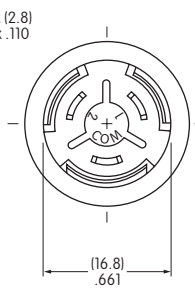
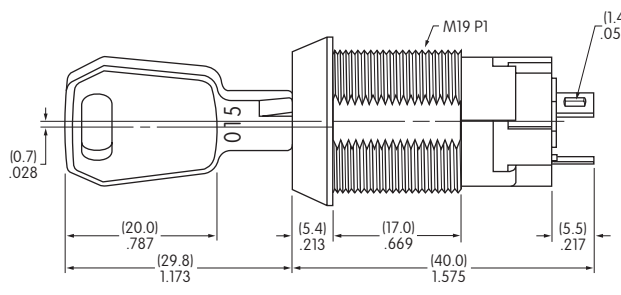

**90°
Angular
Throw**

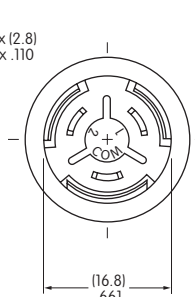
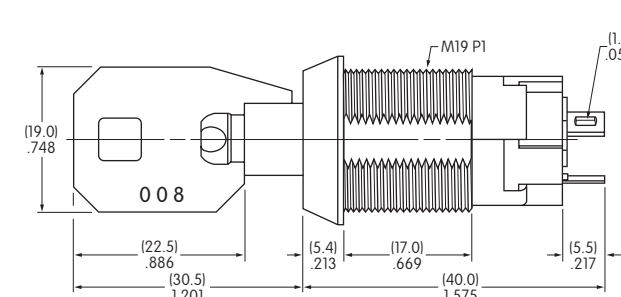
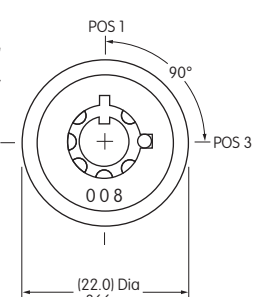

CKL13ETW01

**45°
Angular
Throw**

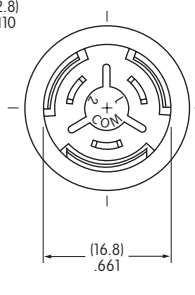
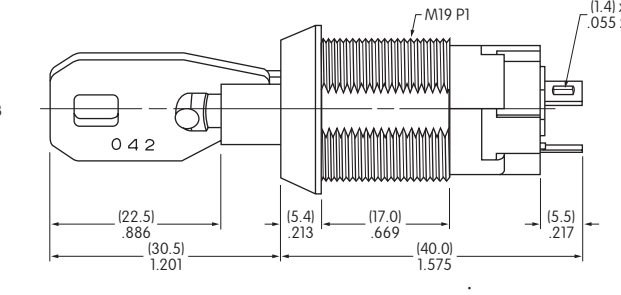
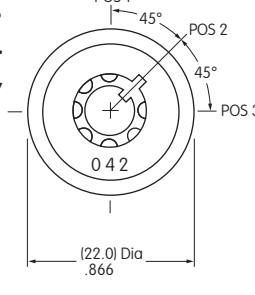

PANEL CUTOUT & STANDARD HARDWARE FOR 19MM BUSHING

Maximum Effective
Panel Thickness:
.496" (12.6mm)

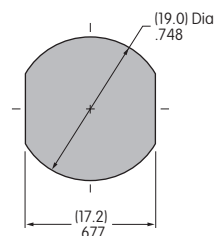

**AT019
19mm Hex Mounting Nut
for CKL**

1 included with each switch
Steel

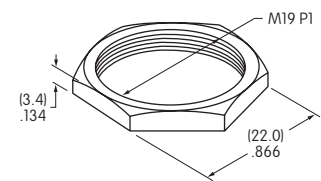

Компания «Life Electronics» занимается поставками электронных компонентов импортного и отечественного производства от производителей и со складов крупных дистрибьюторов Европы, Америки и Азии.

С конца 2013 года компания активно расширяет линейку поставок компонентов по направлению коаксиальный кабель, кварцевые генераторы и конденсаторы (керамические, пленочные, электролитические), за счёт заключения дистрибьюторских договоров

Мы предлагаем:

- Конкурентоспособные цены и скидки постоянным клиентам.
- Специальные условия для постоянных клиентов.
- Подбор аналогов.
- Поставку компонентов в любых объемах, удовлетворяющих вашим потребностям.
- Приемлемые сроки поставки, возможна ускоренная поставка.
- Доставку товара в любую точку России и стран СНГ.
- Комплексную поставку.
- Работу по проектам и поставку образцов.
- Формирование склада под заказчика.
- Сертификаты соответствия на поставляемую продукцию (по желанию клиента).
- Тестирование поставляемой продукции.
- Поставку компонентов, требующих военную и космическую приемку.
- Входной контроль качества.
- Наличие сертификата ISO.

В составе нашей компании организован Конструкторский отдел, призванный помогать разработчикам, и инженерам.

Конструкторский отдел помогает осуществить:

- Регистрацию проекта у производителя компонентов.
- Техническую поддержку проекта.
- Защиту от снятия компонента с производства.
- Оценку стоимости проекта по компонентам.
- Изготовление тестовой платы монтаж и пусконаладочные работы.



Тел: +7 (812) 336 43 04 (многоканальный)
Email: org@lifeelectronics.ru