

**Full - Bridge
Trench + Field Stop IGBT®
Power Module**

**$V_{CES} = 600V$
 $I_C = 100A^* @ T_c = 80^\circ C$**

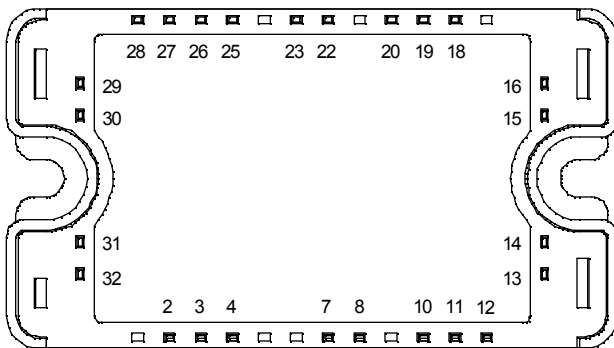
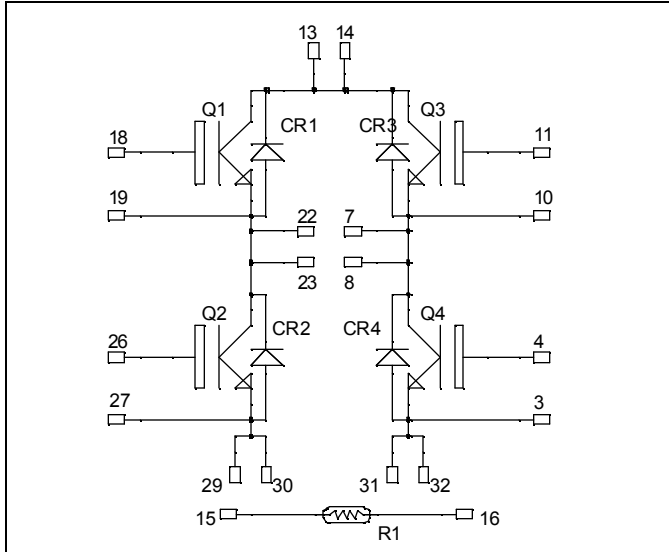

All multiple inputs and outputs must be shorted together
 Example: 13/14 ; 29/30 ; 22/23 ...

Application

- Welding converters
- Switched Mode Power Supplies
- Uninterruptible Power Supplies
- Motor control

Features

- Trench + Field Stop IGBT® Technology
 - Low voltage drop
 - Low tail current
 - Switching frequency up to 20 kHz
 - Soft recovery parallel diodes
 - Low diode VF
 - Low leakage current
 - Avalanche energy rated
 - RBSOA and SCSOA rated
- Kelvin emitter for easy drive
- Very low stray inductance
 - Symmetrical design
- High level of integration
- Internal thermistor for temperature monitoring

Benefits

- Stable temperature behavior
- Very rugged
- Solderable terminals for easy PCB mounting
- Direct mounting to heatsink (isolated package)
- Low junction to case thermal resistance
- Easy paralleling due to positive TC of VCEsat
- Low profile
- Each leg can be easily paralleled to achieve a phase leg of twice the current capability
- RoHS Compliant

Absolute maximum ratings

Symbol	Parameter	Max ratings	Unit
V_{CES}	Collector - Emitter Breakdown Voltage	600	V
I_C	Continuous Collector Current	$T_C = 25^\circ C$	150 *
		$T_C = 80^\circ C$	100 *
I_{CM}	Pulsed Collector Current	$T_C = 25^\circ C$	200
V_{GE}	Gate - Emitter Voltage	± 20	V
P_D	Maximum Power Dissipation	$T_C = 25^\circ C$	340
RBSOA	Reverse Bias Safe Operating Area	$T_j = 150^\circ C$	200A @ 550V

* Specification of IGBT device but output current must be limited to 75A to not exceed a delta of temperature greater than 30°C for the connectors.

CAUTION: These Devices are sensitive to Electrostatic Discharge. Proper Handling Procedures Should Be Followed. See application note APT0502 on www.microsemi.com

All ratings @ $T_j = 25^\circ\text{C}$ unless otherwise specified

Electrical Characteristics

Symbol	Characteristic	Test Conditions	Min	Typ	Max	Unit
I_{CES}	Zero Gate Voltage Collector Current	$V_{GE} = 0\text{V}, V_{CE} = 600\text{V}$			250	μA
$V_{CE(sat)}$	Collector Emitter Saturation Voltage	$V_{GE} = 15\text{V}$ $I_C = 100\text{A}$	$T_j = 25^\circ\text{C}$	1.5	1.9	V
			$T_j = 150^\circ\text{C}$	1.7		
$V_{GE(th)}$	Gate Threshold Voltage	$V_{GE} = V_{CE}, I_C = 1.5\text{ mA}$	5.0	5.8	6.5	V
I_{GES}	Gate – Emitter Leakage Current	$V_{GE} = 20\text{V}, V_{CE} = 0\text{V}$			400	nA

Dynamic Characteristics

Symbol	Characteristic	Test Conditions	Min	Typ	Max	Unit
C_{ies}	Input Capacitance	$V_{GE} = 0\text{V}$		6100		pF
C_{oes}	Output Capacitance	$V_{CE} = 25\text{V}$		390		
C_{res}	Reverse Transfer Capacitance	$f = 1\text{MHz}$		190		
$T_{d(on)}$	Turn-on Delay Time	Inductive Switching (25°C)		115		ns
T_r	Rise Time	$V_{GE} = \pm 15\text{V}$ $V_{Bus} = 300\text{V}$		45		
$T_{d(off)}$	Turn-off Delay Time	$I_C = 100\text{A}$		225		
T_f	Fall Time	$R_G = 3.3\Omega$		55		
$T_{d(on)}$	Turn-on Delay Time	Inductive Switching (150°C)		130		ns
T_r	Rise Time	$V_{GE} = \pm 15\text{V}$ $V_{Bus} = 300\text{V}$		50		
$T_{d(off)}$	Turn-off Delay Time	$I_C = 100\text{A}$		300		
T_f	Fall Time	$R_G = 3.3\Omega$		70		
E_{on}	Turn on Energy	$V_{GE} = \pm 15\text{V}$ $V_{Bus} = 300\text{V}$ $I_C = 100\text{A}$	$T_j = 25^\circ\text{C}$	0.4		mJ
			$T_j = 150^\circ\text{C}$	0.875		
E_{off}	Turn off Energy	$R_G = 3.3\Omega$	$T_j = 25^\circ\text{C}$	2.5		mJ
			$T_j = 150^\circ\text{C}$	3.5		

Reverse diode ratings and characteristics

Symbol	Characteristic	Test Conditions	Min	Typ	Max	Unit
V_{RRM}	Maximum Peak Repetitive Reverse Voltage		600			V
I_{RM}	Maximum Reverse Leakage Current	$V_R = 600\text{V}$	$T_j = 25^\circ\text{C}$		250	μA
			$T_j = 150^\circ\text{C}$		500	
I_F	DC Forward Current			100		A
V_F	Diode Forward Voltage	$I_F = 100\text{A}$ $V_{GE} = 0\text{V}$	$T_j = 25^\circ\text{C}$	1.6	2	V
			$T_j = 150^\circ\text{C}$	1.5		
t_{rr}	Reverse Recovery Time		$T_j = 25^\circ\text{C}$	125		ns
			$T_j = 150^\circ\text{C}$	220		
Q_{rr}	Reverse Recovery Charge	$I_F = 100\text{A}$ $V_R = 300\text{V}$ $di/dt = 2000\text{A}/\mu\text{s}$	$T_j = 25^\circ\text{C}$	4.7		μC
			$T_j = 150^\circ\text{C}$	9.9		
E_r	Reverse Recovery Energy		$T_j = 25^\circ\text{C}$	1.1		mJ
			$T_j = 150^\circ\text{C}$	2.4		

Temperature sensor NTC (see application note APT0406 on www.microsemi.com for more information).

Symbol	Characteristic	Min	Typ	Max	Unit
R ₂₅	Resistance @ 25°C		50		kΩ
B _{25/85}	T ₂₅ = 298.15 K		3952		K

$$R_T = \frac{R_{25}}{\exp\left[B_{25/85}\left(\frac{1}{T_{25}} - \frac{1}{T}\right)\right]}$$

T: Thermistor temperature
 R_T: Thermistor value at T

Thermal and package characteristics

Symbol	Characteristic	Min	Typ	Max	Unit
R _{thJC}	Junction to Case Thermal Resistance	IGBT		0.44	°C/W
		Diode		0.77	
V _{ISOL}	RMS Isolation Voltage, any terminal to case t=1 min, I _{isol} <1mA, 50/60Hz	2500			V
T _J	Operating junction temperature range	-40		175	°C
T _{STG}	Storage Temperature Range	-40		125	
T _C	Operating Case Temperature	-40		100	
Torque	Mounting torque				
	To heatsink	M4	2.5	4.7	N.m
Wt	Package Weight			110	g

SP3 Package outline (dimensions in mm)

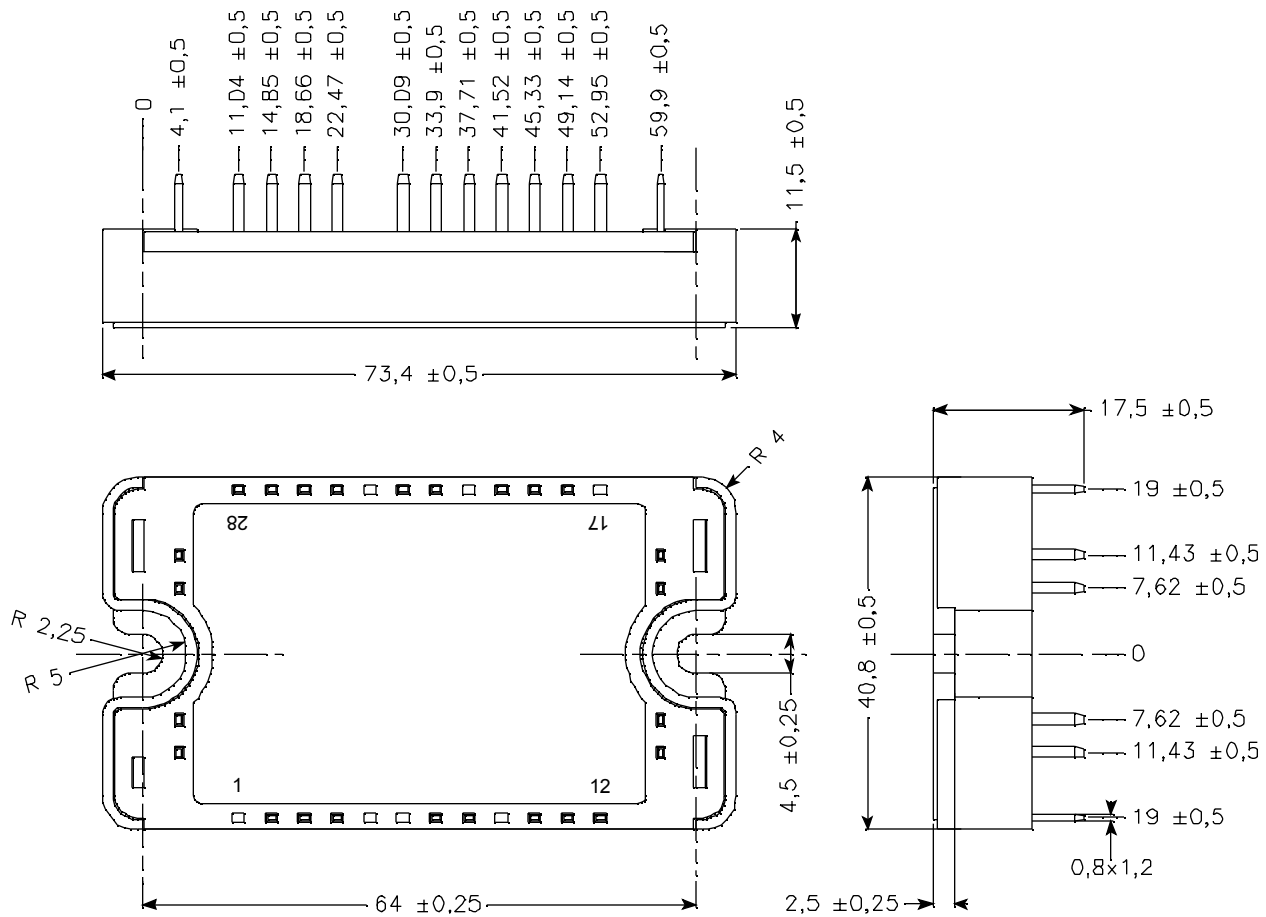

See application note 1901 - Mounting Instructions for SP3 Power Modules on www.microsemi.com

Typical Performance Curve

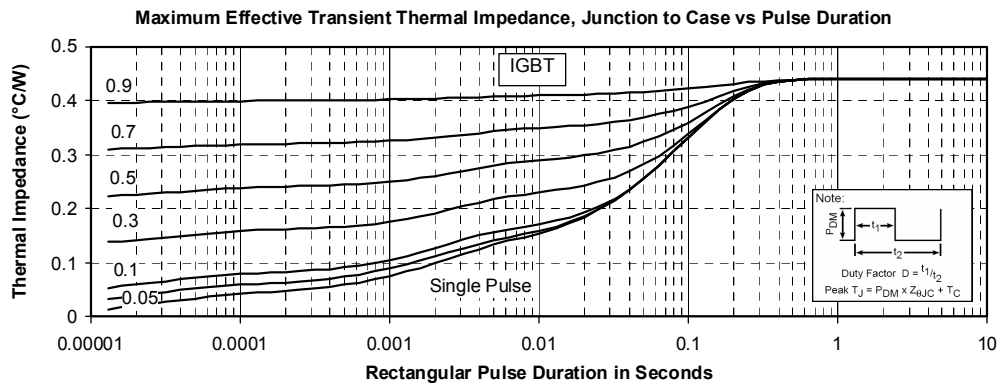
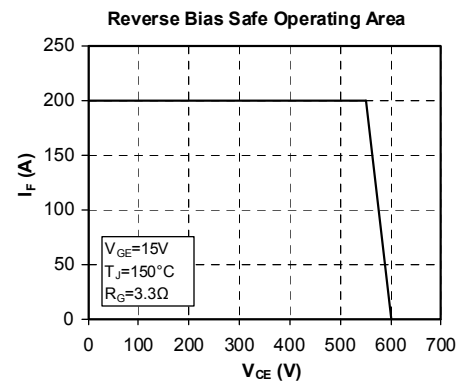
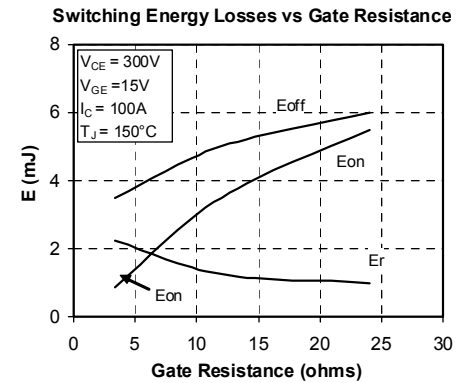
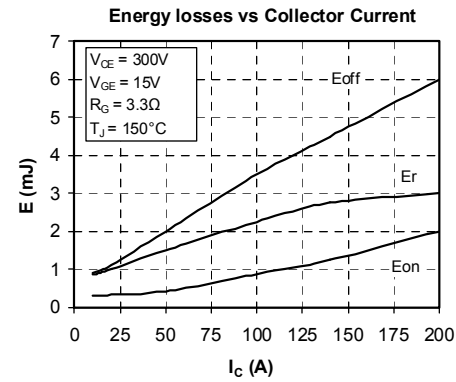
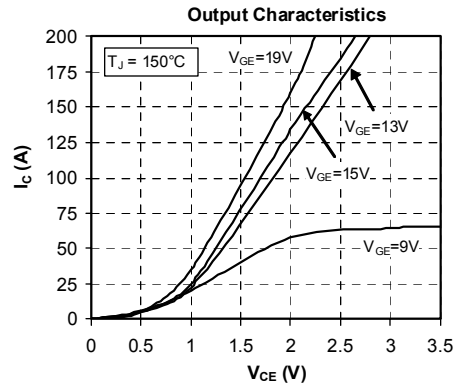
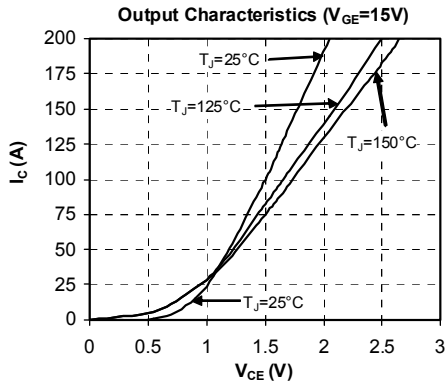

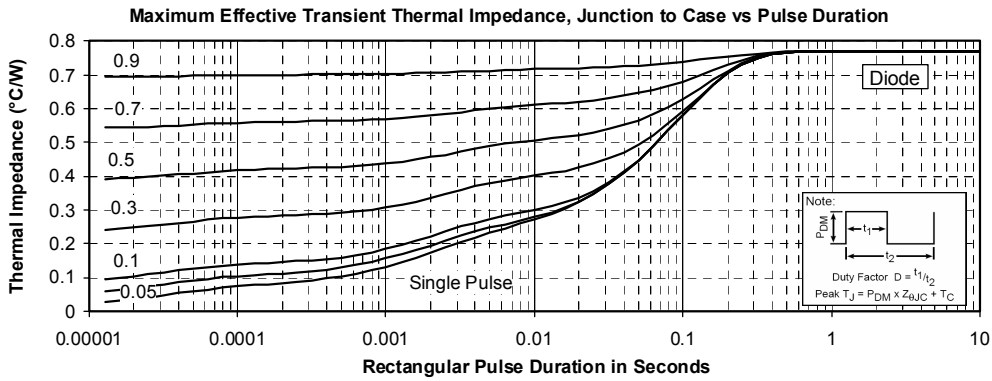
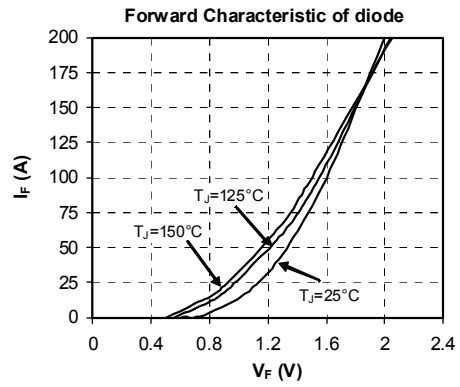

Microsemi reserves the right to change, without notice, the specifications and information contained herein

Microsemi's products are covered by one or more of U.S. patents 4,895,810 5,045,903 5,089,434 5,182,234 5,019,522 5,262,336 6,503,786 5,256,583 4,748,103 5,283,202 5,231,474 5,434,095 5,528,058 and foreign patents. U.S. and Foreign patents pending. All Rights Reserved.

Компания «Life Electronics» занимается поставками электронных компонентов импортного и отечественного производства от производителей и со складов крупных дистрибьюторов Европы, Америки и Азии.

С конца 2013 года компания активно расширяет линейку поставок компонентов по направлению коаксиальный кабель, кварцевые генераторы и конденсаторы (керамические, пленочные, электролитические), за счёт заключения дистрибьюторских договоров

Мы предлагаем:

- Конкурентоспособные цены и скидки постоянным клиентам.
- Специальные условия для постоянных клиентов.
- Подбор аналогов.
- Поставку компонентов в любых объемах, удовлетворяющих вашим потребностям.
- Приемлемые сроки поставки, возможна ускоренная поставка.
- Доставку товара в любую точку России и стран СНГ.
- Комплексную поставку.
- Работу по проектам и поставку образцов.
- Формирование склада под заказчика.
- Сертификаты соответствия на поставляемую продукцию (по желанию клиента).
- Тестирование поставляемой продукции.
- Поставку компонентов, требующих военную и космическую приемку.
- Входной контроль качества.
- Наличие сертификата ISO.

В составе нашей компании организован Конструкторский отдел, призванный помогать разработчикам, и инженерам.

Конструкторский отдел помогает осуществить:

- Регистрацию проекта у производителя компонентов.
- Техническую поддержку проекта.
- Защиту от снятия компонента с производства.
- Оценку стоимости проекта по компонентам.
- Изготовление тестовой платы монтаж и пусконаладочные работы.



Тел: +7 (812) 336 43 04 (многоканальный)

Email: org@lifeelectronics.ru