

THIS DRAWING IS UNPUBLISHED. RELEASED FOR PUBLICATION 20
 © COPYRIGHT 20 BY - ALL RIGHTS RESERVED.

REVISIONS				
P	LTR	DESCRIPTION	DATE	APVD
	E12	REVISED PER ECO-13-016361	19OCT2013	KH MM

1 MATERIALS AND FINISH
 HOUSING: PA 6-6, UL 94-V0, COLOR: GREEN.
 CLAMP: BRASS, NICKEL PLATED.
 CONTACT SPRING : PHOSPHOR BRONZE, TIN PLATED.
 CLAMPING SCREW: M3, BRASS, NICKEL PLATED.

2. WIRE SIZE RANGE: 12 - 30 AWG

3 NOT CUMULATIVE TOLERANCE.

4 CHARACTERS MARKED IN PERMANENT WHITE COLOR.

5 PARTS SHOWN WITH INTEGRATED KEYING FEATURE LOCATED AS SHOWN.

6 CHARACTERS MARKED IN PERMANENT BLACK COLOR.

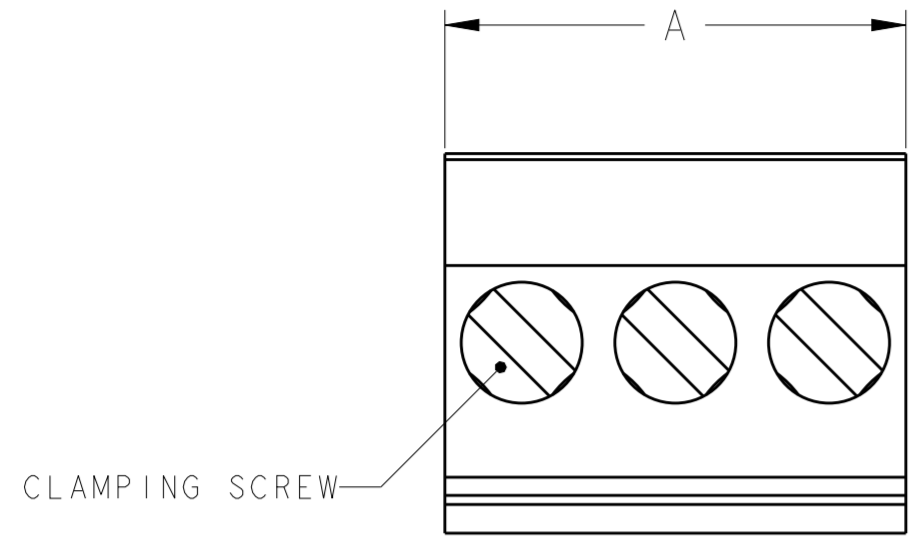

CLAMPING SCREW

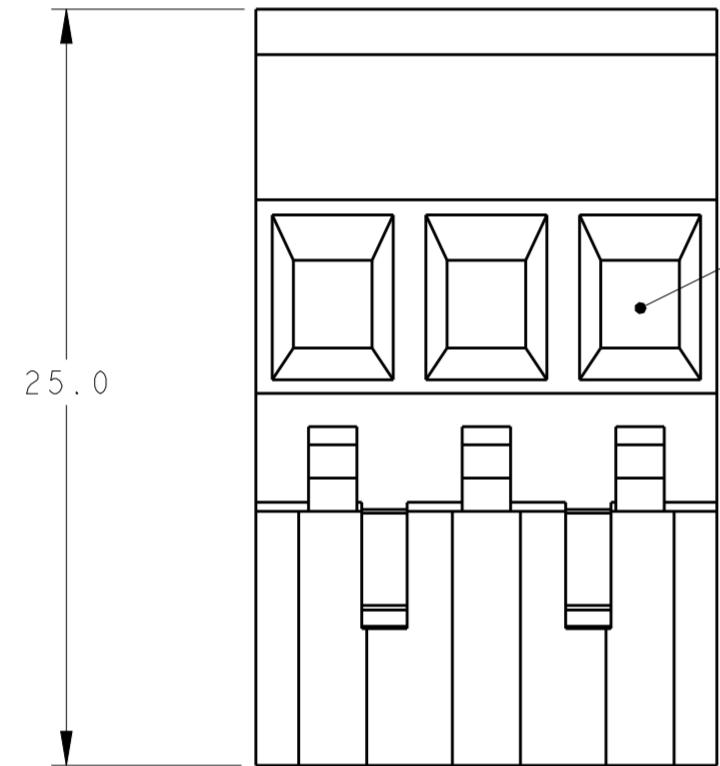

WIRE ENTRY

RETENTION LATCH

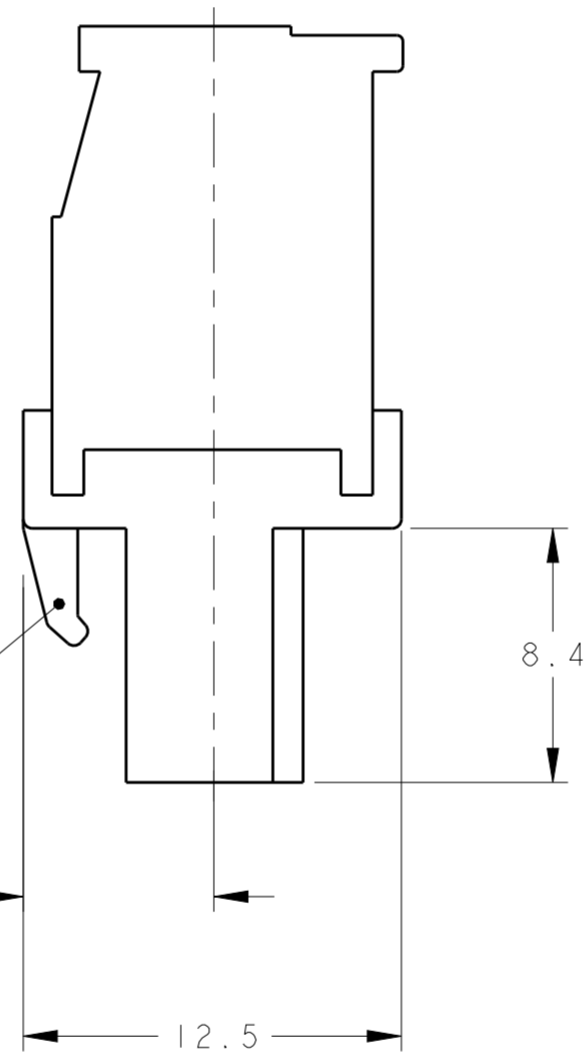

POLARIZATION KEY SLOT

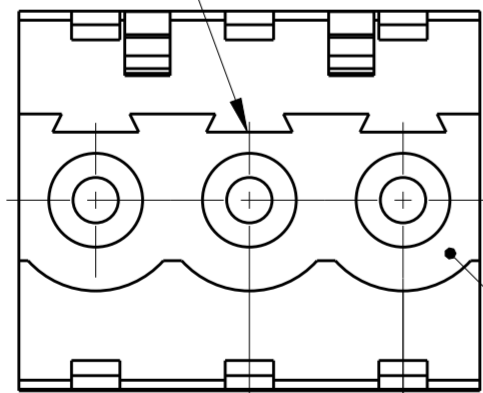

MATING FACE

2.54 REF TYP

3
 5.08 ± 0.05
 TYP

SEE DETAIL A-D	106.68	21	4-284047-1
SEE DETAIL A-C	106.68	21	4-284047-0
SEE DETAIL A-B	76.20	15	3-284047-9
SEE DETAIL A-A	76.20	15	3-284047-8
SEE DETAIL Z	121.92	24	3-284047-7
5 SEE DETAIL X	81.28	16	3-284047-6
5 SEE DETAIL W	81.28	16	3-284047-5
5 SEE DETAIL V	60.96	12	3-284047-4
5 SEE DETAIL U	60.96	12	3-284047-3
5 SEE DETAIL T	121.92	24	3-284047-2
5 SEE DETAIL S	121.92	24	3-284047-1
5 SEE DETAIL R	91.44	18	3-284047-0
5 SEE DETAIL P	91.44	18	2-284047-9
SEE DETAIL N	24.40	5	2-284047-8
SEE DETAIL M	20.32	4	2-284047-7
SEE DETAIL L	10.16	2	2-284047-6
-	127.00	25	2-284047-5
-	121.92	24	2-284047-4
-	116.84	23	2-284047-3
-	111.76	22	2-284047-2
-	106.68	21	2-284047-1
-	101.60	20	2-284047-0
-	96.52	19	1-284047-9
-	91.44	18	1-284047-8
-	86.36	17	1-284047-7
-	81.28	16	1-284047-6
-	76.20	15	1-284047-5
-	71.12	14	1-284047-4
-	66.04	13	1-284047-3
-	60.96	12	1-284047-2
-	55.88	11	1-284047-1
-	50.80	10	1-284047-0
-	45.72	9	284047-9
-	40.64	8	284047-8
-	35.56	7	284047-7
-	30.48	6	284047-6
-	25.40	5	284047-5
-	20.32	4	284047-4
-	15.24	3	284047-3
-	10.16	2	284047-2

MARKING A NO OF POSN PART NUMBER

THIS DRAWING IS A CONTROLLED DOCUMENT.		DWN S. WELDON 05FEB2003
DIMENSIONS: mm		CHK C. RICHARD 05FEB2003
TOLERANCES UNLESS OTHERWISE SPECIFIED:		APVD C. RICHARD 05FEB2003
0 PLC ±-	±3	PRODUCT SPEC
1 PLC ±.3	±.25	APPLICATION SPEC
2 PLC ±-	±-	WEIGHT
3 PLC ±-	±-	CUSTOMER DRAWING
4 PLC ±-	±2	SCALE 1:1
ANGLES		SHEET 1 OF 8
FINISH		REV E12

STE TE Connectivity

NAME: TERMINAL BLOCK, VERTICAL PLUG, STACKING, RIGHT HAND, 5.08mm PITCH

SIZE: A2 CAGE CODE: 0779 DRAWING NO: C-284047

THIS DRAWING IS UNPUBLISHED. RELEASED FOR PUBLICATION 20
 © COPYRIGHT 20 BY - ALL RIGHTS RESERVED.

REVISIONS				
P	LTR	DESCRIPTION	DATE	APVD
-		SEE SHEET 1	-	-

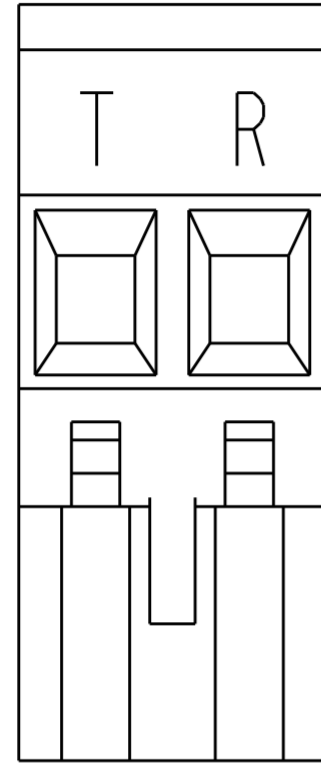

SEE DETAIL L

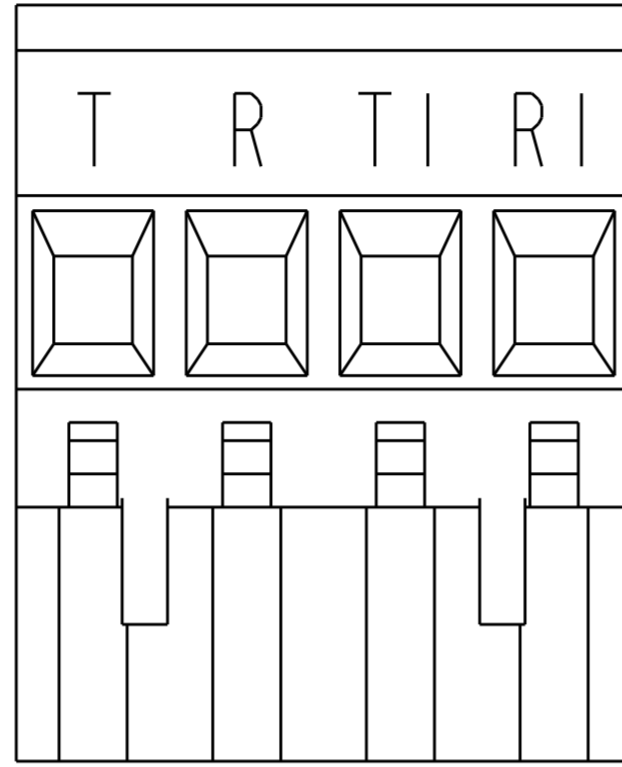

SEE DETAIL M

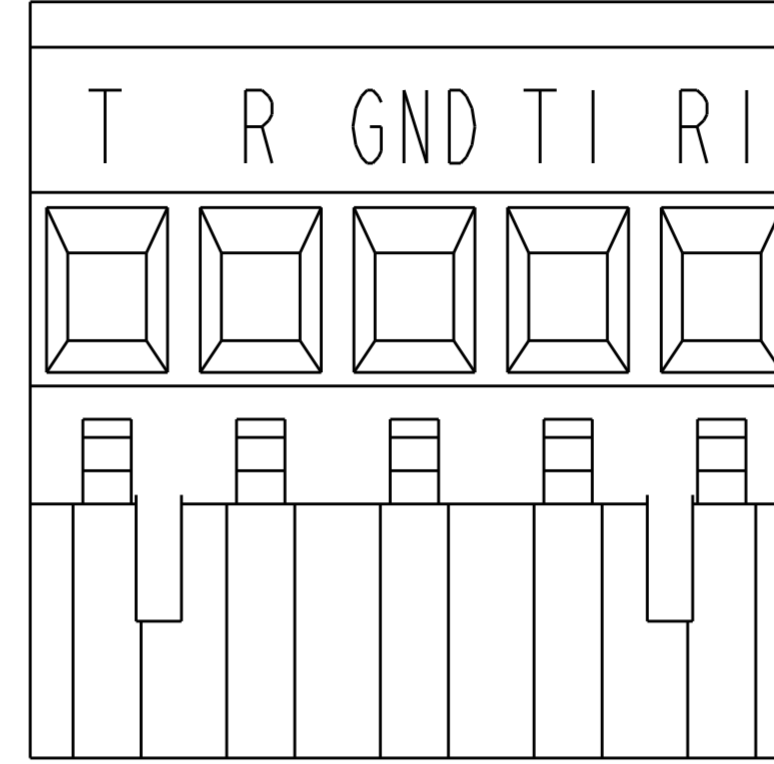

SEE DETAIL N

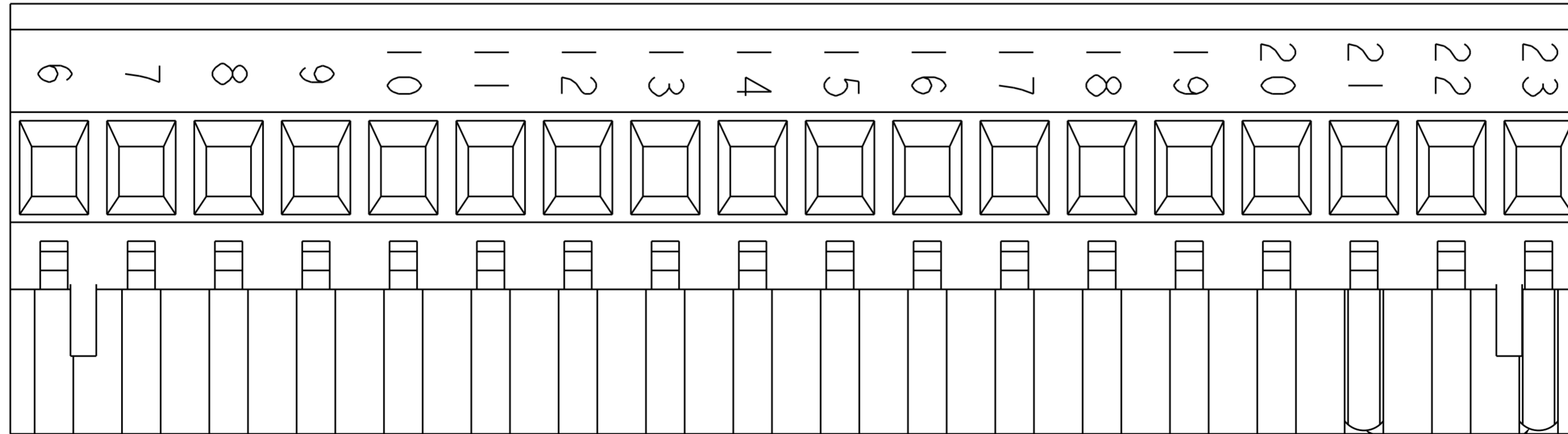

SEE DETAIL P



CODING KEY

THIS DRAWING IS A CONTROLLED DOCUMENT.		DWN S. WELDON 05FEB2003	 TE Connectivity
DIMENSIONS: mm		CHK C. RICHARD 05FEB2003	
TOLERANCES UNLESS OTHERWISE SPECIFIED:		APVD C. RICHARD 05FEB2003	
0 PLC ±- 1 PLC ±.3 2 PLC ±.25 3 PLC ±- 4 PLC ±- ANGLES ±2 FINISH -		PRODUCT SPEC - APPLICATION SPEC - WEIGHT -	
MATERIAL -		NAME TERMINAL BLOCK, VERTICAL PLUG, STACKING, RIGHT HAND, 5.08mm PITCH SIZE A20779 CAGE CODE C-284047 DRAWING NO. RESTRICTED TO - SCALE 1:1 SHEET 2 OF 8 REV E12	
		CUSTOMER DRAWING	

THIS DRAWING IS UNPUBLISHED. RELEASED FOR PUBLICATION 20
 © COPYRIGHT 20 BY - ALL RIGHTS RESERVED.

REVISIONS				
P	LTR	DESCRIPTION	DATE	APVD
-	-	SEE SHEET 1	-	-

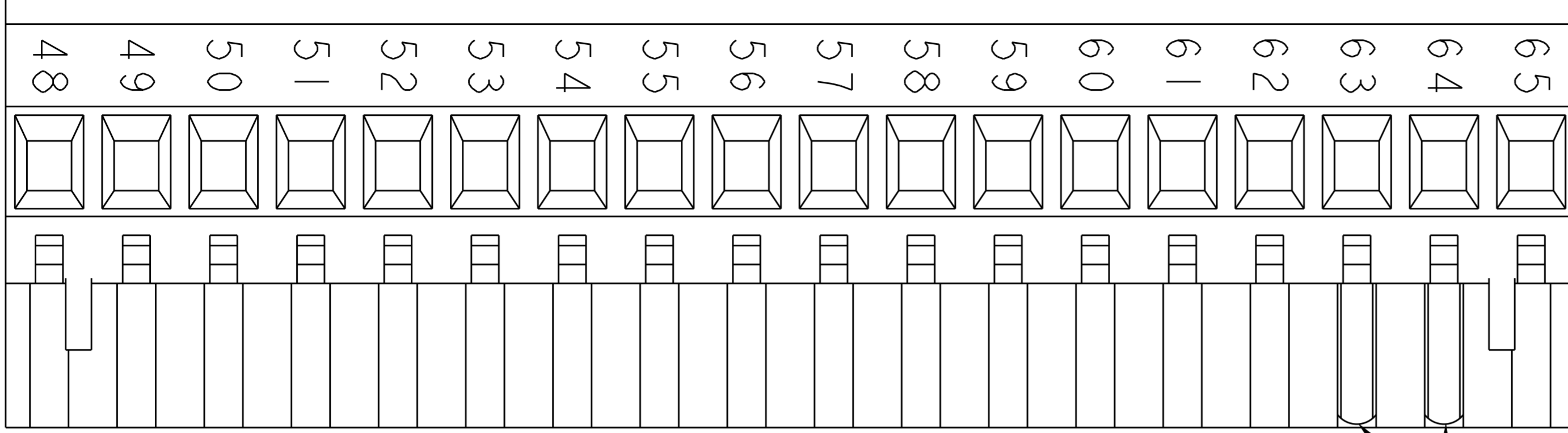

SEE DETAIL R

CODING KEY

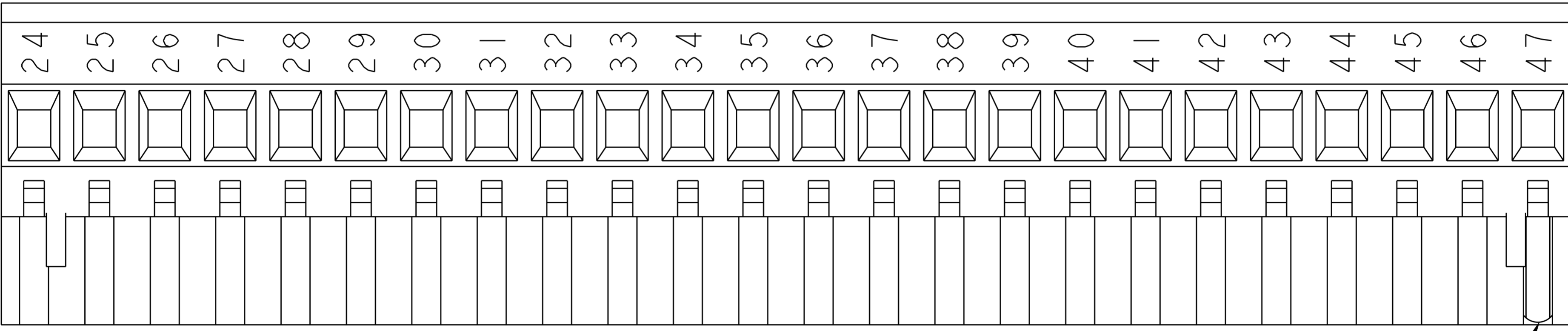

SEE DETAIL S

CODING KEY

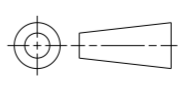
THIS DRAWING IS A CONTROLLED DOCUMENT.		DWN S. WELDON 05FEB2003	 TE Connectivity
DIMENSIONS: mm		CHK C. RICHARD 05FEB2003	
		APVD C. RICHARD 05FEB2003	
TOLERANCES UNLESS OTHERWISE SPECIFIED:		PRODUCT SPEC	
0 PLC ±3		APPLICATION SPEC	NAME TERMINAL BLOCK, VERTICAL PLUG, STACKING, RIGHT HAND, 5.08mm PITCH
1 PLC ±.3		WEIGHT	SIZE A2
2 PLC ±.25		CUSTOMER DRAWING	CAGE CODE C-284047
3 PLC ±.		SCALE 1:1	DRAWING NO. 3 OF 8
4 PLC ±.		SHEET	RESTRICTED TO
ANGLES ±2		REV E12	
FINISH			

THIS DRAWING IS UNPUBLISHED. RELEASED FOR PUBLICATION 20
 © COPYRIGHT 20 BY - ALL RIGHTS RESERVED.

REVISIONS				
P	LTR	DESCRIPTION	DATE	APVD
-		SEE SHEET 1	-	-

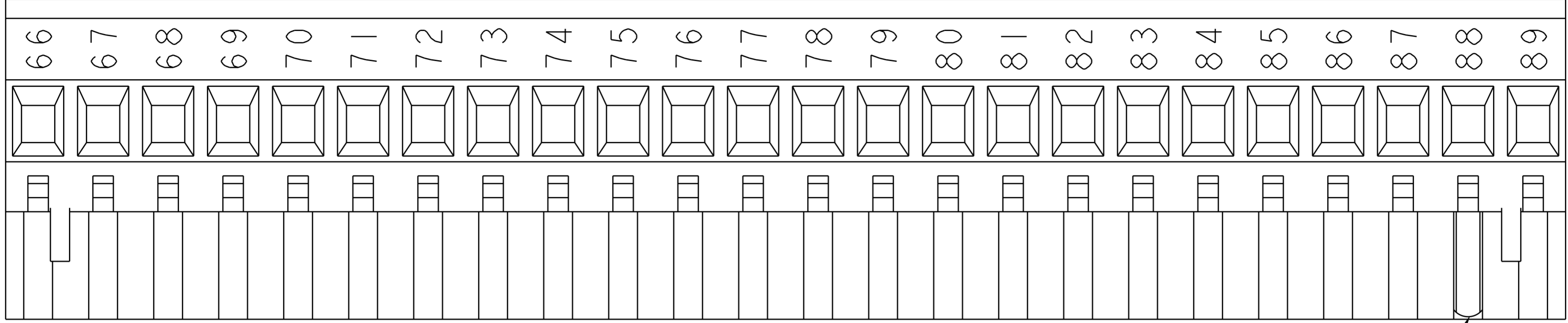

SEE DETAIL T

CODING KEY →

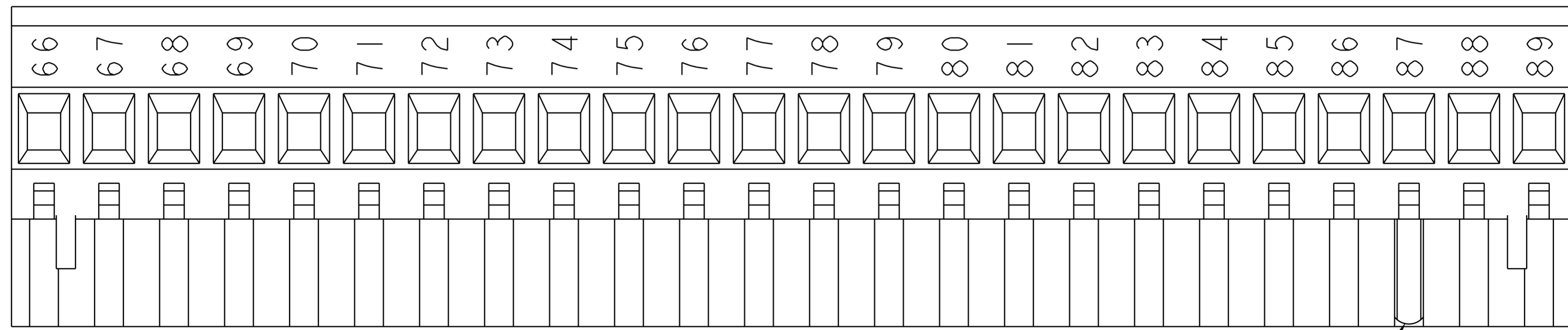

SEE DETAIL Z

CODING KEY →

THIS DRAWING IS A CONTROLLED DOCUMENT.		DWN S. WELDON 05FEB2003	TE Connectivity	
		CHK C. RICHARD 05FEB2003		
		APVD C. RICHARD 05FEB2003	NAME	
DIMENSIONS: mm 		PRODUCT SPEC	TERMINAL BLOCK, VERTICAL PLUG, STACKING, RIGHT HAND, 5.08mm PITCH	
TOLERANCES UNLESS OTHERWISE SPECIFIED: 0 PLC ±- 1 PLC ±.3 2 PLC ±.25 3 PLC ±- 4 PLC ±- ANGLES ±2 FINISH -		APPLICATION SPEC	SIZE	RESTRICTED TO
MATERIAL -		WEIGHT -	A20779	
		CUSTOMER DRAWING	CAGE CODE C-284047	DRAWING NO
			SCALE 1:1	SHEET 4 OF 8
				REV E12

THIS DRAWING IS UNPUBLISHED. RELEASED FOR PUBLICATION 20
 © COPYRIGHT 20 BY - ALL RIGHTS RESERVED.

REVISIONS				
P	LTR	DESCRIPTION	DATE	APVD
-		SEE SHEET 1	-	-

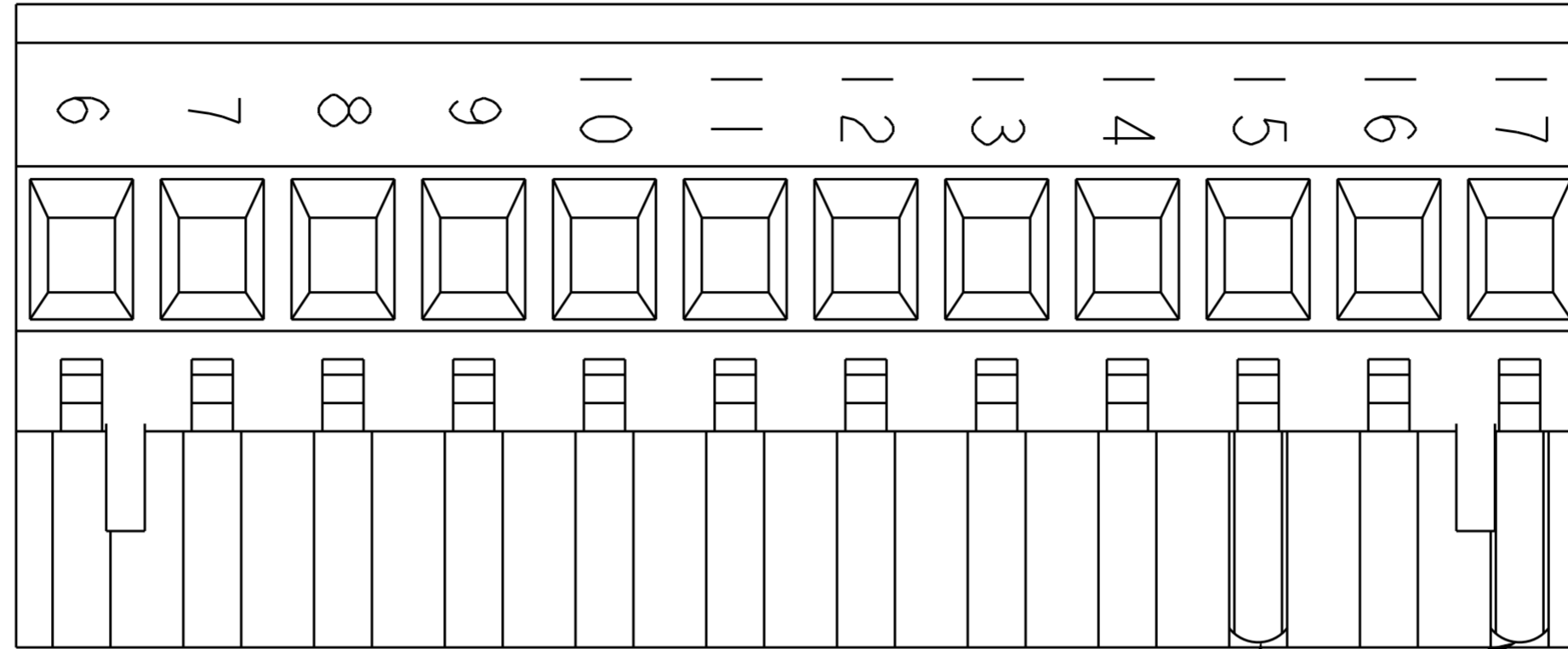

SEE DETAIL U



CODING KEY

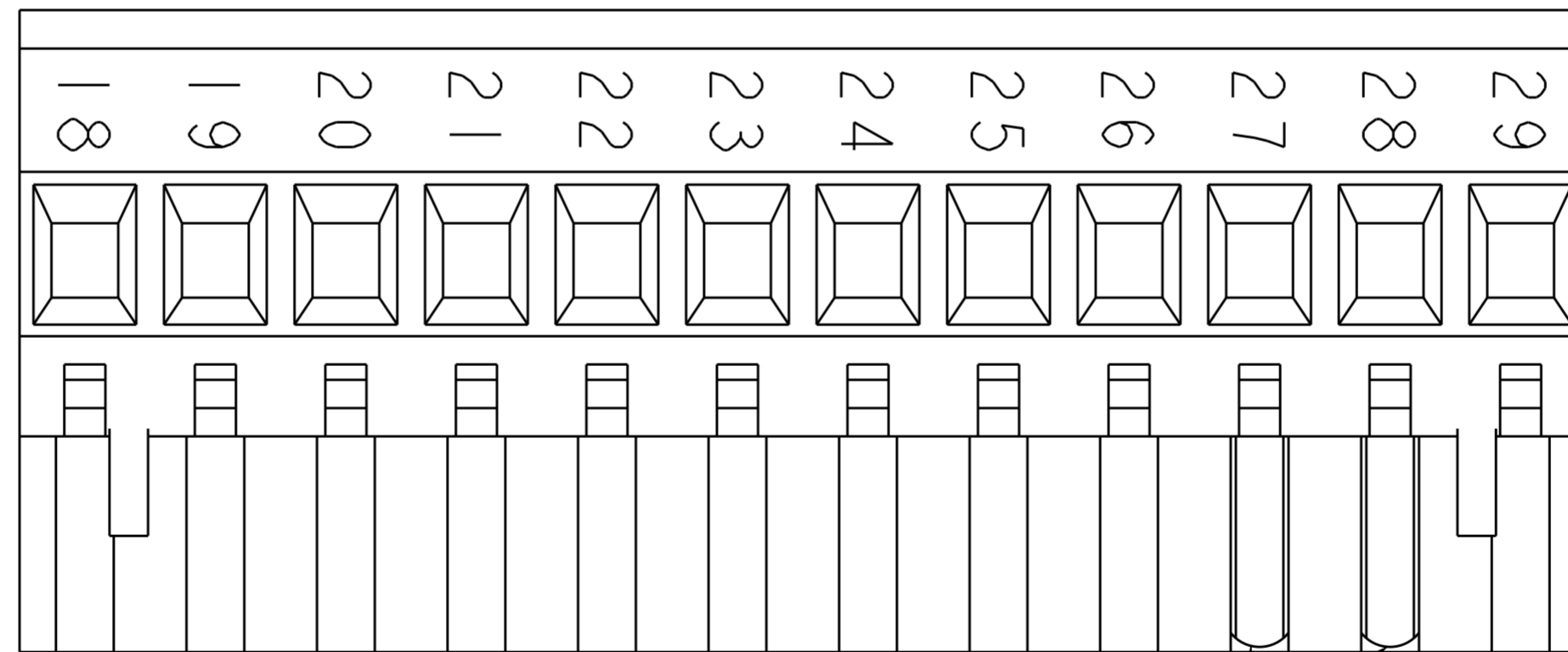

SEE DETAIL V

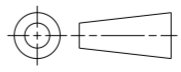

CODING KEY

THIS DRAWING IS A CONTROLLED DOCUMENT.		DWN S. WELDON 05FEB2003	 TE Connectivity
		CHK C. RICHARD 05FEB2003	
		APVD C. RICHARD 05FEB2003	
		PRODUCT SPEC	
DIMENSIONS: mm 		APPLICATION SPEC	NAME TERMINAL BLOCK, VERTICAL PLUG, STACKING, RIGHT HAND, 5.08mm PITCH
TOLERANCES UNLESS OTHERWISE SPECIFIED: 0 PLC ±- 1 PLC ±.3 2 PLC ±.25 3 PLC ±- 4 PLC ±- ANGLES ±2 FINISH -		WEIGHT -	SIZE A2 CAGE CODE 0779 DRAWING NO. C-284047 RESTRICTED TO -
MATERIAL -		CUSTOMER DRAWING	SCALE 1:1 SHEET 5 OF 8 REV E12

THIS DRAWING IS UNPUBLISHED. RELEASED FOR PUBLICATION 20
 © COPYRIGHT 20 BY - ALL RIGHTS RESERVED.

REVISIONS				
P	LTR	DESCRIPTION	DATE	APVD
-	-	SEE SHEET 1	-	-

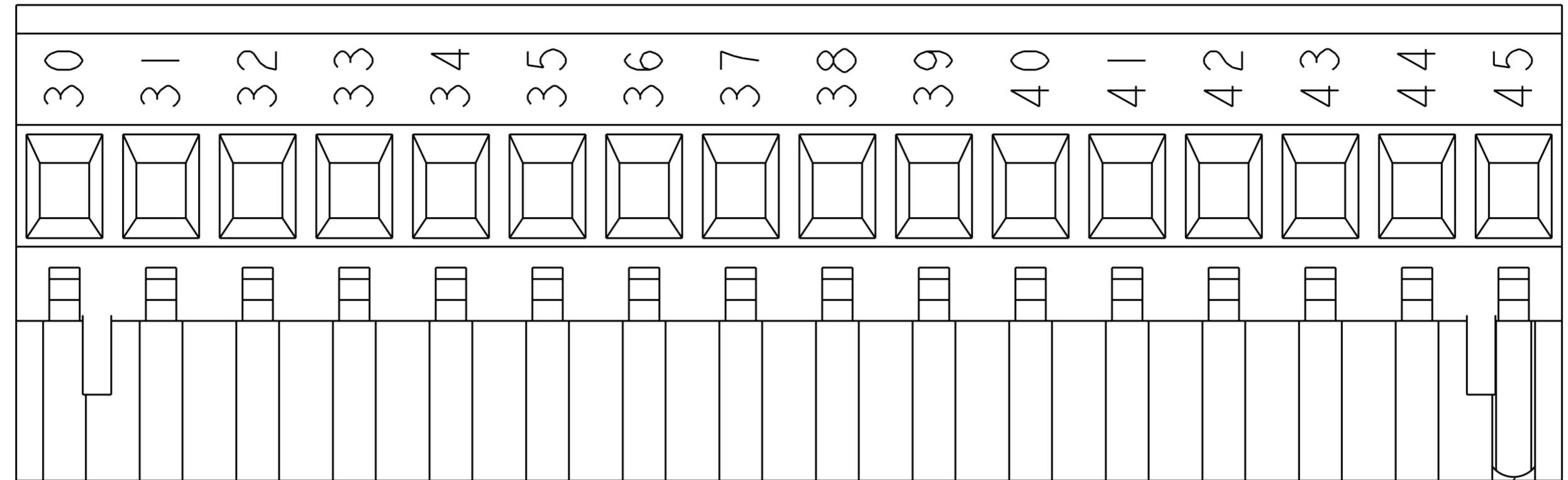

SEE DETAIL W



CODING KEY

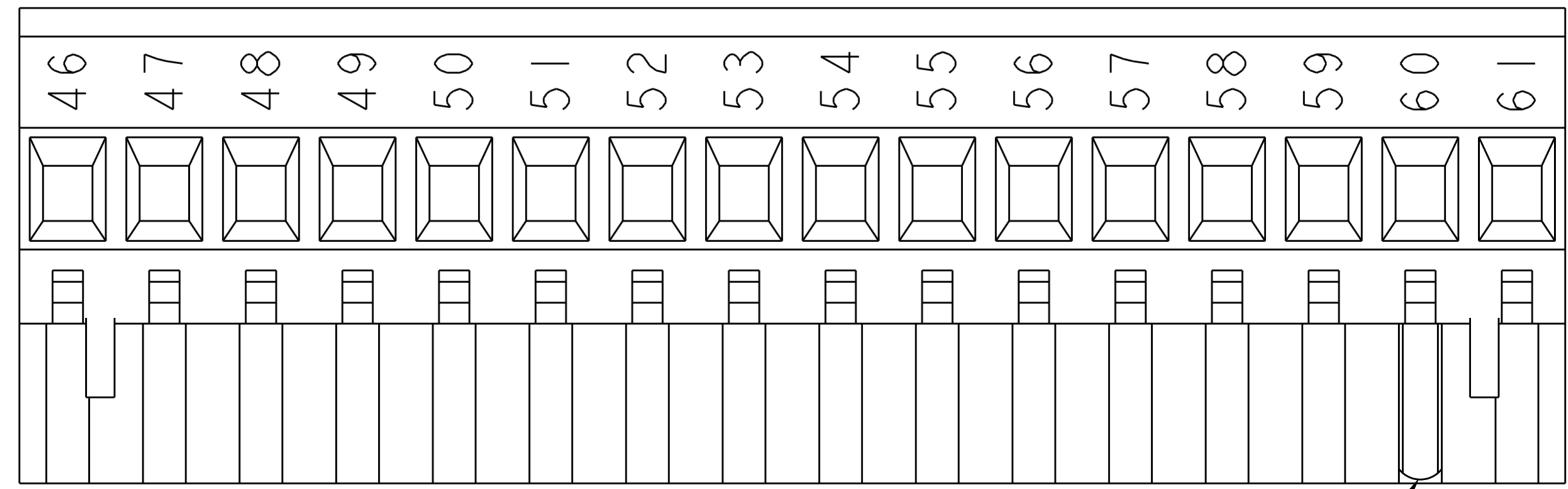

SEE DETAIL X



CODING KEY

THIS DRAWING IS A CONTROLLED DOCUMENT.		DWN S. WELDON 05FEB2003	TE Connectivity	
DIMENSIONS: mm		CHK C. RICHARD 05FEB2003		
TOLERANCES UNLESS OTHERWISE SPECIFIED:		APVD C. RICHARD 05FEB2003	NAME TERMINAL BLOCK, VERTICAL PLUG, STACKING, RIGHT HAND, 5.08mm PITCH	
0 PLC ±- 1 PLC ±.3 2 PLC ±.25 3 PLC ±- 4 PLC ±- ANGLES ±2 FINISH		PRODUCT SPEC -	SIZE A2	CAGE CODE 0779
MATERIAL -		APPLICATION SPEC -	DRAWING NO C-284047	RESTRICTED TO -
-		WEIGHT -	SCALE 1:1 SHEET 6 OF 8 REV E12	
-		CUSTOMER DRAWING		

THIS DRAWING IS UNPUBLISHED. RELEASED FOR PUBLICATION 20
 © COPYRIGHT 20 BY - ALL RIGHTS RESERVED.

REVISIONS				
P	LTR	DESCRIPTION	DATE	APVD
-		SEE SHEET 1	-	-

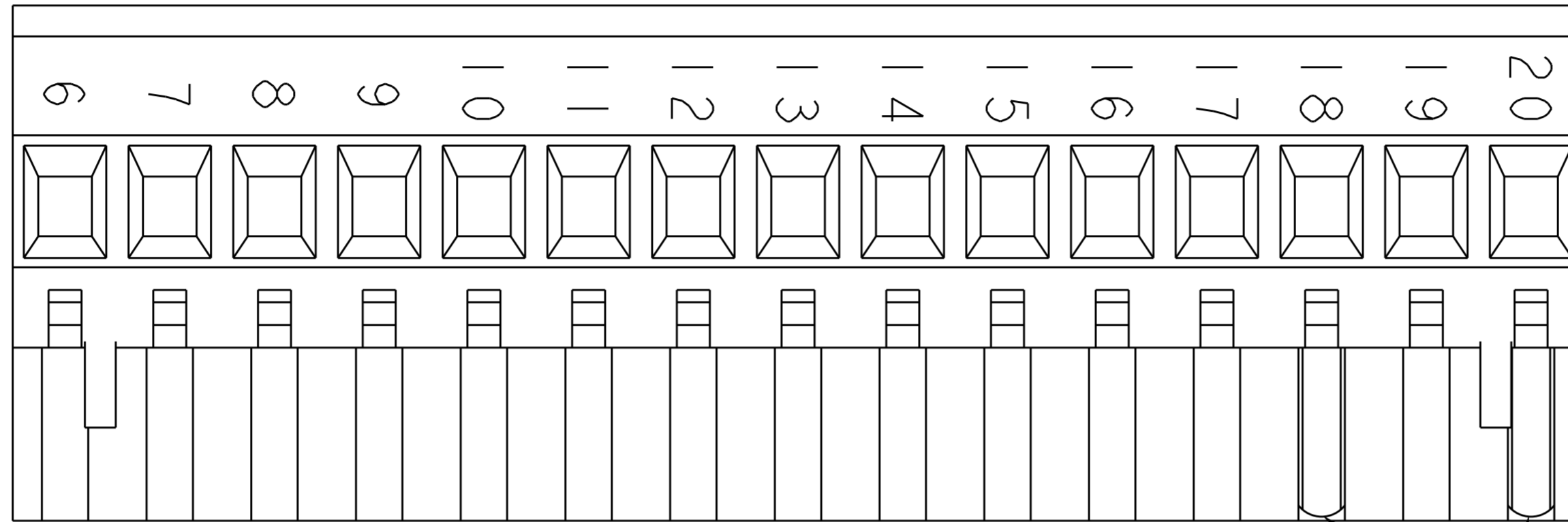

SEE DETAIL A-A



CODING KEY

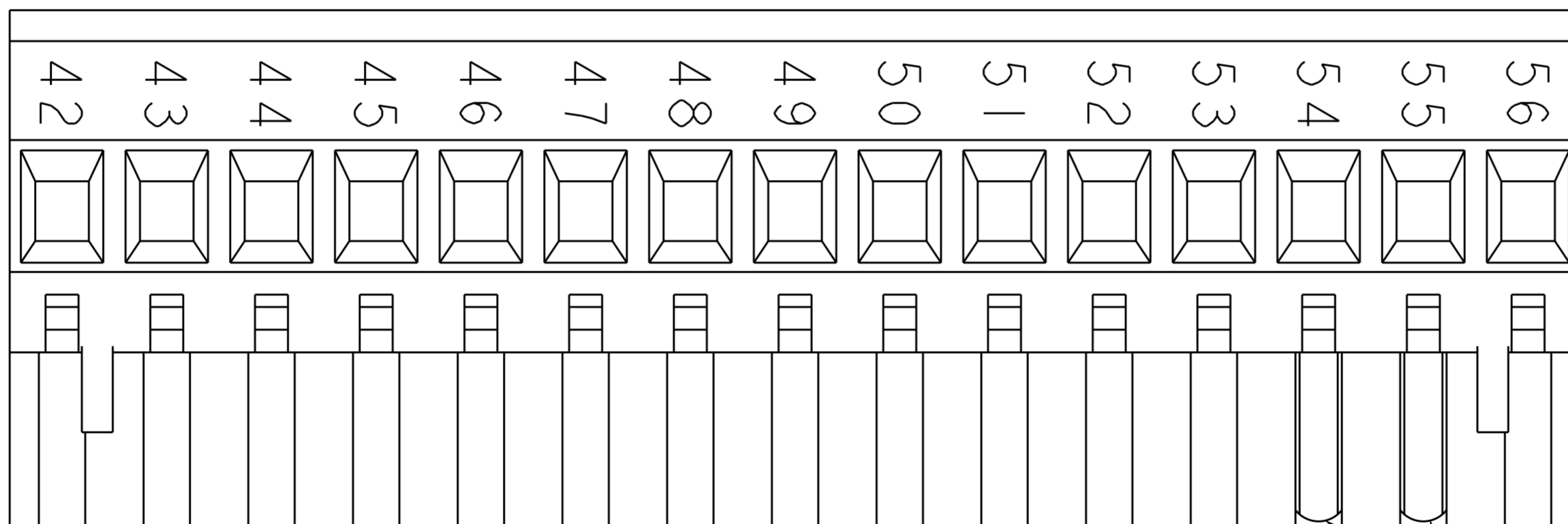

SEE DETAIL A-B



CODING KEY

THIS DRAWING IS A CONTROLLED DOCUMENT.		DWN S. WELDON 05FEB2003	TE Connectivity	
DIMENSIONS: mm		CHK C. RICHARD 05FEB2003		
TOLERANCES UNLESS OTHERWISE SPECIFIED:		APVD C. RICHARD 05FEB2003	NAME TERMINAL BLOCK, VERTICAL PLUG, STACKING, RIGHT HAND, 5.08mm PITCH	
0 PLC ±- 1 PLC ±.3 2 PLC ±.25 3 PLC ±- 4 PLC ±- ANGLES ±2 FINISH		PRODUCT SPEC -	SIZE A20779	DRAWING NO C-284047
MATERIAL -		APPLICATION SPEC -	RESTRICTED TO -	
		WEIGHT -	SCALE 1:1	SHEET 7 OF 8
		CUSTOMER DRAWING	REV E12	

THIS DRAWING IS UNPUBLISHED. RELEASED FOR PUBLICATION 20
 © COPYRIGHT 20 BY - ALL RIGHTS RESERVED.

REVISIONS				
P	LTR	DESCRIPTION	DATE	APVD
-		SEE SHEET 1	-	-

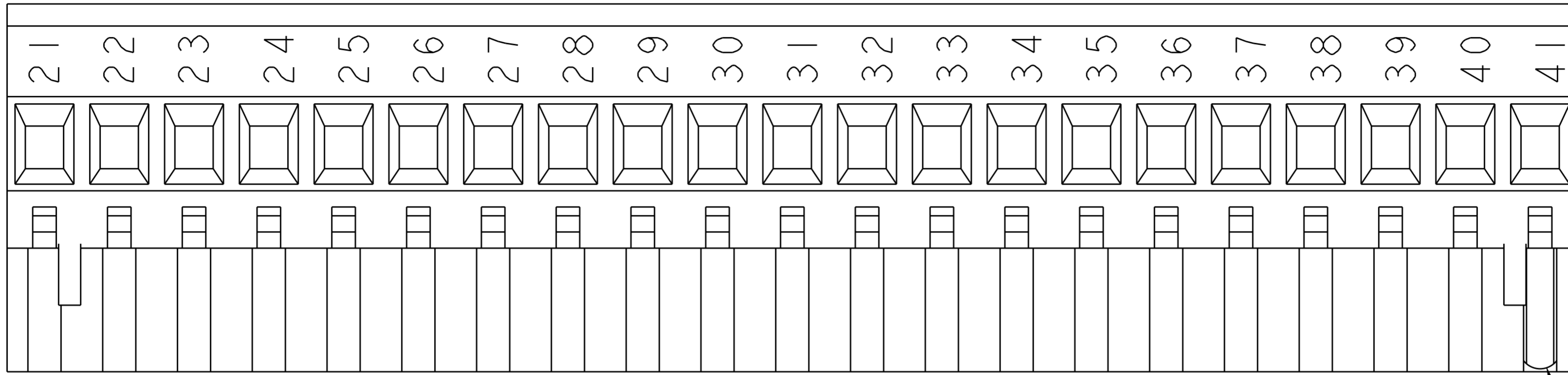

SEE DETAIL A-C

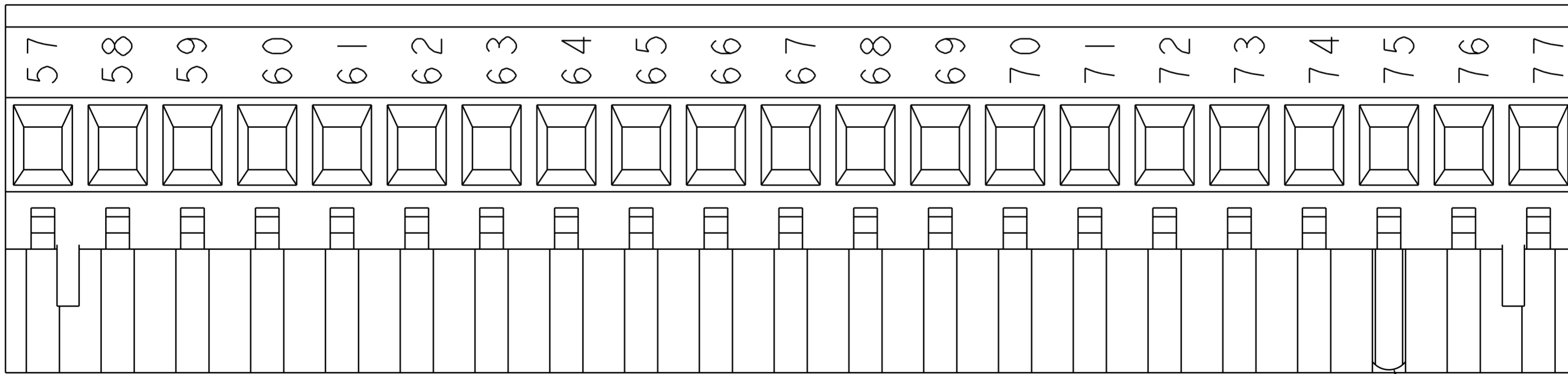

SEE DETAIL A-D

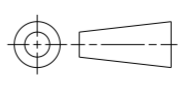

THIS DRAWING IS A CONTROLLED DOCUMENT.		DWN S. WELDON 05FEB2003	 TE Connectivity
		CHK C. RICHARD 05FEB2003	
		APVD C. RICHARD 05FEB2003	
		PRODUCT SPEC	
DIMENSIONS: mm 		APPLICATION SPEC	NAME TERMINAL BLOCK, VERTICAL PLUG, STACKING, RIGHT HAND, 5.08mm PITCH
TOLERANCES UNLESS OTHERWISE SPECIFIED: 0 PLC ±- 1 PLC ±.3 2 PLC ±.25 3 PLC ±- 4 PLC ±- ANGLES ±2 FINISH -		WEIGHT -	SIZE A2 CAGE CODE 0779 DRAWING NO. C-284047 RESTRICTED TO -
MATERIAL -		CUSTOMER DRAWING	SCALE 1:1 SHEET 8 OF 8 REV E12

Компания «Life Electronics» занимается поставками электронных компонентов импортного и отечественного производства от производителей и со складов крупных дистрибьюторов Европы, Америки и Азии.

С конца 2013 года компания активно расширяет линейку поставок компонентов по направлению коаксиальный кабель, кварцевые генераторы и конденсаторы (керамические, пленочные, электролитические), за счёт заключения дистрибьюторских договоров

Мы предлагаем:

- Конкурентоспособные цены и скидки постоянным клиентам.
- Специальные условия для постоянных клиентов.
- Подбор аналогов.
- Поставку компонентов в любых объемах, удовлетворяющих вашим потребностям.
- Приемлемые сроки поставки, возможна ускоренная поставка.
- Доставку товара в любую точку России и стран СНГ.
- Комплексную поставку.
- Работу по проектам и поставку образцов.
- Формирование склада под заказчика.
- Сертификаты соответствия на поставляемую продукцию (по желанию клиента).
- Тестирование поставляемой продукции.
- Поставку компонентов, требующих военную и космическую приемку.
- Входной контроль качества.
- Наличие сертификата ISO.

В составе нашей компании организован Конструкторский отдел, призванный помогать разработчикам, и инженерам.

Конструкторский отдел помогает осуществить:

- Регистрацию проекта у производителя компонентов.
- Техническую поддержку проекта.
- Защиту от снятия компонента с производства.
- Оценку стоимости проекта по компонентам.
- Изготовление тестовой платы монтаж и пусконаладочные работы.



Тел: +7 (812) 336 43 04 (многоканальный)

Email: org@lifeelectronics.ru