



Chip varistors

Voltage Protection Devices

Automotive grade

AVR series

AVRM, AVR-M series

AVRM1608/AVR-M1608	JIS 1608 [EIA 0603]
AVRM2012/AVR-M2012	JIS 2012 [EIA 0805]

AVRL series

AVRL10	JIS 1005 [EIA 0402]
AVRL16	JIS 1608 [EIA 0603]

AVRH series

AVRH10	JIS 1005 [EIA 0402]
--------	---------------------

Chip varistors

Automotive grade

Product compatible with RoHS directive
 Compatible with lead-free solders
 AEC-Q200

Overview of the AVR series

CHARACTERISTICS OF CHIP VARISTOR

Varistors are voltage dependent nonlinear resistive elements with a resistance that decreases rapidly when the voltage is over the constant value.
 Varistors become zener diode of 2 serial connection and equivalent, and does not have polarity.

CURRENT vs. VOLTAGE CHARACTERISTICS



THE EFFECT OF THE VARISTOR

Without varistor

A malfunction and failure of electronic equipment



With Varistor

Suppress transient voltage by inserting varistor in a circuit



EQUIVALENT CIRCUIT OF CHIP VARISTORS

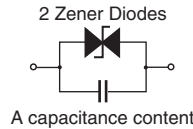

CHIP VARISTORS FEATURE FOR AUTOMOTIVE GRADE

- Reliability characteristics evaluated based on AEC-Q200 condition.
- High ESD withstanding voltage
- Small-sized products are available
- 125°C, 150°C Supported

Figure 1 internal structure of multilayer chip varistors



No.	Name	
(1)	Semiconductor ceramic	
(2)	Internal electrode(Pd)	
(3)	Terminal electrode	Ag
(4)	Terminal electrode	Ni
(5)	Terminal electrode	Sn

Chip varistors

Automotive grade

Product compatible with RoHS directive
Compatible with lead-free solders
AEC-Q200

Overview of the AVR series

COMMUNICATION STANDARD, CIRCUIT EXAMPLE AND COMMUNICATION STANDARD

Type	Dimensions code JIS [EIA]	LIN/CXPI	Classical CAN	CAN/CAN-FD
		20 kbps	1 Mbps	2-8 Mbps
Chip varistors	1005 [0402]	N/A	AVRH10C270KT150NA8	AVRH10C270KT150NA8
	1608 [0603]	AVRM1608C270KT221M	AVR-M1608C270MTAAB	AVR-M1608C270MTABB
	2012 [0805]	N/A	N/A	N/A

Type	Dimensions code JIS [EIA]	FlexRay	MOST50	USB2.0
		10 Mbps	50 Mbps	480 Mbps
Chip varistors	1005 [0402]	AVRH10C270KT150NA8	AVRH10C270KT150NA8	AVRL101D3R3FTA
	1608 [0603]	AVR-M1608C270MTABB	AVR-M1608C270MTAAB	AVRL161D3R3FTA
	2012 [0805]	N/A	N/A	N/A

Type	Dimensions code JIS [EIA]	One-Pair Ethernet 100BASE-T1	One-Pair Ethernet 1000BASE-T1	Motors
		100Mbps	1000Mbps	-
Chip varistors	1005 [0402]	AVRH10C101KT4R7FA8	AVRH10C101KT1R1NE8 AVRH10C221KT1R5YA8	N/A
	1608 [0603]	N/A	N/A	AVR-M1608C270KT6AB
	2012 [0805]	N/A	N/A	AVR-M2012C390KT6AB

Please be sure to request delivery specifications that provide further details on the features and specifications of the products for proper and safe use.
Please note that the contents may change without any prior notice due to reasons such as upgrading.

Chip varistors

Automotive grade

Product compatible with RoHS directive
Compatible with lead-free solders
AEC-Q200

Overview of the AVR series

PART NUMBER CONSTRUCTION

AVRM	1608		C	390		K		T		271		N				
Series name	L x W dimensions (mm)		Structure code		Varistor voltage (V)		Varistor voltage tolerance (%)		Packaging style		Capacitance or internal special symbol (pF)		Capacitance tolerance (%)			
AVRM series	1608	1.6x0.8	C	General structure		390=39x10 ⁰		K	±10	T	Taping		271=27x10 ¹		K	±10
	2012	2.0x1.2			220	22	M	±20	B	Bulk		221	220	M	±20	
					270	27	N	±30			271	270	N	±30		
					390	39										

AVR-M	1608		C	270		M		T		AAB		
Series name	L x W dimensions (mm)		Structure code		Varistor voltage (V)		Varistor voltage tolerance (%)		Packaging style		Company special symbol	
AVR-M series	1608	1.6x0.8	C	General structure		270=27x10 ⁰		K	±10	T	Taping	
	2012	2.0x1.2			220	22	M	±20	B	Bulk		
					270	27	N	±30				
					390	39						

AVRL	10		1A		3R3		F		T		A	
Series name	L x W dimensions (mm)		Maximum continuous voltage (Vdc)		Capacitance (pF)		Capacitance tolerance (pF)		Packaging style		Company special symbol	
AVRL series	10	1.0x0.5	1A	10	3R3	3.3	F	±1	T	Taping		
L=Low cap	16	1.6x0.8			6R8	6.8	G	±2	B	Bulk		

AVRH	10		C	270		K		T		150		N		A		8				
Series name	L x W dimensions (mm)		Structure code		Varistor voltage (V)		Varistor voltage tolerance (%)		Packaging style		Capacitance (pF)		Capacitance tolerance		ESD voltage amount IEC61000-4-2 (kV)		Operating temperature limit (°C)			
AVRH series	10	1.0x0.5	C	General structure		270=27x10 ⁰		K	±10	T	Taping		150=15x10 ⁰		N	±30%	A	25	8	150
H=High Reliability					270	27			B	Bulk		150	15	F	±1pF					
					390	39					500	50								
					101	100					4R7	4.7								



Shape symbol(JIS)	L	W	T	B
1005	1.00±0.05	0.50±0.05	0.50±0.05	0.1min.
1608	1.60±0.1	0.80±0.1	0.80±0.1	0.2min.
2012	2.00±0.2	1.25±0.2	1.00±0.2	0.2min.

⚠ Please be sure to request delivery specifications that provide further details on the features and specifications of the products for proper and safe use.
Please note that the contents may change without any prior notice due to reasons such as upgrading.

Chip varistors

Automotive grade

Product compatible with RoHS directive
Compatible with lead-free solders
AEC-Q200

Overview of the AVR series

OPERATING TEMPERATURE RANGE, PACKAGE QUANTITY, PRODUCT WEIGHT

Type	Temperature range		Package quantity (pieces/reel)	Individual weight (mg)
	Operating temperature* (°C)	Storage temperature** (°C)		
AVRM1005 AVR-M1005 AVRL10	-40 to +125	-40 to +125	10,000	1.2
AVRH10				
AVRM1608 AVRL16 AVR-M1608 AVR-M2012	-40 to +125	-40 to +125	4,000	5
			2,000	13

* Operating temperature range includes self-temperature rise.

** The storage temperature range is for after the assembly.

TERMINOLOGY

Item	Unit	Description
Varistor voltage (Breakdown voltage)	V _{1mA} (V)	Chip varistor-terminal voltage when DC1mA was flowed
Maximum continuous voltage	V _{dc} (V)	DC voltage that is continuously applied between chip varistor terminals Terminal chip varistors leakage current-value: 50μA max Voltage appearing across the varistor when a pulse current (8/20μs ^{*1}) of specified peak value is applied.
Clamping voltage	V _{cl} (V)	Voltage between terminal chip varistors of the Specified peak current value of the impulse current(8/20μs ^{*1}) is applied
Maximum energy	E (Joule)	When applied specified peak impulse current-value current(10/1000μs ^{*2}) once, maximum energy that electrical property of chip varistors be not deteriorated
Maximum peak current	I _p (A)	When applied impulse current(8/20μs ^{*1}) once, maximum current that electrical property of chip varistors be not deteriorated
Capacitance	C (pF)	Oscillator frequency 1kHz or 1MHz, Capacitance between chip varistor-terminal in oscillator voltage 1V _{rms}

*1 8/20μs test waveform



*2 10/1000μs test waveform



Chip varistors

Automotive grade

Product compatible with RoHS directive

Compatible with lead-free solders

AEC-Q200

AVR series (Automotive grade)

Product characteristics list

PRODUCT CHARACTERISTICS LIST

Item	V1mA (V)	C1kHz * C1MHz (pF)	Vdc DC (V)	Clamping voltage 8/20µs Pulse Vcl (V)	Maximum energy 10/1000µs Pulse E (J)	Maximum peak current 8/20µs Pulse Ip (A)	IEC61000-4-2 (Contact) 150pF/330Ω
AVRL101D3R3FTA	27(21.6 to 32.4)	3.3(2.3 to 4.3)*	20	62(0.5A)	0.01	0.5	8kV
AVRL101D6R8GTA	27(21.6 to 32.4)	6.8(4.8 to 8.8)*	20	58(1A)	0.01	1	8kV
AVRH10C270KT150NA8	27(24.0 to 30.0)	15(10.5 to 19.5)	19	52(2A)	0.02	2	25kV
AVRH10C270KT350NA8	27(24.0 to 30.0)	35(24.5 to 45.5)	19	52(2A)	0.02	8	25kV
AVRH10C390KT500NA8	39(35.0 to 43.0)	50(35 to 65)	28	72(2A)	0.02	15	25kV
AVRH10C101KT4R7FA8	100(90 to 110)	4.7(3.7 to 5.7)*	70	190(1A)	0.03	1	25kV
AVRH10C101KT1R1NE8	110(100 to 120)	1.1(0.8 to 1.4)*	70	190 (0.3A)	0.01	0.3	8kV
AVRH10C221KT1R5YA8	220 (198 to 242)	1.5(1.37 to 1.63)*	70	400 (0.5A)	0.01	0.5	25kV
AVRL161D3R3FTA	27(21.6 to 32.4)	3.3(2.3 to 4.3)*	20	62(0.5A)	0.01	0.5	8kV
AVRL161D6R8GTA	27(21.6 to 32.4)	6.8(4.8 to 8.8)*	20	58(1A)	0.01	1	8kV
AVR-M1608C220KT2AB	22(19.8 to 24.2)	210(147 to 273)	16	37(2A)	0.03	10	25kV
AVR-M1608C220KT6AB	22(19.8 to 24.2)	560(392 to 728)	16	34(2A)	0.10	30	25kV
AVR-M1608C270MTABB	27(21.6 to 32.4)	15(10.5 to 19.5)	17	52(2A)	0.05	2	25kV
AVR-M1608C270MTAAB	27(21.6 to 32.4)	30(21 to 39)	17	52(2A)	0.05	2	25kV
AVR-M1608C270KTACB	27(24.0 to 30.0)	60(42 to 78)	19	54(2A)	0.05	10	25kV
AVRM1608C270KT800M	27(24.0 to 30.0)	80(64 to 96)	19	53(2A)	0.02	28	25kV
AVR-M1608C270KT2AB	27(24.0 to 30.0)	160(112 to 208)	19	42(2A)	0.10	20	25kV
AVRM1608C270KT221M	27(24.0 to 30.0)	220(176 to 264)	19	52(2A)	0.10	40	25kV
AVR-M1608C270KT6AB	27(24.0 to 30.0)	430(301 to 339)	19	42(2A)	0.10	48	25kV
AVRM1608C390KT271N	39(35.0 to 43.0)	270(189 to 351)	28	69(2A)	0.10	78	25kV
AVR-M2012C220KT6AB	22(19.8 to 24.2)	800(560 to 1040)	16	38(5A)	0.30	100	25kV
AVRM2012C330KT801N	33(29.7 to 36.3)	800(560 to 1040)	24	59(5A)	0.50	240	25kV
AVR-M2012C390KT6AB	39(35.0 to 43.0)	430(301 to 559)	28	62(5A)	0.30	100	25kV

 Please be sure to request delivery specifications that provide further details on the features and specifications of the products for proper and safe use.
Please note that the contents may change without any prior notice due to reasons such as upgrading.

Product compatible with RoHS directive
Compatible with lead-free solders
AEC-Q200

Chip varistors

Automotive grade

AVR series Electrostatic absorption characteristics

DISCHARGE VOLTAGE WAVEFORM (EXAMPLE)

WITHOUT VARISTOR, WAVEFORM AT VARISTOR INSTALLATION

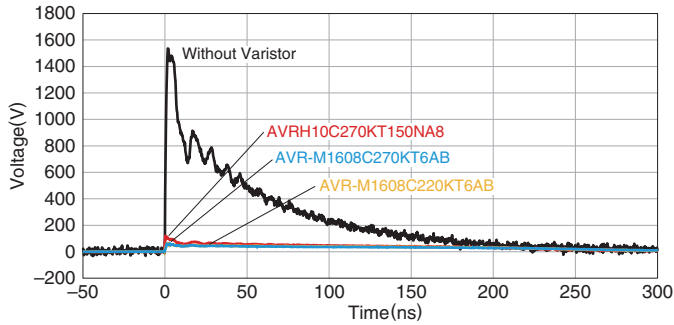

WAVEFORM AT VARISTOR INSTALLATION

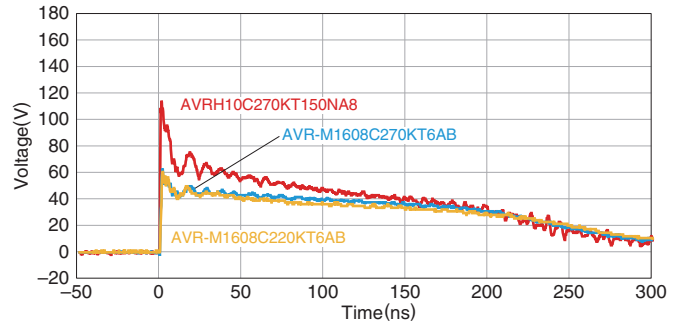

Test conditions

150pF/330Ω (IEC61000-4-2)

Contact discharge, Charged voltage 8kV

TEST CIRCUIT DIAGRAM

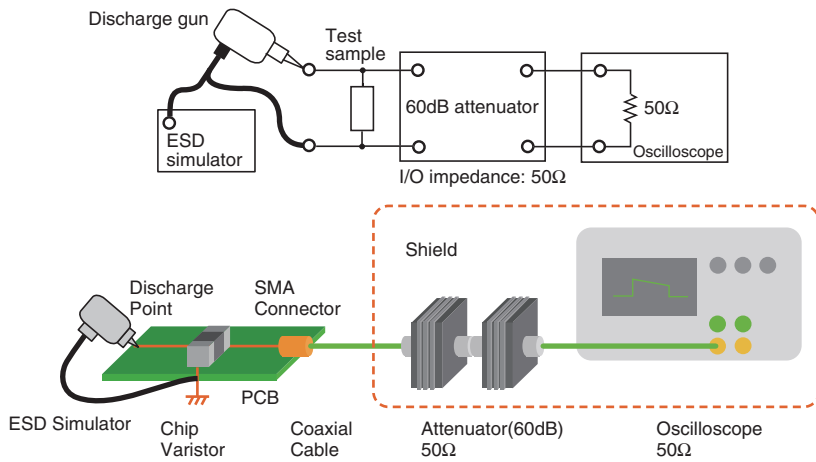

⚠ Please be sure to request delivery specifications that provide further details on the features and specifications of the products for proper and safe use.
Please note that the contents may change without any prior notice due to reasons such as upgrading.

Chip varistors

Automotive grade

Product compatible with RoHS directive
Compatible with lead-free solders
AEC-Q200

AVR series Electrostatic discharge tests

APPLIED VOLTAGE STEP(VOLTAGE 10TIMES APPLIED) **REPEATED VOLTAGE APPLICATION(~ 1000 times)**

AVRH10C270KT150NA8 (Voltage % change at reference current: within ±10%)



AVR-M1608C270MTAAB (Voltage % change at reference current: within ±10%)



AVR-M2012C390KT6AB (Voltage % change at reference current: within ±10%)



AVRL101D3R3FTA(Capacitance: 5pF or less)



* ESD condition: 150pF/330Ω(IEC61000-4-2)

⚠ Please be sure to request delivery specifications that provide further details on the features and specifications of the products for proper and safe use. Please note that the contents may change without any prior notice due to reasons such as upgrading.

Chip varistors

Automotive grade

Product compatible with RoHS directive
Compatible with lead-free solders
AEC-Q200

Attention on a circuit board design

Board design

When attached to chip varistors, amount of silver used (fillet size) has direct impact on chip varistors after mounting. Thus, sufficient consideration is necessary.

Set of land dimensions

(1) As the stress rises in the chip varistors owing to the increase in silver, breakage and cracks will occur. Cause including crack, as caution on board land design, configure the shape and dimensions so that the amount of silver is appropriate. If you installed 2 or more parts in the Common Land, separated by a solder resist and special land of each component.



Dimensions shape	Symbol		
	A	B	C
1005	0.30 to 0.50	0.35 to 0.45	0.40 to 0.60
1608	0.60 to 0.80	0.60 to 0.80	0.60 to 0.80
2012	0.90 to 1.20	0.70 to 0.90	0.90 to 1.20

(2) When peak levels panning-at soldering is excessive, by solder contraction stress, mechanical-thermal stress causes a Yasuko chip crack. In addition, when the peak level is underestimated, terminal electrode fixed strength is insufficient. This causes chip dropouts and may affect circuit reliability. Representative example of the panning of peak levels is shown in the following.

Recommended silver dose

Solder volume overload		Solder stress is increased, and it is easy for a crack to form.
Decent solder volume		
Solder volume deficit		Fixed strength is weak, and there is connection a problem and risk of loss.

Case and suggested protocol want to avoid

Example	Cases to avoid	Improvement example (land division)
Lead wire and land of part discrete doubles up		
Arrangements in the vicinity		
Arrangements of chip component's companion		

 Please be sure to request delivery specifications that provide further details on the features and specifications of the products for proper and safe use. Please note that the contents may change without any prior notice due to reasons such as upgrading.

Product compatible with RoHS directive
Compatible with lead-free solders
AEC-Q200

Chip varistors Automotive grade

Attention on a circuit board design

Arrangements of components

(1) I was based on camber of substrate and suggested protocol of chip varistors arrangement, as stress does not join to the utmost is shown in following.

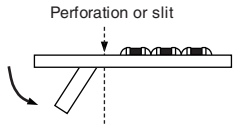
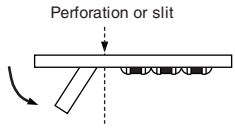
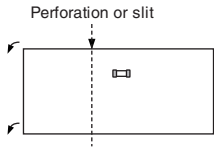
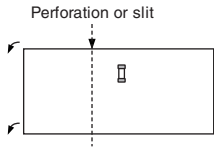
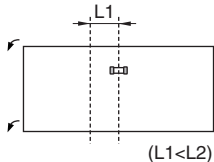
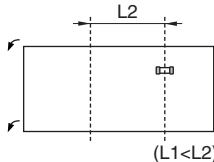
	Substrate for flexural stress Adverse events	Substrate for flexural stress Good example
Direction of surface solder	 <p>Solder the mountain fold as a top.</p>	 <p>Solder the mountain fold as a bottom. [Please review the italicized portion, as I am unsure what you mean to convey here.]</p>
Chip arrangements (direction)	 <p>Mounted vertically to the perforation and slit.</p>	 <p>Mounted horizontally to the perforation and slit.</p>
Distance from perforation and slit portion	 <p>($L1 < L2$)</p> <p>Close location is disadvantageous of perforation and slit.</p>	 <p>($L1 < L2$)</p> <p>It is an advantage so distant location away places the perforation and slit.</p>

(2) In payment near by board, depending on mount position of chip varistors, as mechanical stress varies, please refer to the following diagram.

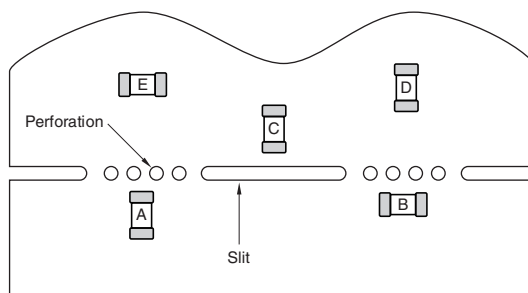

The order of $A > B = C > D > E$ eases the stress.

⚠ Please be sure to request delivery specifications that provide further details on the features and specifications of the products for proper and safe use. Please note that the contents may change without any prior notice due to reasons such as upgrading.

Product compatible with RoHS directive
Compatible with lead-free solders
AEC-Q200

Chip varistors

Automotive grade

Local precautions

Application to board

Mounting head pressure

Under suction nozzle if dead point too, during implementation, excessive force joins of chip varistors low, as cause of crack, please use with reference to something about following.

- 1) Being set to top surface of substrate so that under suction nozzle as for dead center, substrate does not bend back, and adjust, please.
- 2) Nozzle pressure at implementation is 0.1 to 0.3N in static load, please.
- 3) Substrate fixes up back surface of substrate with support pin in impact of suction nozzle to wely deflection to the utmost, and substrate hold deflection, please. A representative example is shown in the following.



Mechanical shock that, if positioning your nail to wear, ragged edge of positionings, participates in chip varistors are locally, and chip varistors, as there is possibility of crack generated, cut the closed positioning, and maintenance and inspection, and, exchange of manage dimensions and position nail periodically, please.

Soldering

Significant impact is possible on the performance of chip varistors, flux checks something about follow, please use.

- (1) Flux uses one with 0.1wt % (Cl conversion) or less halide substance contains amounts, please. In addition, do not do this with strongly acidic objects.
- Flux during is soldered (2) Chip varistors is applied the smallest amount necessary, please.
- (3) If Used soluble flux, perform thorough wash particularly, please.

Reflow temperature profile



Item	Specification	
	For eutectic mixture solder	Use of lead-free solder
Preheating temperature	160 to 180°C	150 to 180°C
Solder melting temperature	200°C	230°C
Maximum temperature	240°C max.	260°C max.
Preheating time	100s max.	120s max.
Time to reach higher than the solder melting temperature	30s max.	40s max.
number of possible reflow cycles	2 max.	2 max.

Soldering iron

The tip temperature and also by (1) types of soldering irons, the size of the substrate, and the geometry of the land pattern. Being earlier, but when as there is possibility that crack occurs in the heat anderson impaction, point soldering iron temperature is high, please do solder work within the following conditions.

Temperature of iron tips (°C)	Wattage (W)	Palat point shape (mm)	Soldering time (Second)	Frequency
350max.	30max.	ø3.0max.	5 max.	Within each terminal once (Within total of twice)

Direct iron tip is in contact with the (2) chip varistors body, and the strain owing to thermal shock in particular grows even if a crack is generated. Therefore, please do not touch it directly to the terminal electrodes.

⚠ Please be sure to request delivery specifications that provide further details on the features and specifications of the products for proper and safe use. Please note that the contents may change without any prior notice due to reasons such as upgrading.

Chip varistors

Automotive grade

Product compatible with RoHS directive
Compatible with lead-free solders
AEC-Q200

Attention after implementation

Cleaning

- (1) If cleaning liquid is inappropriate, residues and other foreign body of fluxes builds up on chip varistors, and can degrade the performance of chip varistors (particularly the insulation resistance).
- (2) Wash conditions may compromise performance of chip varistors if they are improper (wash due, wash excess).

2-1) For wash due

- (a) By substance of a system in flux residue halide, metal including terminal electrodes may experience corrosion.
- (b) Substance of a system in flux residue halide builds up on chip varistors, and reduces the insulation resistance.
- (c) Soluble flux makes comparisons of colophony series flux, and there is event with trends of significant (1) and(2).

2-2) For excess wash

- (1) Owing to lavage, chip varistors deteriorates, and reduces performance of chip varistors.
- (2) In ultrasonography, when output is passed, substrate resonates size, and crack occurs in body and sprang of chip varistors in vibration of substrate. Since this may reduce the strength of the terminal electrode, please note the following conditions. [Please review the italicized portion, as I am unsure what you mean to convey here.]
 - Ultrasound output
 - Ultrasonic frequency
 - Ultrasound cleaning time

2-3) Concentration including halogen that when cleaning liquid to pollution, when you released is higher, and may cause similar of results into wash due.

Substrate handling after component mounting

- (1) When substrate is divided, a flexible so that show in following diagram to substrate, and is given by stress including twist, as there is possibility that crack occurs of chip varistors, please check that stress is within acceptable limits.



- (2) During each substrate operational check, push pressure with contact failure of check pin of boards checkers of check pin may be toned up to be prevented. As substrate is bent under loading, chip varistors is broken owing to stress. There is also the possibility that solder on the terminal electrode will peel off. Follow the diagram for reference, and check that the substrate bends, please.

Item	Cases to avoid	Recommended case
Substrate sags		

Single-part component handling

To drop impact, as there is possibility that breakage and crack is entered, do not chip varistors that(1) chip varistors falls.

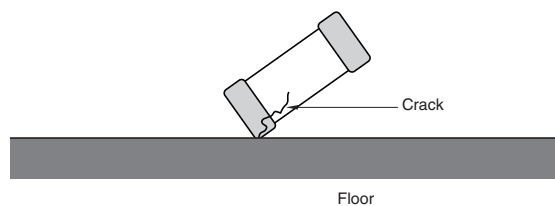

- (2) At stacking storage after implementation and treatment of substrate, corner of boards is regarded as chip varistors. Please be careful, as there is the possibility that breakage and cracks will occur on impact.



REMINDERS FOR USING THESE PRODUCTS

Before using these products, be sure to request the delivery specifications.

SAFETY REMINDERS

Please pay sufficient attention to the warnings for safe designing when using this products.

REMINDERS

- Please pay careful attention to the precautions and follow safe designing practices when using these products.
- Please observe the following precautions in order to avoid problems with chip varistors such as characteristic degradation and element destruction
 - Please store these products in an environment with a temperature of 5 to 40°C and humidity level of 20 to 70%RH, and use them within six months.
 - Poor storage conditions may lead to the deterioration of the solderability of the edge electrodes, so please be careful to avoid contact with humidity, dew condensation, dust, toxic gas (hydrogen, hydrogen sulfide, sulfurous acid, chlorine, ammonia, etc.), direct sunlight, and so on.
 - Please do not use products that have been dropped or detached when mounting.
 - Please solder with the reflow soldering method, and not the flow (dip) soldering method.
- Please observe the following precautions to avoid problems with varistors such as characteristic degradation and element destruction, which ultimately lead to the generation of heat and smoke with the elements.
 - Do not use in locations where the temperatures exceed the operating temperature range such as under direct sunlight or near sources of heat.
 - Do not use in locations where there are high levels of humidity such as under direct exposure to weather and areas where steam is released.
 - Do not use in locations such as dusty areas, high-saline environments, places where the atmosphere is contaminated with corrosive gas, etc.
 - Avoid powerful vibrations, impact (such as by dropping), pressure, etc. that may lead to splitting in the products.
 - Do not use with a voltage that exceeds the maximum allowable circuit voltage.**
 - When resin coating (including modular) a varistor, do not use a resin that will cause deterioration of the varistor. Be sure never to use resin that generates hydrogen as palladium is used for the inner electrode.
 - Avoid attachment near combustible materials.
- Please contact our sales offices when considering the use of the products listed on this catalog for applications, whose performance and/or quality require a more stringent level of safety or reliability, or whose failure, malfunction or trouble could cause serious damage to society, person or property ('specific uses' such as automobiles, airplanes, medical instruments, nuclear devices, etc.) as well as when considering the use for applications that exceed the range and conditions of this catalog.
 - Please also contact us when using these products for automotive applications.
- As range of catalog, conditions are transcended, or for damage that generated by was used in application specific, etc, accept no the responsibility, wish.
- Please take appropriate measures such as acquiring protective circuits and devices that meet the uses, applications, and conditions of the instruments and keeping backup circuits.

Компания «Life Electronics» занимается поставками электронных компонентов импортного и отечественного производства от производителей и со складов крупных дистрибьюторов Европы, Америки и Азии.

С конца 2013 года компания активно расширяет линейку поставок компонентов по направлению коаксиальный кабель, кварцевые генераторы и конденсаторы (керамические, пленочные, электролитические), за счёт заключения дистрибьюторских договоров

Мы предлагаем:

- Конкурентоспособные цены и скидки постоянным клиентам.
- Специальные условия для постоянных клиентов.
- Подбор аналогов.
- Поставку компонентов в любых объемах, удовлетворяющих вашим потребностям.
- Приемлемые сроки поставки, возможна ускоренная поставка.
- Доставку товара в любую точку России и стран СНГ.
- Комплексную поставку.
- Работу по проектам и поставку образцов.
- Формирование склада под заказчика.
- Сертификаты соответствия на поставляемую продукцию (по желанию клиента).
- Тестирование поставляемой продукции.
- Поставку компонентов, требующих военную и космическую приемку.
- Входной контроль качества.
- Наличие сертификата ISO.

В составе нашей компании организован Конструкторский отдел, призванный помогать разработчикам, и инженерам.

Конструкторский отдел помогает осуществить:

- Регистрацию проекта у производителя компонентов.
- Техническую поддержку проекта.
- Защиту от снятия компонента с производства.
- Оценку стоимости проекта по компонентам.
- Изготовление тестовой платы монтаж и пусконаладочные работы.



Тел: +7 (812) 336 43 04 (многоканальный)
Email: org@lifeelectronics.ru