

PLEASE CHECK WWW.MOLEX.COM FOR LATEST PART INFORMATION

Part Number: [0877159913](#)
Status: **Active**
Overview:
Description: 1.00mm (.039") Pitch, PCI Express* Connector, 164 Circuits, Nylon 4/6 Glass-filled, Black Housing, Copper Alloy, 0.76µm (30µ") Gold (Au) Plating, with Beveled Metal Pins, 3.00mm (.118") Solderetail, Lead Free

Agency Certification

CSA LR19980
 UL E29179

General

Product Family Edge Card Connectors
 Series 87715
 Comments PCI 16 lanes
 Component Type Edgecard to PCB
 Overview pci_express_card_edge_connector
 Product Name PCI Express*

Physical

Circuits (Loaded) 164
 Circuits (maximum) 164
 Circuits Detail All Signal
 Durability (mating cycles max) 50
 Entry Angle Vertical (Top Entry)
 Flammability 94V-0
 Keying to Mating Part Yes
 Material - Plating Mating Gold
 Material - Plating Termination Tin
 PC Tail Length (in) 0.100 In
 PC Tail Length (mm) 2.54 mm
 PCB Locator Yes
 PCB Retention Yes
 PCB Thickness Recommended (in) 0.062 In
 PCB Thickness Recommended (mm) 1.60 mm
 Packaging Type Tray
 Pitch - Mating Interface (in) 0.039 In
 Pitch - Mating Interface (mm) 1.00 mm
 Pitch - Term. Interface (in) 0.039 In
 Pitch - Term. Interface (mm) 1.00 mm
 Plating min: Mating (µin) 30
 Plating min: Mating (µm) 0.76
 Plating min: Termination (µin) 100
 Plating min: Termination (µm) 2.50
 Polarized to Mating Part Yes
 Temperature Range - Operating -55°C to +85°C
 Termination Interface: Style Through Hole

Electrical

Current - Maximum per Contact 1.1A
 Voltage - Maximum 50V AC (RMS)/DC

Material Info

Reference - Drawing Numbers

Packaging Specification PK-87715-205
 Product Specification PS-87715-200

EU RoHS
ELV and RoHS
Compliant
REACH SVHC
 Not Reviewed
Halogen-Free
Status
Not Reviewed

China RoHS



Need more information on product environmental compliance?

Email productcompliance@molex.com
 For a multiple part number RoHS Certificate of Compliance, [click here](#)

Please visit the [Contact Us](#) section for any non-product compliance questions.

Search Parts in this Series
 87715Series

Mates With
 PCI Express Card

Sales Drawing
Test Summary

SD-87715-211
TS-87715-211

* PCI Express is a registered trademark of PCI-SIG®

This document was generated on 06/04/2010

PLEASE CHECK WWW.MOLEX.COM FOR LATEST PART INFORMATION

10 9 8 7 6 5 4 3 2 1

PART NUMBER	DIM A	CONTACT AREA PLATING OPTION	SOLDERTAIL PLATING OPTION	PROT SIZE	TOTAL CKTS SIZE
87715-9912	2.54	30 MICROINCH MIN. GOLD	100 MICROINCH MIN. TIN OVER NICKEL PLATED OVERALL	16	164
87715-9913	3.00	30 MICROINCH MIN. GOLD	100 MICROINCH MIN. TIN OVER NICKEL PLATED OVERALL	16	164

PIN #A1 IDENTIFIER

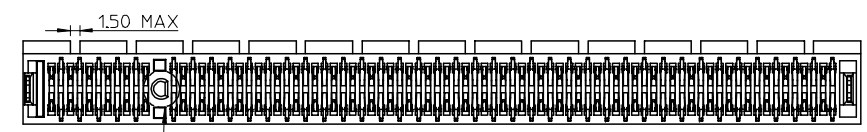
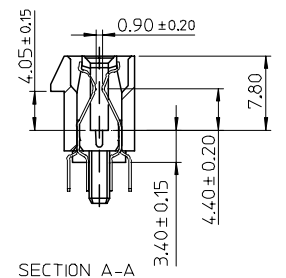
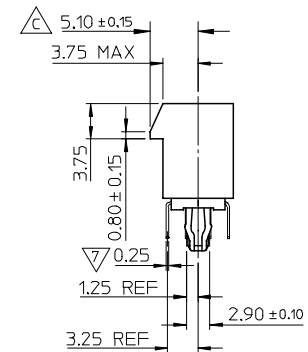
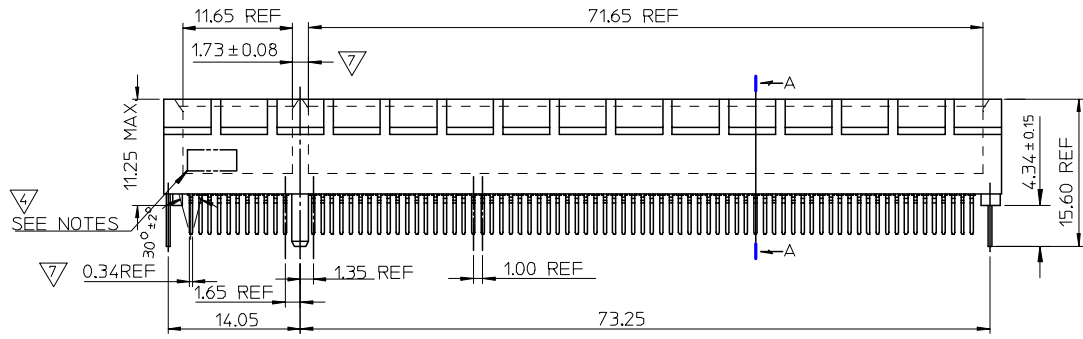
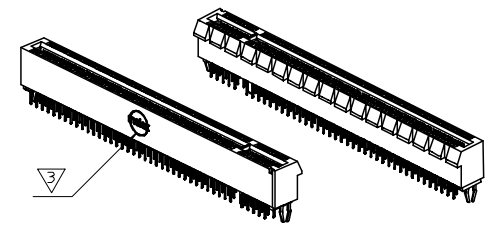
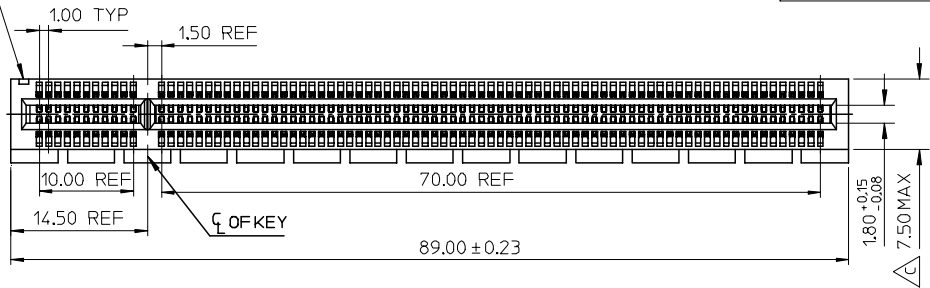

SEE DETAIL 1

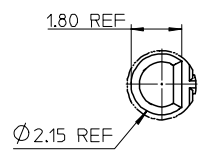

DETAIL 1

REVISED DRAWING EC NO: SH2006-0769 DRWN: ALLIN 2006/05/30 CHKD: 2006/06/07 APPR: WMSCHANG 2006/06/08	QUALITY SYMBOLS ▽=0 ◻=0	GENERAL TOLERANCES (UNLESS SPECIFIED)		DIMENSION STYLE MM ONLY	SCALE	DESIGN UNITS METRIC	THIRD ANGLE PROJECTION
		4 PLACES ± --- ± --- 3 PLACES ± --- ± --- 2 PLACES ± 0.25 ± --- 1 PLACE ± 0.25 ± ---	mm INCH	DRAWN BY DATE KEN LEE 2006/03/22	TITLE PCI EXPRESS X16 (164CKT) VERT DIP WITH BOARD LOCK (LEAD FREE VERSION)		
		DRAFT WHERE APPLICABLE MUST REMAIN WITHIN DIMENSIONS		CHECKED BY DATE ALLEN LIN 2006/03/22	MOLEX INCORPORATED		
		SEE TABLE		APPROVED BY DATE WILSON CHANG 2006/03/22	DOCUMENT NO. SD-87715-211		
				MATERIAL NO.	SHEET NO. 1 OF 3		

9 8 7 6 5 4 3 2 1

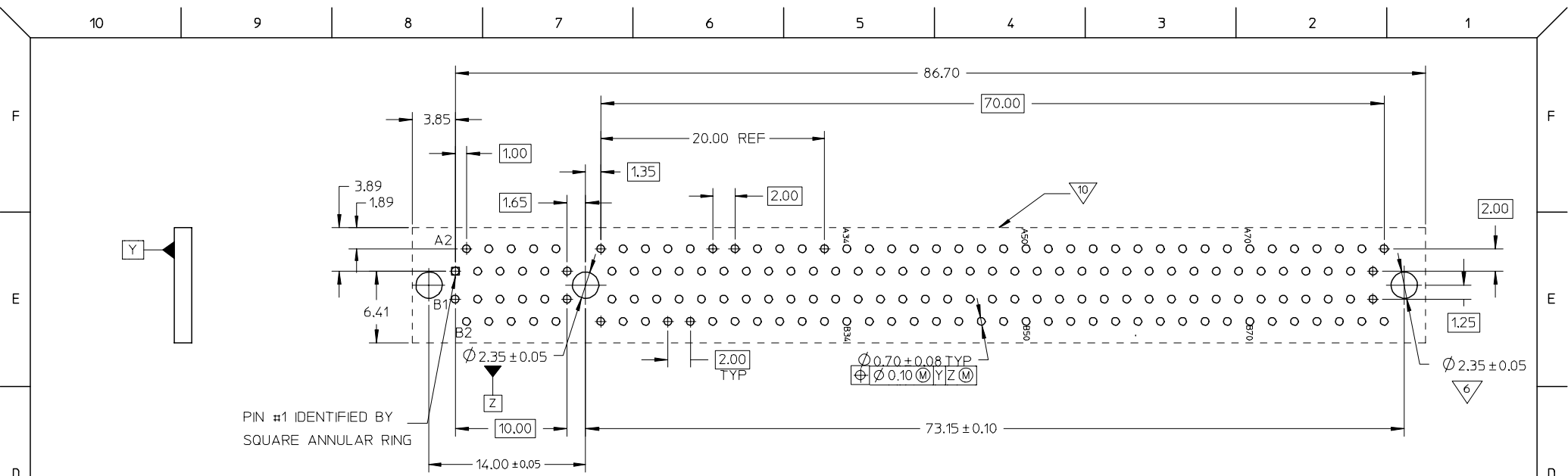

PIN #1 IDENTIFIED BY SQUARE ANNULAR RING

NOTES:

1. MATERIALS: HOUSING - HIGH TEMPERATURE THERMOPLASTIC, UL 94-V0 (BLACK)
TERMINAL - COPPER ALLOY
2. PLATING: CONTACT AREA - SEE TABLE IN SHEET 2 FOR PLATING OPTION
SOLDER TAILS - SEE TABLE IN SHEET 2 FOR PLATING OPTION
UNDERPLATING - 50µ (1.27µm) MIN. NICKEL

RECOMMENDED P.C.B. PATTERN (CONNECTOR SIDE)

THICKNESS: 1.57mm FOR 2.54mm SOLDER TAIL LENGTH
2.35mm FOR 3.00mm SOLDER TAIL LENGTH

11. PRODUCT SPECIFICATION REFER TO PS-87715-200.
12. PACKAGE SPECIFICATION REFER TO PK-87715-205.
13. TEST SUMMARY REFER TO TS-87715-211.
14. LEAD FREE AND RoHS COMPLIANT PRODUCT.

3. MOLEX LOGO - TO BE LASER-MARKED
4. DATE CODE - TO BE LASER-MARKED
5. CHAMFER EDGES OF EDGE CARD MUST BE FREE OF CUTTING BURRS
6. THE HORIZONTAL AXIS FOR THE FOOTPRINT HOLE PATTERN IS ESTABLISHED BY A LINE THROUGH THE CENTRE OF THE TWO Ø2.35 HOLES. THE VERTICAL AXIS IS 90° TO THE HORIZONTAL AXIS, THROUGH THE CENTRE OF DATUM Z
7. FEATURES DESIGNED TO FUNCTIONALLY MATE/MOUNT (SLIP FIT) PER THE RECOMMENDED EDGE CARD AND PCB PATTERN.
8. PINS FOR HOT PLUG PRESENCE DETECTION. NO TIE BAR PERMITTED FROM CARD EDGE TO LEADING EDGE OF PAD FOR THE HOT PLUG PINS.
9. PIN #1 IDENTIFIER
10. KEEP OUT AREA - NO EXTERNAL COMPONENTS ALLOWED ON PCB SURFACE

SEE SHEET 1	DESCRIPTION
EC NO: SH2006-0769	2006/05/30
DRWN: ALLIN	2006/06/07
CHKD:	
APPR: WISCHANG	2006/06/08
REV	

QUALITY SYMBOLS	▽=0
	◻=0

GENERAL TOLERANCES (UNLESS SPECIFIED)	mm	INCH
4 PLACES	± ---	± ---
3 PLACES	± ---	± ---
2 PLACES	± 0.25	± ---
1 PLACE	± 0.25	± ---
ANGULAR ± 3°		
DRAFT WHERE APPLICABLE MUST REMAIN WITHIN DIMENSIONS		

DIMENSION STYLE		SCALE	DESIGN UNITS	THIRD ANGLE PROJECTION
MM ONLY			METRIC	
DRAWN BY	DATE	TITLE		
KEN LEE	2006/03/22	PCI EXPRESS X16 (164CKT) VERT DIP WITH BOARD LOCK (LEAD FREE VERSION)		
CHECKED BY	DATE	MOLEX MOLEX INCORPORATED		
ALLEN LIN	2006/03/22			
APPROVED BY	DATE	DOCUMENT NO.		
WILSON CHANG	2006/03/22	SD-87715-211		
MATERIAL NO.		SHEET NO.		
		2 OF 3		
SIZE	THIS DRAWING CONTAINS INFORMATION THAT IS PROPRIETARY TO MOLEX INCORPORATED AND SHOULD NOT BE USED WITHOUT WRITTEN PERMISSION			
A3				

10 9 8 7 6 5 4 3 2 1

F F

E E

D D

C C

B B

A A

9 8 7 6 5 4 3 2 1

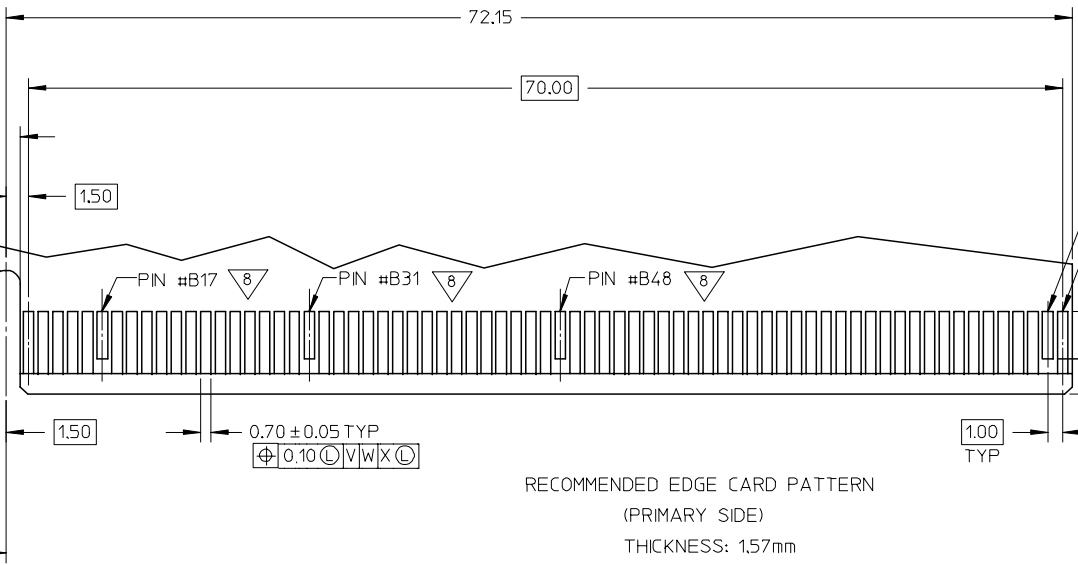

RECOMMENDED EDGE CARD PATTERN
(PRIMARY SIDE)
THICKNESS: 1.57mm

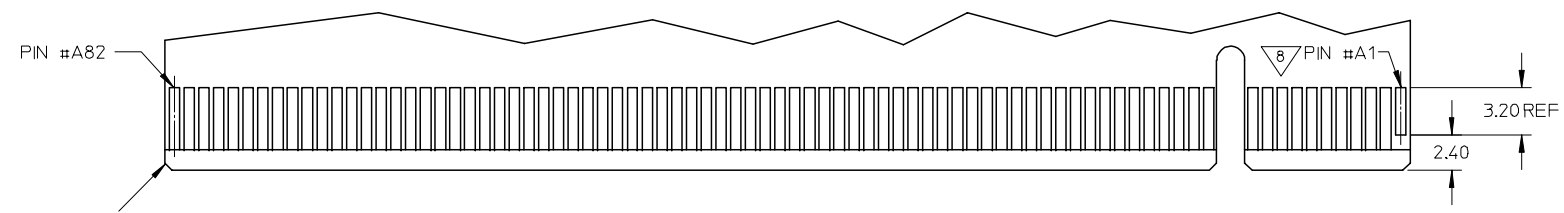
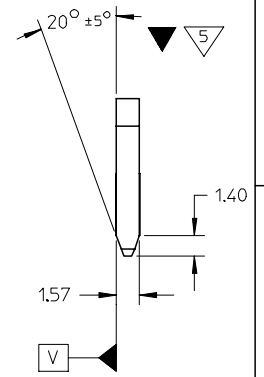

RECOMMENDED EDGE CARD PATTERN
(SECONDARY SIDE)
THICKNESS: 1.57mm

C0.50 x 45°(LX)

SEE SHEET 1	DESCRIPTION
EC NO: SH2006-0769	2006/05/30
DRWN: ALLIN	2006/06/07
CHKD:	
APPR: WMSCHANG	2006/06/08
REV	

QUALITY SYMBOLS	▽=0
	▽=0

GENERAL TOLERANCES (UNLESS SPECIFIED)	mm	INCH
	4 PLACES ± ---	± ---
	3 PLACES ± ---	± ---
	2 PLACES ± 0.25	± ---
	1 PLACE ± 0.25	± ---
	ANGULAR ± 3°	
DRAFT WHERE APPLICABLE MUST REMAIN WITHIN DIMENSIONS		

DIMENSION STYLE		SCALE	DESIGN UNITS	THIRD ANGLE PROJECTION
MM ONLY			METRIC	
DRAWN BY	DATE	TITLE		
KEN LEE	2006/03/22	PCI EXPRESS X16 (164CKT) VERT DIP WITH BOARD LOCK (LEAD FREE VERSION)		
CHECKED BY	DATE	MOLEX INCORPORATED		
ALLEN LIN	2006/03/22	MOLEX INCORPORATED		
APPROVED BY	DATE	DOCUMENT NO.		
WILSON CHANG	2006/03/22	SD-87715-211		
MATERIAL NO.		SHEET NO.		
SEE TABLE		3 OF 3		

SIZE		THIS DRAWING CONTAINS INFORMATION THAT IS PROPRIETARY TO MOLEX INCORPORATED AND SHOULD NOT BE USED WITHOUT WRITTEN PERMISSION		
A3				

Компания «Life Electronics» занимается поставками электронных компонентов импортного и отечественного производства от производителей и со складов крупных дистрибьюторов Европы, Америки и Азии.

С конца 2013 года компания активно расширяет линейку поставок компонентов по направлению коаксиальный кабель, кварцевые генераторы и конденсаторы (керамические, пленочные, электролитические), за счёт заключения дистрибьюторских договоров

Мы предлагаем:

- Конкурентоспособные цены и скидки постоянным клиентам.
- Специальные условия для постоянных клиентов.
- Подбор аналогов.
- Поставку компонентов в любых объемах, удовлетворяющих вашим потребностям.
- Приемлемые сроки поставки, возможна ускоренная поставка.
- Доставку товара в любую точку России и стран СНГ.
- Комплексную поставку.
- Работу по проектам и поставку образцов.
- Формирование склада под заказчика.
- Сертификаты соответствия на поставляемую продукцию (по желанию клиента).
- Тестирование поставляемой продукции.
- Поставку компонентов, требующих военную и космическую приемку.
- Входной контроль качества.
- Наличие сертификата ISO.

В составе нашей компании организован Конструкторский отдел, призванный помогать разработчикам, и инженерам.

Конструкторский отдел помогает осуществить:

- Регистрацию проекта у производителя компонентов.
- Техническую поддержку проекта.
- Защиту от снятия компонента с производства.
- Оценку стоимости проекта по компонентам.
- Изготовление тестовой платы монтаж и пусконаладочные работы.



Тел: +7 (812) 336 43 04 (многоканальный)
Email: org@lifeelectronics.ru