

# SPVQ8 Water-proof Type

Industry's smallest size, with main unit dimensions of 8.3×5.3×7mm

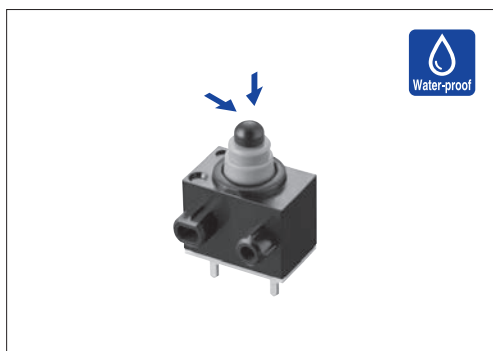

## Typical Specifications



Items		Specifications
Rating (max.)/(min.) (Resistive load)		0.1A 12V DC / 50μA 5V DC
Contact resistance (Initial / After operating life)		500mΩ max. / 1Ω max. (Standard type) 500mΩ max. / 3Ω max. (Long-life type)
Operating force		1±0.5N
Operating life	Without load	300,000cycles (Standard type) 1,000,000cycles (Long-life type)
	With load	300,000cycles (Standard type) 1,000,000cycles (Long-life type)

## Product Line

Poles	Positions	Circuit	Terminal type	Main body form	Minimum order unit (pcs)		Packing specifications type	Product No.		Drawing No.
					Japan	Export		Standard type	Long-life type	
1	1	N.O.	For PC board	Boss-both sides	1,755	7,020	A	<b>SPVQ810101</b>	<b>SPVQ830101</b>	1
			Angle	Boss-single side				<b>SPVQ810301</b>	<b>SPVQ830301</b>	2
				Without boss				<b>SPVQ810401</b>	<b>SPVQ830401</b>	3
			For PC board	Boss-single side				<b>SPVQ810501</b>	<b>SPVQ830501</b>	4
			For Lead	Boss-single side				<b>SPVQ810601</b>	<b>SPVQ830601</b>	5
				Boss-both sides				<b>SPVQ810703</b>	<b>SPVQ830701</b>	6
			Press fit	Boss-both sides				<b>SPVQ810801</b>	<b>SPVQ830801</b>	7
				Boss-single side				<b>SPVQ811004</b>	<b>SPVQ831001</b>	8
			N.C.	For PC board				Boss-both sides	—	1
				Angle				Boss-single side	—	9
								Without boss	—	3
				For PC board				Boss-single side	—	4
		For Lead		Boss-single side	—	10				
				Boss-both sides	—	11				
		Press fit	Boss-both sides	—	7					
			Boss-single side	—	12					
		N.O.	With wire (Downwards)	Boss-single side	—	13				
			With wire (Downwards)	Boss-both sides	—	14				
			With wire (Left side)	Boss-single side	—	15				
			With wire (from side)	Boss-both sides	—	16				
			N.C.	With wire (Downwards)	Boss-single side	—	17			
				With wire (Downwards)	Boss-both sides	—	14			
		With wire (Left side)		Boss-single side	—	18				
		With wire (from side)		Boss-both sides	—	16				

## Notes

- ※ Products with a wire will be supplied as follows.
  - Unless specified, the length of the lead wire is 250mm. Color is either red or black. Please consult us for length modification.
  - Please specify circuits (N.O. or N.C.) for wired (side) types. Unless specified, the circuit will apply N.O.
  - Product with wire will be build-to-order.
- This unit cannot be used in water (IP67 rating, except for terminal).

## Packing Specifications

### Tray

Packing specifications type	Number of packages (pcs.)		Export package measurements (mm)
	1 case /Japan	1 case /export packing	
<b>A</b>	1,755	7,020	540×360×270

### Bulk

Packing specifications type	Number of packages (pcs.)		Export package measurements (mm)
	1 case /Japan	1 case /export packing	
<b>B</b>	400	1,600	555×375×223

Refer to P.73 for soldering conditions.

# SPVQ8 Water-proof Type

## Dimensions

Unit:mm

No.	Style	No.	Style
1		5	
2		6	
3		7	
4		8	

■ Dimensions

Unit:mm

No.	Style	No.	Style
9		12	
10		13	
11		14	

Detector  
Slide  
Push  
Rotary  
Power  
Dual-in-line Package Type  
General-purpose Type  
Water-proof Type  
Fast Switching Type

# SPVQ8 Water-proof Type

Detector  
 Slide  
 Push  
 Rotary  
 Power  
 Dual-in-line Package Type  
 General-purpose Type  
 Water-proof Type  
 Fast Switching Type

## Dimensions

Unit:mm

No.	Style	No.	Style
15		17	
16		18	

## Circuit Diagram



Recommended Unit Terminal Shape for Press-Fit Terminals (Normally Open)

Unit:mm

Style
-------

SPVQ811004, SPVQ831001



Recommended Unit Terminal Shape for Press-Fit Terminals (Normally Closed)











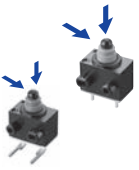

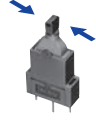
Unit:mm

Style
-------

SPVQ821004



- Detector
- Slide
- Push
- Rotary
- Power
- Dual-in-line  
Package Type
- General-  
purpose Type
- Water-proof  
Type
- Fast Switching  
Type

Series		Water-proof Type			Fast Switching Type		
		SPVQ8	SPVQ9	SSCN	SPVQ9	SPVQC	SPVQE
Photo							
Operation type		Two-way					
Dimensions (mm)	W	8.3	15.2	13	15.4	15.4	17.2
	D	5.3	6.4	5	8.4	7.4	12
	H	6.5	7.95	15	7.5	7.5	7.5
Operating temperature range		-40°C to +85°C					
Automotive use		●	●	●	●	●	●
Life cycle (availability)							
Poles / Positions		1/1	1/1 1/2	1/2	2/2	2/2	3/2
Rating (max.) (Resistive load)		0.1A 12V DC			50mA 26V DC	50mA 18V DC	
Rating (min.) (Resistive load)		50µA 5V DC		100µA 5V DC	50µA 5V DC		
Durability	Operating life without load	300,000cycles 1Ω max. or 1,000,000cycles 3Ω max.	300,000cycles 1Ω max.	100,000cycles 1Ω max.	300,000cycles 200mΩ max.		300,000 cycles CIRCUIT ①-②-③ and ④-⑤-⑥ 200mΩ max. CIRCUIT ⑦-⑧-⑨ 1Ω max.
	Operating life with load Rating (max.) (Resistive load)	300,000cycles 1Ω max. or 1,000,000cycles 3Ω max.	300,000cycles 1Ω max.	100,000cycles 1Ω max.	300,000cycles 200mΩ max.		300,000 cycles CIRCUIT ①-②-③ and ④-⑤-⑥ 200mΩ max. CIRCUIT ⑦-⑧-⑨ 1Ω max.
Electrical performance	Initial contact resistance	500mΩ max.			75mΩ max.		CIRCUIT ①-②-③ and ④-⑤-⑥ 75mΩ max. CIRCUIT ⑦-⑧-⑨ 250mΩ max.
	Insulation resistance	100MΩ min. 500V DC				100MΩ min. 250V DC	100MΩ min. 100V DC
	Voltage proof	500V AC for 1minute				250V AC for 1minute	100V AC for 1minute
Mechanical performance	Terminal strength	3N for 1minute (with terminal) Wire strength 30N for 1minute (with wire)	3N for 1minute				
	Actuator strength	20N		10N	20N		
Environmental performance	Cold	-40°C 500h					
	Dry heat	85°C 500h					
	Damp heat	60°C, 90 to 95% RH 500h					
Operation force		1±0.5N		2N max.	1±0.5N		
Page		61	66	69	70	71	72

Detector Switches Soldering Conditions . . . . . 73  
 Detector Switches Cautions . . . . . 74

**Note**  
 ● Indicates applicability to all products in the series.

# Detector Switches Soldering Conditions

## Example of Reflow Soldering Condition

1. Heating method: Double heating method with infrared heater.
2. Temperature measurement: Thermocouple  $\phi 0.1$  to  $0.2$  CA (K) or CC (T) at soldering portion (copper foil surface). A heat resisting tape should be used for fixed measurement.
3. Temperature profile



Series (Reflow type)	A (°C) 3s max.	B (°C)	C (s)	D (°C)	E (°C)	F (s)
<b>SPPB</b>	250	230	40	180	150	120
<b>SPPW8</b>			35			
<b>SPVE</b>	260		40			
<b>SPVL</b>						
<b>SPVM</b>						
<b>SPVN</b>						
<b>SPVR</b>						
<b>SPVS</b>						
<b>SPVT</b>						
<b>SSCM</b>						
<b>SSCQ</b>						
<b>SPVQC, SPVQE</b>	250					

### Notes

1. The condition mentioned above is the temperature on the mounting surface of a PC board. There are cases where the PC board's temperature greatly differs from that of the switch, surface depending on the PC board's material, size, thickness, etc. The above-stated conditions shall also apply to switch surface temperatures.
2. Soldering conditions differ depending on reflow soldering machines. Prior verification of soldering condition is highly recommended.

### Reference for Hand Soldering

Series	Soldering temperature	Soldering time
<b>SPVS, SPVN, SPVT, SPVM, SPVR, SPVE, SPPW8, SSCQ, SSCM, SPVL, SSCT, SPVQC, SPVQE</b>	350±5°C	3s max.
<b>SPVQ1, SPVQ3, SPVQ6, SPVQ7, SPVQ8, SPVQ9, SSCN, SPVQA</b>	300±10°C	3 + 1 / 0s
<b>SPPB (Reflow)</b>	300±5°C	5s max.
<b>SSCF, SPPB (For Lead, Dip)</b>	350±10°C	3 + 1 / 0s

### Reference for Dip Soldering

(For PC board terminal types)

Series	Items		Dip soldering	
	Preheating temperature	Preheating time	Soldering temperature	Duration of immersion
<b>SSCT, SPVQ1, SPVQ3, SPVQ6, SPVQ7, SPVQ8, SPVQ9, SPVQA</b>	100±10°C	60s max.	260±5°C	5±1s
<b>SPPW8, SPPB</b>	100 °C max.	60s max.	255±5°C	5±1s
<b>SSCF</b>	—		260±5°C	5±1s

Компания «Life Electronics» занимается поставками электронных компонентов импортного и отечественного производства от производителей и со складов крупных дистрибьюторов Европы, Америки и Азии.

С конца 2013 года компания активно расширяет линейку поставок компонентов по направлению коаксиальный кабель, кварцевые генераторы и конденсаторы (керамические, пленочные, электролитические), за счёт заключения дистрибьюторских договоров

Мы предлагаем:

- Конкурентоспособные цены и скидки постоянным клиентам.
- Специальные условия для постоянных клиентов.
- Подбор аналогов.
- Поставку компонентов в любых объемах, удовлетворяющих вашим потребностям.
- Приемлемые сроки поставки, возможна ускоренная поставка.
- Доставку товара в любую точку России и стран СНГ.
- Комплексную поставку.
- Работу по проектам и поставку образцов.
- Формирование склада под заказчика.
- Сертификаты соответствия на поставляемую продукцию (по желанию клиента).
- Тестирование поставляемой продукции.
- Поставку компонентов, требующих военную и космическую приемку.
- Входной контроль качества.
- Наличие сертификата ISO.

В составе нашей компании организован Конструкторский отдел, призванный помогать разработчикам, и инженерам.

Конструкторский отдел помогает осуществить:

- Регистрацию проекта у производителя компонентов.
- Техническую поддержку проекта.
- Защиту от снятия компонента с производства.
- Оценку стоимости проекта по компонентам.
- Изготовление тестовой платы монтаж и пусконаладочные работы.



Тел: +7 (812) 336 43 04 (многоканальный)

Email: [org@lifeelectronics.ru](mailto:org@lifeelectronics.ru)