

SPVQ8 Water-proof Type

Industry's smallest size, with main unit dimensions of 8.3×5.3×7mm



Typical Specifications



Items		Specifications
Rating (max.)/(min.) (Resistive load)		0.1A 12V DC / 50μA 5V DC
Contact resistance (Initial / After operating life)		500mΩ max. / 1Ω max. (Standard type) 500mΩ max. / 3Ω max. (Long-life type)
Operating force		1±0.5N
Operating life	Without load	300,000cycles (Standard type) 1,000,000cycles (Long-life type)
	With load	300,000cycles (Standard type) 1,000,000cycles (Long-life type)

Product Line

Poles	Positions	Circuit	Terminal type	Main body form	Minimum order unit (pcs)		Packing specifications type	Product No.		Drawing No.	
					Japan	Export		Standard type	Long-life type		
1	1	N.O.	For PC board	Boss-both sides	1,755	7,020	A	SPVQ810101	SPVQ830101	1	
			Angle	Boss-single side				SPVQ810301	SPVQ830301	2	
				Without boss				SPVQ810401	SPVQ830401	3	
			For PC board	Boss-single side				SPVQ810501	SPVQ830501	4	
			For Lead	Boss-both sides				SPVQ810601	SPVQ830601	5	
				Boss-single side				SPVQ810703	SPVQ830701	6	
			Press fit	Boss-both sides				SPVQ810801	SPVQ830801	7	
			N.C.	For PC board				Boss-single side	SPVQ811004	SPVQ831001	8
				Angle				Boss-both sides	SPVQ820101	—	1
								Boss-single side	SPVQ820301	—	9
				Without boss				SPVQ820401	—	3	
				For PC board				Boss-single side	SPVQ820501	—	4
		For Lead		Boss-both sides	SPVQ820601	—	10				
		N.O.	With wire (Downwards)	Boss-single side	SPVQ820704	—	11				
				Boss-both sides	SPVQ820801	—	7				
			With wire (Left side)	Boss-single side	SPVQ821004	—	12				
			With wire (from side)	Boss-both sides	SPVQ850100*	—	13				
				Boss-single side	SPVQ850200*	—	14				
			Press fit	Boss-both sides	SPVQ850300*	—	15				
		N.C.	With wire (Downwards)	Boss-single side	SPVQ850500*	—	16				
				Boss-both sides	SPVQ860100*	—	17				
			With wire (Left side)	Boss-single side	SPVQ860200*	—	14				
			With wire (from side)	Boss-both sides	SPVQ860300*	—	18				
				Boss-single side	SPVQ860500*	—	16				

Notes

- ※ Products with a wire will be supplied as follows.
 - Unless specified, the length of the lead wire is 250mm. Color is either red or black. Please consult us for length modification.
 - Please specify circuits (N.O. or N.C.) for wired (side) types. Unless specified, the circuit will apply N.O.
 - Product with wire will be build-to-order.
- This unit cannot be used in water (IP67 rating, except for terminal).

Packing Specifications

Tray

Packing specifications type	Number of packages (pcs.)		Export package measurements (mm)
	1 case /Japan	1 case /export packing	
A	1,755	7,020	540×360×270

Bulk

Packing specifications type	Number of packages (pcs.)		Export package measurements (mm)
	1 case /Japan	1 case /export packing	
B	400	1,600	555×375×223

Refer to P.73 for soldering conditions.

SPVQ8 Water-proof Type

Dimensions

Unit:mm

No.	Style	No.	Style
1		5	
2		6	
3		7	
4		8	

■ Dimensions

Unit:mm

No.	Style	No.	Style
9		12	
10		13	
11		14	

Detector

Slide

Push

Rotary

Power

Dual-in-line
Package Type

General-
purpose Type

Water-proof
Type

Fast Switching
Type

SPVQ8 Water-proof Type

Detector
 Slide
 Push
 Rotary
 Power
 Dual-in-line Package Type
 General-purpose Type
 Water-proof Type
 Fast Switching Type

Dimensions

Unit:mm

No.	Style	No.	Style
15		17	
16		18	

Circuit Diagram



Recommended Unit Terminal Shape for Press-Fit Terminals (Normally Open)

Unit:mm

Style

SPVQ811004, SPVQ831001

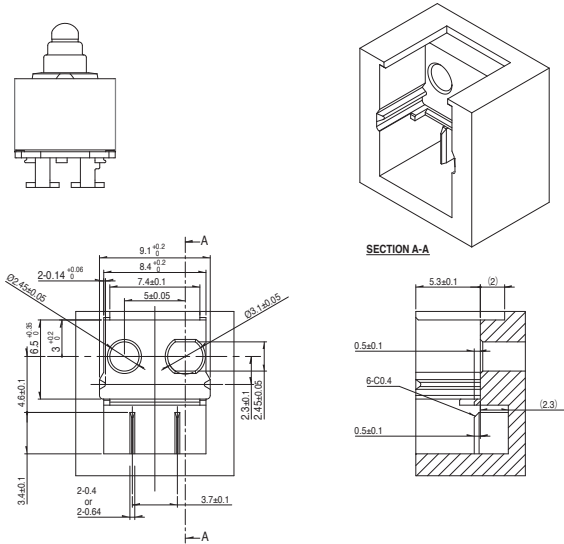

Recommended Unit Terminal Shape for Press-Fit Terminals (Normally Closed)

Unit:mm

Style

SPVQ821004

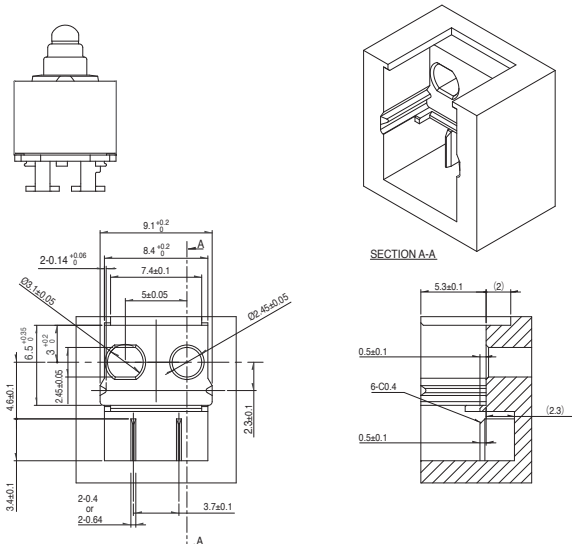

Detector

Slide

Push

Rotary











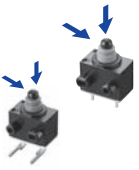

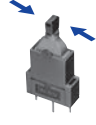
Power

Dual-in-line
Package Type

General-
purpose Type

Water-proof
Type

Fast Switching
Type

Series		Water-proof Type			Fast Switching Type		
		SPVQ8	SPVQ9	SSCN	SPVQ9	SPVQC	SPVQE
Photo							
Operation type		Two-way					
Dimensions (mm)	W	8.3	15.2	13	15.4	15.4	17.2
	D	5.3	6.4	5	8.4	7.4	12
	H	6.5	7.95	15	7.5	7.5	7.5
Operating temperature range		-40°C to +85°C					
Automotive use		●	●	●	●	●	●
Life cycle (availability)							
Poles / Positions		1/1	1/1 1/2	1/2	2/2	2/2	3/2
Rating (max.) (Resistive load)		0.1A 12V DC			50mA 26V DC	50mA 18V DC	
Rating (min.) (Resistive load)		50µA 5V DC		100µA 5V DC	50µA 5V DC		
Durability	Operating life without load	300,000cycles 1Ω max. or 1,000,000cycles 3Ω max.	300,000cycles 1Ω max.	100,000cycles 1Ω max.	300,000cycles 200mΩ max.		300,000 cycles CIRCUIT ①-②-③ and ④-⑤-⑥ 200mΩ max. CIRCUIT ⑦-⑧-⑨ 1Ω max.
	Operating life with load Rating (max.) (Resistive load)	300,000cycles 1Ω max. or 1,000,000cycles 3Ω max.	300,000cycles 1Ω max.	100,000cycles 1Ω max.	300,000cycles 200mΩ max.		300,000 cycles CIRCUIT ①-②-③ and ④-⑤-⑥ 200mΩ max. CIRCUIT ⑦-⑧-⑨ 1Ω max.
Electrical performance	Initial contact resistance	500mΩ max.			75mΩ max.		CIRCUIT ①-②-③ and ④-⑤-⑥ 75mΩ max. CIRCUIT ⑦-⑧-⑨ 250mΩ max.
	Insulation resistance	100MΩ min. 500V DC				100MΩ min. 250V DC	100MΩ min. 100V DC
	Voltage proof	500V AC for 1minute				250V AC for 1minute	100V AC for 1minute
Mechanical performance	Terminal strength	3N for 1minute (with terminal) Wire strength 30N for 1minute (with wire)	3N for 1minute				
	Actuator strength	20N		10N	20N		
Environmental performance	Cold	-40°C 500h					
	Dry heat	85°C 500h					
	Damp heat	60°C, 90 to 95% RH 500h					
Operation force		1±0.5N		2N max.	1±0.5N		
Page		61	66	69	70	71	72

Detector Switches Soldering Conditions 73
 Detector Switches Cautions 74

Note
 ● Indicates applicability to all products in the series.

Detector Switches Soldering Conditions

Example of Reflow Soldering Condition

1. Heating method: Double heating method with infrared heater.
2. Temperature measurement: Thermocouple $\phi 0.1$ to 0.2 CA (K) or CC (T) at soldering portion (copper foil surface). A heat resisting tape should be used for fixed measurement.
3. Temperature profile



Series (Reflow type)	A (°C) 3s max.	B (°C)	C (s)	D (°C)	E (°C)	F (s)
SPPB	250	230	40	180	150	120
SPPW8			35			
SPVE	260		40			
SPVL						
SPVM						
SPVN						
SPVR						
SPVS						
SPVT						
SSCM						
SSCQ						
SPVQC, SPVQE	250					

Notes

1. The condition mentioned above is the temperature on the mounting surface of a PC board. There are cases where the PC board's temperature greatly differs from that of the switch, surface depending on the PC board's material, size, thickness, etc. The above-stated conditions shall also apply to switch surface temperatures.
2. Soldering conditions differ depending on reflow soldering machines. Prior verification of soldering condition is highly recommended.

Reference for Hand Soldering

Series	Soldering temperature	Soldering time
SPVS, SPVN, SPVT, SPVM, SPVR, SPVE, SPPW8, SSCQ, SSCM, SPVL, SSCT, SPVQC, SPVQE	350±5°C	3s max.
SPVQ1, SPVQ3, SPVQ6, SPVQ7, SPVQ8, SPVQ9, SSCN, SPVQA	300±10°C	3 + 1 / 0s
SPPB (Reflow)	300±5°C	5s max.
SSCF, SPPB (For Lead, Dip)	350±10°C	3 + 1 / 0s

Reference for Dip Soldering

(For PC board terminal types)

Series	Items		Dip soldering	
	Preheating temperature	Preheating time	Soldering temperature	Duration of immersion
SSCT, SPVQ1, SPVQ3, SPVQ6, SPVQ7, SPVQ8, SPVQ9, SPVQA	100±10°C	60s max.	260±5°C	5±1s
SPPW8, SPPB	100 °C max.	60s max.	255±5°C	5±1s
SSCF	—		260±5°C	5±1s

Компания «Life Electronics» занимается поставками электронных компонентов импортного и отечественного производства от производителей и со складов крупных дистрибьюторов Европы, Америки и Азии.

С конца 2013 года компания активно расширяет линейку поставок компонентов по направлению коаксиальный кабель, кварцевые генераторы и конденсаторы (керамические, пленочные, электролитические), за счёт заключения дистрибьюторских договоров

Мы предлагаем:

- Конкурентоспособные цены и скидки постоянным клиентам.
- Специальные условия для постоянных клиентов.
- Подбор аналогов.
- Поставку компонентов в любых объемах, удовлетворяющих вашим потребностям.
- Приемлемые сроки поставки, возможна ускоренная поставка.
- Доставку товара в любую точку России и стран СНГ.
- Комплексную поставку.
- Работу по проектам и поставку образцов.
- Формирование склада под заказчика.
- Сертификаты соответствия на поставляемую продукцию (по желанию клиента).
- Тестирование поставляемой продукции.
- Поставку компонентов, требующих военную и космическую приемку.
- Входной контроль качества.
- Наличие сертификата ISO.

В составе нашей компании организован Конструкторский отдел, призванный помогать разработчикам, и инженерам.

Конструкторский отдел помогает осуществить:

- Регистрацию проекта у производителя компонентов.
- Техническую поддержку проекта.
- Защиту от снятия компонента с производства.
- Оценку стоимости проекта по компонентам.
- Изготовление тестовой платы монтаж и пусконаладочные работы.



Тел: +7 (812) 336 43 04 (многоканальный)
Email: org@lifeelectronics.ru