



Features

- Compact design, long life and high reliability
- Momentary push switch option
- Available in a wide variety of configurations to meet many user requirements



PEC12R - 12 mm Incremental Encoder

Electrical Characteristics

Output	2-bit quadrature code
Contact Rating	10 mA @ 5 VDC
Insulation Resistance	10 megohms @ 250 VDC
Dielectric Withstanding Voltage	
Sea Level	50 VAC minimum
Electrical Travel	Continuous
Contact Bounce (15 RPM)	2.0 ms. maximum**
RPM (Operating)	100 maximum**

Environmental Characteristics

Operating Temperature Range	-30 °C to +70 °C (-22 °F to +158 °F)
Storage Temperature Range	-40 °C to +85 °C (-40 °F to +185 °F)
Humidity	MIL-STD-202, Method 103B, Condition B
Vibration	10~55~10 Hz / 1 min. / Amplitude 1.5 mm
Shock	100 G
Rotational Life	30,000 cycles minimum
Switch Life	20,000 cycles minimum
IP Rating	IP 40

Mechanical Characteristics

Mechanical Angle	360 ° continuous
Torque	
Running	30.6 to 204 g-cm (0.42 to 2.83 oz.-in.)
Mounting	10.2 kgf.cm (8.83 lb.-in.) maximum
Shaft Side Load (Static)	2.04 kgf (4.5 lbs.) minimum
Weight	3 gm (0.1 oz.) maximum
Terminals	Printed circuit board terminals
Terminals	Printed circuit board terminals
Soldering Condition	
Wave Soldering	Sn95.5/Ag2.8/Cu0.7 solder with no-clean flux: 260 °C max. for 3 ± 1 sec.
Hand Soldering	Not recommended
Hardware	One flat washer and one mounting nut supplied with each encoder with bushing

Switch Characteristics

Switch Type	Contact Push ON Momentary SPST
Power Rating (Resistive Load)	10 mA at 5 V DC
Switch Travel	0.5 ± 0.3 mm
Switch Actuation Force	610 ± 306 gf (8.47 ± 4.24 oz.-in.)
Contact Resistance	100 milliohms @ 5 VDC

How To Order

PEC12R - 4 0 20 F - S 0012

Model	PEC12R - 4 0 20 F - S 0012
Terminal/Bushing Configuration	4 = Horizontal Mount - Axial PC Pin/No Bushing
	2 = Vertical Mount - Radial PC Pin/No Bushing
	3 = Horizontal Mount - Axial PC Pin/with Bushing
Detent Option	0 = No Detents
	1 = 12 Detents (available with 12 pulses only)
	2 = 24 Detents
Standard Shaft Length	22 = 22.5 mm
	17 = 17.5 mm
	20 = 20.0 mm
	25 = 25.0 mm
	30 = 30.0 mm
Shaft Style	F = Insulated Flatted Shaft
Switch Configuration	S = Push Momentary Switch
	N = No Switch
Resolution	0012 = 12 Pulses per 360 ° Rotation
	0024 = 24 Pulses per 360 ° Rotation

Quadrature Output Table

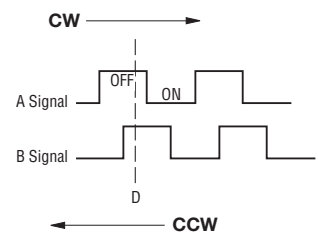

*RoHS Directive 2002/95/EC Jan. 27, 2003 including annex and RoHS Recast 2011/65/EU June 8, 2011.

**Devices are tested using standard noise reduction filters. For optimum performance, designers should use noise reduction filters in their circuits. Specifications are subject to change without notice.

The device characteristics and parameters in this data sheet can and do vary in different applications and actual device performance may vary over time. Users should verify actual device performance in their specific applications.

Applications

Level control, tuning and timer settings in:

- Audio-visual equipment
- Consumer electric appliances
- Musical instrumentation
- Communications equipment

PEC12R - 12 mm Incremental Encoder



Product Dimensions

PEC12R-2xxxF-Nxxxx (Vertical Mount - Radial PC Pin/No Bushing, No Switch)

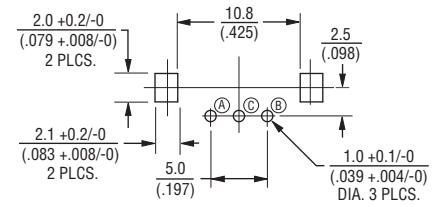
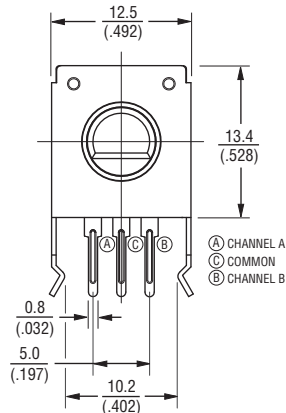
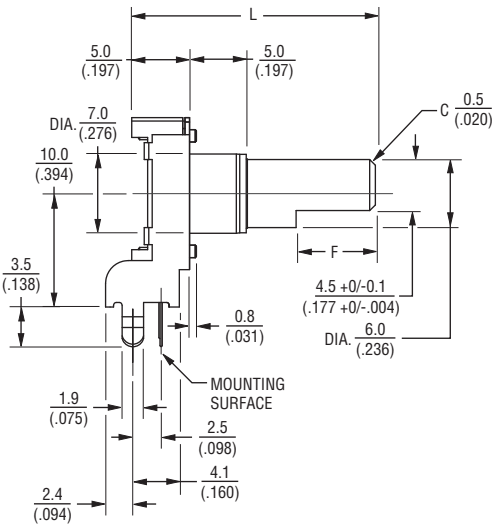

PEC12R-2xxxF-Sxxxx (Vertical Mount - Radial PC Pin/No Bushing, Push Momentary Switch)

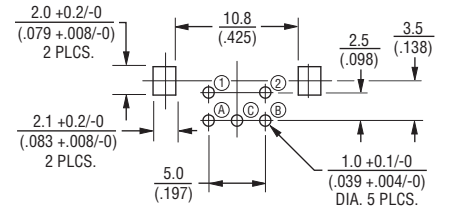
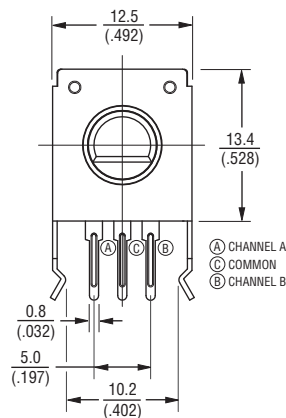
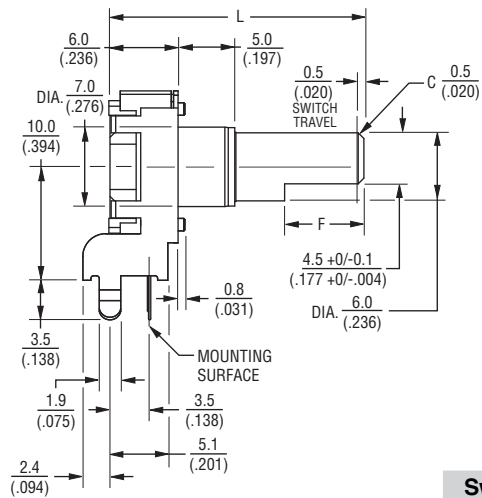

Switch Circuit



Suggested Filter Circuit

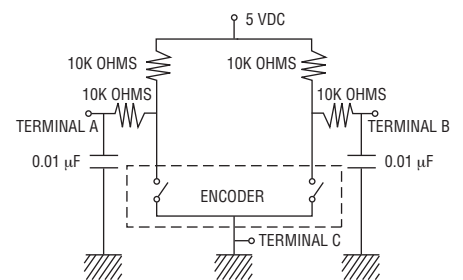

L	17.5 (.688)	20.0 (.787)	22.5 (.886)	25.0 (.984)	30.0 (1.181)
F	5.0 (.197)	7.0 (.276)	7.0 (.276)	12.0 (.472)	12.0 (.472)

DIMENSIONS: $\frac{\text{MM}}{\text{(INCHES)}}$

TOLERANCE: $\frac{<10}{(<.400)} = \frac{\pm 0.3}{(\pm .012)}$
 $\frac{\geq 10}{(\geq .400)} = \frac{\pm 0.5}{(\pm .020)}$

The device characteristics and parameters in this data sheet can and do vary in different applications and actual device performance may vary over time. Users should verify actual device performance in their specific applications.

Specifications are subject to change without notice.

PEC12R - 12 mm Incremental Encoder

BOURNS®

Product Dimensions

PEC12R-3xxxF-Nxxxx (Horizontal Mount - Axial PC Pin/with Bushing, No Switch)



PEC12R-3xxxF-Sxxxx (Horizontal Mount - Axial PC Pin/with Bushing, Push Momentary Switch)



L	17.5 (.688)	20.0 (.787)	22.5 (.886)	25.0 (.984)	30.0 (1.181)
LB	5.0 (.197)	5.0 (.197)	7.0 (.276)	7.0 (.276)	7.0 (.276)
F	5.0 (.197)	7.0 (.276)	7.0 (.276)	12.0 (.472)	12.0 (.472)

DIMENSIONS: $\frac{\text{MM}}{\text{(INCHES)}}$

TOLERANCE: $\frac{<10}{(<.400)} = \frac{\pm 0.3}{(\pm .012)}$

$\frac{\geq 10}{(\geq .400)} = \frac{\pm 0.5}{(\pm .020)}$

Specifications are subject to change without notice.

The device characteristics and parameters in this data sheet can and do vary in different applications and actual device performance may vary over time. Users should verify actual device performance in their specific applications.

PEC12R - 12 mm Incremental Encoder

BOURNS®

Product Dimensions

PEC12R-4xxxF-Nxxxx (Horizontal Mount - Axial PC Pin/No Bushing, No Switch)



PEC12R-4xxxF-Sxxxx (Horizontal Mount - Axial PC Pin/No Bushing, Push Momentary Switch)



L	15.0 (.591)	17.5 (.688)	20.0 (.787)	22.5 (.886)	25.0 (.984)	30.0 (1.181)
LB	2.0 (.079)	5.0 (.197)	5.0 (.197)	5.0 (.197)	5.0 (.197)	5.0 (.197)
F	5.0 (.197)	5.0 (.197)	7.0 (.276)	7.0 (.276)	12.0 (.472)	12.0 (.472)

DIMENSIONS: $\frac{\text{MM}}{(\text{INCHES})}$

TOLERANCE: $\frac{<10}{(<.400)} = \pm 0.3$
 $\frac{}{(<.400)} = (\pm 0.12)$

$\frac{\geq 10}{(\geq .400)} = \pm 0.5$
 $\frac{}{(\geq .400)} = (\pm 0.20)$

BOURNS®

Asia-Pacific:
 Tel: +886-2 2562-4117
 Fax: +886-2 2562-4116

EMEA:
 Tel: +36 88 520 390
 Fax: +36 88 520 211

The Americas:
 Tel: +1-951 781-5500
 Fax: +1-951 781-5700

www.bourns.com

REV. 04/15

Specifications are subject to change without notice.

The device characteristics and parameters in this data sheet can and do vary in different applications and actual device performance may vary over time.

Users should verify actual device performance in their specific applications.

Компания «Life Electronics» занимается поставками электронных компонентов импортного и отечественного производства от производителей и со складов крупных дистрибьюторов Европы, Америки и Азии.

С конца 2013 года компания активно расширяет линейку поставок компонентов по направлению коаксиальный кабель, кварцевые генераторы и конденсаторы (керамические, пленочные, электролитические), за счёт заключения дистрибьюторских договоров

Мы предлагаем:

- Конкурентоспособные цены и скидки постоянным клиентам.
- Специальные условия для постоянных клиентов.
- Подбор аналогов.
- Поставку компонентов в любых объемах, удовлетворяющих вашим потребностям.
- Приемлемые сроки поставки, возможна ускоренная поставка.
- Доставку товара в любую точку России и стран СНГ.
- Комплексную поставку.
- Работу по проектам и поставку образцов.
- Формирование склада под заказчика.
- Сертификаты соответствия на поставляемую продукцию (по желанию клиента).
- Тестирование поставляемой продукции.
- Поставку компонентов, требующих военную и космическую приемку.
- Входной контроль качества.
- Наличие сертификата ISO.

В составе нашей компании организован Конструкторский отдел, призванный помогать разработчикам, и инженерам.

Конструкторский отдел помогает осуществить:

- Регистрацию проекта у производителя компонентов.
- Техническую поддержку проекта.
- Защиту от снятия компонента с производства.
- Оценку стоимости проекта по компонентам.
- Изготовление тестовой платы монтаж и пусконаладочные работы.



Тел: +7 (812) 336 43 04 (многоканальный)

Email: org@lifeelectronics.ru