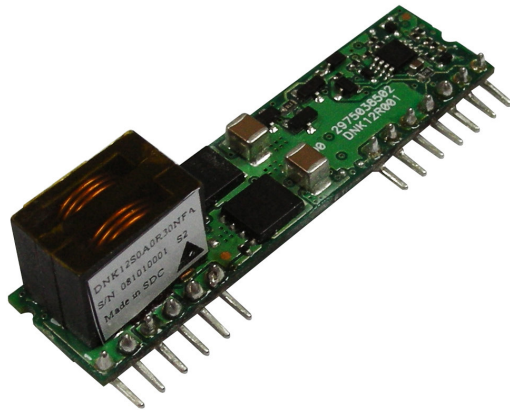


# DELPHI SERIES



## FEATURES

- ♦ High efficiency: 95% @ 12Vin, 5V/30A out (SIP)
- ♦ Small size and low profile: 50.8x12.7x14.0 mm (2.00"x0.50"x0.55")
- ♦ Standard footprint
- ♦ Pre-bias startup
- ♦ Output voltage tracking
- ♦ No minimum load required
- ♦ Voltage and resistor-based trim
- ♦ Output voltage programmable from 0.8Vdc to 5.5Vdc via external resistor
- ♦ Fixed frequency operation
- ♦ Input UVLO, Output OTP, OCP
- ♦ Remote ON/OFF
- ♦ Remote sense
- ♦ Current sharing (optional)
- ♦ ISO 9000, TL 9000, ISO 14001 certified manufacturing facility
- ♦ UL/cUL 60950-1 (US & Canada) recognized

## Delphi Series DNK12, Non-Isolated, Point of Load DC/DC Power Modules: 6~14Vin, 0.8V~5.5V/30Aout

The Delphi series DNK12, 6V~14V input, single output, non-isolated point of load DC/DC converters are the latest offering from a world leader in power systems technology and manufacturing -- Delta Electronics, Inc. The DNK12 series provides a programmable output voltage from 0.8V to 5.5V by using an external resistor. The DNK converters have flexible and programmable tracking and sequencing features to enable a variety of startup voltages as well as sequencing and tracking between power modules. This product family is available in a surface mount or SIP package and provides up to 30A of current in an industry standard footprint. With creative design technology and optimization of component placement, these converters possess outstanding electrical and thermal performance and extremely high reliability under highly stressful operating conditions.

## APPLICATIONS

- ♦ Telecom / DataCom
- ♦ Distributed power architectures
- ♦ Servers and workstations
- ♦ LAN / WAN applications
- ♦ Data processing applications

DATASHEET  
DS\_DNK12SIP\_09062016

# TECHNICAL SPECIFICATIONS

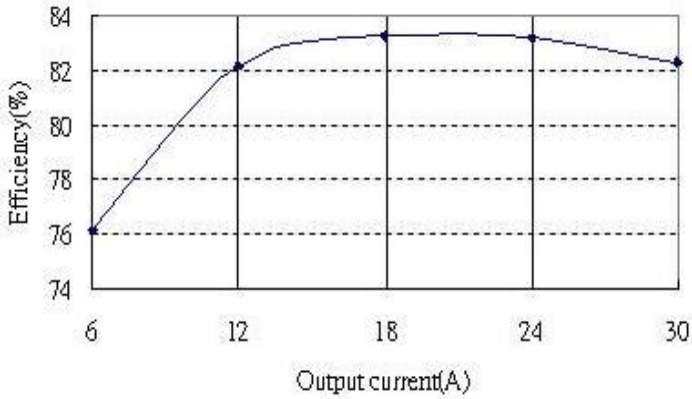
T<sub>A</sub> = 25°C, airflow rate = 300 LFM, V<sub>in</sub> = 10Vdc and 14Vdc, nominal V<sub>out</sub> unless otherwise noted.

PARAMETER	NOTES and CONDITIONS	DNK12S0A0R30			
		Min.	Typ.	Max.	Units
<b>ABSOLUTE MAXIMUM RATINGS</b>					
Input Voltage (Continuous)		0		15	Vdc
Tracking Voltage		0		V <sub>in,max</sub>	Vdc
Operating Ambient Temperature		-40		85	°C
Storage Temperature		-55		125	°C
<b>INPUT CHARACTERISTICS</b>					
Operating Input Voltage	V <sub>o</sub> ≤ 3.3V	6	12	14	V
	V <sub>o</sub> > 3.3V	8.3	12	14	V
Input Under-Voltage Lockout					
Turn-On Voltage Threshold			5.2		V
Turn-Off Voltage Threshold			4.8		V
Maximum Input Current	V <sub>in</sub> = V <sub>in,min</sub> to V <sub>in,max</sub> , I <sub>o</sub> = I <sub>o,max</sub>			27	A
No-Load Input Current			150		mA
Off Converter Input Current	V <sub>in</sub> = 12V		25	40	mA
Inrush Transient	V <sub>in</sub> = 10.2~13.8V, I <sub>o</sub> = I <sub>o,min</sub> to I <sub>o,max</sub>			1	A°S
Recommended Input Fuse			50		A
<b>OUTPUT CHARACTERISTICS</b>					
Output Voltage Set Point	With a 1% trim resistor	-1.5	V <sub>o,set</sub>	+1.5	% V <sub>o,set</sub>
Output Voltage Adjustable Range		0.8		5.5	V
Over Load	I <sub>o</sub> = I <sub>o,min</sub> to I <sub>o,max</sub>	-0.4		0.4	% V <sub>o,set</sub>
Total Output Voltage Range	Over sample load, line and temperature	-3.0		+3.0	% V <sub>o,set</sub>
Output Voltage Ripple and Noise	5Hz to 20MHz bandwidth with 0.01uF//0.1uF//10uF ceramic				
Peak-to-Peak	V <sub>o</sub> ≤ 2.5V, I <sub>o</sub> = I <sub>o,max</sub>		25	50	mV
	V <sub>o</sub> = 3.3V, I <sub>o</sub> = I <sub>o,max</sub>			75	mV
	V <sub>o</sub> = 5V, I <sub>o</sub> = I <sub>o,max</sub>			100	mV
RMS	V <sub>in</sub> = V <sub>in,min</sub> to V <sub>in,max</sub> , I <sub>o</sub> = I <sub>o,max</sub>		8		mV
Output Current Range		0		30	A
Output Voltage Over-shoot at Start-up	V <sub>in</sub> = 12V, Turn on			3	% V <sub>o,set</sub>
Output DC Current-Limit Inception	Hiccup mode		160		% I <sub>o</sub>
<b>DYNAMIC CHARACTERISTICS</b>					
Dynamic Load Response	10uF Tan & 1uF ceramic load cap, 1A/μs, 5V <sub>out</sub>				
Positive Step Change in Output Current	50% I <sub>o,max</sub> to 100% I <sub>o,max</sub>			350	mV
Negative Step Change in Output Current	100% I <sub>o,max</sub> to 50% I <sub>o,max</sub>			350	mV
Setting Time to 10% of Peak Deviation			25		μs
Turn-On Transient	I <sub>o</sub> = I <sub>o,max</sub>				
Start-Up Time, From On/Off Control	V <sub>on/off</sub> , V <sub>o</sub> = 10% of V <sub>o,set</sub>		3		ms
Start-Up Time, From Input	V <sub>in</sub> = V <sub>in,min</sub> , V <sub>o</sub> = 10% of V <sub>o,set</sub>		3		ms
Output Voltage Rise Time	Time for V <sub>o</sub> to rise from 10% to 90% of V <sub>o,set</sub>		4		ms
Maximum Output Startup Capacitive Load	Full load; ESR ≥ 1mΩ			2000	μF
	Full load; ESR ≥ 10mΩ			10000	μF
<b>EFFICIENCY</b>					
V <sub>o</sub> = 0.8V	V <sub>in</sub> = 12V, I <sub>o</sub> = I <sub>o,max</sub>		82		%
V <sub>o</sub> = 1.2V	V <sub>in</sub> = 12V, I <sub>o</sub> = I <sub>o,max</sub>		85		%
V <sub>o</sub> = 1.5V	V <sub>in</sub> = 12V, I <sub>o</sub> = I <sub>o,max</sub>		89		%
V <sub>o</sub> = 1.8V	V <sub>in</sub> = 12V, I <sub>o</sub> = I <sub>o,max</sub>		90.5		%
V <sub>o</sub> = 2.5V	V <sub>in</sub> = 12V, I <sub>o</sub> = I <sub>o,max</sub>		93		%
V <sub>o</sub> = 3.3V	V <sub>in</sub> = 12V, I <sub>o</sub> = I <sub>o,max</sub>		94		%
V <sub>o</sub> = 5.0V	V <sub>in</sub> = 12V, I <sub>o</sub> = I <sub>o,max</sub>		95		%
<b>FEATURE CHARACTERISTICS</b>					
Switching Frequency			300		kHz
ON/OFF Control, (Negative logic)					
Logic Low Voltage	Module On, V <sub>on/off</sub>	-0.3		1.2	V
Logic High Voltage	Module Off, V <sub>on/off</sub>	3		V <sub>in,max</sub>	V
Logic Low Current	Module On, I <sub>on/off</sub>			10	uA
Logic High Current	Module Off, I <sub>on/off</sub>		0.2	1	mA
Tracking Slew Rate Capability	V <sub>in</sub> = V <sub>in,min</sub> to V <sub>in,max</sub> , I <sub>o</sub> = I <sub>o,min</sub> to I <sub>o,max</sub> , V <sub>seq</sub> < V <sub>o</sub>			2	V/msec
Tracking Delay Time	Delay from V <sub>in,min</sub> to application of tracking voltage	10			ms
Tracking Accuracy	Power-up, subject to 2V/mS		100	200	mV
	Power-down, subject to 1V/mS		200	400	mV
Remote Sense Range				0.5	V
<b>GENERAL SPECIFICATIONS</b>					
MTBF	I <sub>o</sub> = I <sub>o,max</sub> , T <sub>a</sub> = 25°C		5.42		M hours
Weight			10		grams
Over-Temperature Shutdown (Hot Spot)	Refer to Figure 43 for Hot spot location (12V <sub>in</sub> , 80% I <sub>o</sub> , 200LFM, Airflow from Pin1 to Pin13)		133		°C
Over-Temperature Shutdown (NTC Resistor)	Refer to Figure 43 for NTC resistor location		130		°C

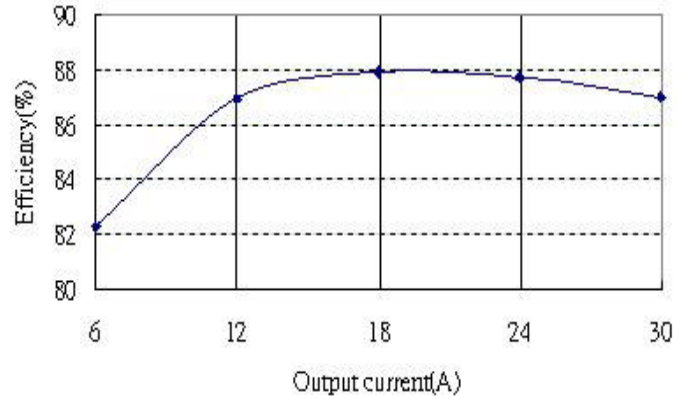
Note: Please attach thermocouple on NTC resistor to test OTP function, the hot spot's temperature is just for reference.



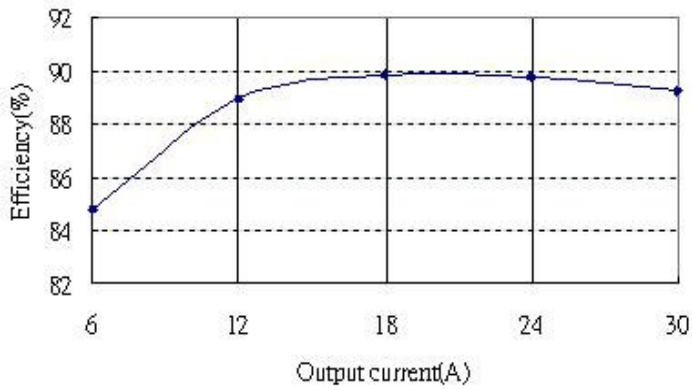
## ELECTRICAL CHARACTERISTICS CURVES



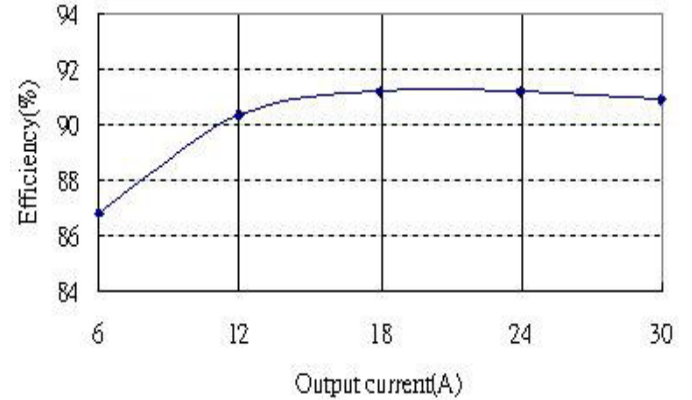
**Figure 1:** Converter efficiency vs. output current (0.8V output voltage)



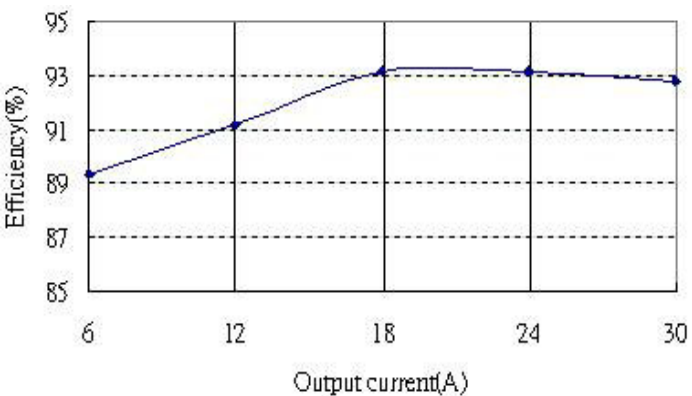
**Figure 2:** Converter efficiency vs. output current (1.2V output voltage)



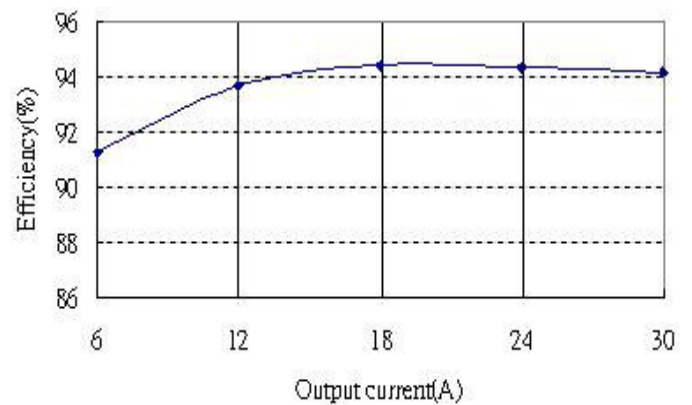
**Figure 3:** Converter efficiency vs. output current (1.5V output voltage)



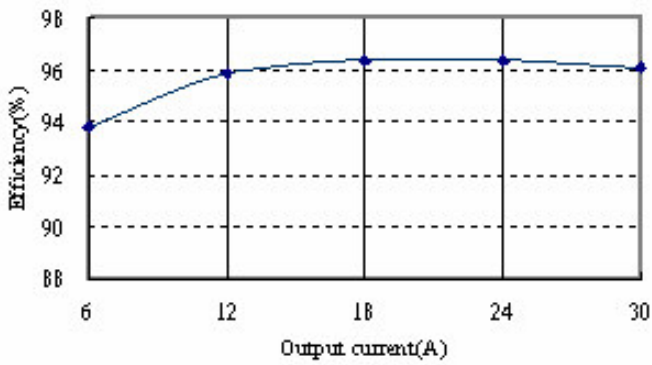
**Figure 4:** Converter efficiency vs. output current (1.8V output voltage)



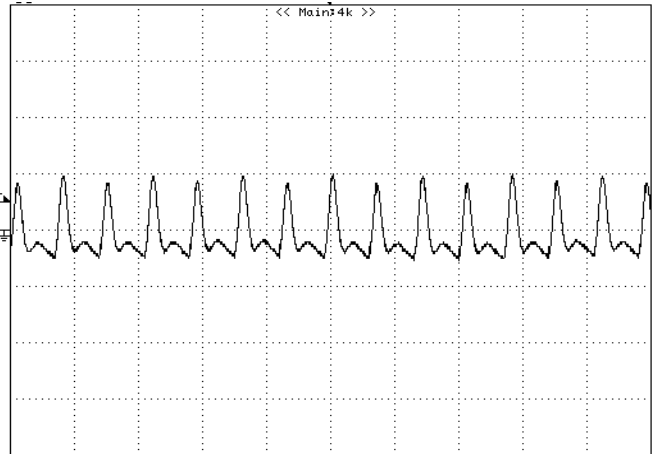
**Figure 5:** Converter efficiency vs. output current (2.5V output voltage)



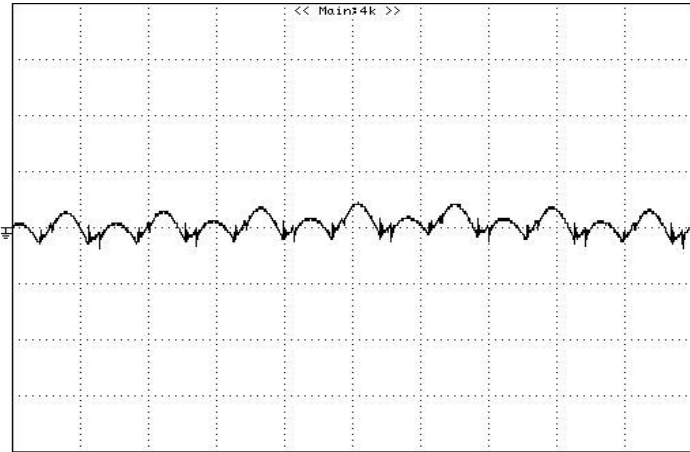
**Figure 6:** Converter efficiency vs. output current (3.3V output voltage)



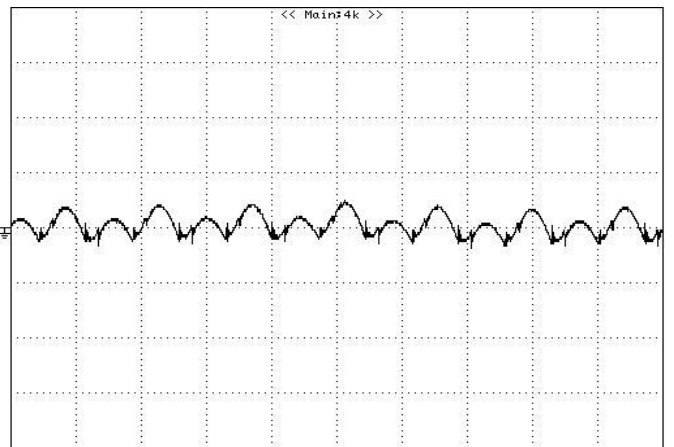
**Figure 7:** Converter efficiency vs. output current  
(5V output voltage)



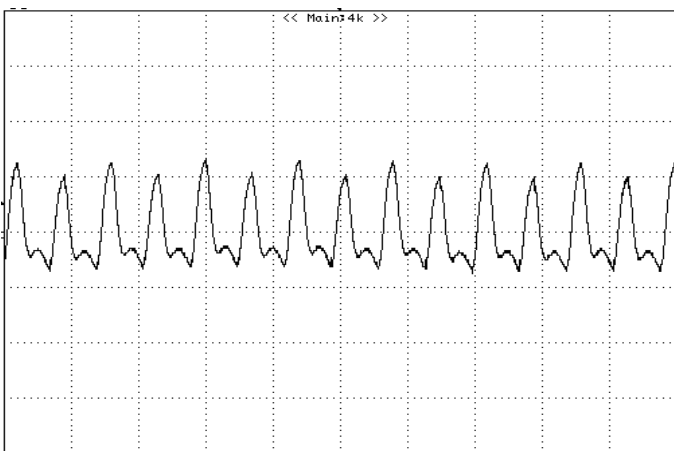
**Figure 8:** Output ripple & noise at 12Vin, 0.8V/30A out  
20mV/div, 2uS/div



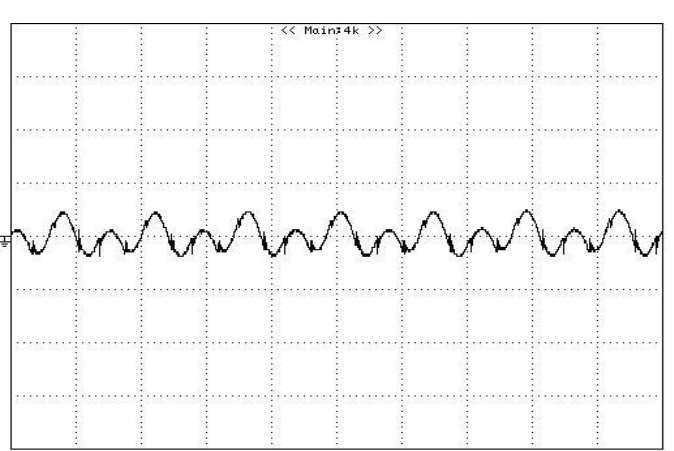
**Figure 9:** Output ripple & noise at 12Vin, 1.2V/30A out  
20mV/div, 2uS/div



**Figure 10:** Output ripple & noise at 12Vin, 1.5V/30A out  
20mV/div, 2uS/div

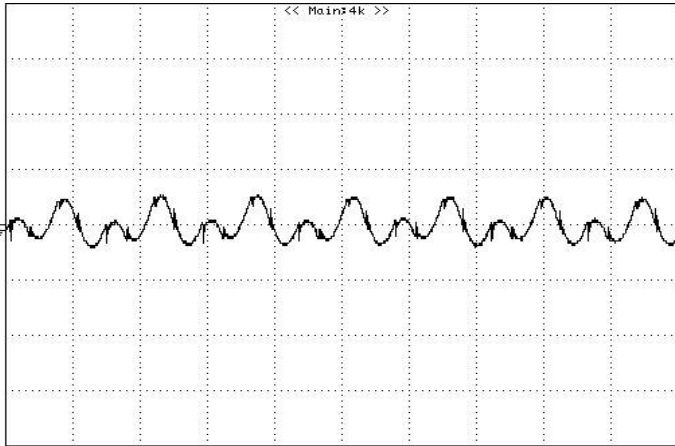


**Figure 11:** Output ripple & noise at 12Vin, 1.8V/30A out  
20mV/div, 2uS/div

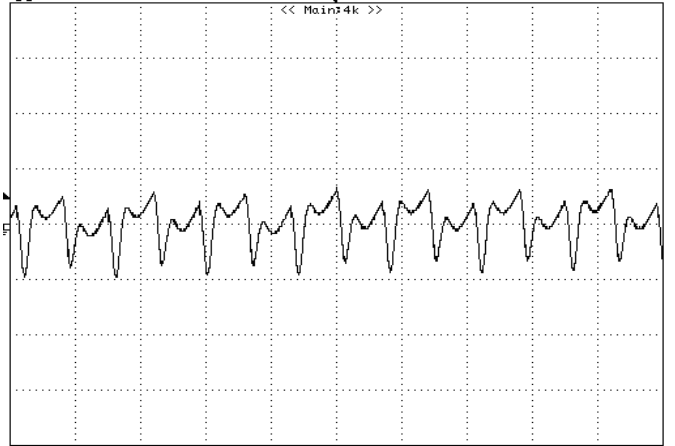


**Figure 12:** Output ripple & noise at 12Vin, 2.5V/30A out  
20mV/div, 2uS/div

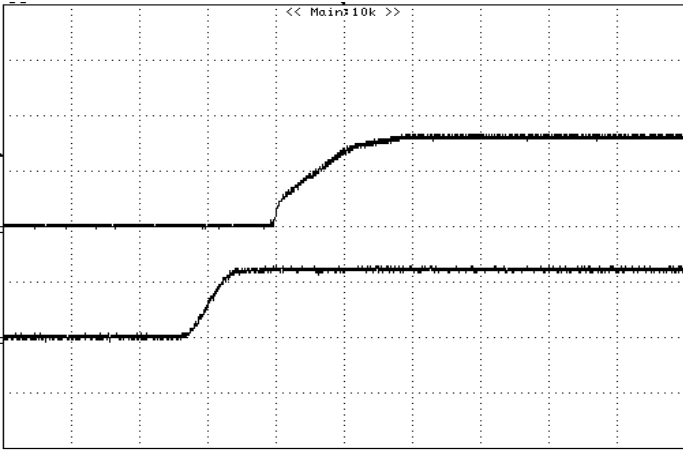




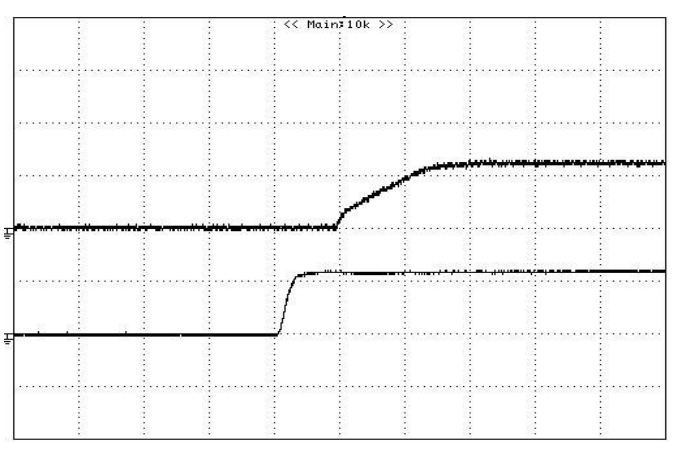
**Figure 13:** Output ripple & noise at 12Vin, 3.3V/30A out  
20mV/div, 2uS/div



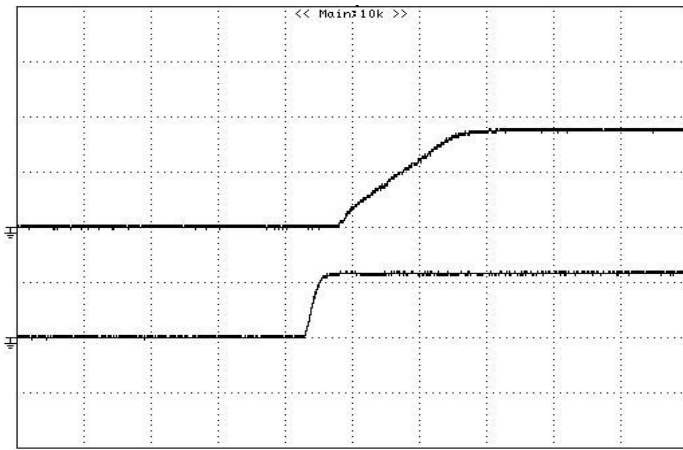
**Figure 14:** Output ripple & noise at 12Vin, 5V/30A out  
20mV/div, 2uS/div



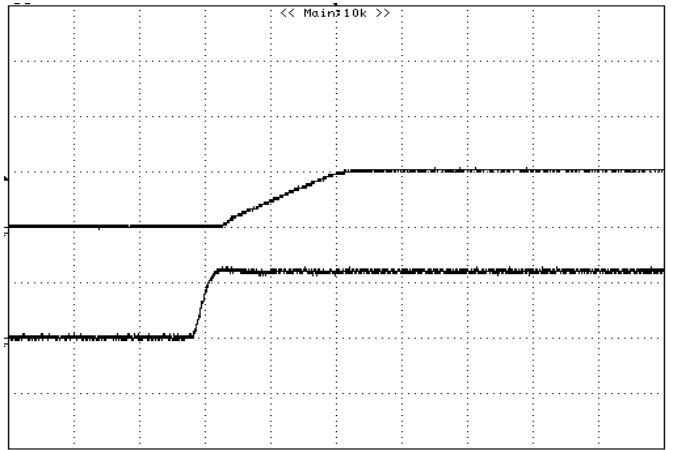
**Figure 15:** Turn on delay time at 12vin, 0.8V/30A out  
Top: 0.5V/div, 2ms/div, Bottom: 10V/div, 2ms/div



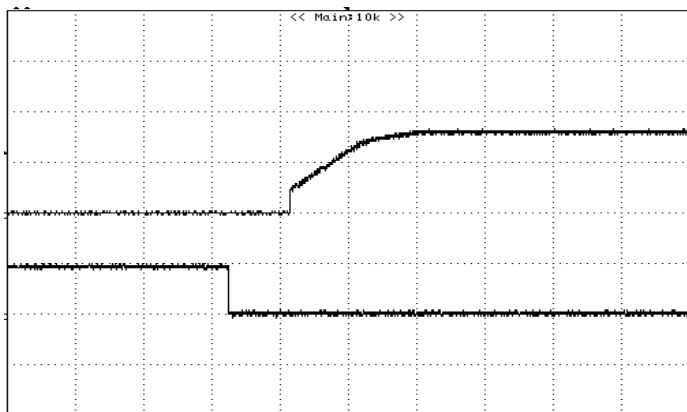
**Figure 16:** Turn on delay time at 12vin, 1.2V/30A out  
Top: 1V/div, 2ms/div, Bottom: 10V/div, 2ms/div



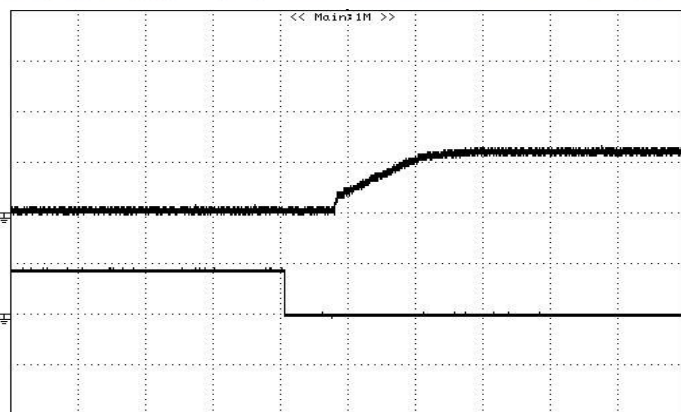
**Figure 17:** Turn on delay time at 12vin, 3.3V/30A out  
Top: 2V/div, 2ms/div, Bottom: 10V/div, 2ms/div



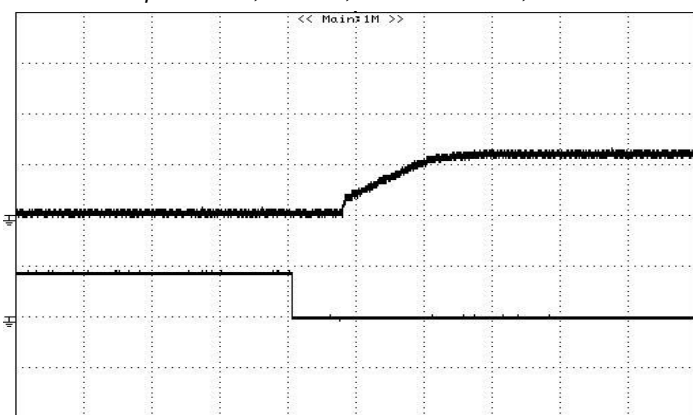
**Figure 18:** Turn on delay time at 12vin, 5V/30A out  
Top: 5V/div, 2ms/div, Bottom: 10V/div, 2ms/div



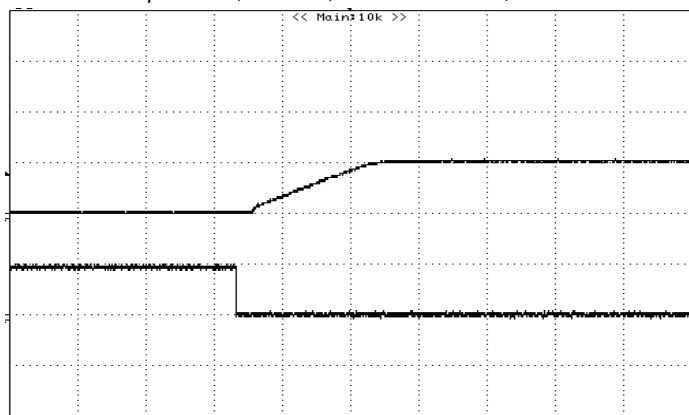
**Figure 19:** Turn on delay time at Remote On/Off, 0.8V/30A out  
Top: 0.5V/div, 2ms/div, Bottom: 10V/div, 2ms/div



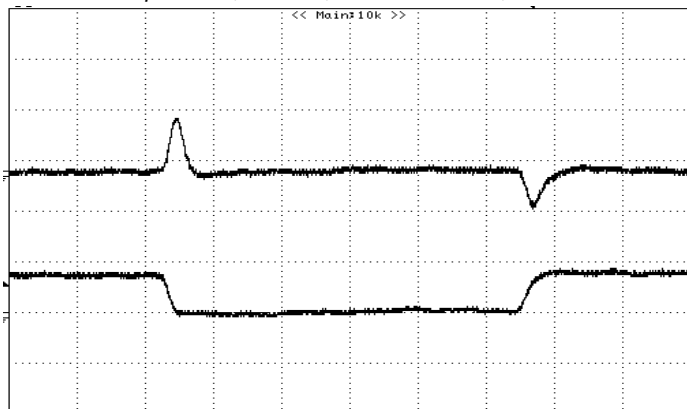
**Figure 20:** Turn on delay time at Remote On/Off, 1.2V/30A out  
Top: 1V/div, 2ms/div, Bottom: 10V/div, 2ms/div



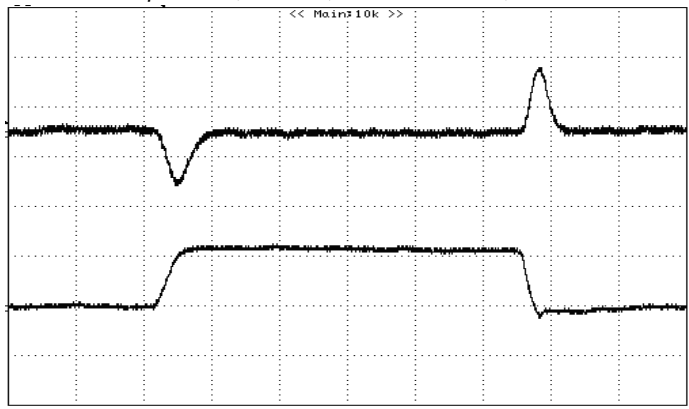
**Figure 21:** Turn on delay time at Remote On/Off, 3.3V/30A out  
Top: 2V/div, 2ms/div, Bottom: 10V/div, 2ms/div



**Figure 22:** Turn on delay time at Remote On/Off, 5V/30A out  
Top: 5V/div, 2ms/div, Bottom: 10V/div, 2ms/div



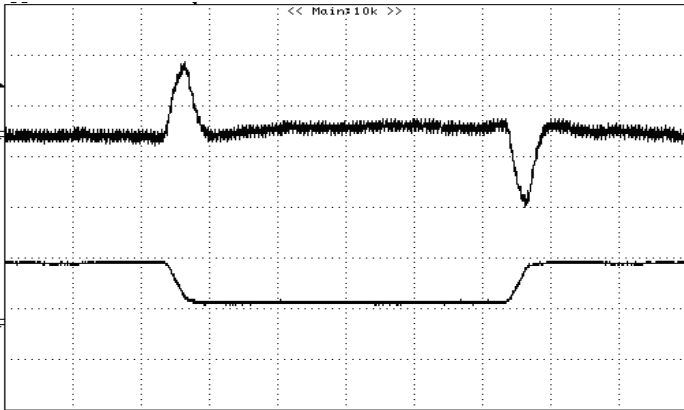
**Figure 23:** Typical transient response to step load change at 1A/μS from 25% to 75% of  $I_o$ , max at 12Vin, 0.8V out  
( $C_{out} = 1\mu F$  ceramic, 10μF tantalum)  
Top: 100mV/div, 50μS/div, Bottom: 20A/div, 50μS/div



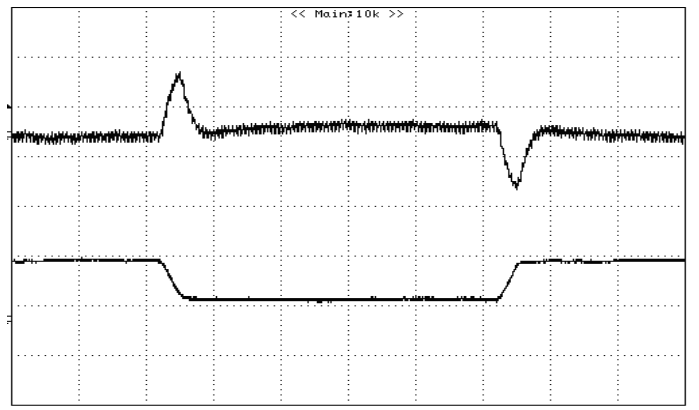
**Figure 24:** Typical transient response to step load change at 1A/μS from 25% to 75% of  $I_o$ , max at 12Vin, 1.2V out  
( $C_{out} = 1\mu F$  ceramic, 10μF tantalum)  
Top: 100mV/div, 50μS/div, Bottom: 20A/div, 50μS/div



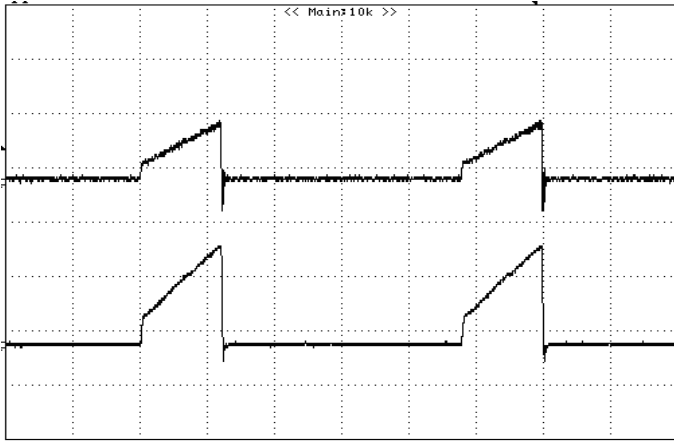
# ELECTRICAL CHARACTERISTICS CURVES



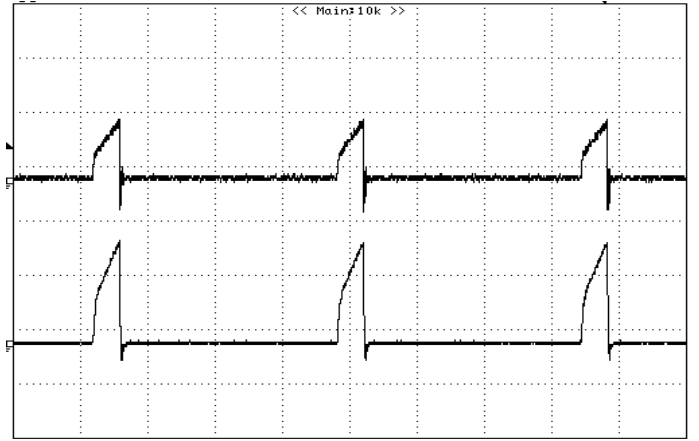
**Figure 25:** Typical transient response to step load change at  $5A/\mu S$  from 25% to 75% of  $I_o$ , max at 12Vin, 3.3V out (Cout = 1uF ceramic, 10uF tantalum)  
Top: 100mV/div, 50uS/div, Bottom: 20A/div, 50uS/div



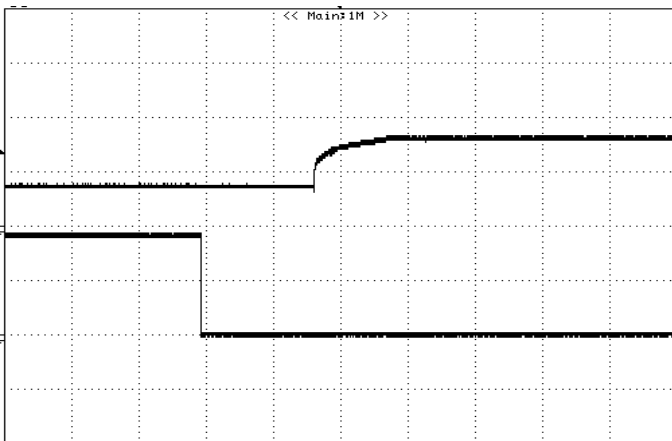
**Figure 26:** Typical transient response to step load change at  $5A/\mu S$  from 25% to 75% of  $I_o$ , max at 12Vin, 5V out (Cout = 1uF ceramic, 10uF tantalum)  
Top: 100mV/div, 50uS/div, Bottom: 20A/div, 50uS/div



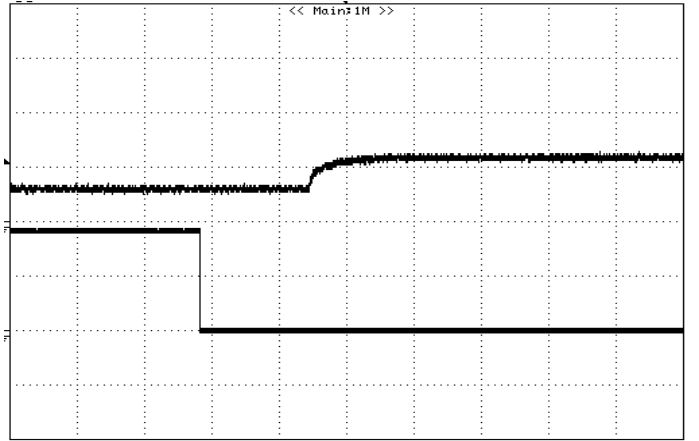
**Figure 27:** Output short circuit current 12Vin, 1.2Vout  
Top: 1V/div, 5ms/div, Bottom: 20A/div, 5ms/div



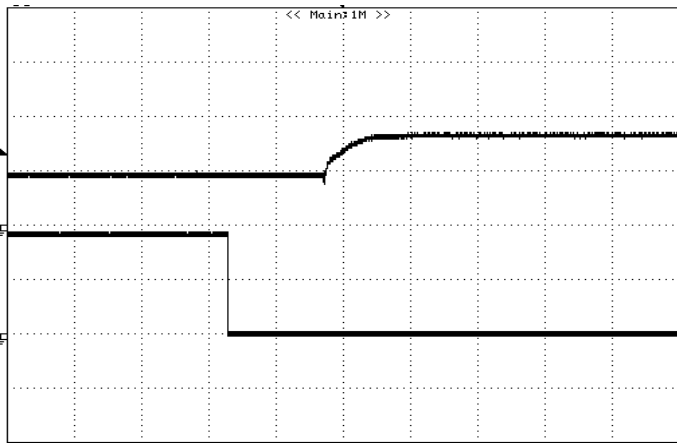
**Figure 28:** Output short circuit current 12Vin, 3.3Vout  
Top: 1V/div, 5ms/div, Bottom: 20A/div, 5ms/div



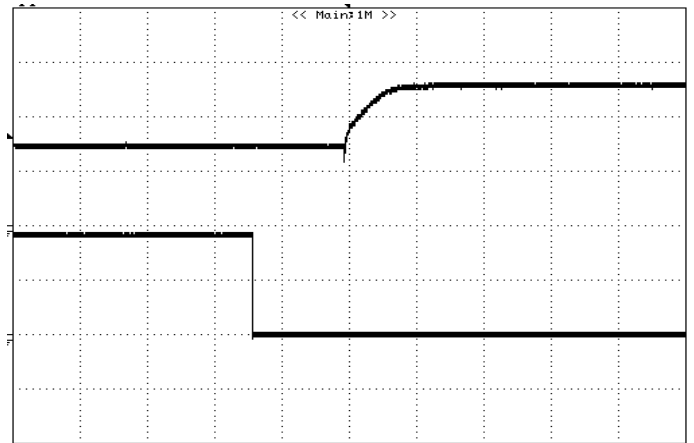
**Figure 29:** Turn on with Prebias 12Vin, 0.8V/0A out, Vbias = 0.5Vdc  
Top: 0.5V/div, 2ms/div, Bottom: 5V/div, 2ms/div



**Figure 30:** Turn on with Prebias 12Vin, 1.2V/0A out, Vbias = 0.79Vdc  
Top: 1V/div, 2ms/div, Bottom: 5V/div, 2ms/div



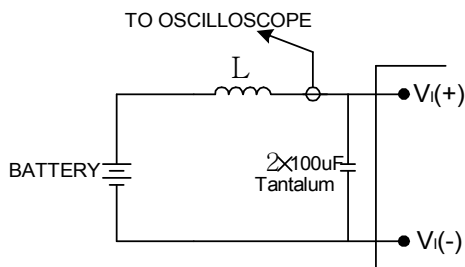
**Figure 31:** Turn on with Prebias 12Vin, 3.3V/0A out, Vbias = 2.2Vdc  
Top: 2V/div, 2ms/div, Bottom: 5V/div, 2ms/div



**Figure 32:** Turn on with Prebias 12Vin, 5V/0A out, Vbias = 3.3Vdc  
Top: 2V/div, 2ms/div, Bottom: 5V/div, 2ms/div

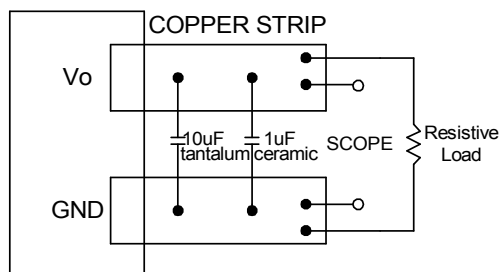


## TEST CONFIGURATIONS



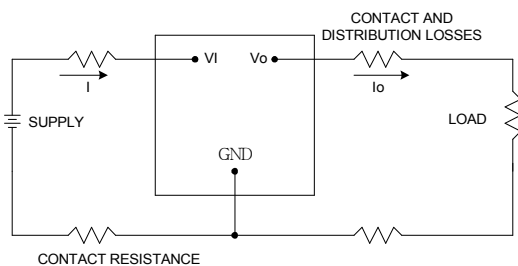
Note: Input reflected-ripple current is measured with a simulated source inductance. Current is measured at the input of the module.

**Figure 33:** Input reflected-ripple test setup



Note: Use a 10µF tantalum and 1µF capacitor. Scope measurement should be made using a BNC connector.

**Figure 34:** Peak-peak output noise and startup transient measurement test setup



**Figure 35:** Output voltage and efficiency measurement test setup

Note: All measurements are taken at the module terminals. When the module is not soldered (via socket), place Kelvin connections at module terminals to avoid measurement errors due to contact resistance.

$$\eta = \left( \frac{V_o \times I_o}{V_i \times I_i} \right) \times 100 \quad \%$$

## DESIGN CONSIDERATIONS

### Safety Considerations

For safety-agency approval the power module must be installed in compliance with the spacing and separation requirements of the end-use safety agency standards.

For the converter output to be considered meeting the requirements of safety extra-low voltage (SELV), the input must meet SELV requirements. The power module has extra-low voltage (ELV) outputs when all inputs are ELV.

The input to these units is to be provided with a maximum 50A of glass type fast-acting fuse in the ungrounded lead.

### Input Source Impedance

The power module should be connected to a low ac-impedance input source. Highly inductive source impedances can affect the stability of the module. An input capacitance must be placed close to the modules input pins to filter ripple current and ensure module stability in the presence of inductive traces that supply the input voltage to the module.

## FEATURES DESCRIPTIONS

### Remote On/Off

The DNK series power modules have an On/Off pin for remote On/Off operation. Only negative On/Off logic option is available in the DNK series power modules.

For negative logic module, the On/Off pin is suggested to be pulled high with an external pull-up resistor (see figure 36). Negative logic On/Off signal turns the module OFF during logic high and turns the module ON during logic low. If the negative On/Off function is not used, leave the pin floating or tie to GND. (module will be On)

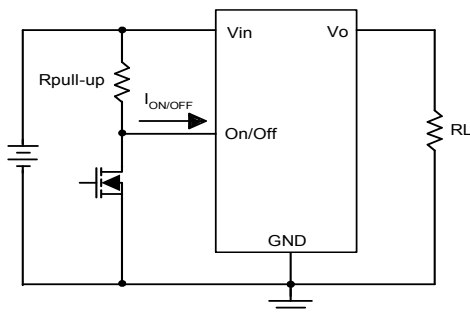


Figure 36: Negative remote On/Off implementation

### Over-Current Protection

To provide protection in an output over load fault condition, the unit is equipped with internal over-current protection. When the over-current protection is triggered, the unit enters hiccup mode. The units operate normally once the fault condition is removed.

### Over-Temperature Protection

The over-temperature protection consists of circuitry that provides protection from thermal damage. If the temperature exceeds the over-temperature threshold the module will shut down. The module will restart once the temperature is within specification

### Remote Sense

The DNK provide Vo remote sensing to achieve proper regulation at the load points and reduce effects of distribution losses on output line. In the event of an open remote sense line, the module shall maintain local sense regulation through an internal resistor.

## FEATURES DESCRIPTIONS (CON.)

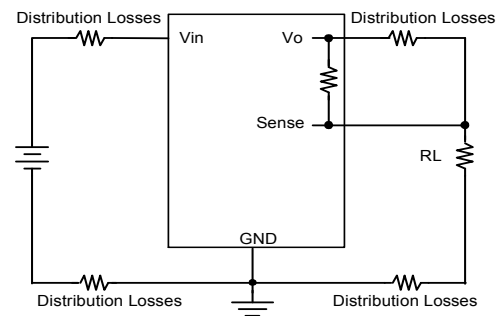


Figure 37: Effective circuit configuration for remote sense operation

### Output Voltage Programming

The output voltage of the DNK can be programmed to any voltage between 0.8Vdc and 5.5Vdc by connecting one resistor (shown as Rtrim in Figure 38) between the TRIM and GND pins of the module. Without this external resistor, the output voltage of the module is 0.8 Vdc. To calculate the value of the resistor Rtrim for a particular output voltage Vo, please use the following equation:

$$R_{trim} := \left( \frac{1200}{V_o - 0.80} - 100 \right) \cdot \Omega$$

Rtrim is the external resistor in  $\Omega$   
Vo is the desired output voltage

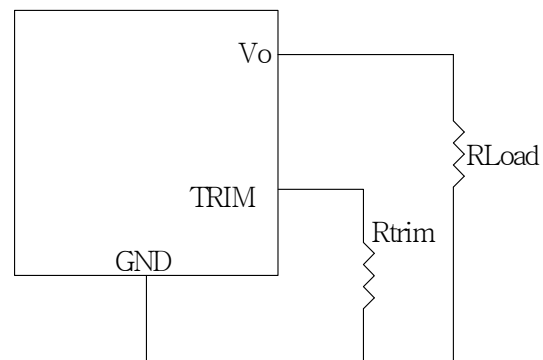


Figure 38: Circuit configuration for programming output voltage using an external resist

## FEATURES DESCRIPTIONS (CON.)

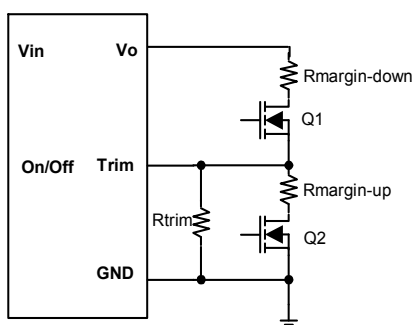
Table 1 provides Rtrim values required for some common output voltages. By using a 0.5% tolerance trim resistor, set point tolerance of  $\pm 1.5\%$  can be achieved as specified in the electrical specification.

**Table 1**

VO (V)	Rtrim ( $\Omega$ )
0.8	Open
1.2	2900
1.5	1614
1.8	1100
2.5	606
3.3	380
5.0	185.7

## Voltage Margining

Output voltage margining can be implemented in the DNK modules by connecting a resistor,  $R_{margin-up}$ , from the Trim pin to the ground pin for margining-up the output voltage and by connecting a resistor,  $R_{margin-down}$ , from the Trim pin to the output pin for margining-down. Figure 39 shows the circuit configuration for output voltage margining. If unused, leave the trim pin unconnected. A calculation tool is available from the evaluation procedure which computes the values of  $R_{margin-up}$  and  $R_{margin-down}$  for a specific output voltage and margin percentage.



**Figure 39:** Circuit configuration for output voltage margining

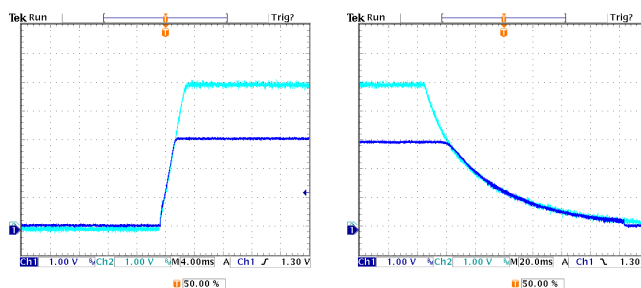
## FEATURES DESCRIPTIONS (CON.)

### Voltage Tracking

The DNK family was designed for applications that have output voltage tracking requirements during power-up and power-down. The devices have a TRACK pin to implement three types of tracking method: sequential, simultaneous and ratio-metric. TRACK simplifies the task of supply voltage tracking in a power system by enabling modules to track each other, or any external voltage, during power-up and power-down.

By connecting multiple modules together, customers can get multiple modules to track their output voltages to the voltage applied on the TRACK pin.

The DNK family has option code A for TRACK function. The output voltage Track characteristic can be achieved when the output voltage of PS2 follows the output voltage of PS1 on a volt-to-volt basis.



**Figure 40:** Simultaneous tracking

Simultaneous tracking (Figure 40) is implemented by using a voltage divider around the TRACK pin. The objective is to minimize the voltage difference between the power supply outputs during power up and down.

For type A (DNX0A0XXXX **A**), the simultaneous tracking can be accomplished by connecting  $VO_{PS1}$  to the TRACK pin of PS2 where the voltage divider is inside the PS2.



## THERMAL CONSIDERATIONS

Thermal management is an important part of the system design. To ensure proper, reliable operation, sufficient cooling of the power module is needed over the entire temperature range of the module. Convection cooling is usually the dominant mode of heat transfer.

Hence, the choice of equipment to characterize the thermal performance of the power module is a wind tunnel.

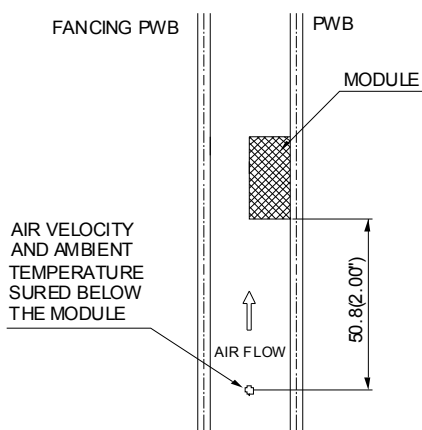
### Thermal Testing Setup

Delta's DC/DC power modules are characterized in heated vertical wind tunnels that simulate the thermal environments encountered in most electronics equipment. This type of equipment commonly uses vertically mounted circuit cards in cabinet racks in which the power modules are mounted.

The following figure shows the wind tunnel characterization setup. The power module is mounted on a test PWB and is vertically positioned within the wind tunnel. The height of this fan duct is constantly kept at 25.4mm (1").

### Thermal Derating

Heat can be removed by increasing airflow over the module. To enhance system reliability, the power module should always be operated below the maximum operating temperature. If the temperature exceeds the maximum module temperature, reliability of the unit may be affected.



Note: Wind Tunnel Test Setup Figure Dimensions are in millimeters and (Inches)

Figure 42: Wind tunnel test setup

## THERMAL CURVES

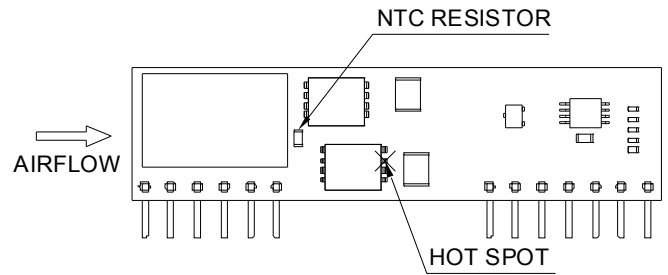


Figure 43: \* Hot spot & NTC resistor temperature measured points. The allowed maximum hot spot temperature is defined at 120 °C.

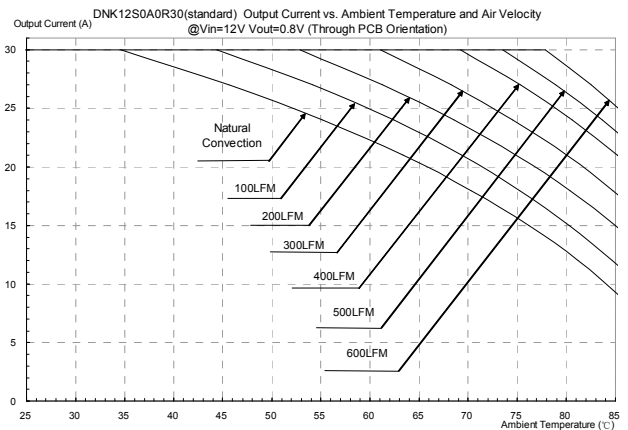


Figure 44: Output current vs. ambient temperature and air velocity @ Vin=12V, Vout=0.8V (Through PCB Orientation, Airflow from Pin1 to Pin13)

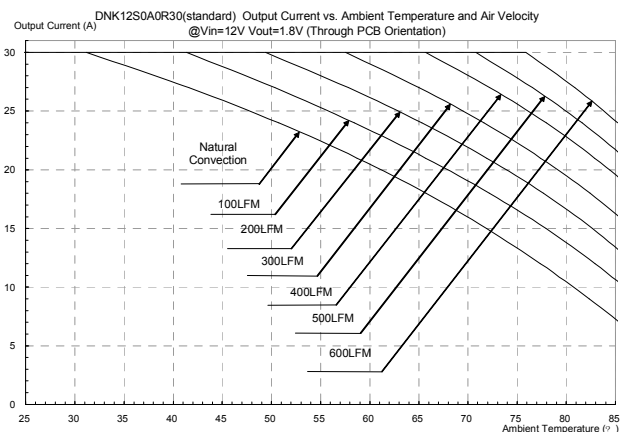
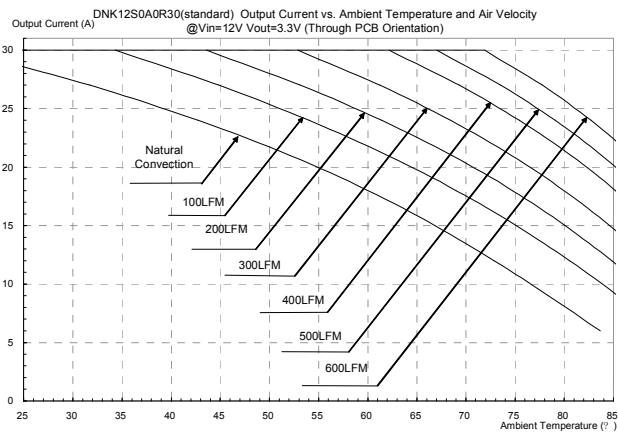


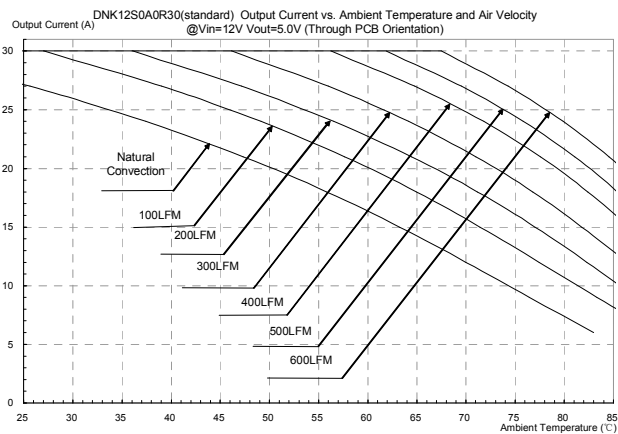
Figure 45: Output current vs. ambient temperature and air velocity @ Vin=12V, Vout=1.8V (Through PCB Orientation, Airflow from Pin1 to Pin13)



## THERMAL CURVES



**Figure 46:** Output current vs. ambient temperature and air velocity @ Vin=12V, Vout=3.3V (Through PCB Orientation, Airflow from Pin1 to Pin13)

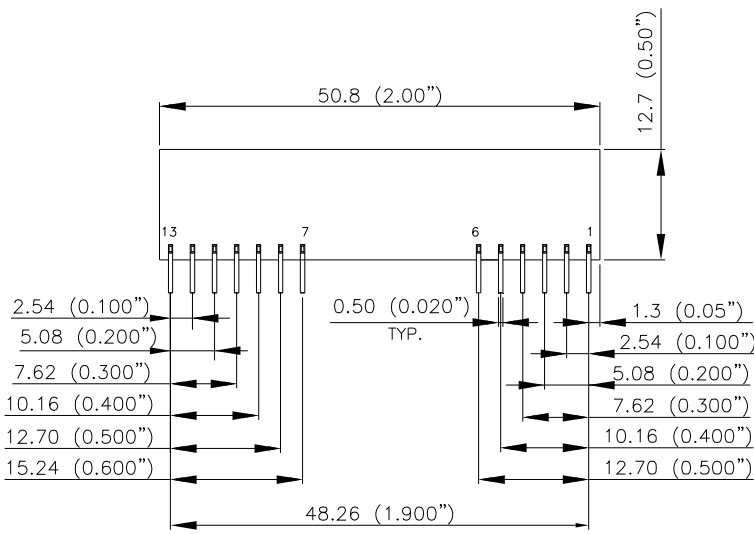


**Figure 47:** Output current vs. ambient temperature and air velocity @ Vin=12V, Vout=5.0V (Through PCB Orientation, Airflow from Pin1 to Pin13)

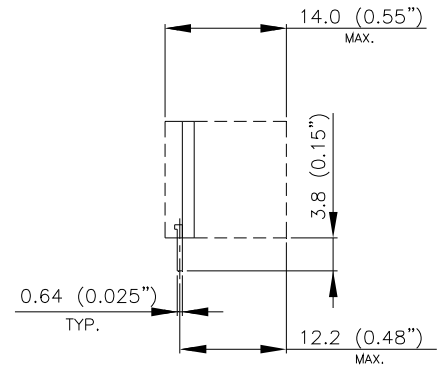




# MECHANICAL DRAWING



BACK VIEW



SIDE VIEW

PIN#	Function	PIN#	Function	PIN#	Function
1	Vo	6	GND	11	SEQ
2	Vo	7	SHARE *	12	TRIM
3	SENSE(+)	8	GND	13	ON/OFF
4	Vo	9	Vin		
5	GND	10	Vin		

\* Pin 7 is Optional

**NOTES:**

DIMENSIONS ARE IN MILLIMETERS AND (INCHES)

TOLERANCES: X.Xmm±0.5mm(X.XX in.±0.02 in.)

X.XXmm±0.25mm(X.XXX in.±0.010 in.)

Note: All pins are copper alloy with Matte-tin(Pb free) plated over Nickel underplating.



## PART NUMBERING SYSTEM

DNK	12	S	0A0	R	30	N	F	A
Product Family	Input Voltage	Number of Outputs	Output Voltage	Package Type	Output Current	On/Off Logic		Option Code
DNK - 30A	12 - 6.0V ~ 14V	S - Single	0A0 - Programmable	R - SIP	30 - 30A	N - Negative	F- RoHS 6/6 (Lead Free) Space - RoHs 5/6	A - Standard Function w/o current sharing B - with current sharing

## MODEL LIST

Model Name	Package	Input Voltage	Output Voltage	Output Current	Efficiency 12Vin, 5Vout @ full load
DNK12S0A0R30NFA	SIP	6.0V ~ 14Vdc	0.8V ~ 5.0Vdc	30A	95%
DNK12S0A0R30N A	SIP	6.0V ~ 14Vdc	0.8V ~ 5.0Vdc	30A	95%

Contact: [www.deltaww.com/dcdc](http://www.deltaww.com/dcdc)

Email: [dcdc@deltaww.com](mailto:dcdc@deltaww.com)

### USA:

Telephone:  
East Coast: 978-656-3993  
West Coast: 510-668-5100  
Fax: (978) 656 3964

### Europe:

Phone: +31-20-655-0967  
Fax: +31-20-655-0999

### Asia & the rest of world:

Telephone: +886 3 4526107ext 6220~6224  
Fax: +886 3 4513485

## WARRANTY

Delta offers a two (2) year limited warranty. Complete warranty information is listed on our web site or is available upon request from Delta.

Information furnished by Delta is believed to be accurate and reliable. However, no responsibility is assumed by Delta for its use, nor for any infringements of patents or other rights of third parties, which may result from its use. No license is granted by implication or otherwise under any patent or patent rights of Delta. Delta reserves the right to revise these specifications at any time, without notice.

Компания «Life Electronics» занимается поставками электронных компонентов импортного и отечественного производства от производителей и со складов крупных дистрибьюторов Европы, Америки и Азии.

С конца 2013 года компания активно расширяет линейку поставок компонентов по направлению коаксиальный кабель, кварцевые генераторы и конденсаторы (керамические, пленочные, электролитические), за счёт заключения дистрибьюторских договоров

Мы предлагаем:

- Конкурентоспособные цены и скидки постоянным клиентам.
- Специальные условия для постоянных клиентов.
- Подбор аналогов.
- Поставку компонентов в любых объемах, удовлетворяющих вашим потребностям.
- Приемлемые сроки поставки, возможна ускоренная поставка.
- Доставку товара в любую точку России и стран СНГ.
- Комплексную поставку.
- Работу по проектам и поставку образцов.
- Формирование склада под заказчика.
- Сертификаты соответствия на поставляемую продукцию (по желанию клиента).
- Тестирование поставляемой продукции.
- Поставку компонентов, требующих военную и космическую приемку.
- Входной контроль качества.
- Наличие сертификата ISO.

В составе нашей компании организован Конструкторский отдел, призванный помогать разработчикам, и инженерам.

Конструкторский отдел помогает осуществить:

- Регистрацию проекта у производителя компонентов.
- Техническую поддержку проекта.
- Защиту от снятия компонента с производства.
- Оценку стоимости проекта по компонентам.
- Изготовление тестовой платы монтаж и пусконаладочные работы.



Тел: +7 (812) 336 43 04 (многоканальный)  
Email: [org@lifeelectronics.ru](mailto:org@lifeelectronics.ru)