



RF Power LDMOS Transistors

High Ruggedness N-Channel Enhancement-Mode Lateral MOSFETs

These high ruggedness devices are designed for use in high VSWR industrial, medical, broadcast, aerospace and mobile radio applications. Their unmatched input and output design supports frequency use from 1.8 to 400 MHz.

Typical Performance

Frequency (MHz)	Signal Type	V _{DD} (V)	P _{out} (W)	G _{ps} (dB)	η _D (%)
87.5–108 (1,2)	CW	60	1670 CW	23.8	83.5
230 (3)	Pulse (100 μsec, 20% Duty Cycle)	65	1800 Peak	24.4	75.7

Load Mismatch/Ruggedness

Frequency (MHz)	Signal Type	VSWR	P _{in} (W)	Test Voltage	Result
230 (3)	Pulse (100 μsec, 20% Duty Cycle)	> 65:1 at all Phase Angles	14 W Peak (3 dB Overdrive)	65	No Device Degradation

1. Measured in 87.5–108 MHz broadband reference circuit (page 5).
2. The values shown are the center band performance numbers across the indicated frequency range.
3. Measured in 230 MHz narrowband production test fixture (page 11).

Features

- Unmatched input and output allowing wide frequency range utilization
- Device can be used single-ended or in a push-pull configuration
- Qualified up to a maximum of 65 V_{DD} operation
- Characterized from 30 to 65 V for extended power range
- Lower thermal resistance package
- High breakdown voltage for enhanced reliability
- Suitable for linear application with appropriate biasing
- Integrated ESD protection with greater negative gate-source voltage range for improved Class C operation
- Included in NXP product longevity program with assured supply for a minimum of 15 years after launch

Typical Applications

- Industrial, scientific, medical (ISM)
 - Laser generation
 - Plasma generation
 - Particle accelerators
 - MRI, RF ablation and skin treatment
 - Industrial heating, welding and drying systems
- Radio and VHF TV broadcast
- Aerospace
 - HF communications
 - Radar

MRFX1K80N MRFX1K80GN

1.8–400 MHz, 1800 W CW, 65 V
 WIDEBAND
 RF POWER LDMOS TRANSISTORS

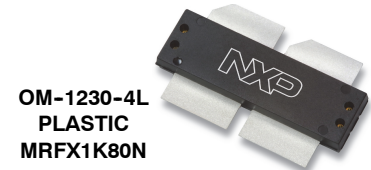

OM-1230-4L
 PLASTIC
 MRFX1K80N



OM-1230G-4L
 PLASTIC
 MRFX1K80GN

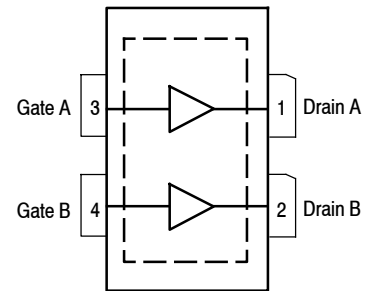

(Top View)

Note: Exposed backside of the package is the source terminal for the transistor.

Figure 1. Pin Connections



Table 1. Maximum Ratings

Rating	Symbol	Value	Unit
Drain-Source Voltage	V_{DSS}	-0.5, +179	Vdc
Gate-Source Voltage	V_{GS}	-6.0, +10	Vdc
Storage Temperature Range	T_{stg}	-65 to +150	°C
Case Operating Temperature Range	T_C	-40 to +150	°C
Operating Junction Temperature Range (1,2)	T_J	-40 to +225	°C
Total Device Dissipation @ $T_C = 25^\circ\text{C}$ Derate above 25°C	P_D	3333 16.7	W W/°C

Table 2. Thermal Characteristics

Characteristic	Symbol	Value (2,3)	Unit
Thermal Resistance, Junction to Case CW: Case Temperature 112°C, 1800 W CW, 65 Vdc, $I_{DQ(A+B)} = 150$ mA, 98 MHz	$R_{\theta JC}$	0.06	°C/W
Thermal Impedance, Junction to Case Pulse: Case Temperature 77°C, 1800 W Peak, 100 μsec Pulse Width, 20% Duty Cycle, 65 Vdc, $I_{DQ(A+B)} = 100$ mA, 230 MHz	$Z_{\theta JC}$	0.009	°C/W

Table 3. ESD Protection Characteristics

Test Methodology	Class
Human Body Model (per JESD22-A114)	2, passes 2500 V
Charge Device Model (per JESD22-C101)	C3, passes 1200 V

Table 4. Moisture Sensitivity Level

Test Methodology	Rating	Package Peak Temperature	Unit
Per JESD22-A113, IPC/JEDEC J-STD-020	3	260	°C

Table 5. Electrical Characteristics ($T_A = 25^\circ\text{C}$ unless otherwise noted)

Characteristic	Symbol	Min	Typ	Max	Unit
----------------	--------	-----	-----	-----	------

Off Characteristics (4)

Gate-Source Leakage Current ($V_{GS} = 5$ Vdc, $V_{DS} = 0$ Vdc)	I_{GSS}	—	—	1	μAdc
Drain-Source Breakdown Voltage ($V_{GS} = 0$ Vdc, $I_D = 100$ mAdc)	$V_{(BR)DSS}$	179	193	—	Vdc
Zero Gate Voltage Drain Leakage Current ($V_{DS} = 65$ Vdc, $V_{GS} = 0$ Vdc)	I_{DSS}	—	—	10	μAdc
Zero Gate Voltage Drain Leakage Current ($V_{DS} = 179$ Vdc, $V_{GS} = 0$ Vdc)	I_{DSS}	—	—	100	mAdc

On Characteristics

Gate Threshold Voltage (4) ($V_{DS} = 10$ Vdc, $I_D = 740$ μAdc)	$V_{GS(th)}$	2.1	2.5	2.9	Vdc
Gate Quiescent Voltage ($V_{DD} = 65$ Vdc, $I_{DQ(A+B)} = 100$ mAdc, Measured in Functional Test)	$V_{GS(Q)}$	2.5	2.9	3.3	Vdc
Drain-Source On-Voltage (4) ($V_{GS} = 10$ Vdc, $I_D = 2.76$ Adc)	$V_{DS(on)}$	—	0.21	—	Vdc
Forward Transconductance (4) ($V_{DS} = 10$ Vdc, $I_D = 43$ Adc)	g_{fs}	—	44.7	—	S

1. Continuous use at maximum temperature will affect MTF.
2. MTF calculator available at <http://www.nxp.com/RF/calculators>.
3. Refer to AN1955, *Thermal Measurement Methodology of RF Power Amplifiers*. Go to <http://www.nxp.com/RF> and search for AN1955.
4. Each side of device measured separately.

(continued)

Table 5. Electrical Characteristics ($T_A = 25^\circ\text{C}$ unless otherwise noted) (continued)

Characteristic	Symbol	Min	Typ	Max	Unit
Dynamic Characteristics ⁽¹⁾					
Reverse Transfer Capacitance ($V_{DS} = 65\text{ Vdc} \pm 30\text{ mV(rms)ac}$ @ 1 MHz, $V_{GS} = 0\text{ Vdc}$)	C_{rss}	—	5.6	—	pF
Output Capacitance ($V_{DS} = 65\text{ Vdc} \pm 30\text{ mV(rms)ac}$ @ 1 MHz, $V_{GS} = 0\text{ Vdc}$)	C_{oss}	—	216	—	pF
Input Capacitance ($V_{DS} = 65\text{ Vdc}$, $V_{GS} = 0\text{ Vdc} \pm 30\text{ mV(rms)ac}$ @ 1 MHz)	C_{iss}	—	765	—	pF

Functional Tests (In NXP Narrowband Production Test Fixture, 50 ohm system) $V_{DD} = 65\text{ Vdc}$, $I_{DQ(A+B)} = 100\text{ mA}$, $P_{out} = 1800\text{ W Peak}$ (360 W Avg.), $f = 230\text{ MHz}$, 100 μsec Pulse Width, 20% Duty Cycle

Power Gain	G_{ps}	23.0	24.4	26.0	dB
Drain Efficiency	η_D	71.0	75.7	—	%
Input Return Loss	IRL	—	-16	-9	dB

Table 6. Load Mismatch/Ruggedness (In NXP Narrowband Production Test Fixture, 50 ohm system) $I_{DQ(A+B)} = 100\text{ mA}$

Frequency (MHz)	Signal Type	VSWR	P_{in} (W)	Test Voltage, V_{DD}	Result
230	Pulse (100 μsec , 20% Duty Cycle)	> 65:1 at all Phase Angles	14 W Peak (3 dB Overdrive)	65	No Device Degradation

Table 7. Ordering Information

Device	Tape and Reel Information	Package
MRFX1K80NR5	R5 Suffix = 50 Units, 56 mm Tape Width, 13-Reel	OM-1230-4L
MRFX1K80G NR5		OM-1230G-4L

1. Each side of device measured separately.

TYPICAL CHARACTERISTICS

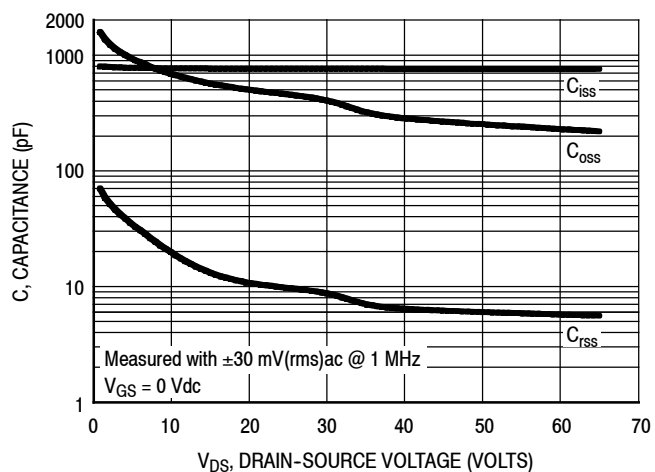

Note: Each side of device measured separately.

Figure 2. Capacitance versus Drain-Source Voltage

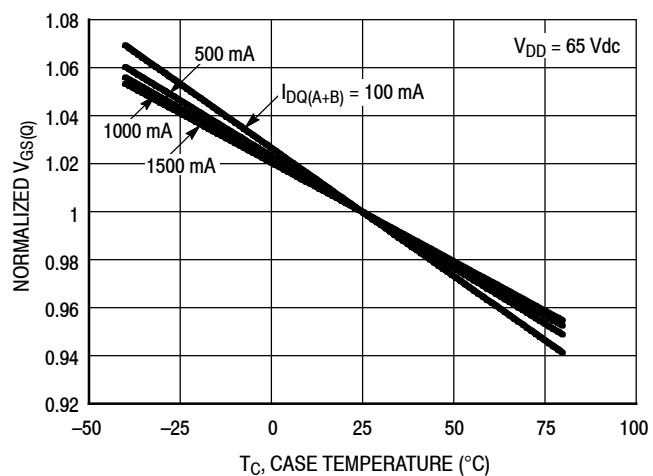

I_{DQ} (mA)	Slope (mV/°C)
100	-3.14
500	-2.88
1000	-2.75
1500	-2.65

Figure 3. Normalized V_{GS} versus Quiescent Current and Case Temperature

87.5–108 MHz BROADBAND REFERENCE CIRCUIT – 2.9" × 5.1" (7.3 cm × 13.0 cm)

Table 8. 87.5–108 MHz Broadband Performance (In NXP Reference Circuit, 50 ohm system)

$I_{DQ(A+B)} = 200 \text{ mA}$, $P_{in} = 7 \text{ W}$, CW

Frequency (MHz)	V _{DD} (V)	P _{out} (W)	G _{ps} (dB)	η _D (%)
87.5	60	1580	23.5	84.6
98	60	1670	23.8	83.5
108	60	1600	23.6	80.6

87.5–108 MHz BROADBAND REFERENCE CIRCUIT – 2.9" × 5.1" (7.3 cm × 13.0 cm)

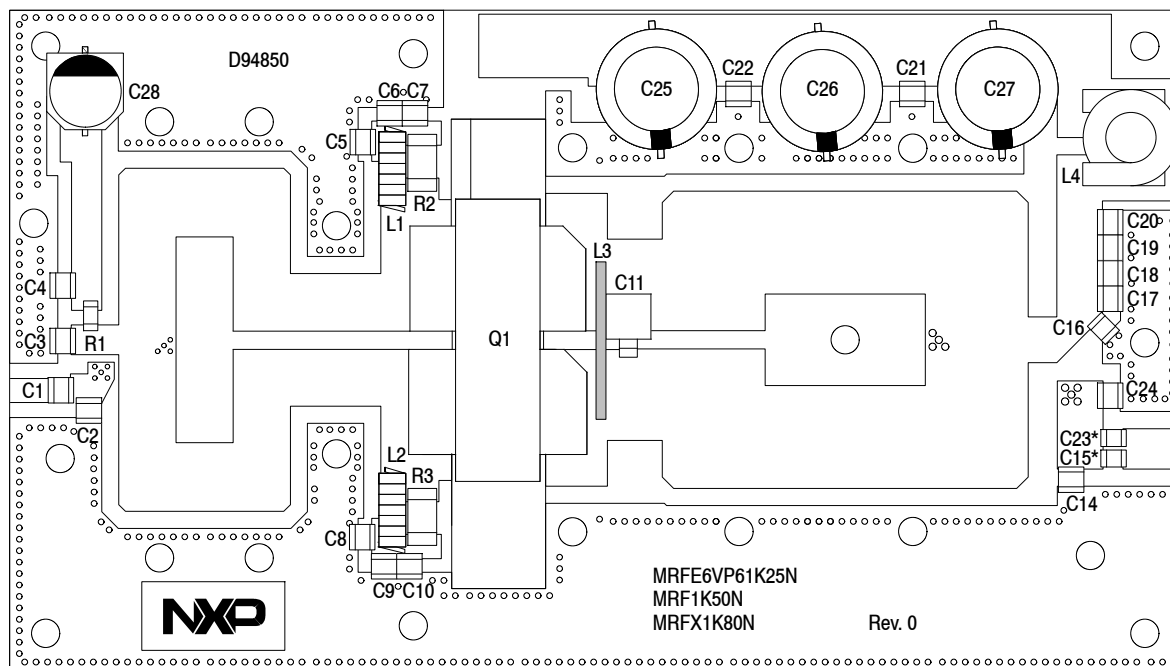

*C15 and C23 are mounted vertically.

Note: Component numbers C12 and C13 are not used.

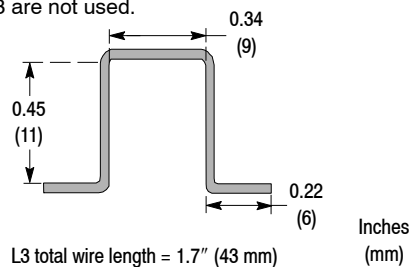

Figure 4. MRFX1K80N 87.5–108 MHz Broadband Reference Circuit Component Layout

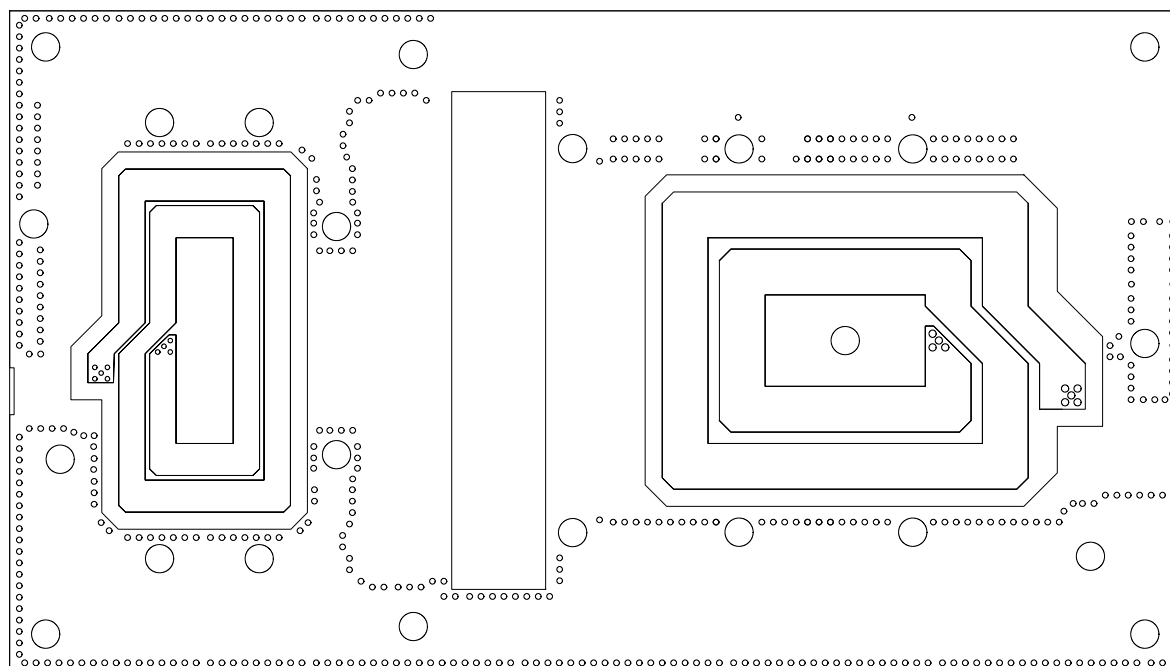

Figure 5. MRFX1K80N 87.5–108 MHz Broadband Reference Circuit Component Layout – Bottom

Table 9. MRFX1K80N 87.5–108 MHz Broadband Reference Circuit Component Designations and Values

Part	Description	Part Number	Manufacturer
C1, C3, C6, C9, C18, C19, C20, C21, C22	1000 pF Chip Capacitor	ATC100B102JT50XT	ATC
C2	33 pF Chip Capacitor	ATC100B330JT500XT	ATC
C4, C5, C8	10,000 pF Chip Capacitor	ATC200B103KT50XT	ATC
C7, C10, C15, C16, C17, C23	470 pF Chip Capacitor	ATC100B471JT200XT	ATC
C11	100 pF, 300 V Mica Capacitor	MIN02-002EC101J-F	CDE
C14, C24	12 pF Chip Capacitor	ATC100B120GT500XT	ATC
C25, C26, C27	220 μ F, 100 V Electrolytic Capacitor	EEV-FC2A221M	Panasonic-ECG
C28	22 μ F, 35 V Electrolytic Capacitor	UUD1V220MCL1GS	Nichicon
L1, L2	17.5 nH Inductor, 6 Turns	B06TJLC	Coilcraft
L3	1.5 mm Non-Tarnish Silver Plated Copper Wire, Total Wire Length = 1.7"/43 mm	SP1500NT-001	Scientific Wire Company
L4	22 nH Inductor	1212VS-22NMEB	Coilcraft
Q1	RF Power LDMOS Transistor	MRFX1K80N	NXP
R1	10 Ω , 1/4 W Chip Resistor	CRCW120610R0JNEA	Vishay
R2, R3	33 Ω , 2 W Chip Resistor	1-2176070-3	TE Connectivity
Thermal Pad	TG Series Soft Thermal Conductive Pad	TG6050-150-150-5.0-0	t-Global Technology
PCB	Rogers TC350 0.030", $\epsilon_r = 3.5$	D94850	MTL

Note: Refer to MRFX1K80N's [printed circuit boards and schematics](#) to download the 87.5–108 MHz baseplate drawing.

**TYPICAL CHARACTERISTICS – 87.5–108 MHz
BROADBAND REFERENCE CIRCUIT**

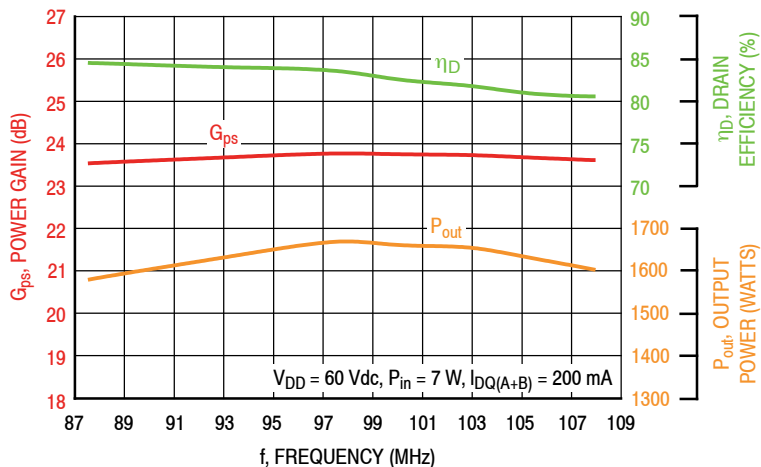

Figure 6. Power Gain, Drain Efficiency and CW Output Power versus Frequency at a Constant Input Power

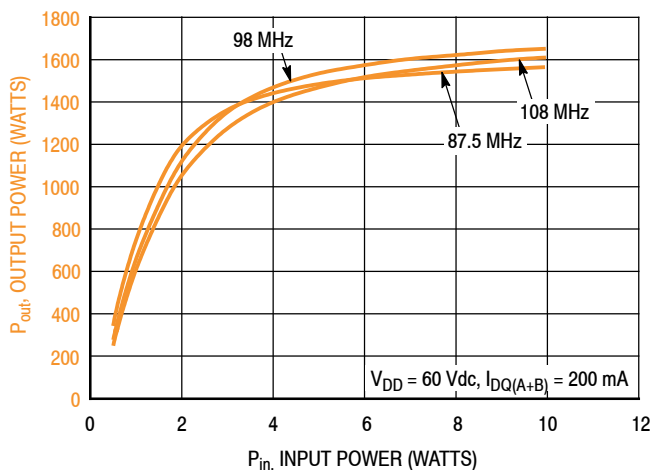

Figure 7. CW Output Power versus Input Power and Frequency

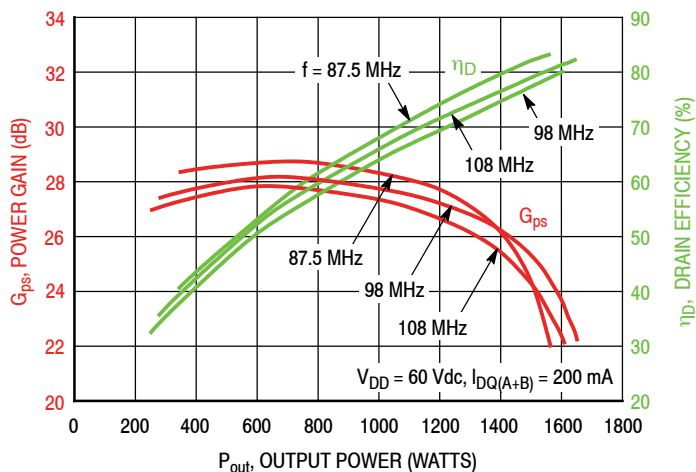
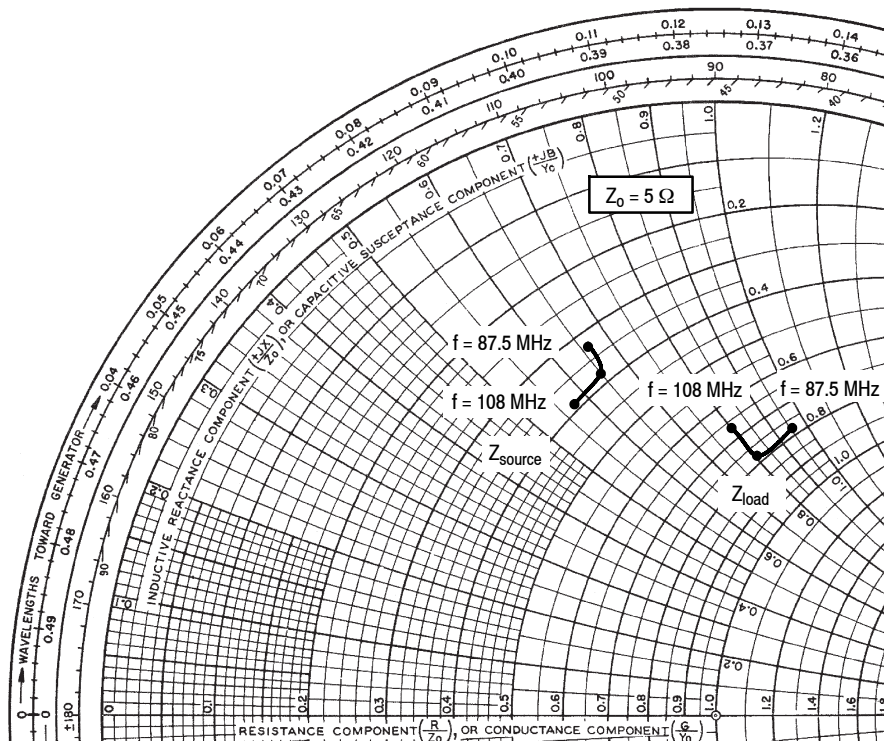

Figure 8. Power Gain and Drain Efficiency versus CW Output Power and Frequency

87.5–108 MHz BROADBAND REFERENCE CIRCUIT



f MHz	Z _{source} Ω	Z _{load} Ω
87.5	1.65 + j3.30	3.90 + j4.73
98	1.91 + j3.25	3.88 + j3.99
108	1.94 + j2.87	3.35 + j3.95

Z_{source} = Test circuit impedance as measured from gate to gate, balanced configuration.

Z_{load} = Test circuit impedance as measured from drain to drain, balanced configuration.

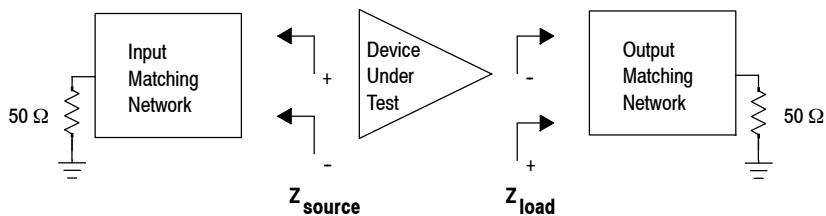

Figure 9. Broadband Series Equivalent Source and Load Impedance – 87.5–108 MHz

**HARMONIC MEASUREMENTS — 87.5–108 MHz
BROADBAND REFERENCE CIRCUIT**

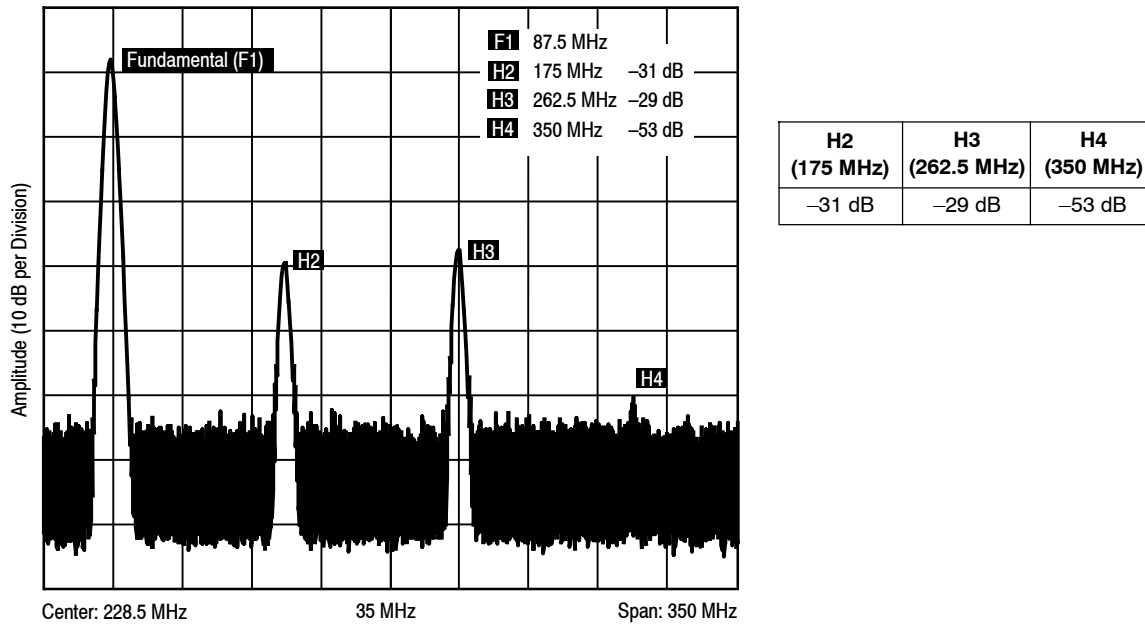

Figure 10. 87.5 MHz Harmonics @ 1500 W CW

230 MHz NARROWBAND PRODUCTION TEST FIXTURE – 6.0" x 4.0" (15.2 cm x 10.2 cm)

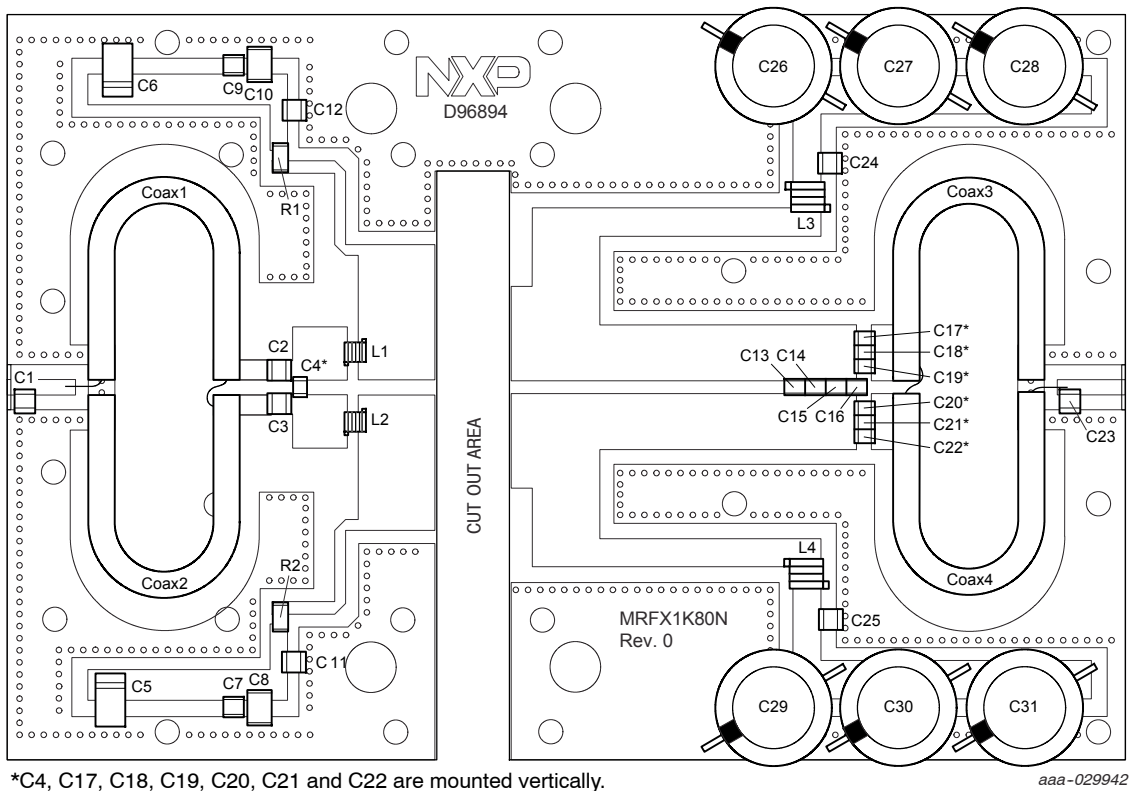

Figure 11. MRFX1K80N Narrowband Production Test Fixture Component Layout – 230 MHz

Table 10. MRFX1K80N Narrowband Production Test Fixture Component Designations and Values – 230 MHz

Part	Description	Part Number	Manufacturer
C1, C2, C3	22 pF Chip Capacitor	ATC100B220JT500XT	ATC
C4	27 pF Chip Capacitor	ATC100B270JT500XT	ATC
C5, C6	22 μ F, 35 V Tantalum Capacitor	T491X226K035AT	Kemet
C7, C9	0.1 μ F Chip Capacitor	CDR33BX104AKWS	AVX
C8, C10	220 nF Chip Capacitor	C1812C224K5RACTU	Kemet
C11, C12, C24, C25	1000 pF Chip Capacitor	ATC100B102JT50XT	ATC
C13	24 pF Chip Capacitor	ATC800R240JT500XT	ATC
C14, C15	20 pF Chip Capacitor	ATC800R200JT500XT	ATC
C16	22 pF Chip Capacitor	ATC800R220JT500XT	ATC
C17, C18, C19, C20, C21, C22	240 pF Chip Capacitor	ATC100B241JT200XT	ATC
C23	8.2 pF Chip Capacitor	ATC100B8R2CT500XT	ATC
C26, C27, C28, C29, C30, C31	470 μ F, 100 V Electrolytic Capacitor	MCGPR100V477M16X32-RH	Multicomp
Coax1, 2, 3, 4	25 Ω Semi Rigid Coax Cable, 2.2" Shield Length	UT-141C-25	Micro-Coax
L1, L2	5 nH Inductor, 2 Turns	A02TKLC	Coilcraft
L3, L4	6.6 nH Inductor, 2 Turns	GA3093-ALC	Coilcraft
R1, R2	10 Ω , 1/4 W Chip Resistor	CRCW120610R0JNEA	Vishay
PCB	Rogers AD255A 0.030", $\epsilon_r = 2.55$	D96894	MTL

**TYPICAL CHARACTERISTICS — 230 MHz, $T_C = 25^\circ\text{C}$
NARROWBAND PRODUCTION TEST FIXTURE**

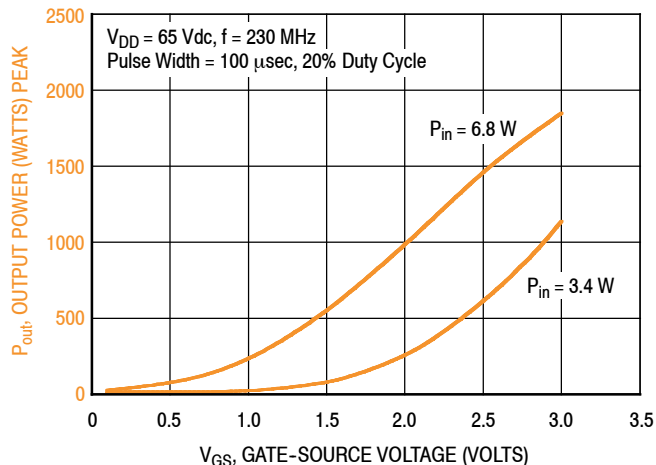
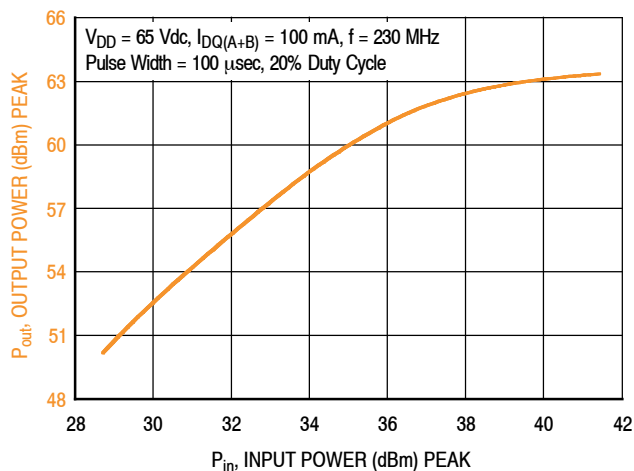

Figure 12. Output Power versus Gate-Source Voltage at a Constant Input Power



f (MHz)	P1dB (W)	P3dB (W)
230	1878	2143

Figure 13. Output Power versus Input Power

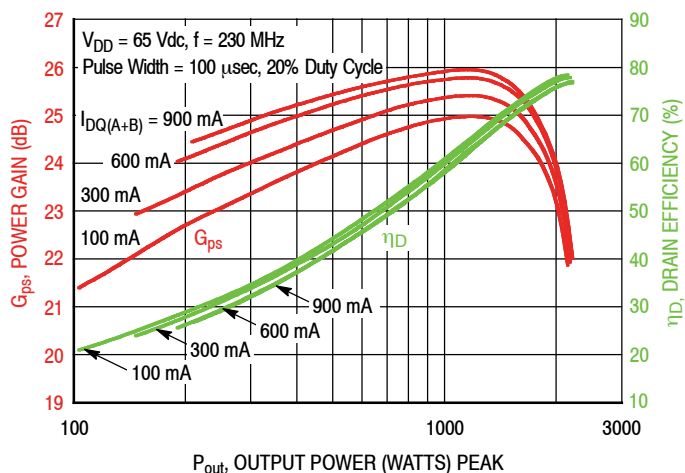

Figure 14. Power Gain and Drain Efficiency versus Output Power and Quiescent Current

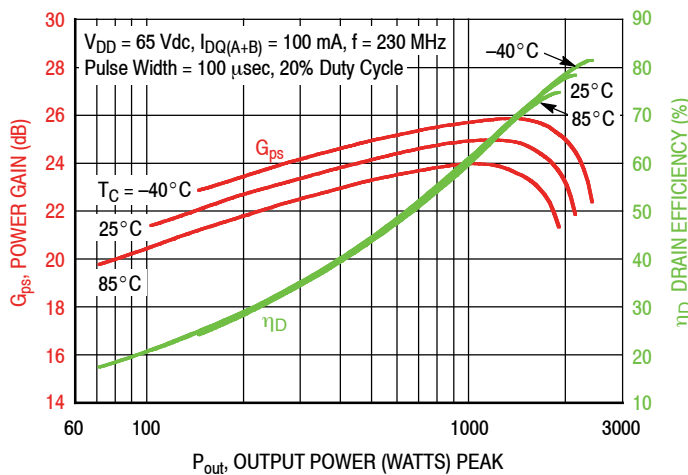

Figure 15. Power Gain and Drain Efficiency versus Output Power

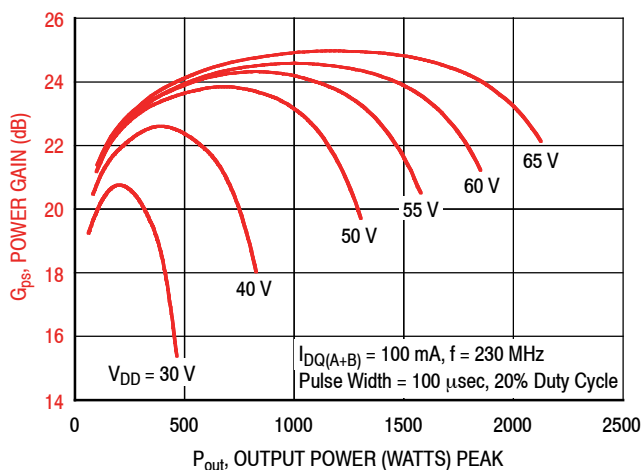

Figure 16. Power Gain versus Output Power and Drain-Source Voltage

230 MHz NARROWBAND PRODUCTION TEST FIXTURE

f MHz	Z_{source} Ω	Z_{load} Ω
230	$0.9 + j2.3$	$1.9 + j2.5$

Z_{source} = Test fixture impedance as measured from gate to gate, balanced configuration.

Z_{load} = Test fixture impedance as measured from drain to drain, balanced configuration.

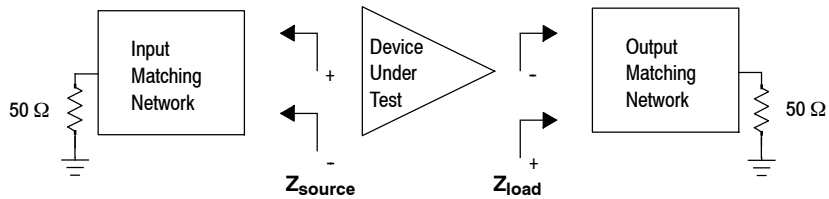
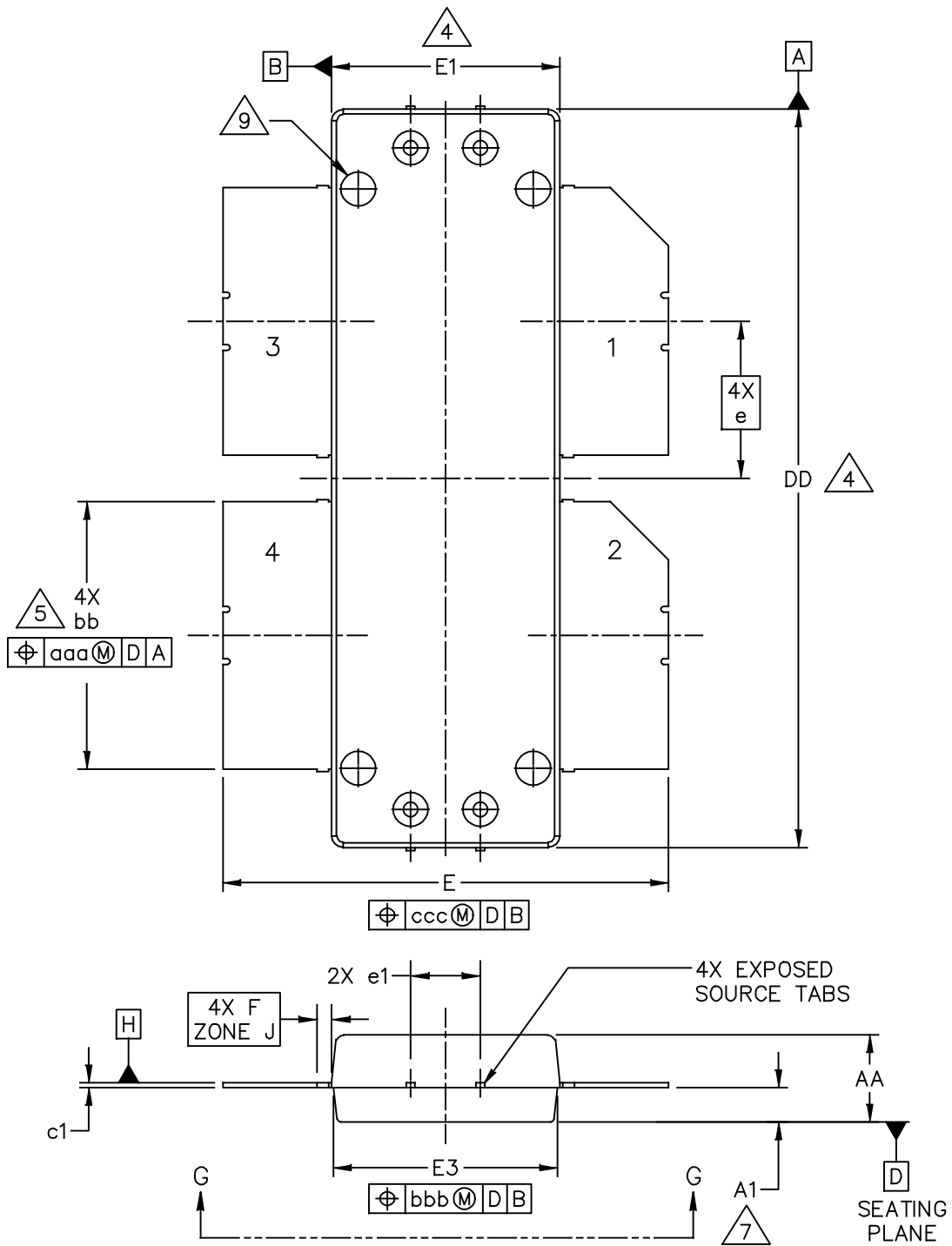
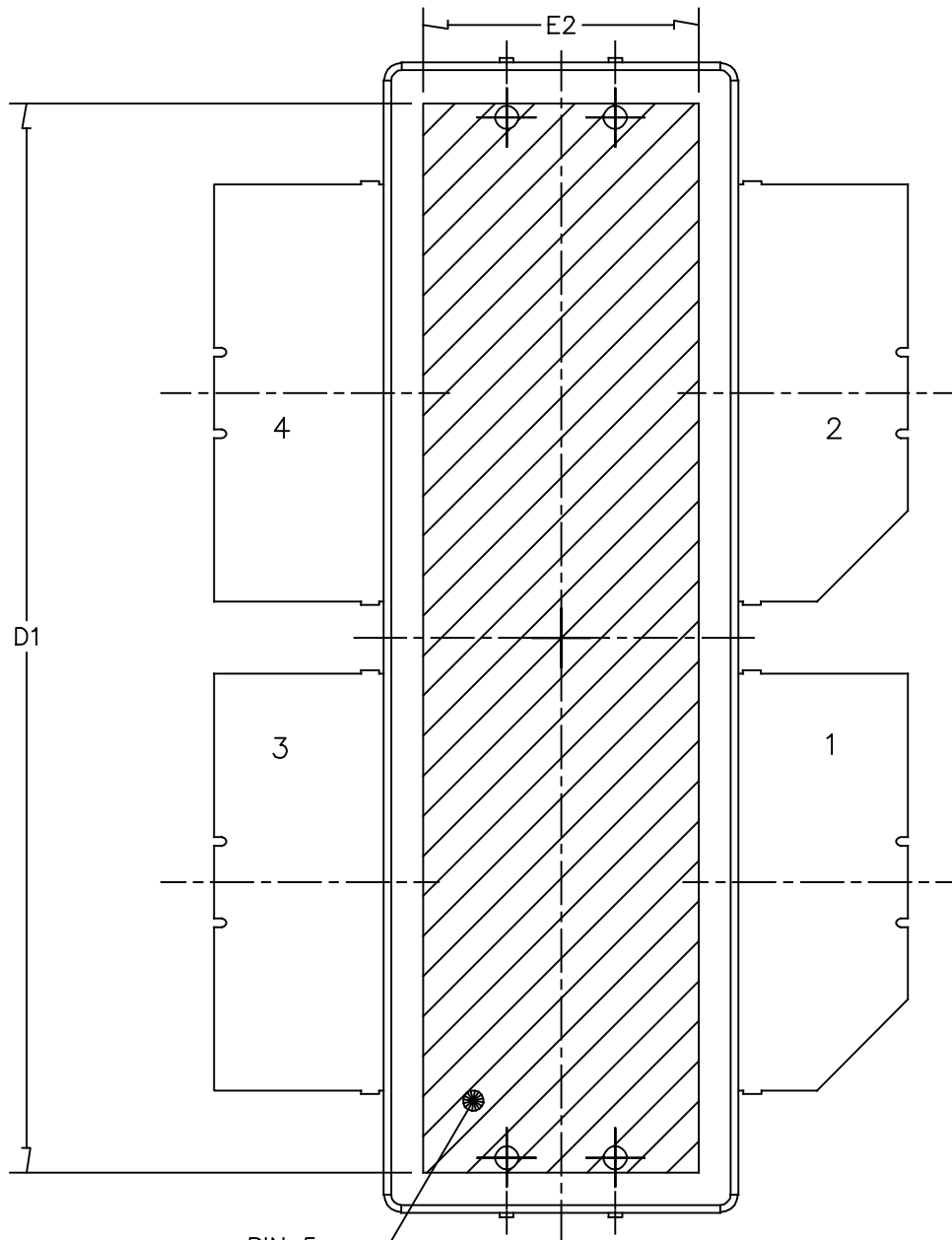

Figure 17. Narrowband Series Equivalent Source and Load Impedance – 230 MHz

PACKAGE DIMENSIONS



© NXP SEMICONDUCTORS N.V. ALL RIGHTS RESERVED	MECHANICAL OUTLINE	PRINT VERSION NOT TO SCALE
TITLE: OM-1230-4L	DOCUMENT NO: 98ASA00506D	REV: C
	STANDARD: NON-JEDEC	
	SOT1816-1	08 FEB 2016



PIN 5

BOTTOM VIEW
 VIEW G-G

© NXP SEMICONDUCTORS N.V. ALL RIGHTS RESERVED	MECHANICAL OUTLINE	PRINT VERSION NOT TO SCALE	
TITLE: OM-1230-4L	DOCUMENT NO: 98ASA00506D		REV: C
	STANDARD: NON-JEDEC		
	SOT1816-1	08 FEB 2016	

NOTES:

1. CONTROLLING DIMENSION: INCH
2. INTERPRET DIMENSIONS AND TOLERANCES PER ASME Y14.5M-1994.
3. DATUM PLANE H IS LOCATED AT TOP OF LEAD AND IS COINCIDENT WITH THE LEAD WHERE THE LEAD EXITS THE PLASTIC BODY AT THE TOP OF THE PARTING LINE.
4. DIMENSIONS DD AND E1 DO NOT INCLUDE MOLD PROTRUSION. ALLOWABLE PROTRUSION IS .006 INCH (0.15 MM) PER SIDE. DIMENSIONS DD AND E1 DO INCLUDE MOLD MISMATCH AND ARE DETERMINED AT DATUM PLANE H.
5. DIMENSION bb DOES NOT INCLUDE DAMBAR PROTRUSION. ALLOWABLE DAMBAR PROTRUSION SHALL BE .005 INCH (0.13 MM) TOTAL IN EXCESS OF THE bb DIMENSION AT MAXIMUM MATERIAL CONDITION.
6. DATUMS A AND B TO BE DETERMINED AT DATUM PLANE H.
7. DIMENSION A1 APPLIES WITHIN ZONE J ONLY.
8. HATCHING REPRESENTS THE EXPOSED AREA OF THE HEAT SLUG. THE DIMENSIONS D1 AND E2 REPRESENT THE VALUES BETWEEN THE TWO OPPOSITE POINTS ALONG THE EDGES OF EXPOSED AREA OF HEAT SLUG.
9. DIMPLED HOLE REPRESENTS INPUT SIDE.

DIM	INCH		MILLIMETER		DIM	INCH		MILLIMETER	
	MIN	MAX	MIN	MAX		MIN	MAX	MIN	MAX
AA	.148	.152	3.76	3.86	bb	.457	.463	11.61	11.76
A1	.059	.065	1.50	1.65	c1	.007	.011	0.18	0.28
DD	1.267	1.273	32.18	32.33	e	.270 BSC		6.86 BSC	
D1	1.180	----	29.97	----	e1	.116	.124	2.95	3.15
E	.762	.770	19.35	19.56					
E1	.390	.394	9.91	10.01	aaa	.004		0.10	
E2	.306	----	7.77	----	bbb	.006		0.15	
E3	.383	.387	9.73	9.83	ccc	.010		0.25	
F	.025 BSC		0.635 BSC						

© NXP SEMICONDUCTORS N.V. ALL RIGHTS RESERVED	MECHANICAL OUTLINE	PRINT VERSION NOT TO SCALE
TITLE: OM-1230-4L	DOCUMENT NO: 98ASA00506D REV: C	
	STANDARD: NON-JEDEC	
	SOT1816-1 08 FEB 2016	



© NXP SEMICONDUCTORS N.V. ALL RIGHTS RESERVED	MECHANICAL OUTLINE	PRINT VERSION NOT TO SCALE
TITLE: OM-1230G-4L	DOCUMENT NO: 98ASA00818D	REV: B
	STANDARD: NON-JEDEC	
	SOT1824-1	18 FEB 2016

MRFX1K80N MRFX1K80GN



© NXP SEMICONDUCTORS N.V. ALL RIGHTS RESERVED	MECHANICAL OUTLINE	PRINT VERSION NOT TO SCALE
TITLE: OM-1230G-4L	DOCUMENT NO: 98ASA00818D REV: B	
	STANDARD: NON-JEDEC	
	SOT1824-1	18 FEB 2016

NOTES:

1. CONTROLLING DIMENSION: INCH
2. INTERPRET DIMENSIONS AND TOLERANCES PER ASME Y14.5M-1994.
3. DATUM PLANE H IS LOCATED AT TOP OF LEAD AND IS COINCIDENT WITH THE LEAD WHERE THE LEAD EXITS THE PLASTIC BODY AT THE TOP OF THE PARTING LINE.
4. DIMENSIONS DD AND E1 DO NOT INCLUDE MOLD PROTRUSION. ALLOWABLE PROTRUSION IS .006 INCH (0.15 MM) PER SIDE. DIMENSIONS DD AND E1 DO INCLUDE MOLD MISMATCH AND ARE DETERMINED AT DATUM PLANE H.
5. DIMENSION bb DOES NOT INCLUDE DAMBAR PROTRUSION. ALLOWABLE DAMBAR PROTRUSION SHALL BE .005 INCH (0.13 MM) TOTAL IN EXCESS OF THE bb DIMENSION AT MAXIMUM MATERIAL CONDITION.
6. DATUMS A AND B TO BE DETERMINED AT DATUM PLANE H.
7. HATCHING REPRESENTS THE EXPOSED AND SOLDERABLE AREA OF THE HEAT SLUG. THE DIMENSIONS D1 AND E2 REPRESENT THE VALUES BETWEEN THE TWO OPPOSITE POINTS ALONG THE EDGES OF EXPOSED AREA OF HEAT SLUG.
8. DIMPLED HOLE REPRESENTS INPUT SIDE.
9. DIMENSION A1 IS MEASURED WITH REFERENCE TO DATUM D. THE POSITIVE VALUE IMPLIES THAT THE BOTTOM OF THE PACKAGE IS HIGHER THAN THE BOTTOM OF THE LEAD.

DIM	INCH		MILLIMETER		DIM	INCH		MILLIMETER	
	MIN	MAX	MIN	MAX		MIN	MAX	MIN	MAX
AA	.148	.152	3.76	3.86	bb	.457	.463	11.61	11.76
A1	-.003	.003	-0.08	0.08	c1	.007	.011	0.18	0.28
DD	1.267	1.273	32.18	32.33	e	.270 BSC		6.86 BSC	
D1	1.180	----	29.97	----	e1	.116	.124	2.95	3.15
E	.563	.575	14.30	14.61	θ	0°	8°	0°	8°
E1	.390	.394	9.91	10.01	aaa	.004		0.10	
E2	.306	----	7.77	----	bbb	.006		0.15	
E3	.383	.387	9.73	9.83	ccc	.010		0.25	
L	.034	.046	0.86	1.17					
L1	.010 BSC		0.25 BSC						

© NXP SEMICONDUCTORS N.V. ALL RIGHTS RESERVED		MECHANICAL OUTLINE	PRINT VERSION NOT TO SCALE
TITLE: OM-1230G-4L		DOCUMENT NO: 98ASA00818D REV: B	
		STANDARD: NON-JEDEC	
		SOT1824-1	18 FEB 2016

PRODUCT DOCUMENTATION, SOFTWARE AND TOOLS

Refer to the following resources to aid your design process.

Application Notes

- AN1907: Solder Reflow Attach Method for High Power RF Devices in Over-Molded Plastic Packages
- AN1955: Thermal Measurement Methodology of RF Power Amplifiers

Engineering Bulletins

- EB212: Using Data Sheet Impedances for RF LDMOS Devices

Software

- Electromigration MTTF Calculator
- RF High Power Model
- .s2p File

Development Tools

- Printed Circuit Boards

To Download Resources Specific to a Given Part Number:

1. Go to <http://www.nxp.com/RF>
2. Search by part number
3. Click part number link
4. Choose the desired resource from the drop down menu

REVISION HISTORY

The following table summarizes revisions to this document.

Revision	Date	Description
0	Apr. 2018	• Initial release of data sheet

How to Reach Us:

Home Page:
nxp.com

Web Support:
nxp.com/support

Information in this document is provided solely to enable system and software implementers to use NXP products. There are no express or implied copyright licenses granted hereunder to design or fabricate any integrated circuits based on the information in this document. NXP reserves the right to make changes without further notice to any products herein.

NXP makes no warranty, representation, or guarantee regarding the suitability of its products for any particular purpose, nor does NXP assume any liability arising out of the application or use of any product or circuit, and specifically disclaims any and all liability, including without limitation consequential or incidental damages. "Typical" parameters that may be provided in NXP data sheets and/or specifications can and do vary in different applications, and actual performance may vary over time. All operating parameters, including "typicals," must be validated for each customer application by customer's technical experts. NXP does not convey any license under its patent rights nor the rights of others. NXP sells products pursuant to standard terms and conditions of sale, which can be found at the following address: nxp.com/SalesTermsandConditions.

NXP and the NXP logo are trademarks of NXP B.V. All other product or service names are the property of their respective owners.

© 2018 NXP B.V.



Компания «Life Electronics» занимается поставками электронных компонентов импортного и отечественного производства от производителей и со складов крупных дистрибьюторов Европы, Америки и Азии.

С конца 2013 года компания активно расширяет линейку поставок компонентов по направлению коаксиальный кабель, кварцевые генераторы и конденсаторы (керамические, пленочные, электролитические), за счёт заключения дистрибьюторских договоров

Мы предлагаем:

- Конкурентоспособные цены и скидки постоянным клиентам.
- Специальные условия для постоянных клиентов.
- Подбор аналогов.
- Поставку компонентов в любых объемах, удовлетворяющих вашим потребностям.
- Приемлемые сроки поставки, возможна ускоренная поставка.
- Доставку товара в любую точку России и стран СНГ.
- Комплексную поставку.
- Работу по проектам и поставку образцов.
- Формирование склада под заказчика.
- Сертификаты соответствия на поставляемую продукцию (по желанию клиента).
- Тестирование поставляемой продукции.
- Поставку компонентов, требующих военную и космическую приемку.
- Входной контроль качества.
- Наличие сертификата ISO.

В составе нашей компании организован Конструкторский отдел, призванный помогать разработчикам, и инженерам.

Конструкторский отдел помогает осуществить:

- Регистрацию проекта у производителя компонентов.
- Техническую поддержку проекта.
- Защиту от снятия компонента с производства.
- Оценку стоимости проекта по компонентам.
- Изготовление тестовой платы монтаж и пусконаладочные работы.



Тел: +7 (812) 336 43 04 (многоканальный)

Email: org@lifeelectronics.ru