

# DB subminiature switch





## Features

- Precision switch with high repeat accuracy
- Available for up to 120 °C operating temperature
- Nominal current up to 10A at 250 VAC
- Various auxiliary actuators (can also be retrofitted) two mounting positions
- Various application-specific contact materials
- Mechanical operational life up to  $15 \times 10^6$  actuations
- Wide variety of terminal types

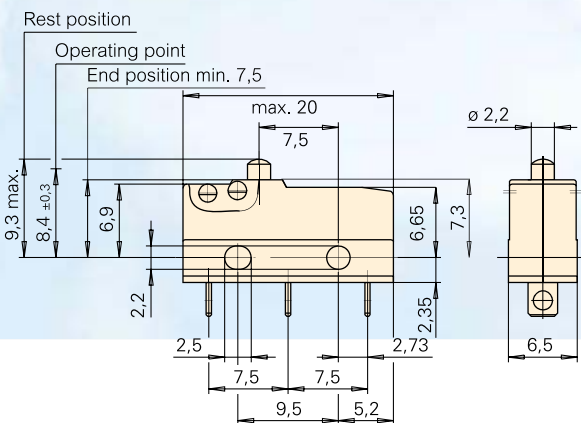
## Dimensions in mm



## Technical specifications

Contact configuration	S.P.D.T., S.P.S.T. - N.O., S.P.S.T. - N.C.
Contact gap	< 3 mm ( $\mu$ )
Switching voltage max.	250 V AC
Switched current	0,1 to 10 A AC, dependig on model (see table)
Operating force	70 to 280 cN without auxiliary actuator, depending on model
Total travel	1,6 mm
Mechanical life	Min. $10 \times 10^6$ operations (see table)
Electrical life (max. load)	Up to $10^6$ operations (see table)
Ambient temperature	-40 to +85 °C/120 °C
Proof tracking index	PTI 175 (PTI 250 on request)
<b>Materials</b>	
Base	PET (UL 94 VO)
Cover	PBT (UL 94 VO)
Actuator	PBT (UL 94 VO) T120 POM (UL 94 HB) T85
Contacts	Ag, AgNi, AuAgPt (Crosspoint)
Terminals	CuZn (silver-plated)
Auxiliary actuator	Stainless steel or plastic
Approvals	   dependig on model
Degree of protection (switch interior)	IP50

For detailed information and the layout of the details described above, please do not hesitate to ask for our technical specifications and drawing.

## Terminals

Q.C. terminal 2,8 x 0,5

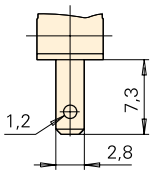

Solder terminal, short

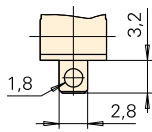

PCB terminal 1,3 x 0,5  
straight

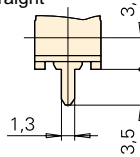

PCB terminal 0,6 x 0,5  
straight

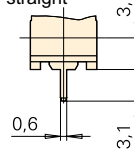

PCB terminal 0,6 x 0,5  
RH-side w/o location pins

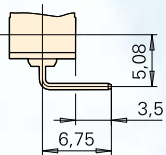

PCB terminal 0,6 x 0,5  
LH-side w/o location pins

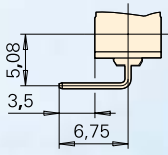

PCB terminal 0,6 x 0,5  
RH-side with location pins

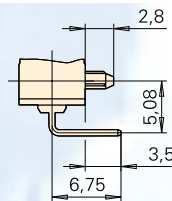

PCB terminal 0,6 x 0,5  
LH-side with location pins

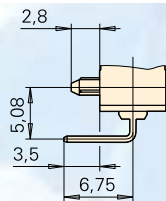

Side definition with terminals  
and location pins

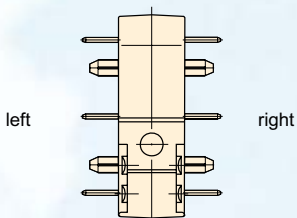

## Auxiliary actuator options

Steel auxiliary actuator

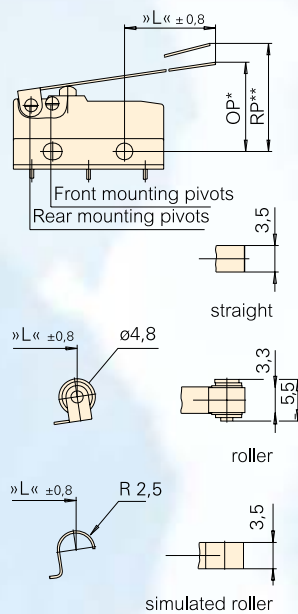

Plastic auxiliary actuator with/without  
adjusting screw

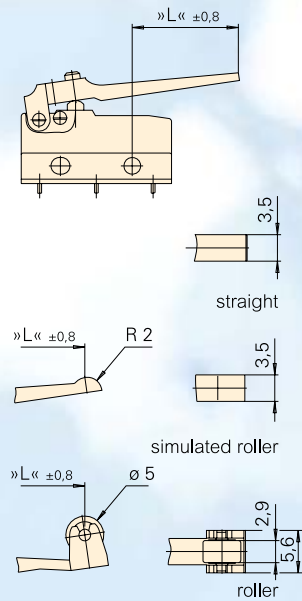

## Electrical rating and operating life (2)

Electrical rating according to EN 61058	UL 1054	Electrical life at rated load for 40T85* acc. to EN (Operations)	Electrical life at rated load for 40T85* acc. to UL	Mechanical life	Max. operating force (cN)	Code
6A 250 V AC	5 A 125–250 V AC	10.000	6.000	15 x 10 <sup>6</sup>	150	1
10 (1,5) A, 250 V AC	10,1 A, 125–250 AC, 1/4 HP, 125 V AC	10.000	6.000	10 x 10 <sup>6</sup>	250	2
0.1 A, 250 V AC	0,1 A 125–250 V AC	50.000	100.000	15 x 10 <sup>6</sup>	150	3
4 A, 250 V~	4 A, 125–250 V AC	50.000	6.000	15 x 10 <sup>6</sup>	90	4
1 A, 250 V AC	1 A, 125–250 V AC	50.000	6.000	15 x 10 <sup>6</sup>	70	5*
6 A, 250 V AC	5 A, 125–250 V AC	50.000	6.000	15 x 10 <sup>6</sup>	150	6*
10 (1,5) A, 250 V AC	10.1 A, 125–250 V AC, 1/4 HP, 125 V AC	50.000	6.000	10 x 10 <sup>6</sup>	280	7*
10 (3) A, 250 V~	10.1 A, 125–250 V AC, 1/4 HP, 125 V AC	10.000	6.000	10 x 10 <sup>6</sup>	280	L
3 A, 250 V~	3 A, 125–250 V AC	50.000	6.000	15 x 10 <sup>6</sup>	90	M
6 (2) A, 250 V~	5 A, 125–250 V AC	25.000	6.000	15 x 10 <sup>6</sup>	150	O
Special models designed for very low switching loads on request						*only T85

## Contact configuration (3)

Contact configuration	Code
Ambient temperature 40T85	Code
S.P.S.T. - N.O.	E
S.P.S.T. - N.C.	F
S.P.D.T.	G
Ambient temperature 40T120	Code
S.P.S.T. - N.O.	A
S.P.S.T. - N.C.	B
S.P.D.T.	C

## Terminals (4)

Type of terminal	Code
Q.C. terminal 2.8 x 0.5 mm, straight	B1
Solder terminal, short	A1
PCB terminal 1.3 x 0.5, straight	C1
PCB terminal 0.6 x 0.5, straight	D1
PCB terminal 0.6 x 0.5, right-hand side*	D2
PCB terminal 0.6 x 0.5, left-hand side*	D3
PCB terminal 0.6 x 0.5, right-hand side**	D4
PCB terminal 0.6 x 0.5, left-hand side**	D5

\*with location pins \*\* without location pins

## Auxiliary actuator options (5)

Model	Mounting point	Length	Code
Without lever, spherical head	–	–	AA
	–	–	BA
Straight	RM rear	4,8	LB
		7	LC
	FM front	42	LD
		7	MB
		9,4	MC
Roller	RM rear	43,5	MD
		2,5	RB
		4,7	RC
	FM front	39,7	RD
		4,7	TB
		7,1	TC
		41,2	TD
Simulated roller	RM rear	2,5	SB
		4,7	SC
		39,7	SD
	FM front	4,7	UB
		7,1	UC
Plastic straight	RM rear	41,2	UD
		7	WB
	FM front	14	WC
		9,4	GB
Plastic roller	16,2	GC	
	RM rear	5,2	ZB
FM front	7,3	OB	
Plastic simulated roller	RM rear	5,6	VB
	FM front	7,9	HB

## Switching parameters

Option	Type	Max. operating force (cN)	Max. pretravel (mm)	Min. overtravel (mm)	Max. movement differential (mm)	Max. rest position (mm)	Operating point (mm)	Length actuator (mm) $\pm 0,8$
Spherical-head actuator, w/o auxiliary actuator	DB5	70	1,0	0,6	0,1	9,3	8,4 $\pm 0,3$	-
	DB1/O	150	1,0	0,6	0,1	9,3	8,4 $\pm 0,3$	
	DB6	150	1,0	0,6	0,15	9,3	8,4 $\pm 0,3$	
	DB2	250	1,0	0,6	0,1	9,3	8,4 $\pm 0,3$	
Actuator with radius, w/o auxiliary actuator	DB7	280	1,0	0,6	0,15	9,3	8,4 $\pm 0,3$	-
	DB5	70	1,0	0,6	0,1	9,3	8,4 $\pm 0,3$	
	DB1/O	150	1,0	0,6	0,1	9,3	8,4 $\pm 0,3$	
	DB6	250	1,0	0,6	0,15	9,3	8,4 $\pm 0,3$	
	DB2	250	1,0	0,6	0,1	9,3	8,4 $\pm 0,3$	-
	DB7	280	1,0	0,6	0,15	9,3	8,4 $\pm 0,3$	

## Contact rating at direct voltage

Switching voltage	Switched current, resistive load		Inductive load (L/R = 3 ms)	
	DB 1	DB 2	DB 1	DB 2
12 V	6 A	10 A	6 A	10 A
24 V	3 A	5 A	2 A	4 A
60 V	1 A	1 A	0,5 A	0,5 A
110 V	0,5 A	0,5 A	0,2 A	0,2 A
220 V	0,25 A	0,25 A	0,1 A	0,1 A

## Drilling patterns

drilling pattern for PCB terminal 1,3 x 0,5 mm

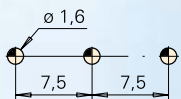

drilling pattern for PCB terminal 0,6 x 0,5 mm straight/lateral

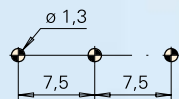

drilling pattern for PCB terminal 0,6 x 0,5 mm lateral with location pins

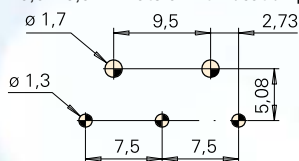

Компания «Life Electronics» занимается поставками электронных компонентов импортного и отечественного производства от производителей и со складов крупных дистрибьюторов Европы, Америки и Азии.

С конца 2013 года компания активно расширяет линейку поставок компонентов по направлению коаксиальный кабель, кварцевые генераторы и конденсаторы (керамические, пленочные, электролитические), за счёт заключения дистрибьюторских договоров

Мы предлагаем:

- Конкурентоспособные цены и скидки постоянным клиентам.
- Специальные условия для постоянных клиентов.
- Подбор аналогов.
- Поставку компонентов в любых объемах, удовлетворяющих вашим потребностям.
- Приемлемые сроки поставки, возможна ускоренная поставка.
- Доставку товара в любую точку России и стран СНГ.
- Комплексную поставку.
- Работу по проектам и поставку образцов.
- Формирование склада под заказчика.
- Сертификаты соответствия на поставляемую продукцию (по желанию клиента).
- Тестирование поставляемой продукции.
- Поставку компонентов, требующих военную и космическую приемку.
- Входной контроль качества.
- Наличие сертификата ISO.

В составе нашей компании организован Конструкторский отдел, призванный помогать разработчикам, и инженерам.

Конструкторский отдел помогает осуществить:

- Регистрацию проекта у производителя компонентов.
- Техническую поддержку проекта.
- Защиту от снятия компонента с производства.
- Оценку стоимости проекта по компонентам.
- Изготовление тестовой платы монтаж и пусконаладочные работы.



Тел: +7 (812) 336 43 04 (многоканальный)

Email: [org@lifeelectronics.ru](mailto:org@lifeelectronics.ru)