

## Power CMOS Drivers With Voltage Tripler

### Features

- Power Driver With On Board Voltage Booster
- Low  $I_{DD}$  – <4mA
- Small Package – 8-Pin PDIP
- Under-Voltage Circuitry
- Fast Rise-Fall Time – <40nsec @ 1000pF
- Below-Rail Input Protection

### Applications

- Raises 5V to drive higher – Vgs (ON) MOSFETs
- Eliminates one system power supply

### Device Selection Table

Part Number	Package	Temp. Range
TC4626COE	16-Pin SOIC (Wide)	-55°C to +125°C
TC4626CPA	8-Pin PDIP	-40°C to +85°C
TC4626EOE	16-Pin SOIC (Wide)	-40°C to +85°C
TC4626EPA	8-Pin PDIP	0°C to +70°C
TC4626MJA	8-Pin CERDIP	0°C to +70°C
TC4627COE	16-Pin SOIC (Wide)	-55°C to +125°C
TC4627CPA	8-Pin PDIP	-40°C to +85°C
TC4627EOE	16-Pin SOIC (Wide)	-40°C to +85°C
TC4627EPA	8-Pin PDIP	0°C to +70°C
TC4627MJA	8-Pin CERDIP	0°C to +70°C

### Package Type



### General Description

The TC4626/TC4627 are single CMOS high speed drivers with an on-board voltage boost circuit. These parts work with an input supply voltage from 4 to 6 volts. The internal voltage booster will produce a  $V_{BOOST}$  potential up to 12 volts above  $V_{IN}$ . This  $V_{BOOST}$  is not regulated, so its voltage is dependent on the input  $V_{DD}$  voltage and output drive loading requirements. An internal undervoltage lockout circuit keeps the output in a low state when  $V_{BOOST}$  drops below 7.8 volts. Output is enabled when  $V_{BOOST}$  is above 11.3 volts.

### Functional Block Diagram



# TC4626/TC4627

## 1.0 ELECTRICAL CHARACTERISTICS

### Absolute Maximum Ratings\*

Supply Voltage .....	6.2V
Input Voltage, Any Terminal .....	$V_S + 0.3V$ to $GND - 0.3V$
Package Power Dissipation ( $T_A \leq 70^\circ C$ )	
PDIP .....	730mW
CERDIP .....	800mW
SOIC .....	760mW
Derating Factor   PDIP .....	5.6 mW/ $^\circ C$ Above $36^\circ C$
CERDIP .....	6.0mW/ $^\circ C$
Operating Temperature Range (Ambient)	
C Version .....	$0^\circ C$ to $+70^\circ C$
E Version .....	$-40^\circ C$ to $+85^\circ C$
M Version .....	$-55^\circ C$ to $+125^\circ C$
Storage Temperature Range .....	$-65^\circ C$ to $+150^\circ C$

\*Stresses above those listed under "Absolute Maximum Ratings" may cause permanent damage to the device. These are stress ratings only and functional operation of the device at these or any other conditions above those indicated in the operation sections of the specifications is not implied. Exposure to Absolute Maximum Rating conditions for extended periods may affect device reliability.

### TC4626/TC4627 ELECTRICAL SPECIFICATIONS

Electrical Characteristics: $T_A = +25^\circ C$ , $V_{DD} = 5V$ , $C_1 = C_2 = C_3 = 10\mu F$ unless otherwise noted.						
Symbol	Parameter	Min	Typ	Max	Units	Test Conditions
<b>Input</b>						
$V_{IH}$	Logic 1, High Input Voltage	2.4	—	—	V	
$V_{IL}$	Logic 0, Low Input Voltage	—	—	0.8	V	
$I_{IN}$	Input Current	-1	—	1	$\mu A$	$0V \leq V_{IN} \leq V_{DRIVE}$
<b>Output</b>						
$V_{OH}$	High Output Voltage	$V_{BOOST} - 0.025$	—	—	V	
$V_{OL}$	Low Output Voltage	—	—	0.025	V	
$R_O$	Output Resistance, High	—	10	15	$\Omega$	$I_{OUT} = 10mA$ , $V_{DD} = 5V$
$R_O$	Output Resistance, Low	—	8	10	$\Omega$	$I_{OUT} = 10mA$ , $V_{DD} = 5V$
$I_{PK}$	Peak Output Current	—	1.5	—	A	
<b>Switching Time</b>						
$t_R$	Rise Time	—	33	40	nsec	Figure 3-1, Figure 3-2
$t_F$	Fall Time	—	27	35	nsec	Figure 3-1, Figure 3-2
$t_{D1}$	Delay Time	—	35	45	nsec	Figure 3-1, Figure 3-2
$t_{D2}$	Delay Time	—	45	55	nsec	Figure 3-1, Figure 3-2
$F_{MAX}$	Maximum Switching Frequency	1.0	—	—	MHz	$V_{DD} = 5V$ , $V_{BOOST} > 8.5V$ , Figure 3-1
<b>Voltage Booster</b>						
$R_3$	Voltage Tripler Output Source Resistance	—	300	400	$\Omega$	$I_L = 10mA$ , $V_{DD} = 5V$
$R_2$	Voltage Doubler Output Source Resistance	—	120	200	$\Omega$	
$F_{OSC}$	Oscillator Frequency	12	—	28	kHz	
$V_{OSC}$	Oscillator Amplitude Measured at C1-	4.5	—	10	V	$R_{LOAD} = 10k\Omega$
$UV @ V_{BOOST}$	Undervoltage Threshold	7.0	7.8	8.5	V	
$V_{START} @ V_{BOOST}$	Start Up Voltage	10.5	11.3	12	V	
$V_{BOOST}$	@ $V_{DD} = 5V$	14.6	—	—	V	No Load

## TC4626/TC4627 ELECTRICAL SPECIFICATIONS (CONTINUED)

Symbol	Parameter	Min	Typ	Max	Units	Test Conditions
<b>Power Supply</b>						
I <sub>DD</sub>	Power Supply Current	—	—	2.5	mA	V <sub>IN</sub> = LOW or HIGH
V <sub>DD</sub>	Supply Voltage	4.0	—	6.0	V	
<b>Electrical Characteristics:</b> Over operating temperature range, V <sub>DD</sub> = 5V, C <sub>1</sub> = C <sub>2</sub> = C <sub>3</sub> 10μF unless otherwise noted.						
Symbol	Parameter	Min	Typ	Max	Units	Test Conditions
<b>Input</b>						
V <sub>IH</sub>	Logic 1, High Input Voltage	2.4	—	—	V	
V <sub>IL</sub>	Logic 0, Low Input Voltage	—	—	0.8	V	
I <sub>IN</sub>	Input Current	-10	—	1	μA	0V ≤ V <sub>IN</sub> ≤ V <sub>BOOST</sub>
<b>Output</b>						
V <sub>OH</sub>	High Output Voltage	V <sub>DRIVE</sub> - 0.025	—	—	V	
V <sub>OL</sub>	Low Output Voltage	—	—	0.025	V	
R <sub>O</sub>	Output Resistance, High	—	15 15	20 25	Ω	I <sub>OUT</sub> = 10mA, V <sub>DD</sub> = 5V C & E Version (T <sub>A</sub> = 70°C or 85°C) M Version (T <sub>A</sub> = 125°C)
R <sub>O</sub>	Output Resistance, Low	—	10 10	13 15	Ω	I <sub>OUT</sub> = 10mA, V <sub>DD</sub> = 5V C & E Version (T <sub>A</sub> = 70°C or 85°C) M Version (T <sub>A</sub> = 125°C)
I <sub>PK</sub>	Peak Output Current	—	1.5	—	A	
<b>Switching Time</b>						
t <sub>R</sub>	Rise Time	—	—	55	nsec	Figure 3-1, Figure 3-2
t <sub>F</sub>	Fall Time	—	—	50	nsec	Figure 3-1, Figure 3-2
t <sub>D1</sub>	Delay Time	—	—	60	nsec	Figure 3-1, Figure 3-2
t <sub>D2</sub>	Delay Time	—	—	70	nsec	Figure 3-1, Figure 3-2
F <sub>MAX</sub>	Maximum Switching Frequency	750	—	—	kHz	V <sub>DD</sub> = 5V, V <sub>BOOST</sub> > 8.5V, Figure 3-1
<b>Voltage Booster</b>						
R <sub>3</sub>	Voltage Boost Output Source Resistance	—	400	500	Ω	I <sub>L</sub> = 10mA, V <sub>DD</sub> = 5V
R <sub>2</sub>	Voltage Doubler Output Source Resistance	—	170	300	Ω	
F <sub>OSC</sub>	Oscillator Frequency	5	—	50	kHz	
V <sub>OSC</sub>	Oscillator Amplitude Measured at C1-	4.5	—	10	V	R <sub>LOAD</sub> = 10kΩ
UV @V <sub>BOOST</sub>	Undervoltage Threshold	7.0	7.8	8.5	V	
V <sub>START</sub> @V <sub>BOOST</sub>	Start Up Voltage	10.5	11.3	12	V	
V <sub>BOOST</sub>	@V <sub>DD</sub> = 5V	14.6	—	—	V	No Load
<b>Power Supply</b>						
I <sub>DD</sub>	Power Supply Current	—	—	4	mA	V <sub>IN</sub> = LOW or HIGH
V <sub>DD</sub>	Supply Voltage	4.0	—	6.0	V	

# TC4626/TC4627

---

---

## 2.0 PIN DESCRIPTIONS

The descriptions of the pins are listed in Table 2-1.

**TABLE 2-1: PIN FUNCTION TABLE**

Pin No. (8-Pin PDIP, CERDIP)	Symbol	Description
1	C1-	
2	C1+	
3	C2	
4	GND	Ground.
5	OUT	
6	V <sub>BOOST</sub>	
7	IN	
8	V <sub>DD</sub>	

Pin No. (16-Pin SOIC Wide)	Symbol	Description
1	C1-	
2	NC	No connect.
3	C1+	
4	NC	No connect.
5	C2	
6	NC	No connect.
7	NC	No connect.
8	GND	Ground.
9	OUT	
10	NC	No connect.
11	V <sub>BOOST</sub>	
12	NC	No connect.
13	IN	
14	NC	No connect.
15	NC	No connect.
16	V <sub>DD</sub>	

## 3.0 APPLICATIONS INFORMATION

**FIGURE 3-1: INVERTING DRIVER SWITCHING TIME**



**FIGURE 3-2: NONINVERTING DRIVER SWITCHING TIME**



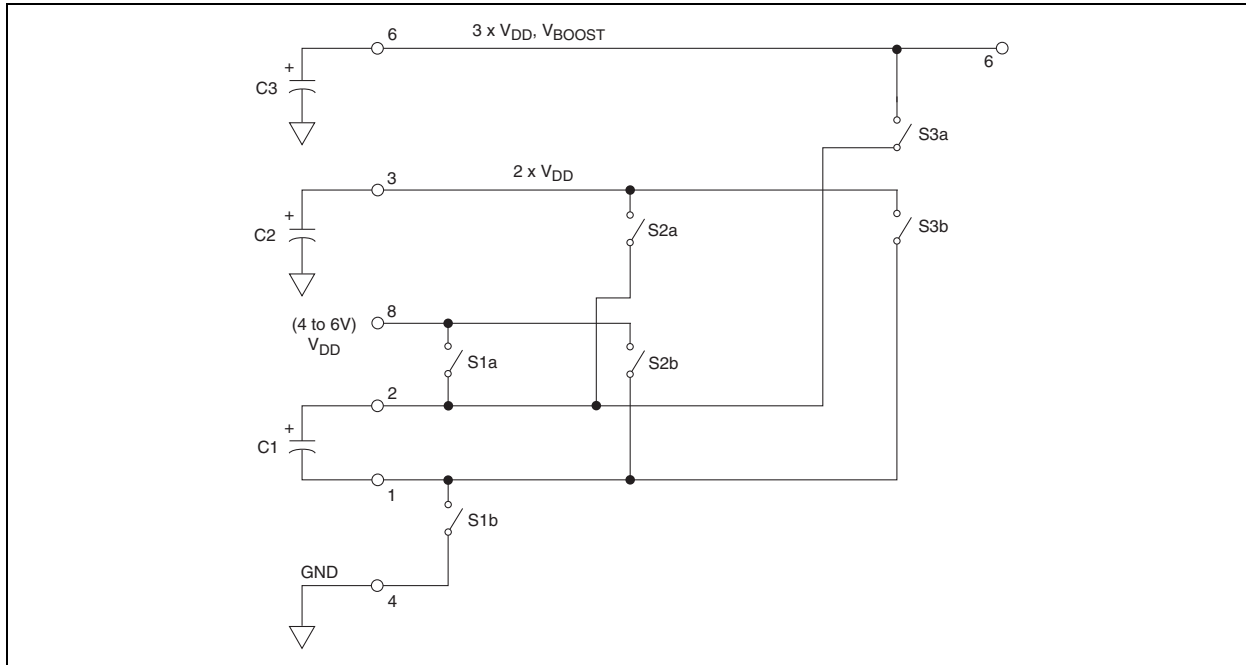
# TC4626/TC4627

## 3.1 BOOSTER FUNCTION

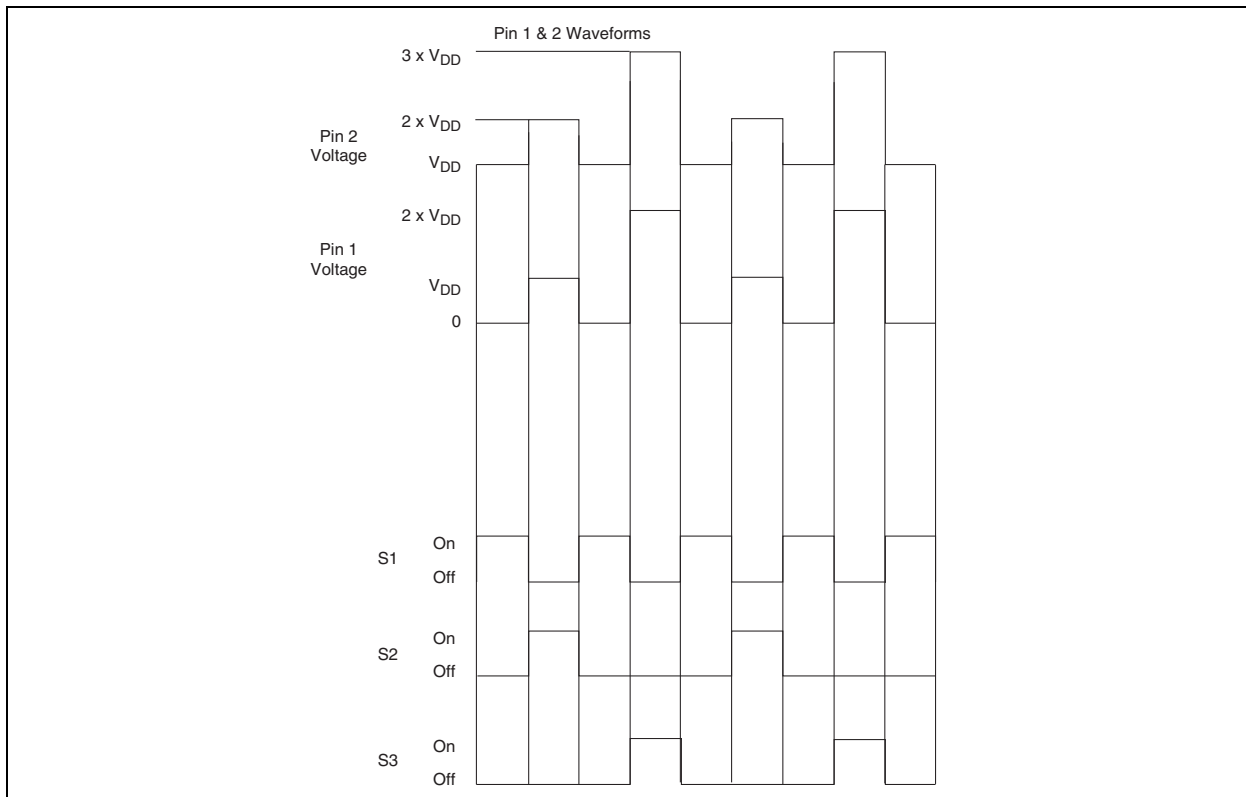
The voltage booster is an unregulated voltage tripler circuit. The tripler consists of three sets of internal switches and three external capacitors. S1a and S1b charge capacitor C1 to  $V_{DD}$  potential. S2a and S2b add

C1 potential to  $V_{DD}$  input to charge C2 to  $2 \times V_{DD}$ . S3a and S3b add C1 potential to C2 to charge C3 to  $3 \times V_{DD}$ . The position of the switches is controlled by the internal 4 phase clock.

**FIGURE 3-3: VOLTAGE BOOSTER**

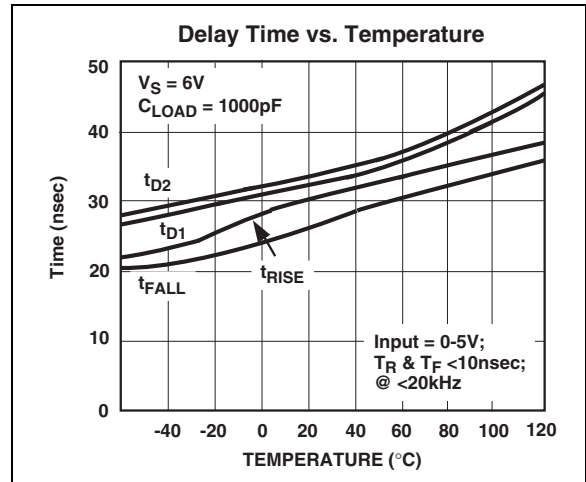
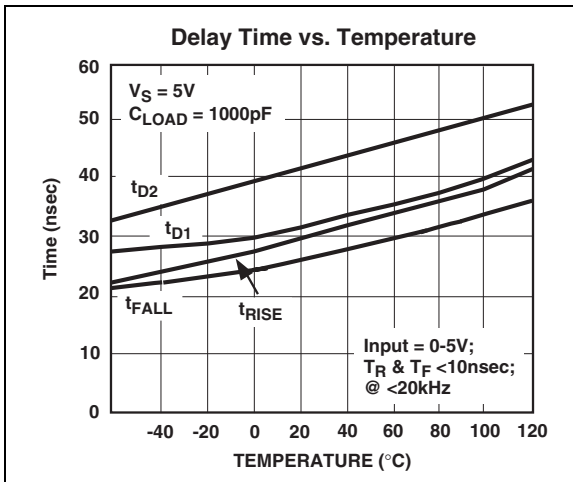
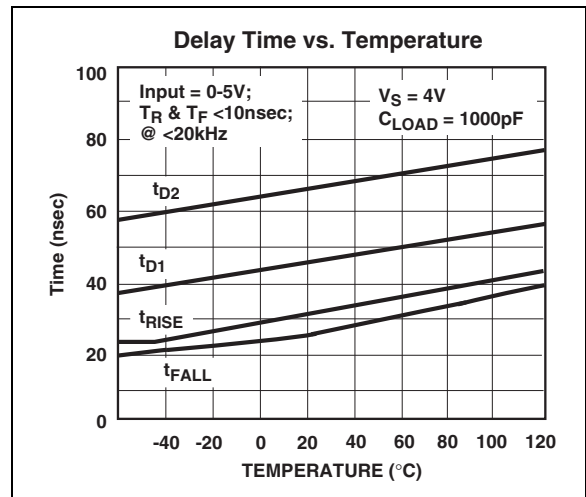
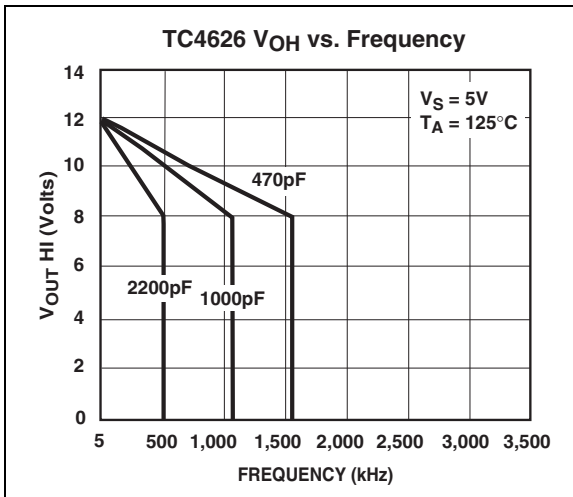


**FIGURE 3-4: POSITION OF SWITCHES**



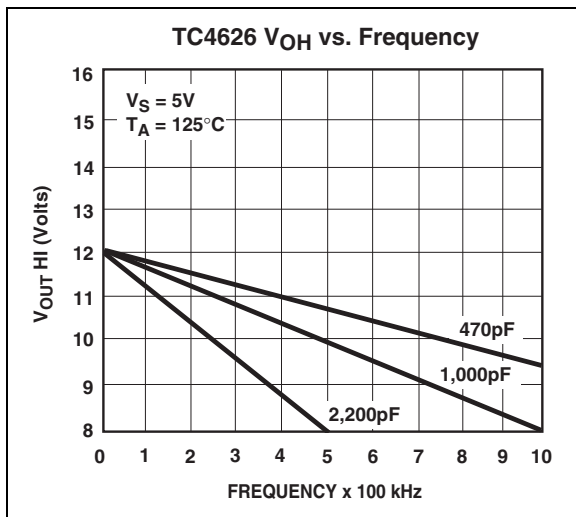
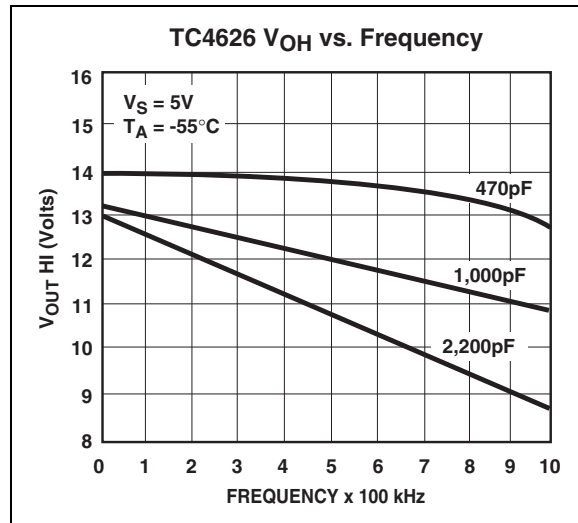
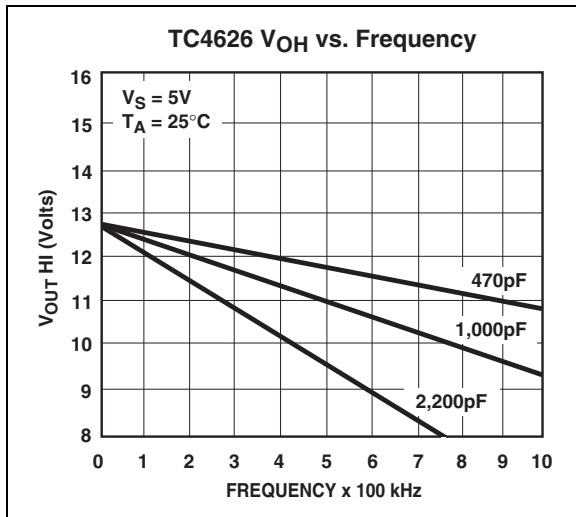
## 4.0 TYPICAL CHARACTERISTICS

**Note:** The graphs and tables provided following this note are a statistical summary based on a limited number of samples and are provided for informational purposes only. The performance characteristics listed herein are not tested or guaranteed. In some graphs or tables, the data presented may be outside the specified operating range (e.g., outside specified power supply range) and therefore outside the warranted range.



# TC4626/TC4627

## TYPICAL CHARACTERISTICS (CONTINUED)





## 5.0 PACKAGING INFORMATION

Package marking data not available at this time.

# TC4626/TC4627

## 5.1 Package Dimensions

**Note:** For the most current package drawings, please see the Microchip Packaging Specification located at <http://www.microchip.com/packaging>

### 8-Pin Plastic DIP



**Dimensions: inches (mm)**

## Package Dimensions (Continued)

**Note:** For the most current package drawings, please see the Microchip Packaging Specification located at <http://www.microchip.com/packaging>

### 8-Pin CDIP (Narrow)



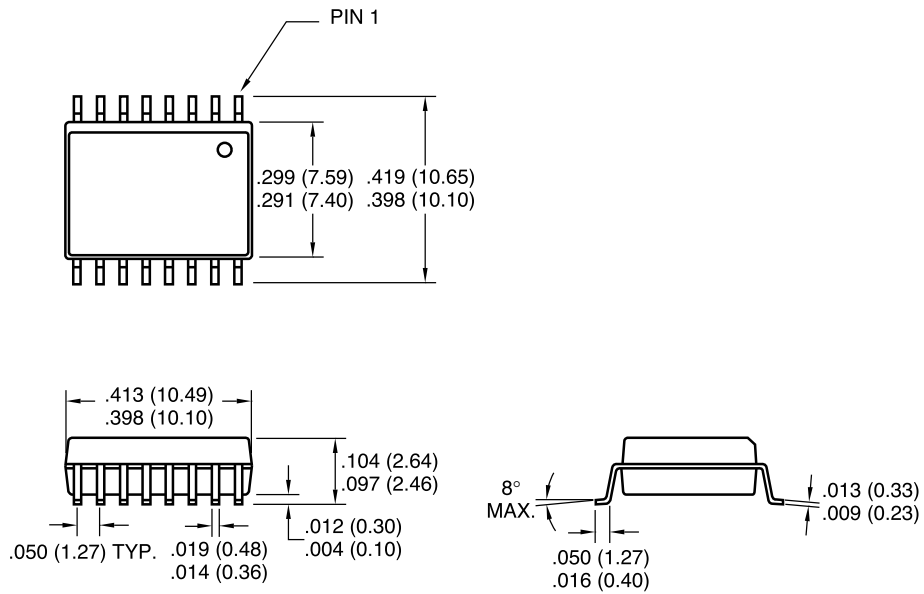
**Dimensions: inches (mm)**

# TC4626/TC4627

## Package Dimensions (Continued)

**Note:** For the most current package drawings, please see the Microchip Packaging Specification located at <http://www.microchip.com/packaging>

### 16-Pin SOIC (Wide)



Dimensions: inches (mm)

## 6.0 REVISION HISTORY

### Revision C (December 2012)

Added a note to each package outline drawing.



## **Sales and Support**

### **Data Sheets**

Products supported by a preliminary Data Sheet may have an errata sheet describing minor operational differences and recommended workarounds. To determine if an errata sheet exists for a particular device, please contact one of the following:

1. Your local Microchip sales office
2. The Microchip Worldwide Site ([www.microchip.com](http://www.microchip.com))

Please specify which device, revision of silicon and Data Sheet (include Literature #) you are using.

### **New Customer Notification System**

Register on our web site ([www.microchip.com/cn](http://www.microchip.com/cn)) to receive the most current information on our products.

# TC4626/TC4627

---

---

NOTES:



---

**Note the following details of the code protection feature on Microchip devices:**

- Microchip products meet the specification contained in their particular Microchip Data Sheet.
- Microchip believes that its family of products is one of the most secure families of its kind on the market today, when used in the intended manner and under normal conditions.
- There are dishonest and possibly illegal methods used to breach the code protection feature. All of these methods, to our knowledge, require using the Microchip products in a manner outside the operating specifications contained in Microchip's Data Sheets. Most likely, the person doing so is engaged in theft of intellectual property.
- Microchip is willing to work with the customer who is concerned about the integrity of their code.
- Neither Microchip nor any other semiconductor manufacturer can guarantee the security of their code. Code protection does not mean that we are guaranteeing the product as “unbreakable.”

Code protection is constantly evolving. We at Microchip are committed to continuously improving the code protection features of our products. Attempts to break Microchip's code protection feature may be a violation of the Digital Millennium Copyright Act. If such acts allow unauthorized access to your software or other copyrighted work, you may have a right to sue for relief under that Act.

---

Information contained in this publication regarding device applications and the like is provided only for your convenience and may be superseded by updates. It is your responsibility to ensure that your application meets with your specifications. MICROCHIP MAKES NO REPRESENTATIONS OR WARRANTIES OF ANY KIND WHETHER EXPRESS OR IMPLIED, WRITTEN OR ORAL, STATUTORY OR OTHERWISE, RELATED TO THE INFORMATION, INCLUDING BUT NOT LIMITED TO ITS CONDITION, QUALITY, PERFORMANCE, MERCHANTABILITY OR FITNESS FOR PURPOSE. Microchip disclaims all liability arising from this information and its use. Use of Microchip devices in life support and/or safety applications is entirely at the buyer's risk, and the buyer agrees to defend, indemnify and hold harmless Microchip from any and all damages, claims, suits, or expenses resulting from such use. No licenses are conveyed, implicitly or otherwise, under any Microchip intellectual property rights.

**Trademarks**

The Microchip name and logo, the Microchip logo, dsPIC, FlashFlex, KEELOQ, KEELOQ logo, MPLAB, PIC, PICmicro, PICSTART, PIC<sup>32</sup> logo, rPIC, SST, SST Logo, SuperFlash and UNI/O are registered trademarks of Microchip Technology Incorporated in the U.S.A. and other countries.

FilterLab, Hampshire, HI-TECH C, Linear Active Thermistor, MTP, SEEVAL and The Embedded Control Solutions Company are registered trademarks of Microchip Technology Incorporated in the U.S.A.

Silicon Storage Technology is a registered trademark of Microchip Technology Inc. in other countries.

Analog-for-the-Digital Age, Application Maestro, BodyCom, chipKIT, chipKIT logo, CodeGuard, dsPICDEM, dsPICDEM.net, dsPICworks, dsSPEAK, ECAN, ECONOMONITOR, FanSense, HI-TIDE, In-Circuit Serial Programming, ICSP, Mindi, MiWi, MPASM, MPF, MPLAB Certified logo, MPLIB, MPLINK, mTouch, Omniclient Code Generation, PICC, PICC-18, PICDEM, PICDEM.net, PICkit, PICtail, REAL ICE, rLAB, Select Mode, SQI, Serial Quad I/O, Total Endurance, TSHARC, UniWinDriver, WiperLock, ZENA and Z-Scale are trademarks of Microchip Technology Incorporated in the U.S.A. and other countries.

SQTP is a service mark of Microchip Technology Incorporated in the U.S.A.

GestIC and ULPP are registered trademarks of Microchip Technology Germany II GmbH & Co. & KG, a subsidiary of Microchip Technology Inc., in other countries.

All other trademarks mentioned herein are property of their respective companies.

© 2001-2012, Microchip Technology Incorporated, Printed in the U.S.A., All Rights Reserved.

 Printed on recycled paper.

ISBN: 9781620768006

**QUALITY MANAGEMENT SYSTEM**  
**CERTIFIED BY DNV**  
**== ISO/TS 16949 ==**

*Microchip received ISO/TS-16949:2009 certification for its worldwide headquarters, design and wafer fabrication facilities in Chandler and Tempe, Arizona; Gresham, Oregon and design centers in California and India. The Company's quality system processes and procedures are for its PIC<sup>®</sup> MCUs and dsPIC<sup>®</sup> DSCs, KEELOQ<sup>®</sup> code hopping devices, Serial EEPROMs, microperipherals, nonvolatile memory and analog products. In addition, Microchip's quality system for the design and manufacture of development systems is ISO 9001:2000 certified.*



# MICROCHIP

## Worldwide Sales and Service

### AMERICAS

**Corporate Office**  
2355 West Chandler Blvd.  
Chandler, AZ 85224-6199  
Tel: 480-792-7200  
Fax: 480-792-7277  
Technical Support:  
<http://www.microchip.com/support>  
Web Address:  
[www.microchip.com](http://www.microchip.com)

**Atlanta**  
Duluth, GA  
Tel: 678-957-9614  
Fax: 678-957-1455

**Boston**  
Westborough, MA  
Tel: 774-760-0087  
Fax: 774-760-0088

**Chicago**  
Itasca, IL  
Tel: 630-285-0071  
Fax: 630-285-0075

**Cleveland**  
Independence, OH  
Tel: 216-447-0464  
Fax: 216-447-0643

**Dallas**  
Addison, TX  
Tel: 972-818-7423  
Fax: 972-818-2924

**Detroit**  
Farmington Hills, MI  
Tel: 248-538-2250  
Fax: 248-538-2260

**Indianapolis**  
Noblesville, IN  
Tel: 317-773-8323  
Fax: 317-773-5453

**Los Angeles**  
Mission Viejo, CA  
Tel: 949-462-9523  
Fax: 949-462-9608

**Santa Clara**  
Santa Clara, CA  
Tel: 408-961-6444  
Fax: 408-961-6445

**Toronto**  
Mississauga, Ontario,  
Canada  
Tel: 905-673-0699  
Fax: 905-673-6509

### ASIA/PACIFIC

**Asia Pacific Office**  
Suites 3707-14, 37th Floor  
Tower 6, The Gateway  
Harbour City, Kowloon  
Hong Kong  
Tel: 852-2401-1200  
Fax: 852-2401-3431

**Australia - Sydney**  
Tel: 61-2-9868-6733  
Fax: 61-2-9868-6755

**China - Beijing**  
Tel: 86-10-8569-7000  
Fax: 86-10-8528-2104

**China - Chengdu**  
Tel: 86-28-8665-5511  
Fax: 86-28-8665-7889

**China - Chongqing**  
Tel: 86-23-8980-9588  
Fax: 86-23-8980-9500

**China - Hangzhou**  
Tel: 86-571-2819-3187  
Fax: 86-571-2819-3189

**China - Hong Kong SAR**  
Tel: 852-2943-5100  
Fax: 852-2401-3431

**China - Nanjing**  
Tel: 86-25-8473-2460  
Fax: 86-25-8473-2470

**China - Qingdao**  
Tel: 86-532-8502-7355  
Fax: 86-532-8502-7205

**China - Shanghai**  
Tel: 86-21-5407-5533  
Fax: 86-21-5407-5066

**China - Shenyang**  
Tel: 86-24-2334-2829  
Fax: 86-24-2334-2393

**China - Shenzhen**  
Tel: 86-755-8864-2200  
Fax: 86-755-8203-1760

**China - Wuhan**  
Tel: 86-27-5980-5300  
Fax: 86-27-5980-5118

**China - Xian**  
Tel: 86-29-8833-7252  
Fax: 86-29-8833-7256

**China - Xiamen**  
Tel: 86-592-2388138  
Fax: 86-592-2388130

**China - Zhuhai**  
Tel: 86-756-3210040  
Fax: 86-756-3210049

### ASIA/PACIFIC

**India - Bangalore**  
Tel: 91-80-3090-4444  
Fax: 91-80-3090-4123

**India - New Delhi**  
Tel: 91-11-4160-8631  
Fax: 91-11-4160-8632

**India - Pune**  
Tel: 91-20-2566-1512  
Fax: 91-20-2566-1513

**Japan - Osaka**  
Tel: 81-66-152-7160  
Fax: 81-66-152-9310

**Japan - Yokohama**  
Tel: 81-45-471-6166  
Fax: 81-45-471-6122

**Korea - Daegu**  
Tel: 82-53-744-4301  
Fax: 82-53-744-4302

**Korea - Seoul**  
Tel: 82-2-554-7200  
Fax: 82-2-558-5932 or  
82-2-558-5934

**Malaysia - Kuala Lumpur**  
Tel: 60-3-6201-9857  
Fax: 60-3-6201-9859

**Malaysia - Penang**  
Tel: 60-4-227-8870  
Fax: 60-4-227-4068

**Philippines - Manila**  
Tel: 63-2-634-9065  
Fax: 63-2-634-9069

**Singapore**  
Tel: 65-6334-8870  
Fax: 65-6334-8850

**Taiwan - Hsin Chu**  
Tel: 886-3-5778-366  
Fax: 886-3-5770-955

**Taiwan - Kaohsiung**  
Tel: 886-7-213-7828  
Fax: 886-7-330-9305

**Taiwan - Taipei**  
Tel: 886-2-2508-8600  
Fax: 886-2-2508-0102

**Thailand - Bangkok**  
Tel: 66-2-694-1351  
Fax: 66-2-694-1350

### EUROPE

**Austria - Wels**  
Tel: 43-7242-2244-39  
Fax: 43-7242-2244-393

**Denmark - Copenhagen**  
Tel: 45-4450-2828  
Fax: 45-4485-2829

**France - Paris**  
Tel: 33-1-69-53-63-20  
Fax: 33-1-69-30-90-79

**Germany - Munich**  
Tel: 49-89-627-144-0  
Fax: 49-89-627-144-44

**Italy - Milan**  
Tel: 39-0331-742611  
Fax: 39-0331-466781

**Netherlands - Drunen**  
Tel: 31-416-690399  
Fax: 31-416-690340

**Spain - Madrid**  
Tel: 34-91-708-08-90  
Fax: 34-91-708-08-91

**UK - Wokingham**  
Tel: 44-118-921-5869  
Fax: 44-118-921-5820

11/27/12

Компания «Life Electronics» занимается поставками электронных компонентов импортного и отечественного производства от производителей и со складов крупных дистрибьюторов Европы, Америки и Азии.

С конца 2013 года компания активно расширяет линейку поставок компонентов по направлению коаксиальный кабель, кварцевые генераторы и конденсаторы (керамические, пленочные, электролитические), за счёт заключения дистрибьюторских договоров

Мы предлагаем:

- Конкурентоспособные цены и скидки постоянным клиентам.
- Специальные условия для постоянных клиентов.
- Подбор аналогов.
- Поставку компонентов в любых объемах, удовлетворяющих вашим потребностям.
- Приемлемые сроки поставки, возможна ускоренная поставка.
- Доставку товара в любую точку России и стран СНГ.
- Комплексную поставку.
- Работу по проектам и поставку образцов.
- Формирование склада под заказчика.
- Сертификаты соответствия на поставляемую продукцию (по желанию клиента).
- Тестирование поставляемой продукции.
- Поставку компонентов, требующих военную и космическую приемку.
- Входной контроль качества.
- Наличие сертификата ISO.

В составе нашей компании организован Конструкторский отдел, призванный помогать разработчикам, и инженерам.

Конструкторский отдел помогает осуществить:

- Регистрацию проекта у производителя компонентов.
- Техническую поддержку проекта.
- Защиту от снятия компонента с производства.
- Оценку стоимости проекта по компонентам.
- Изготовление тестовой платы монтаж и пусконаладочные работы.



Тел: +7 (812) 336 43 04 (многоканальный)

Email: [org@lifeelectronics.ru](mailto:org@lifeelectronics.ru)